



GMS User Manual (v10.3)

Groundwater Modeling System

1. Learning GMS

What Is GMS

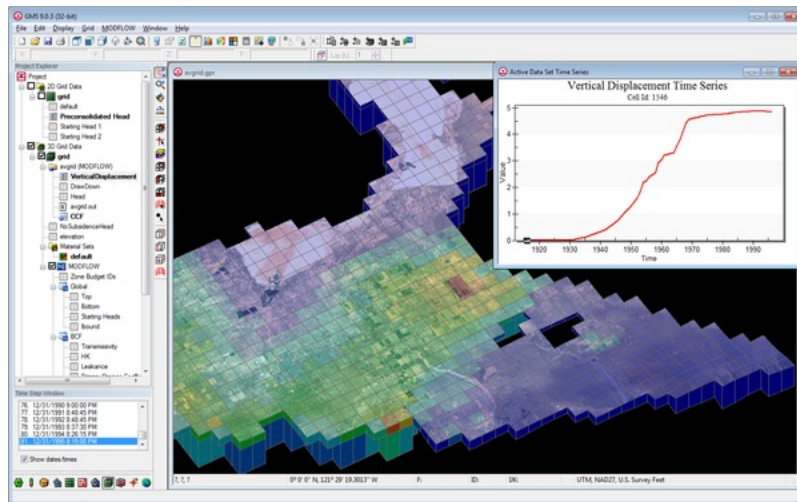

SUB package vertical displacement plot.

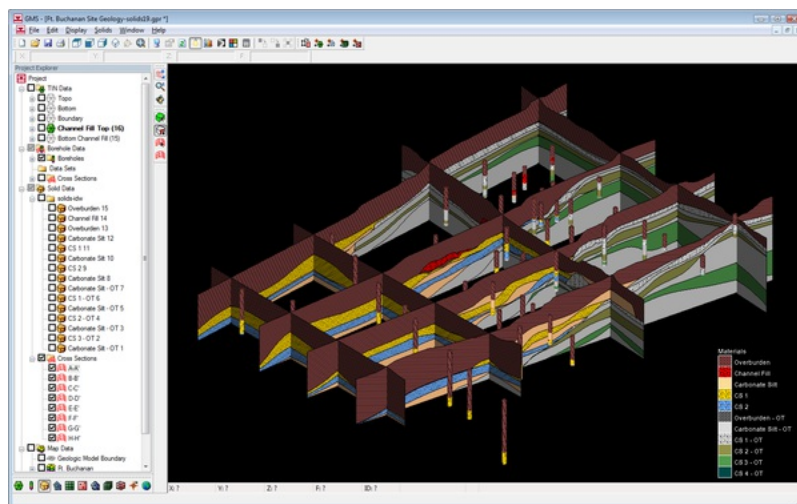

Solid cross sections and boreholes.

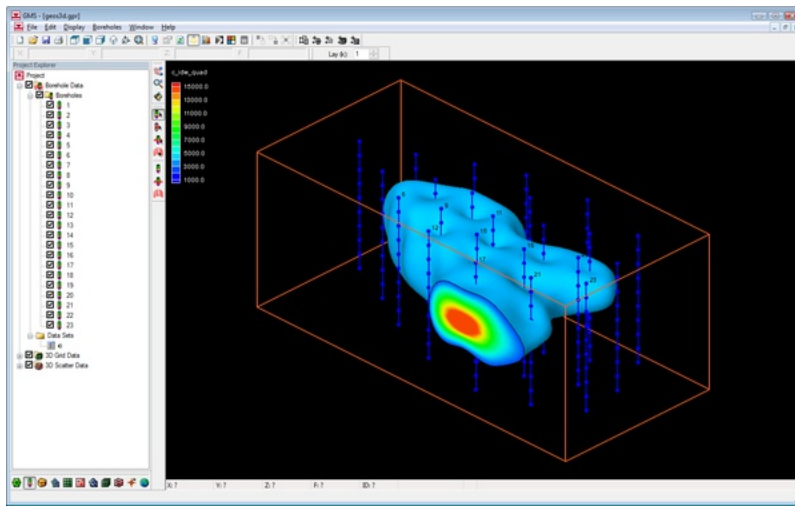













Isosurface on a 3D grid and borehole sample data.

The Groundwater Modeling System (GMS) is a comprehensive graphical user environment for performing groundwater simulations. The entire GMS system consists of a graphical user interface (the GMS program) and a number of analysis codes (MODFLOW, MT3DMS, etc.). The GMS interface is developed by Aquaveo, LLC in Provo, Utah.

GMS was designed as a comprehensive modeling environment. Several types of models are supported and facilities are provided to share information between different models and data types. Tools are provided for site characterization, model conceptualization, mesh and grid generation, geostatistics, and post-processing.

Modules

The interface for GMS is divided into twelve modules. A module is provided for each of the basic data types supported by GMS. As you switch from one module to another module, the **Dynamic Tool Palette** and the **Menus** change. This allows you to focus only on the tools and commands related to the data type you wish to use in the modeling process. The following modules are supported in GMS:

Icon	Module
	TIN Module
	Borehole Module
	Solid Module
	2D Mesh Module
	2D Grid Module
	2D Scatter Point Module
	3D Mesh Module
	3D Grid Module
	3D Scatter Point Module
	Map Module
	GIS Module
	UGrid Module

Numerical Models

Numerical models are programs that are separate from GMS that are used to run an analysis on a simulation. The simulation can be built in GMS, and then run through the numerical model program. GMS can then read in and display the results of the analysis.

The following numerical models are currently supported in GMS:

Model Name	GMS Module
MODFLOW MODPATH MT3DMS PEST PHT3D RT3D SEAWAT SEAM3D	3D Grid
MODAEM UTEXAS	Map Module
SEEP2D	2D Mesh
FEMWATER	3D Mesh
T-PROGS	Boreholes

Source code for most models is available upon request. Contact [technical support](#) to request source code.

What's New in GMS 10.3

The following is a list of the more significant changes that will be introduced in GMS 10.3.

1. MODFLOW

1. Support for preserving DISU data created outside of GMS
2. Map -> CLN
3. Update to PEST 14.0
4. Update to MODFLOW-NWT 1.1.2
5. Support for SYTP parameter type for HUF package
6. Zone flow for MODFLOW-USG ZoneBudget ([GMS Feature Request](#))
7. Mapping SFR2 to multiple surface layers ([GMS Feature Request](#))

2. MT3D-USGS

1. New model added to GMS

3. [mod-PATH3DU](#)

1. Support for version 1.1.0 including new Waterloo method and modified grid specification file
2. Support for DefaultIFACE
3. Model Checker added to find obvious model setup errors
4. Model Wrapper and automatic reading of the solution
5. Export options to save shapefiles of pathlines, pathline points, and polygon capture zones
6. Option to create starting locations from UGrid points or cell centers
7. Interface taken out of beta

4. UGrids

1. Display Options per UGrid
2. Split a UGrid layer ([GMS Feature Request](#))

5. New Tutorials

1. [mod-PATH3DU Transient tutorial](#)
2. [MT3D-USGS Tutorial](#)
3. [Shapefile to CLN](#)
4. [Recharge](#)

6. Miscellaneous

1. * Higher resolution bitmaps for use on higher resolution displays
2. Get Data Tool for downloading online data for a polygonal area
3. Improved 2D mesh generation
4. Change to dialog that asks about saving changes on File|New
5. Export 3D Grid layer contours to a shapefile.
6. New Empty UGrid 2D command for creating UGrids that points will be added to (like a TIN or 2D Scatter Set)
7. Notes ([GMS Feature Request](#))
8. Time format options ([GMS Feature Request](#))
9. Export multiple particle sets to shapefiles ([GMS Feature Request](#))
10. Include starting cell in pathline report for MODPATH, MP3DU ([GMS Feature Request](#))
11. TOB enhancements: iConcINTP set to 1 by default, add the well id to the comment lines in the header of the TOBS input file ([GMS Feature Request](#))
12. Reuse PEST Jacobian ([GMS Feature Request](#))
13. Option to export only active grid cells to shapefile ([GMS Feature Request](#))
14. Pathline arrows (time markers) to shapefile ([GMS Feature Request](#))

* In progress

The GMS Window

The GMS window is divided into seven main sections:

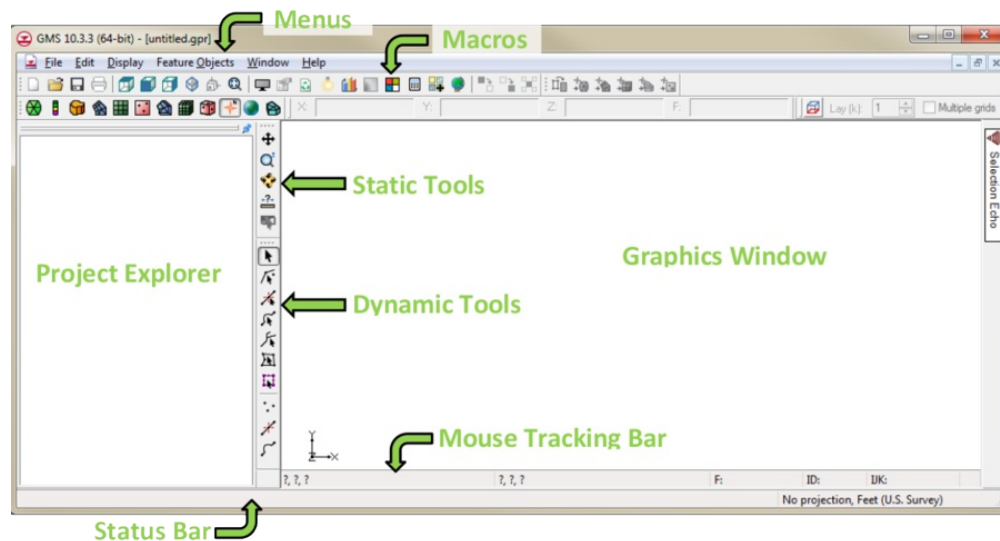

The GMS window with different parts labeled.

Menus

The [File](#), [Edit](#), [Display](#), [Window](#) and [Help](#) menus are always available. Other menus change based on the [module](#) or [numerical model](#) in use.

Toolbars

For a full description of all the toolbars, see [Toolbars](#).

Shortcut Toolbars

The [shortcut toolbars](#) are shortcuts (sometimes referred to as "macros") to often used menu commands.

Module toolbar

The module toolbar let's switching between [modules](#).

XYZF Bar

These fields are used to edit the coordinates and scalar data set values of selected items (vertices, nodes, scatter points, etc.).

X: 4770.0	Y: 9965.0	Z: 0.0	F:
-----------	-----------	--------	----

Project Explorer

The [Project Explorer](#) contains a hierarchical representation of the data associated with a modeling project.

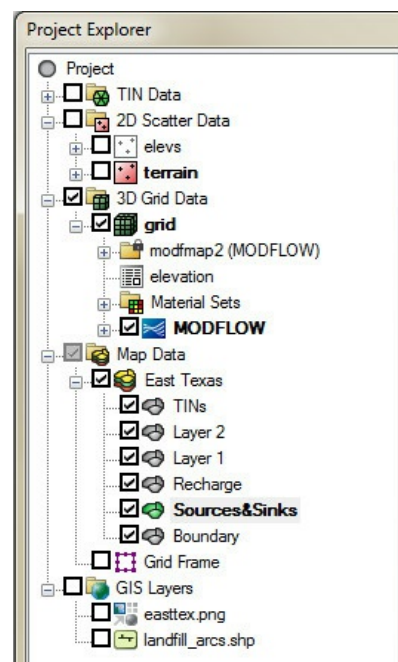

Example of the Project Explorer

Static and Dynamic Tools

The static and dynamic tools change the behavior of the mouse in the Graphics Window. The static tools are the same for every module and the dynamic tools change depending on the module. The dynamic tools typically are for creation or selection of objects.

Graphics Window

The Graphics Window is where data is rendered and data is manipulated using tools.

Mouse Tracking Bar

This shows the real world coordinates of the mouse in the Graphics Window. If the mouse is over a cell, triangle or element, the F value is the dataset scalar value and the ID is the object's number. For 3D Grids, the IJK of the cell is also shown. The progress bar is also found here.

Selection Echo

This allows quickly viewing the properties of a selected object, point, node, cell, or element.

Status Bar

The *Status Bar* is used to display messages and information about selected items. It also shows the [display projection](#).

15070.0, 33230.0, 0.0	F: 1005.675964355 ID: 1157	IJK: 17, 37, 1
Cell ID: 1156; Cell IJK i: 17, j: 36, k: 1; Material: material_1; Centroid x: 14897.22675367, y: 33165.954323059, z: 992.41670105463; Size i: 220.0, j: 200.0, k: 212 No projection, Feet (U.S. Survey)		

Time Steps Window

The *Time Steps* window is available only when a dataset containing a time series is active in the Project Explorer. The window allows selecting individual time steps for display in the Graphics Window. The window is usually located beneath the Project Explorer, but is can be resized and/or unpinned to be it's own window.

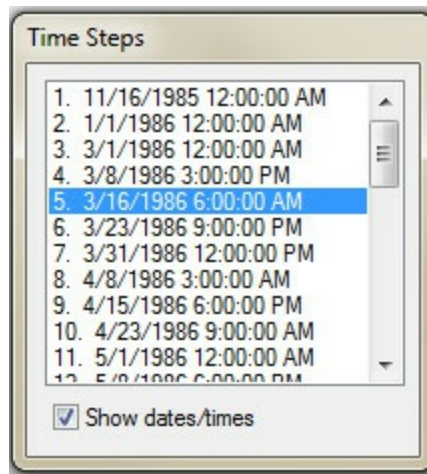

Example of the Time Steps window.

Toolbars

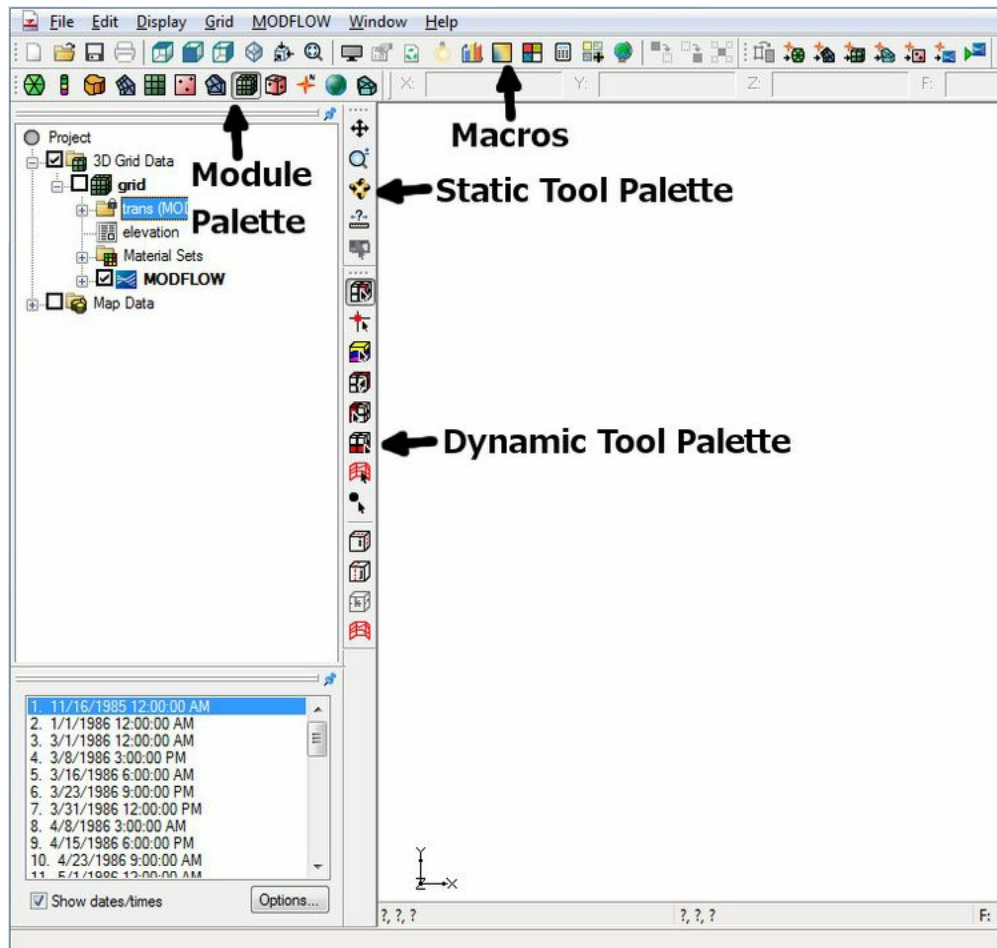

There are several toolbars that can be displayed in the GMS interface. Below are the toolbars that are on by default.





Basic Macros

Some of the more frequently used menu commands can be accessed through the macro buttons.









File Menu Macros

The following [File menu](#) commands appear as macros on this toolbar:

Icon	Command	Description
	New	Resets settings to the defaults and creates a new untitled project.
	Open	Brings up the <i>Open</i> dialog and allows an existing project or other file to be imported into GMS.
	Save	Brings up the <i>Save As</i> dialog. It allows the current project to be saved as a GPR file and a variety of other formats.
	Print	Brings up the <i>Print</i> dialog, allowing the contents of the Graphics Window to be printed to any printer supported by Windows.











Display View Macros

The following [Display menu](#) commands appear as macros in this toolbar. They can also be accessed by selecting either *Display* or *Display | View* and selecting the desired tool.

Icon	Command	Description
	Plan View	Changes the view to a top-down display, like on a blueprint.
	Front View	Changes the view to a front elevation display.
	Side View	Changes the view to a side elevation display.
	Oblique View	Changes the view to a 3D perspective.
	Ortho Mode	Changes to an orthogonal, or layer, view. This is only available when using the 3D Grid .
	Frame Image	Brings all the project extents within the boundaries of the Graphics Window.



Other Macros

The following [Display](#) and [Edit menu](#) commands appear as macros in this toolbar. They can also be accessed by selecting either *Display* or *Edit* and selecting the desired tool.

Icon	Command	Description
	Display Options	Brings up the <i>Display Options</i> dialog.
	Properties	Brings up the <i>Properties</i> dialog for the selected element.
	Refresh Display	Refreshes the Graphics Window.
	Use Light Source	Turns on or off the Lighting Options. The settings are accessible through the <i>Display Options</i> dialog (see above).
	Plot Wizard	Brings up the <i>Plot Wizard</i> dialog.
	Contour Options	Brings up the <i>Contour Options</i> dialog.
	Data Calculator	Brings up the <i>Data Calculator</i> dialog.
	Materials	Brings up the Materials dialog.
	Add Online Maps	Brings up the Get Online Maps dialog.
	Map Locator	Brings up the <i>Virtual Earth Map Locator</i> dialog.

Display Visibility Macros

The following [Display menu](#) commands appear as macros in this toolbar. They can also be accessed by selecting *Display | Visibility* and selecting the desired tool.



















Icon	Command	Description
	Hide	Toggles off the visibility of the selected elements.
	Show	Toggles on the visibility of the selected elements.
	Isolate	Toggles off the visibility of all but the selected elements.

Contextual Macros

These macros appear or disappear according to which options and models are enabled or disabled.

Map To Macros

Includes commands for building polygons, running models, and for the mapping feature objects to geometric objects or numerical models. The available macros will change depending on the available data and project setup.





Icon	Command	Description
	Build Polygons	Creates polygons out of closed arcs.
	Map to TIN	Creates a TIN using each polygon in the coverage.
	Map to 2D Mesh	Creates a 2D Mesh on the interior of all of the polygons in the current coverage.
	Map to 3D Grid	Opens the <i>Create Grid</i> dialog.
	Map to UGrid	Creates a UGrid from feature objects.
	Map to 2D Scatter	Creates a scatter point set from the points and nodes and vertices of the current coverage.
	Map to MODFLOW	Converts a conceptual model to a MODFLOW numerical model.
	Map to FEMWATER	Converts a conceptual model to a FEMWATER numerical model.
	Map to MT3DMS	Converts a conceptual model to a MT3DMS numerical model.
	Map to SEEP2D	Converts a conceptual model to a SEEP2D numerical model.
	Run MODFLOW	Initiates the MODFLOW executable.
	Run MODPATH	Initiates the MODPATH executable.
	Run FEMWATER	Initiates the FEMWATER executable.
	Run MODAEM	Initiates the MODAEM executable.
	Run MT3DMS	Initiates the MT3DMS executable.
	Run SEAWAT	Initiates the SEAWAT executable.
	Run SEEP2D	Initiates the SEEP2D executable.
	Run UTEXAS	Initiates the UTEXAS executable.

Tools

Static Tools

The *Static Tools* contain the tools which are available in every module. These tools are for basic operations such as panning and zooming. Only one tool is active at any given time.

The action that takes place when clicking in the [Graphics Window](#) depends on the current tool. The following table describes the tools in the *Static Tools*.

Tool	Tool Name	Description
	Pan	<p>The Pan tool is used to pan the viewing area of the Graphics Window. Panning can be done in 3 ways:</p> <ul style="list-style-type: none"> • When the Pan tool is active, holding down the main mouse button while dragging moves the view. • If another tool is active and not wanting to switch tools, pan by holding down the <i>F2</i> key and clicking and dragging with the mouse. • If the mouse has a middle button (or a mouse wheel), hold it down and drag to pan the view.
	Zoom	<p>The viewing area can be magnified/shrunk using the Zoom tool. Zooming can be done in the following ways:</p> <ul style="list-style-type: none"> • With the zoom tool selected, clicking on the screen zooms the display in around the point by a factor of two. Holding down the <i>SHIFT</i> key zooms out. • With the zoom tool selected, a rectangle can be dragged around a portion of the display to zoom in on that region. Holding down the <i>SHIFT</i> key zooms out. • If another tool is active and not wanting to switch tools, zoom by holding down the <i>F3</i> key and clicking and dragging with the mouse. • If the mouse has a mouse wheel, scroll the wheel to zoom in and out.
	Rotate	<p>The Rotate tool provides a quick way to rotate the viewing location. Rotating can be done in the following ways:</p> <ul style="list-style-type: none"> • With the rotate tool selected, holding down the mouse button and dragging the cursor in the Graphics Window rotates the object in the direction specified. A horizontal movement rotates the image about the z axis. A vertical movement rotates the image about the x and y axis. • If another tool is active and not wanting to switch tools, rotate by holding down the <i>F4</i> key and clicking and dragging with the mouse. <p>(The viewing angle can also be entered directly via the View Angle command in the Display Menu.)</p>
	Measure	<p>The Measure tool provides a quick way to measure distances.</p> <ul style="list-style-type: none"> • The tool is only available in plan view. • Measuring is done by selecting the tool and clicking on the Graphics Window with the mouse. A single line or a polyline can be created with a double-click used to end the line. The backspace key removes the last point clicked. • The distance from the last point and the total length are given at the bottom of the GMS window. The length units correspond to those selected in the Units dialog.

Dynamic Tools

When the active module is changed, the tools in the *Dynamic Tools* change to the set of tools associated with the selected object/module.



Mini-Grid Toolbar

The *Mini-Grid Toolbar* appears when a 3D grid exists and when the orthogonal viewing mode is active. In the orthogonal mode, the viewing angle is always parallel to one of the three grid axes (I, J, or K) and only one of the rows, columns, or layers is displayed at one time. The *Mini-Grid Toolbar* shows an idealized representation of the 3D grid and shows which of the rows, columns, or layers is currently being displayed. The current row, column, or layer can be changed using the arrows  on the *Mini-Grid Toolbar*.



Modules

The *Modules* toolbar is used to switch between modules. Only one module is active at any given time. Activating a module simply changes the set of available tools and menu commands.



See also

- [GMS Window](#)

Project Explorer

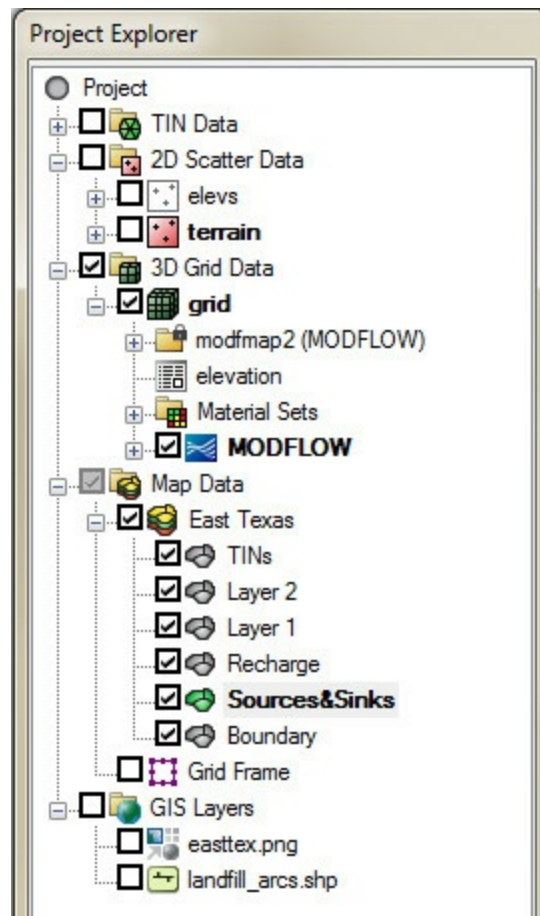

Example of the Project Explorer

The Project Explorer is located at the left side of the GMS window by default. It can be moved to anywhere on the window since it is a "dockable" toolbar. The Project Explorer contains a hierarchical representation of the data associated with a modeling project. Previously only the data from the active module was displayed in the Project Explorer, but now all of the data in GMS is always displayed independent of the active module. The new Project Explorer can also be resized by clicking on the window borders and dragging them to a new location.

All of the modules have root items corresponding to them. Each root item may be right-clicked on to accomplish certain actions. Data for each module is grouped into folders. The modules and items can also be expanded and collapsed to show sub folders. Each item

may also be turned on or off by clicking the check box next to the item. Many items in the Project Explorer can be dragged to different locations to be used with different modules. Items may also be duplicated.

Many commands on the data in GMS can be executed by right-click menus in the Project Explorer. For general commands or to create new data objects, right-click on the empty space in the Project Explorer and a pop-up menu becomes available. Right-click commands can also be used to export or transform items. The visibility of items in the Graphics Window can also be controlled by selecting the toggle next to each item in the Project Explorer.

Project Explorer Right-Click Commands

The following commands are available when right-clicking on an empty space in the Project Explorer.

New

This submenu will bring up a list of data objects. Selecting a data object in the list will create it in Project Explorer. Options include:

- [Display Theme](#)
- [TIN](#)
- [Borehole](#)
- [Solid](#)
- [2D Mesh](#)
- [2D Grid](#)
- [2D Scatter Point](#)
- [3D Mesh](#)
- [3D Grid](#)
- [3D Scatter Point](#)
- [Conceptual Model](#)
- [Coverage](#)
- [Grid Frame](#)
- [Annotation Layer – Screen Space](#)
- [Annotation Layer – World Space](#)
- [TProgs](#)
- [2D UGrid](#)
- [3D UGrid](#)

Collapse All

Collapses any data objects in the Project Explorer so they are hidden in the data object's parent object. Only data objects that are not contained in other data objects will be visible.

Expand All

Expands all data objects in the Project Explorer to show any data objects that are child objects inside a parent object.

Check All

Makes all data visible in the Graphics Window. This includes data that is currently hidden in the Project Explorer.

Uncheck All

Hides all data in the Graphic Window.

Convert to CAD

Converts any visible geometric data into CAD format internally within GMS.

Standard Project Explorer Folder Right-Click Commands

Right-clicking on a folder object in the Project Explorer produces a menu. The menu will have commands specific to the type of folder object, but the following standard menu commands are available:

New Folder

Creates a new folder  under the selected folder object.

Delete

Removes the selected object folder along with all data objects contained in that folder.

Collapse All

Collapses any data objects under the selected folder object so they are hidden.

Expand All

Expands all data objects under the selected folder object so they are visible.

Common Project Explorer Folder Right-Click Commands

The following commands are included in most folder object right-click menus:

Display Options

Opens the *Display Options* dialog showing the options for the folder object type.

Export

Saves all data objects under the selected folder object. The file type generated from this action will correspond to the folder object type.

Standard Project Explorer Data Object Right-Click Commands

Right-clicking on a data object in the Project Explorer produces a menu. The menu will have commands specific to the type of data object, but the following standard menu commands are available:

Delete ✖

Removes the selected data object from the GMS project.

Duplicate 📄

Creates a copy of the selected data object in the Project Explorer. The duplicate data object will have the word "Copy of..." affixed to the name of the copied data object. Additional duplicates will have a number affixed to the name if the copied data object is not renamed.

Rename

Allows assigning a new name to the selected data object.

Common Project Explorer Data Object Right-Click Commands

The following commands are included in the right-click menus for most data objects:

Projection

Submenu that has commands for setting the data objects projection. The following commands are available:

Projection

Brings up a *Projection* dialog to set the projection for the select data object.

Set as Display Projection

Assigns the selected data object's projection as the *display projection*.

Reproject

Brings up the *Reproject Object* dialog. This command does not work if no projection has been assigned to the selected data object.

Transform

Brings up the *Transform* dialog.

Export

Saves the selected data object as a file that corresponds to the data object type.

Properties

Brings up the *Properties* dialog that corresponds to the selected data object type.

Zoom to Extants

Brings all the data extents within the boundaries of the Graphics Window that is associated with the selected data object.

Functionality Notes

Due to a Windows design limitation, the right-click menu may not appear when right-clicking on unselected items that bring up the Time Steps window at the bottom of the Project Explorer. This happens in cases where the Project Explorer item being right-clicked overlaps the location where the Time Step window will appear. In these cases, the Time Step window appearing causes the right-click menu to not appear. To work around this problem, simply select the item first, and then right-click on it.

See also

- [GMS Screen](#)

Tutorials

A rich set of step-by-step tutorials has been developed to aid in learning how to use GMS. Current GMS tutorials can be found at the [GMS Tutorials](#) page (note the different tabs there for MODFLOW, MODFLOW Related, GMS, and Additional tutorials). Tutorials for older version of GMS are linked here below or at the bottom of the GMS Tutorials page. They come in PDF format with zipped data files specific to each tutorial. Additionally, the tutorial files are automatically installed with GMS in the "docs" or "tutfiles" directory in the program folder containing the GMS executable.

When tutorials require more advanced background knowledge found in other tutorials, the prerequisite tutorials will be noted in the beginning and should be completed beforehand. The amount of time needed to complete each tutorial varies from a few minutes to up to an hour.

Video tutorials are also available on the [GMS Learning Center – Videos](#) page.

Previous Versions

Tutorials are updated regularly as GMS is expanded and improved. Data and information in older tutorials may not apply to current versions of GMS.

To access previous versions of the GMS tutorials, see the article [Tutorial Archives](#).

Training Courses

Aquaveo conducts first-class training courses in water resources modeling on a continuing basis throughout the year. Instructors have many years of experience in software development of computer programs for scientific modeling and visualization.

Request GMS training courses at: www.aquaveo.com/training-courses

Aquaveo offers Continuing Education Units for each course to assist customers in meeting state registration board requirements for P.E. license renewal.

External Links

- [GMS Learning Center](#)

2. Set Up

64-bit

Starting with GMS 8.1, GMS is available in a 64-bit version. Using the 64-bit version, as opposed to the 32-bit version, has the following differences:

- GMS can access more RAM so larger models can be created
- A 64-bit version of MODFLOW is included and can be used by changing an option in the *Preferences* dialog
- *ArcObjects* is not available because [ESRI](#) has not created a 64-bit version

Registering GMS

When first installing GMS, it will be running in Demo Mode. All GMS functions will be enabled with the exception of printing and saving. Anyone can run GMS in Demo Mode on any computer and it can be freely distributed. To enable the print and save functions, either a password or a hardware lock is needed.

The components (modules, interfaces) can be licensed individually depending on the needs and interests of the user. The components of GMS are licensed using a password system. The **Register** command is used to enter a password that enables the licensed components. This command can be used to enable the program after initially installing GMS, or for adding additional modules to the program at a later time. The **Register** command must be used before any files can be saved or printed. Before registration, GMS will run in Demo Mode.

When the **Register** command is selected, the *Register* dialog appears. The first item shown in the dialog is the security string. This string is keyed to the hard drive of the computer where GMS is installed and uniquely identifies the computer. When first registering GMS, this security string should be reported to the distributor or reseller where GMS was purchased. The reseller then provides a password which should be entered in the edit field at the top of the dialog. Once the password is entered, the **Register** button is selected. If the security string was reported correctly and the password was entered correctly, the text next to each of the licensed components changes from "DISABLED" to "ENABLED".

The **Details** button brings up a dialog listing the phonetic code for the security string. When reporting the security string over the phone to get a password, using the phonetic code can be helpful in avoiding errors.

Once GMS has been registered, a file called gmspass.txt is created. Since GMS is licensed on a per/seat basis, arrangement must be made to get an additional password if GMS is to be moved to another computer.

Also, GMS can also be enabled using a hardware lock, rather than a password. Contact a GMS reseller for details.

Password

From the *Help* menu, select the **Register** command. This brings up the *Register* dialog, which has a "security string" listed at the top. Send this security string along with your name, company, phone number, and e-mail address to your vendor.

After verifying that you are a licensed user, a password will be sent. After receiving the password, enter it in the **Password** field in the *Register* dialog and click the **Register** button. The purchased modules will become enabled and GMS will run in Normal mode.

Hardware Lock

Follow the instructions you received with the hardware lock to install the hardware lock and accompanying drivers. If hardware lock instructions were not received, or they have been misplaced, they can be found in the \Utils\Hwlock\Instructions directory on the CD. There are separate files for single user and network hardware locks. These files can be read using a web browser. If you would like to purchase or have questions about hardware locks, please contact your vendor.

Community Edition

Starting at version 8.0 there is a free version of GMS called "Community Edition". It is limited to include only the [3D grid module](#) and the [MODFLOW](#) model interface. It is also restricted in the size of the grid and the number of MODFLOW stress periods. Any size model can be [imported](#), but if the grid exceeds 5000 cells or the number of stress periods is more than 3 the project cannot be saved and a watermark is displayed in the graphics window. The community edition must still be [registered](#) using a license code which can be obtained via the internet from the *Registration Wizard* (*Help | Register | Change Registration | **Get Community Edition License***).

Check to see if running in Community Edition mode by going to the *Registration* dialog. The size limits are displayed in the *About* dialog which is accessed through the **About** command in the *Help* menu.



GMS registration dialog showing that GMS is running in Community Edition mode.

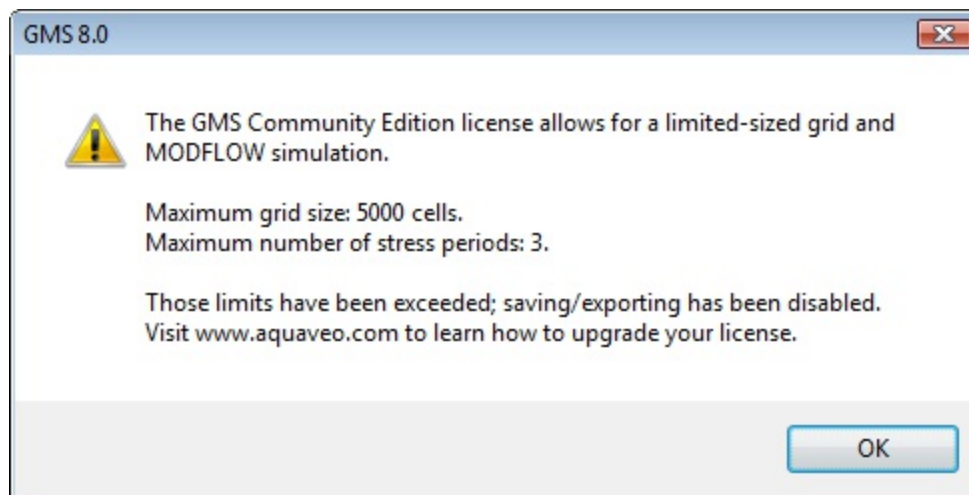

GMS Community Edition warning dialog.

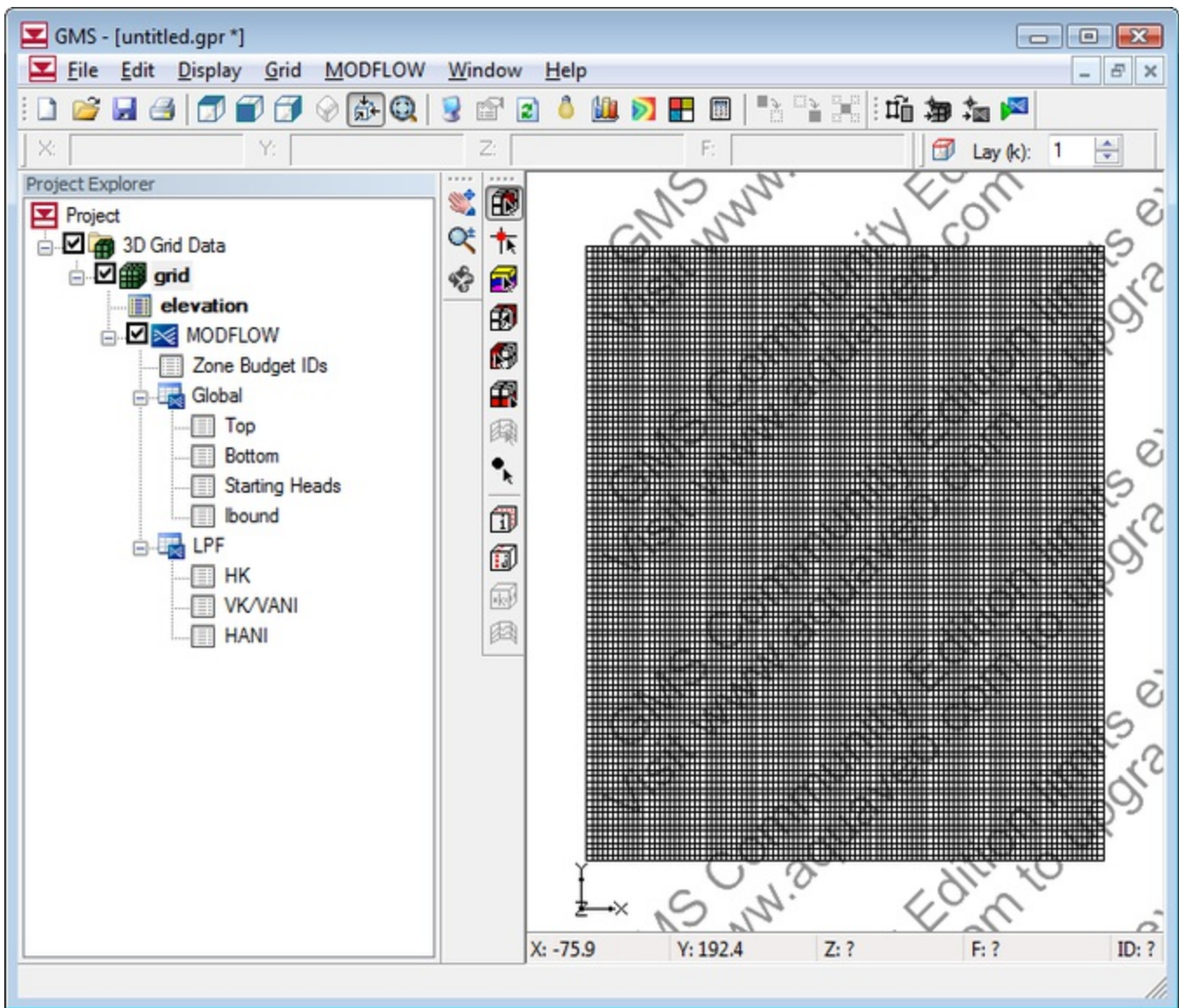

GMS showing watermark in Community Edition when size limits are exceeded.

The Community Edition capabilities are as follows:

Included Feature	Limitations
3D Grid Module	Limited to one grid that cannot be saved if it exceeds 5000 cells.
MODFLOW Interface	Limited to one simulation and cannot be saved if there are more than three stress periods.
Import CAD/GIS Data	
3D Viewing	
Import Images	
Simulation Setup	Limited to one simulation.
Mesh Generation Tools	Limited to one mesh. Excludes mesh quality checks and scalar paving.

Technical support is not provided for the Community Edition.

Graphics Card Troubleshooting

XMS (WMS, GMS, or SMS) use OpenGL for rendering graphics. OpenGL is a graphics standard, but each implementation is maintained by individual graphics card companies. Different graphics cards and drivers support different versions of the OpenGL standard. XMS currently uses features up to version 1.5 of OpenGL (as of April 2009 version 3.1 was most recent version).

Some graphics cards, as well as remote desktop, do not support functionality through OpenGL version 1.5. This is mostly a problem with older integrated graphics cards, in particular those manufactured by Intel. This page will give some ideas on troubleshooting these problems. The best solution is to get a graphics card that supports later versions of OpenGL. This provides improved performance as well as access all the features of XMS.

Remote Desktop

XMS (WMS, GMS, or SMS) will have reduced capability when running remote desktop. Since remote desktop only supports OpenGL version 1.1 not all of the features of XMS may be available.

1. One solution is to use a different remote control software that utilizes the graphics card of the computer being used. www.logmein.com has free and paid versions of remote desktop that behave better with XMS. RealVNC is a program that does this and can be purchased at a reasonable cost. There is a free version but it has not been tested with the XMS software. See [VNC Homepage](#) for more information.
2. Another solution is to use the Mesa software rendering option available in the application's graphic preferences. See the section below on OpenGL Graphics Dialogs for discussion of this option.

Parallels Desktop for Mac

XMS has reduced capability when running in a pure virtual PC through Parallels Desktop for Mac. Although Parallels version 6.0 provides OpenGL version 2.1 support (instead of OpenGL version 1.1) when "Enable 3D acceleration" is selected in the virtual machine's hardware configuration, the Parallels virtual video card adapter does not render all XMS graphics correctly. The solution is to use the Mesa software rendering option available in XMS's graphic preferences. See the section below on OpenGL Graphics Dialogs for discussion of this option.

If running XMS in a virtual PC utilizing a Boot Camp partition then Parallels uses the actual graphics card installed in the Mac. See sections below regarding graphics card issues.

OpenGL Graphics Dialogs

XMS (post WMS 8.2, GMS 7.0 onward, and SMS 10.1 onward) have dialogs that allow the selection of OpenGL support. The choice is between the system default library and the Mesa software library. The system default can change based upon current conditions such as a remote login. Not all system defaults support all needed graphics functionality. Therefore Mesa is provided for better functionality at a potential reduction in speed. However, Mesa may produce poor images when printing. This trade off can be made in the graphics dialog found in [preferences](#). The dialog provides 4 options so that on subsequent runs XMS will:

1. Ask which graphics library to use if the system does not support all OpenGL functionality needed by XMS. This option is initially set and gives the following options:
 1. Autoselect the Mesa software library for this run if the system default does not support all functionality. XMS will not prompt on subsequent runs. It will just check support and select a library.
 2. Use the system default library on this run (and on future runs if the "Do not ask again box" is checked).
 3. Use the Mesa software library on this run (and on future runs if the "Do not ask again box" is checked).
2. Autoselect the Mesa software library if the system default does not support all functionality.
3. Always use the system default library.
4. Always use the Mesa software library.

Determining Graphics Card Manufacturer

Always download and install the latest drivers from the graphics card vendor. Graphics card problems are often due to using the wrong or outdated drivers. A simple diagnostic program such as [DxDiag](#) can be used to determine the computer's hardware, operating system, and graphics card. To use the DxDiag program:

1. Select **Start**
2. Choose **Run**.
3. Type "dxdiag" in the box and click *OK*.'
4. Click **Yes** to the prompt, and the program will begin running.
5. Select the *Display* tab and the Name listed under the "Device" section is the name of the graphics card.

Another method:

1. Right-click on the desktop and select **Properties**
2. In the *Display Properties* dialog, click on the *Settings* tab
3. The video card manufacturer and chipset is shown below the "Display:" line
4. Look for the names NVIDIA, ATI, Intel, Matrox, SiS, S3, etc.

Updating Laptop Graphics Card Drivers

If using a laptop, visit the laptop manufacturer's website ([Dell](#), [HP or Compaq](#), [Toshiba](#), [Sony](#), etc.) to get the most recent driver.

Updating Desktop Graphics Card Drivers

If using a desktop computer, visit the graphics card manufacturer's website to download the latest driver. Listed below are a few common graphics cards and links to download their drivers:

- [3DLabs](#)
- [ATI](#)
- [Diamond](#)
- [Elsa](#)
- [Intel](#)
- [Matrox](#)
- [nVidia](#)
- [S3](#) – Not all S3 card support OpenGL 1.5 which is required for all display options to be enabled.
- [SIS](#) – Not all SIS card support OpenGL 1.5 which is required for all display options to be enabled.
- [VIA](#) – Not all VIA card support OpenGL 1.5 which is required for all display options to be enabled.

Updating Windows Operating System

Many problems are resolved by keeping the windows operating system and hardware drivers up to date using the [Windows update site](#). Hardware updates are often only installed if the "Custom" or "Optional" updates are included.

Updating XMS Software

Many problems are resolved by installing the latest version of XMS. Bugfixes and updates are released frequently. The updates can be downloaded at the [Aquaveo Download Center](#).

Known Graphics Issues

- Issue: Graphic symbols are not displayed correctly and sometimes corrupt text lines located next to them.

Hardware: Make: ATI Technologies Inc. Model: RADEON X600 PRO (0x5B62) Name: ATI Radeon X300/X550/X1050 Series

Solution: Updating the driver will allow the symbols to display correctly, but the text corruption still remains.

Switch from Hardware to Software Rendering

THE FOLLOWING SHOULD BE ATTEMPTED ONLY IF THE OTHER SOLUTIONS PRESENTED DO NOT RESOLVE THE DISPLAY ISSUES

If still having problems after updating the graphics drivers, download this [opengl32.dll ZIP file](#) and unzip the "OpenGL32.dll" and the "Glu32.dll" file to the directory where XMS is installed. Close and re-open XMS so this DLL is used for displaying XMS objects. Placing these DLL's in the XMS directory will fix most graphics-related issues, such as problems with displaying triangles on large TIN or DTM datasets and other problems with displaying large amounts of data. The following are known disadvantages to using this DLL for displaying:

- Displaying graphics using this DLL will likely be slower since software is used to display the graphics instead of the computer's graphics hardware. Panning, zooming, and rotating operations will be significantly slower.
- Some entities, such as symbols, are currently not displayed correctly when using this DLL. Only squares and circles will be displayed. Changing all symbol display options to squares or symbols is a work around for this problem. We are currently working on trying to fix this problem of symbols not displaying when using this DLL. (THIS PROBLEM HAS NOW BEEN FIXED IN SOME BETA VERSIONS OF XMS COMPILED AFTER March 31, 2009) In general, do not want to use this DLL unless working with large datasets that have display issues where XMS closes unexpectedly.

Contacting Support

If problems persist after updating the graphics card drivers, contact [support](#).

See also

- [System Requirements](#)
- [Introduction to Setting up SMS](#)

External Links

- [Aquaveo Technical Support](#)

Report A Bug

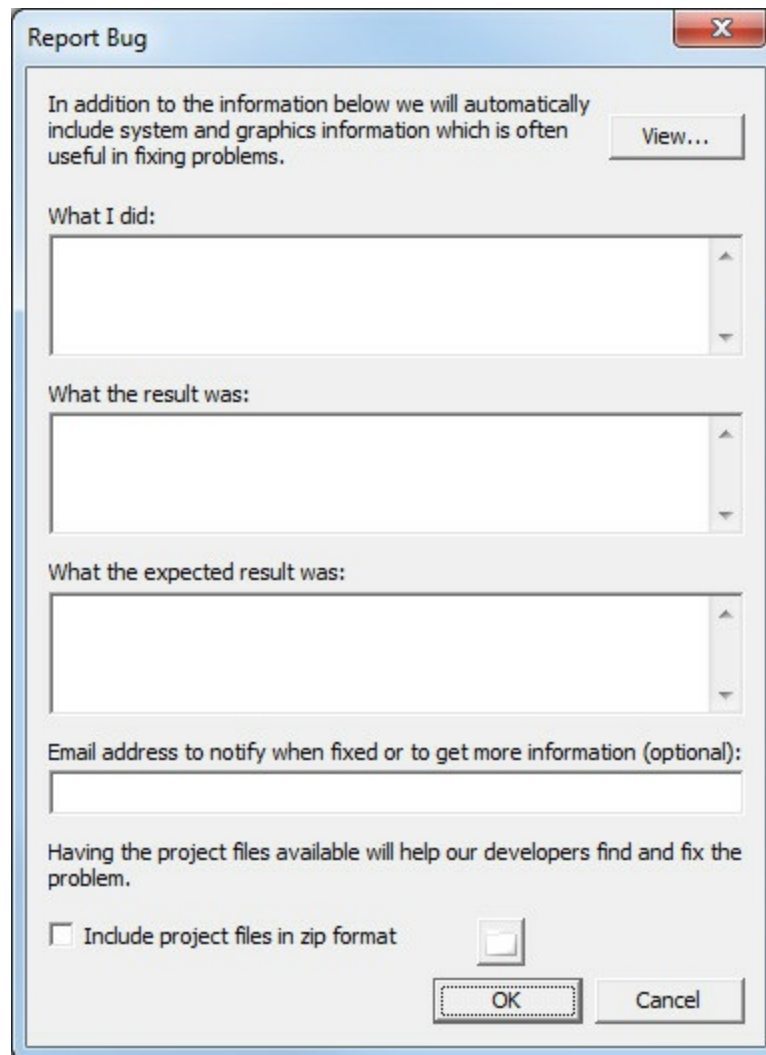

Report Bug

In addition to the information below we will automatically include system and graphics information which is often useful in fixing problems. View...

What I did:

What the result was:

What the expected result was:

Email address to notify when fixed or to get more information (optional):

Having the project files available will help our developers find and fix the problem.

Include project files in zip format 📁

OK Cancel

Example of the Report Bug dialog.

While Aquaveo and its developers work hard to keep problems in GMS to a minimum, some bugs or defects may occasionally surface. Reporting bugs helps Aquaveo and its developers resolve these issues. GMS must be connected to the internet in order to report a bug.

Some bugs in GMS are reported automatically to Aquaveo. This is done through bug trap software included in GMS. Automatic bug reports typically happen whenever GMS crashes.

Bugs can also be reported by users. It is advisable to first check [Bugfixes GMS](#) and the Aquaveo's [Support Forums](#) to see if the bug has already been reported. To report a new

bug, go to the *Help* menu and select the **Report Bug** command. Activating this command will bring up the *Report Bug* dialog.

Report Bug Dialog

When reporting a bug, complete as many of the sections of the *Report Bug* dialog as possible. The more information the developers have the more likely the situation can be resolved in a timely manner.

- *System Information*

GMS will deliver a text file that gives the configuration of GMS on the computer where the bug was reported. Clicking on the button will bring up this text file which shows what information is being sent.

- *What I did*

Write in this section a brief description of the actions that were being done when the bug occurred.

- *What the result was*

In this section, briefly explain the evidence of the bug in GMS.

- *What the expected result was*

It is best to not assume that the developers will understand what should have appeared instead of the bug. Briefly state what should have occurred had the bug not occurred.

- *Email address*

Provide an email address so that Aquaveo can follow up on the reported bug. Emails in bug reports are kept private and are not sold or used in marketing.

- *Project files*

It can be helpful to include project files of the project being worked on when the bug occurred. This will help determine if the bug is related to GMS or if it is a problem with the project files. Include all files in a single ZIP file. Use the browser button to attach the ZIP file to the bug report.

After completing this dialog, pressing **OK** will send the information to Aquaveo, LLC. An internet connection must be available and active for this information to be received.

After Submitting a Bug

After a bug has been submitted, Aquaveo will review the reported bug. Whenever possible, the bug will be resolved as quickly as possible. There is no time frame for when a bug will be resolved—some are resolved within hours while others may not be resolved for many months.

In some cases, a bug cannot be resolved by Aquaveo, this is particularly true in cases where the bug has been caused by user error or if the bug is caused by third-party software used by GMS.

Not all users will be contacted once a bug is resolved. It is recommended to contact Aquaveo's [technical support](#) if there are further concerns.

3. General Tools

3.1. The File Menu

File Menu

The *File* menu is one of the standard menus and is available in all of the [modules](#). The commands in the *File* menu are used for file input and output for the basic GMS file types, for printing, and to exit the program. The following commands are contained in the *File* menu:

New

Deletes all data associated with all data types and all modules. It resets the status of the program to the default state that is set when the program is first launched. This command should be selected when an entirely new modeling problem is started.

Open

This command is used to read in project files and to import data or other files generated outside of GMS.

Add Online Maps

Allows importing data such as imagery and DEM data from the internet.

Save

Used to save GMS projects. A project contains all of the files associated with a modeling project. When a GMS project is saved, all files associated with the data currently in memory are saved. This includes any model simulations which are open. By default the model simulation will be saved to the same location as the project.

However, in the *Save* dialog the path for the model simulation can be specified.

Save As

Used to designate the path for saving a GMS project. It can also be used to [Export](#) data.

Edit File

Prompts for the name of a file and opens the file in the chosen program. This command is used to edit model input files or to view output files. Output files that are part of a [Solution](#) can also be viewed by double-clicking on the text file in the [Project Explorer](#).

Settings...

This command can be used to change the default settings (display options, units etc)

applied to all new projects. For example, if wanting new projects to have particular settings, set those up in *GMS* and then use the **Settings** command to save the *Current settings* as the defaults to be used in the future. It is also possible to stop using defaults that were set previously and restore the defaults to the *Factory defaults*. There is only one set of default settings.

Page Setup

Launches the *Page Setup* dialog. The *Page Setup* dialog contains 3 tabs: Margins, Options, and Paper Size. The *Options* tab allows specifying the printing scale. The *Paper Size* tab allows selecting the paper size and source. Also, the orientation, portrait or landscape, can be selected. The *Margin* tab allows changing the Margins. On the right side of each tab is a print preview.

Print

Printed copies of the current *GMS* image are generated with this command. This launches the standard Windows *Printing* dialog.

Layout

Launches the *XMS Layout* dialog for defining print layouts.

Recent File List

Near the bottom of the *File* menu is a list of recently opened projects. As many as five different files can be in the recent file list.

Exit

Terminates the program.

Related Topics

- [GMS Menus](#)

XMS Print Layout

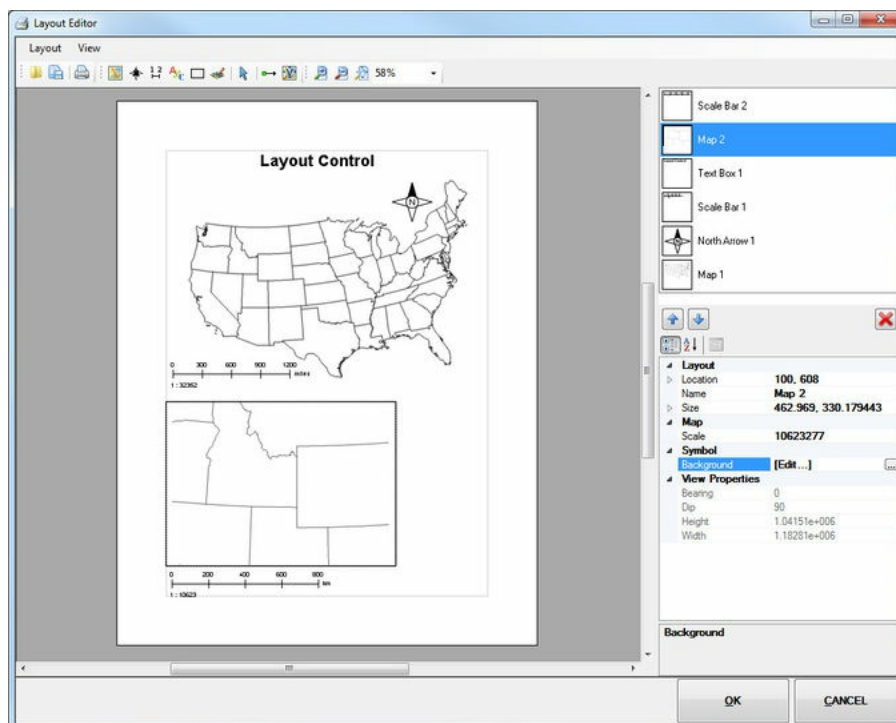

Example of the Layout Editor dialog.

The *Layout Editor* dialog, accessible by selecting *File | Layout...*, allows information from the XMS Main Graphics Window to be assembled and exported for use in reports and presentations.

Layout Editor Description

Below is a brief explanation of the macros, tools, and menus found in the *Layout Editor* dialog.

Layout Editor Menus

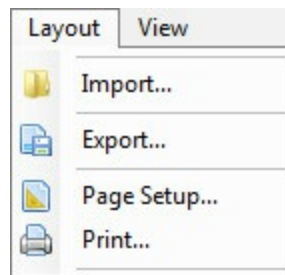

File menu in the XMS Layout dialog.

File menu items:

- **Import...** – Brings up the *Open* dialog, allowing importing of a saved layout (*.mwl).
- **Export...** – Brings up the *Save As* dialog, allowing savings of the layout in a user-specified folder.
- **Page Setup...** – Brings up the *Page Setup* dialog to allow setting of the paper size, orientation, and margins.
- **Print...** – Brings up the *Print* dialog, allowing printing of the layout to the desired printer.

View menu items:

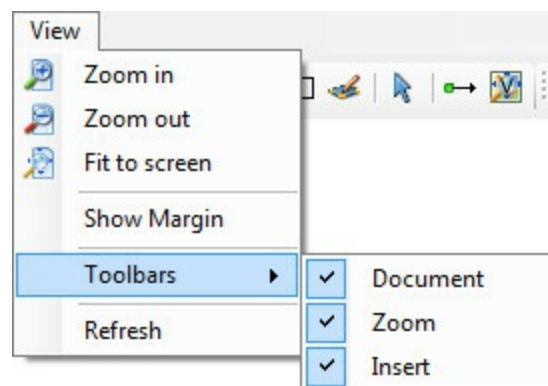



View menu

- **Zoom in** – Magnifies for a closer, more-detailed view.
- **Zoom out** – Shrinks the view to be farther out and less-detailed.





- **Fit to screen** – Zooms in or out to show the entire page in the main layout window.
- **Show Margin** – Shows or hides the margin guide in the main layout window.
- *Toolbars* – Opens a submenu with the following options:
 - **Document** – Shows or hides the [Document Toolbar](#).
 - **Tool** – Shows or hides the [Tool Toolbar](#).
 - **Zoom** – Shows or hides the [Zoom Toolbar](#).
- **Refresh** – Redraws the main layout window to the current settings.





Document Toolbar

- **Import...**  – Brings up the *Open* dialog, allowing importing of a saved layout (*.mwl).
- **Export...**  – Brings up the *Save As* dialog, allowing savings of the layout in a user-specified folder.
- **Print...**  – Brings up the *Print* dialog, allowing printing of the layout to the desired printer.



Tool Toolbar

Each of these tools places objects in the main layout window by selecting the desired tool, then clicking and dragging to select the area where the object is to be placed. Once the mouse button is released after clicking and dragging, the desired object is immediately placed within the selected area.

- **Insert map**  – Inserts the current content of the XMS Main Graphics Window into the selected area in the main layout window.
- **Insert north arrow**  – Inserts a north arrow into the selected area in the main layout window.
- **Insert scale bar**  – Inserts a scale bar into the selected area in the main layout window.
- **Insert text:**  – Inserts a text box into the selected area in the main layout window.

- **Insert rectangle**  – Inserts a rectangle into the selected area in the main layout window.
- **Insert bitmap**  – Inserts a bitmap into the selected area in the main layout window.
- **Select tool**  – Used to deselect the current tool.
- **Update Current View**  – Updates the selected map object based on the current view from the XMS Main Graphics Window.
- **Zoom map to extent of data view**  – Adjusts the size of the map image to fit within the extents of the map object box containing the image.

Zoom Toolbar



- **Zoom in**  – Magnifies for a closer, more-detailed view.
- **Zoom out**  – Shrinks the view to be farther out and less-detailed.
- **Fit to screen**  – Zooms in or out to show the entire page in the main layout window.
- *Percentage* field – Changes the the given zoom level. This is populated with common percentages, but can also be manually changed by clicking in the white area and entering a positive integer.

When the *Layout Editor* dialog is closed, the layout is saved in its current state to a temporary folder. When the project is saved, the temporary layout file is saved as a part of the project file. If a project has a layout associated with it, that layout will be loaded into the *Layout Editor* dialog when it is opened. Otherwise, a blank layout will be shown.

Objects List





Objects list

After inserting any object into the *Layout Editor* dialog, the object can be selected using the objects list section in the upper right portion of the window. The objects list displays all objects that have been inserted into the layout. Select an object to make it active by clicking directly on the listed object or by using the *Up* and *Down* keys on the keyboard to cycle through each object in the list. The display order of the objects can be adjusted using the **Up** or **Down**   arrow buttons. Clicking the delete  button will immediately remove the object from the object list.

Object Properties

The lower right portion of the objects list shows the properties of the active (or selected) object. The properties can be sorted using the following command buttons:

- **Categorize**  – Places the properties in categories such as "Layout", "Map", and "Symbol". The options in each category relate to the category title.
- **Alphabetical**  – Displays all properties alphabetically from A–Z without grouping them into categories.

General Properties

All objects have the following properties in common:

- *Location* – This field present two editable numbers. The first number is the *X*-axis location of the object. Increasing the *X* number moves the object to the right. The second number is the *Y*-axis location of the object. Increasing the *Y* number moves the object down. This property can be expanded to more clearly see the *X* and *Y* numbers.
- *Name* – This editable field shows the currently-selected object's name.
- *Size* – This field present two editable numbers. The first number is the width of the object. Increasing the *Width* number expands the object to the right and decreasing the number shrinks the the size of the object toward the left edge. The second number is the height of the object. Increasing the *Height* number expands the object down and decreasing the number shrinks the size of the object toward the top edge. This property can be expanded to more clearly see the *Width* and *Height* numbers.
- *Background* – Clicking on the  button in this field, the [Polygon Symbolizer Properties](#) dialog is brought up.

Map

The **Insert map**  tool is used to place the current image in the XMS Main Graphics Window into the *Layout Editor* dialog. The tool is used by clicking and dragging in the *Layout Editor* to define the area where the map will be displayed. The editor will automatically resize and scale the image to the defined area.

The display of the editor can further be edited by adjusting the map properties. The map objects use general properties and the follow map object specific properties:

- *Scale* – Adjusts the size of the image inside of the map object. Increasing this value with decrease the size of the image. Decreasing the value will increase the image size.
- *Bearing* – The degree away from North of the original image in the XMS Main Graphics Window.
- *Dip* – The angle of descent relative to a horizontal plane of the image in the XMS Main Graphics Window.
- *Height* – The original height of the image in the XMS Main Graphics Window.
- *Width* – The original width of the image in the XMS Main Graphics Window.

North Arrow

▾ Layout	
▷ Location	738, 80
Name	North Arrow 1
▷ Size	68.8244, 65.1041641
▾ Symbol	
Background	[Edit...]
Color	■ Black
Map	Map 1
NorthArrowStyle	Default
Rotation	0

Properties of the north arrow

The **Insert North Arrow**  tool inserts in the selected location a north arrow associated with a specific map object. When a map gets rotated, the north arrow changes its rotation angle based on the map's bearing angle.

The following are the properties of the north arrow:

- *Color* – Contains a drop-down list of colors. Selecting a color will change the color of the north arrow object.
- *Map* – This field contains a dropdown list of all map objects in the Layout Editor. Selecting a map object assigns the north arrow to that map. When assigned, the arrow will rotate to match show north on the map.
- *North Arrow Style* – A drop-down list of north arrow styles. Styles include: "Default", "Black Arrow", "Center Star", "Triangle N", "Triangle Hat", and "Arrow N".



Examples of north arrow styles

- *Rotation* – Changes the rotation of the north arrow. Normally, the arrow rotation matches the map bearing.

Scale Bar

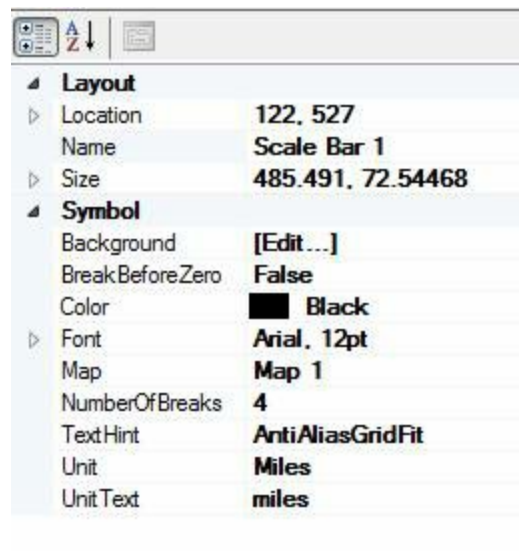

Properties of the scale bar

The **Insert Scale Bar**  tool inserts in the selected location a scale bar associated with a specific map object. The scale of the scale bar and the map controls are user-defined.

The following are the properties of the scale bar:

- *Break Before Zero* – Default is "False". If set to "True", the center of the scale bar will be "0" and the bar will extend out equal lengths on each side of the "0".
- *Color* – Contains a drop-down list of colors. Selecting a color will change the color of the scale bar object.
- *Font* – Displays the current font style and size for text in the scale bar object. Clicking on the  button in this field brings up a *Font* dialog where the font type, style, size, script, and any effects can be selected.
- *Map* – This field contains a drop-down list of all map objects in the Layout Editor. Selecting a map object assigns the scale bar to that map. When assigned, the scale bar will adjust to fit the scale of the map.
- *Number of Breaks* – Indicates how many interval marks will be displayed on the scale bar. Requires a minimum value of "1".
- *Text Hint* – Rasterization options for how the text will be rendered. Options include:

"System Default", "Single Bit Per Pixel Grid Fit", "Single Bit Per Pixel", "Anti-Alias Grid Fit", "Anti-Alias", and "Clear Type Grid Fit".

- *Unit* – A drop-down menu where the scale bar measurement units can be selected. Units options include: "Kilometers", "Meters", "Centimeters", "Millimeters", "Miles,", "Yards", "Feet", and "Inches".
- *Unit text* – Indicates how the units are referred to on the scale bar. Currently, this is not updated when the *Units* are changed.

The scale bar doesn't support geographic degrees. Of the dip is not equal to 0° or 90°, the scale bar doesn't show any scales.

Text

The **Insert Text**  tool inserts text in the selected location.

The following are the properties of the inserted text:

- *Color* – Contains a drop-down list of colors. Selecting a color will change the color of the text.
- *Continent Alignment* – Determines the horizontal and vertical alignment of the text inside of the text object. The default is to align the text to the upper left side of the text object.
- *Font* – Displays the current font style and size for the text. Clicking on the  button in this field brings up a *Font* dialog where the font type, style, size, script, and any effects can be selected.
- *Text* – Field where the text displayed in the text object can be edited.
- *Text Hint* – Rasterization options for how the text will be rendered. Options include: "System Default", "Single Bit Per Pixel Grid Fit", "Single Bit Per Pixel", "Anti-Alias Grid Fit", "Anti-Alias", and "Clear Type Grid Fit".

Rectangle

The **Insert Rectangle**  tool creates a rectangle in the location specified. Rectangles

created in the *Layout Editor* use general properties only and do not have specific properties.

Image

The **Insert Bitmap**  tool brings up a dialog allowing a bitmap image to be imported into the layout. This is often used for images such as a logo file.

The following are the properties of the inserted bitmap:

- *Brightness* – Increases how light the image appears. Value can be from 0–255 with the default value being "0" (no additional lightening).
- *Contrast* – Increases the difference in color in the image. Value can be from 0–255 with the default value being "0" (no additional contrast).
- *File Name* – Displays the pathname and file name of the imported image.
- *Preserve Aspect Ratio* – A drop-down menu with the options "True" or "False".
Selecting "True" will keep the image constrained to the dimensions of the imported image. Selecting "False" will change the image dimensions to fit the image object box.

Related Topics

- [GMS File Menu](#)
- [SMS File Menu](#)

3.2. The Edit Menu

Edit Menu

The *Edit* menu is one of the standard menus and is available in all of the modules. The commands in the *Edit* menu are used to select objects, delete objects, and set basic object and material attributes. The *Edit* menu contains the following commands:

Delete

Deletes the object currently selected in the Graphics Window.

Select All

Selects all items associated with the current selection tool.

Unselect All

Unselects all items associated with the current selection tool.

Invert Selection

Selects the items that were not initially selected and are associated with the current selection tool.

Select With Poly

Used to enter a polygon enclosing the items to be selected (one of the selection tools must be active). This option is useful when selecting a large irregularly shaped group of objects. To enter the polygon, click on the polygon's starting point and each intermediate point defining the polygon and double-click on the ending point. All items within the polygon will be selected.

Select With Polyline

Selects the items that intersect a polyline associated with the current selection tool.

Select From List

Brings up a list of objects associated with the current selection tool. An object is selected by checking the box next to it in the list and clicking **OK**.

Locate Selections

Causes a rectangle to be drawn on screen and move to surround the location of the selected items, helping to see where they are.

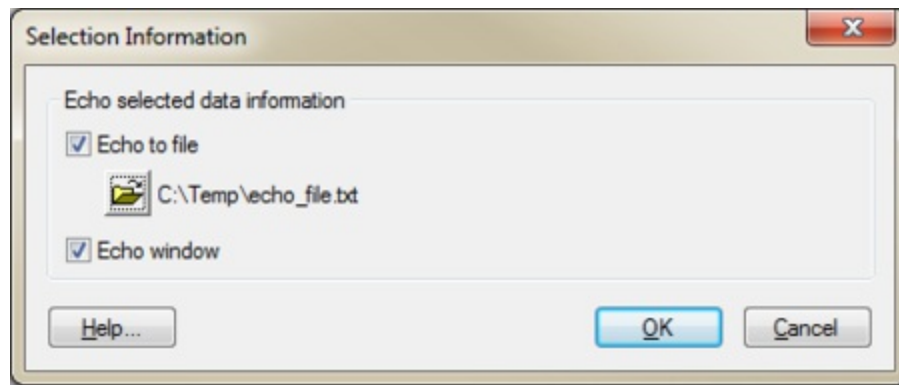

The Selection Information dialog

Selection Window

Brings up the *Selection Information* dialog allowing to turn on and off the echo of the information to a file and to a separate, dockable window. When objects are selected, various information about the objects can be displayed or saved. The values are displayed by default in the Status Bar at the bottom of the [GMS main window](#).

However, since space along the bottom of the window is limited, there is the option of displaying the information to a separate window and optionally echoing the information into a file.

Select by ID

Brings up a selection dialog where cells or objects in the selected module can be selected by the ID number.

Select By Dataset Value

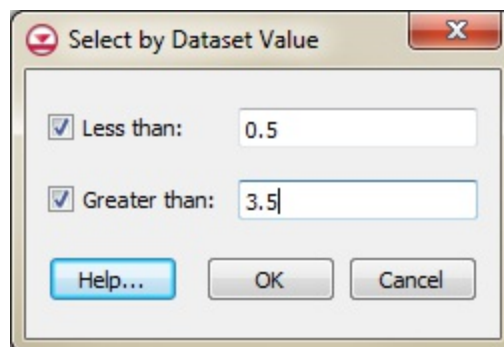

The Select By Dataset Value dialog

Opens the *Select By Dataset Value* dialog that allows selecting nodes or cells based on the dataset values when the current tool corresponds to one which selects nodes or

cells and there is a dataset associated with the nodes or cells. Select either the less than or greater than options, or both.

Dataset Calculator

Brings up the *Data Calculator* which can be used to perform mathematical operations with datasets to create new datasets.

Properties

Brings up the *Properties* dialog for the currently selected item.

Materials

Brings up the *Material Properties* dialog.

Notes

Brings up the *Notes* dialog showing all notes for all objects in the project.

Model Interfaces

Brings up the *Model Interfaces* dialog containing a list of all available models. Selecting models in this dialog determines which model menus are to be displayed in the menu bar.

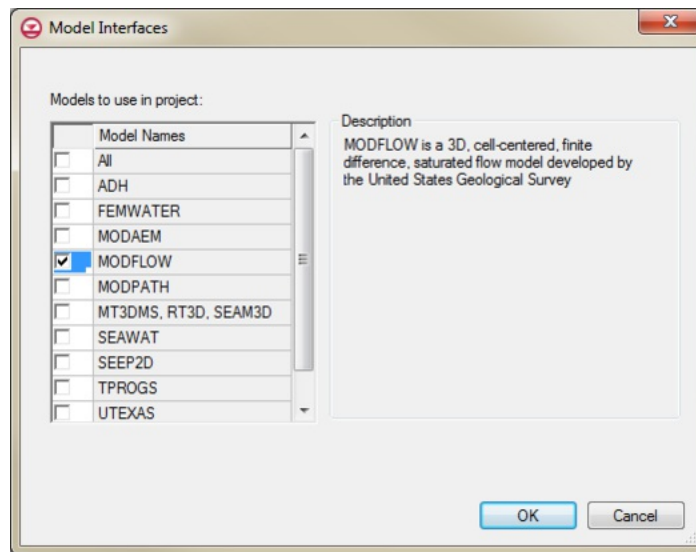

The Model Interfaces dialog

Units

Brings up the *Units* dialog which allows adjusting the units for the model.

Time

Opens the *Time Settings* dialog which allows adjusting how date and time units are

displayed.

Single Point Reprojection...

Brings up the *Reproject Single Point* dialog that allows transforming a point between coordinate systems.

Transform...

Brings up the *Transform* dialog allowing to scale, rotate and translate the entire project. Individual objects can be transformed by using the same command found in right-click context menus for the item in the Project Explorer.

Preferences

Brings up the *Preferences* dialog where it is possible to adjust the general preferences for GMS.

Screen Capture...

Copies the [Graphics Window](#) as an image to the Windows clipboard. If wanting to copy an image that is larger or smaller than the graphics window, edit the copy scale factor in the *Preferences* dialog. Brings up the *Copy To Clipboard* dialog which allows changing the bitmap scale factor. However, the clipboard has a limited amount of memory available to it; thus, GMS may not be able to scale the image up as much as it could when saving the file to disk. If a screen capture will not paste into another program, try reducing the scale factor.

Paste Text

Allows pasting tabular data directly into GMS. When this command is executed the [File Import Wizard](#) is launched.

Obsolete Menu Items

The following commands have been removed from current versions of GMS:

Coordinate System

Brings up the *Coordinate System* dialog which allows adjusting the current horizontal and vertical coordinate systems.

Coordinate Transformation

Brings up the *Coordinate Transformation Wizard* which allows performing geographic system transformations, translations, rotations, and scaling.

Related Topics

- [GMS Menu](#)

Units

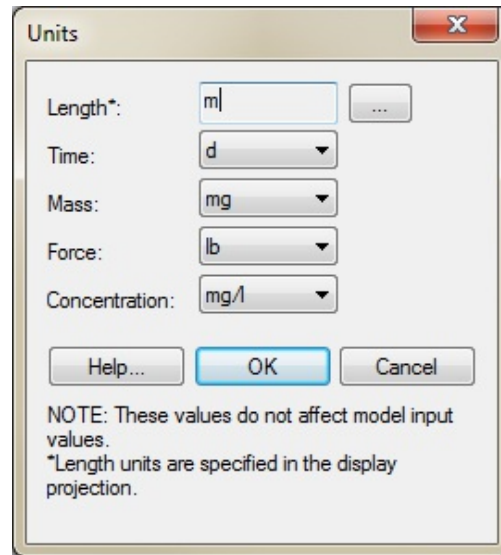

The Units dialog.

When building a ground water model, it is important to ensure that consistent units are used when entering model parameters. To simplify the management of model units, define the units for length, time, mass, force and concentration in the *Units* dialog. A units label is placed next to each of the input fields in all the model dialogs in GMS where the units are known. For example, the units for hydraulic conductivity are length / time. If the length units are defined as "m" (meters) and the time units are defined as "d" (days) in the *Units* dialog, then the units string next to the hydraulic conductivity input field would be "m/d".

Length units are specified in the [Display Projection](#) dialog which is accessed by clicking on the  button to the right.

Concentration units can be defined separately, and potentially inconsistently with, mass and length units. This allows for more flexibility but can also lead to confusion so use care when selecting concentration units.

The *Units* dialog is accessed by using the **Units...** command in the *Edit* menu.

Unit Conversion

Generally speaking, GMS does not convert quantities from one system of units to another. GMS only displays the chosen units to help in checking consistency. However, in a few places, GMS will use the currently defined units in its calculations. These include:

- in the *FEMWATER Fluid Properties* dialog,
- in the *Curve Generator* dialog,
- when calculating the stream stage constant when saving MODFLOW, and
- in the **Measure** tool.

See also

- [Edit Menu](#)

Preferences

The *Edit | Preferences* command brings up the *Preferences* dialog.

General

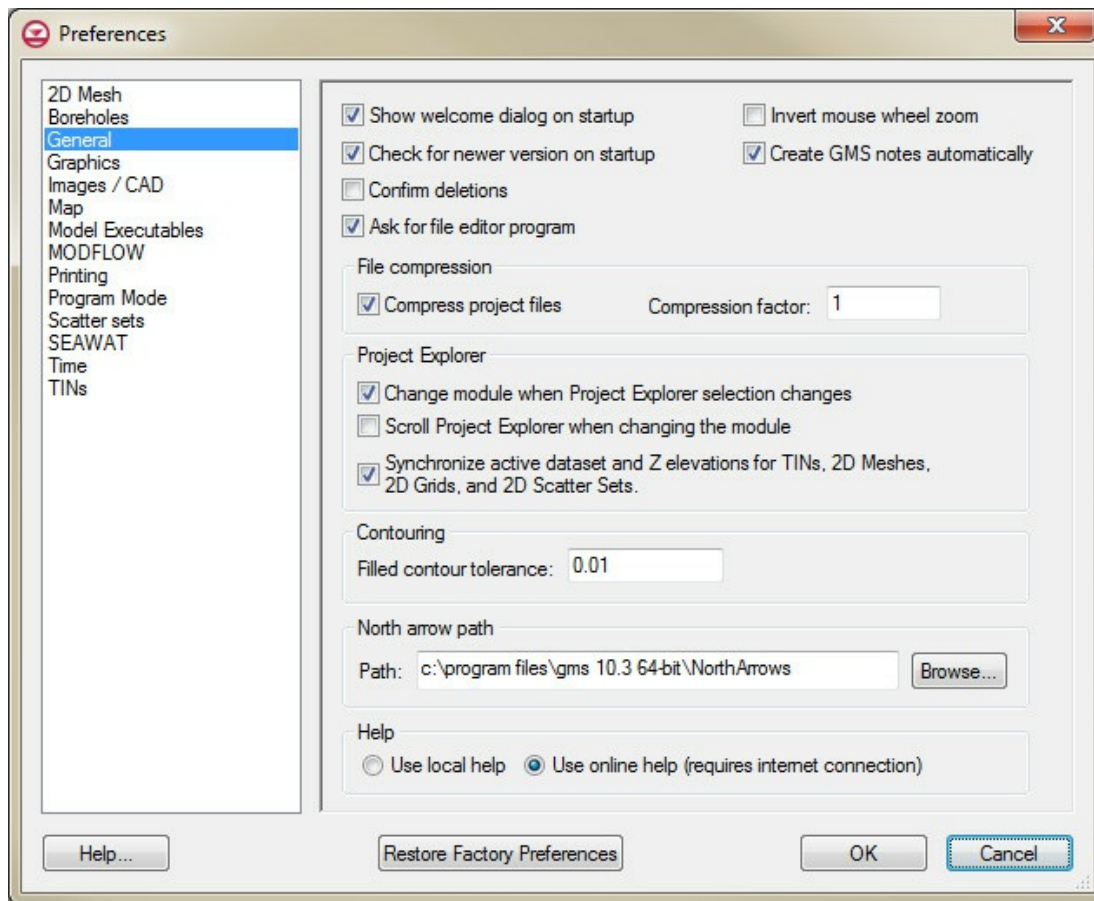

The Preferences dialog showing the Graphics tab

The *General* tab has all the of the general options in GMS.

- *Show welcome dialog on startup* – When turned off, the welcome dialog will not appear when starting GMS.
- *Check for newer version on startup* – When turned on, GMS will check aquaveo.com downloads page for the most recent release of GMS. If a new release is found, a prompt will appear asking if wanting to download the newer release.

- *Confirm Deletions* – Choose whether or not to be prompted to confirm the deletion whenever a set of selected objects is about to be deleted. This is meant to ensure that objects are not deleted accidentally.
- *Ask for file editor program*
- *Invert mouse wheel zoom* – Changes direction of the zoom with the mouse wheel
- *Create GMS notes automatically* – When on, certain actions will cause **notes** to automatically generated.

Sections:

- *File compression* – Use compression when saving XMDF files. The compression factor can be specified.
- *Project Explorer* – Allows modifying preferences related to the Project Explorer.
 - *Change Module when tree selection changes* – Changes the current module when a item is selected in the Project Explorer. This option is on by default.
 - *Scroll Project Explorer when changing module* – Ensures the visibility of the tree item objects in a module when the module is changed.
 - *Synchronize active dataset and Z elevations for TINs, 2D Meshes, 2D Grids, and 2D Scatter Sets*
- *Contouring* – Allows entering a filled contour tolerance.
- *North arrow path* – Specify the path to the folder containing the North Arrows.
- *Help* – Options to use local help or online help. Online help is the default option.

Buttons at the bottom:

- **Help...** – Specify to use either a local help file or the online help file when clicking on the **Help** button in any dialog.
- **Restore Factory Preferences** – Reverts all settings to the factory defaults.
- **OK** – Accepts the settings as selected and entered and closes the *Preferences* dialog.
- **Cancel** – Close the *Preferences* dialog without saving any changes to the settings.

Model Executables

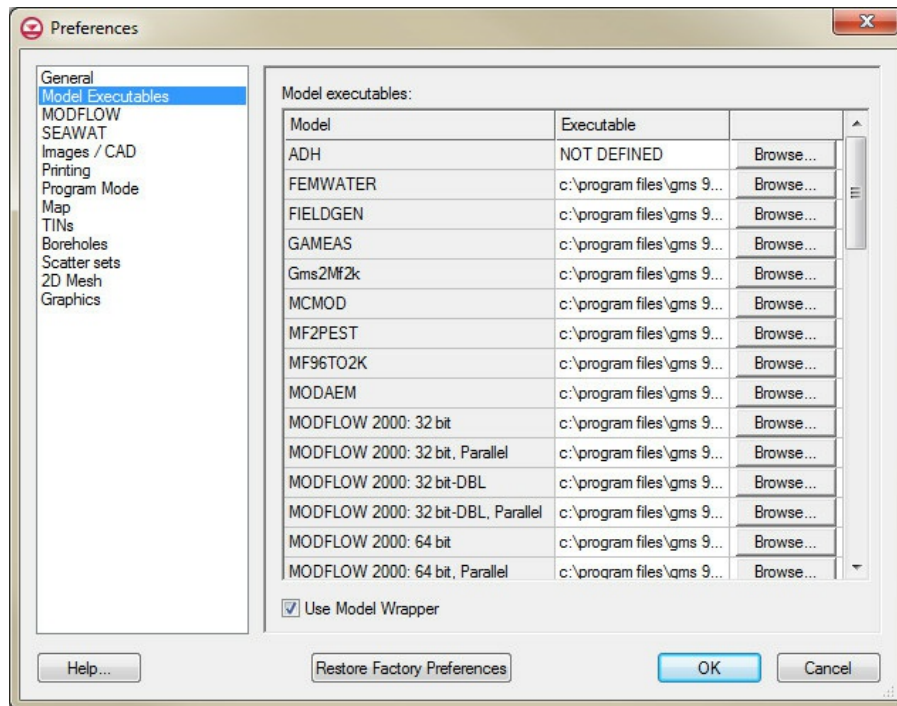

The Preferences dialog showing the Models options

The *Models* page allows specifying the location of model executables, as well as the option to use the Model Wrapper.

- *Model Wrapper*

- GMS is a pre- and post-processor for . Most of these numerical models are run externally in the DOS environment. The default option is to use the Model Wrapper. The Model Wrapper "wraps" itself around the same DOS executables and gives more model feedback including graphs and tables. The Model Wrapper includes a toggle box in the bottom left that, when checked and after exiting the Model Wrapper, GMS will automatically read in the results of the solution. This toggle will only be checked by default if the model converged. The option to use the Model Wrapper or the old DOS view is included in the dialog. Certain models, including and inverse modeling, can only be run using the Model Wrapper.

Parallel versions of MODFLOW-2000, MODFLOW-2005, and SEAWAT are shipped with GMS to run simulations. Beginning with version 8, GMS ships parallel versions where the SAMG solver has been parallelized. Even when this option is on, when running Parallel PEST with MODFLOW the serial (non-parallel) version of MODFLOW will be used since the Parallel PEST will use all of the available cores on the computer with the serial version. Also see [MODFLOW preferences](#) for an option to turn on or off the parallel version.

MODFLOW

The *MODFLOW* page has options related to the MODFLOW interface in GMS.

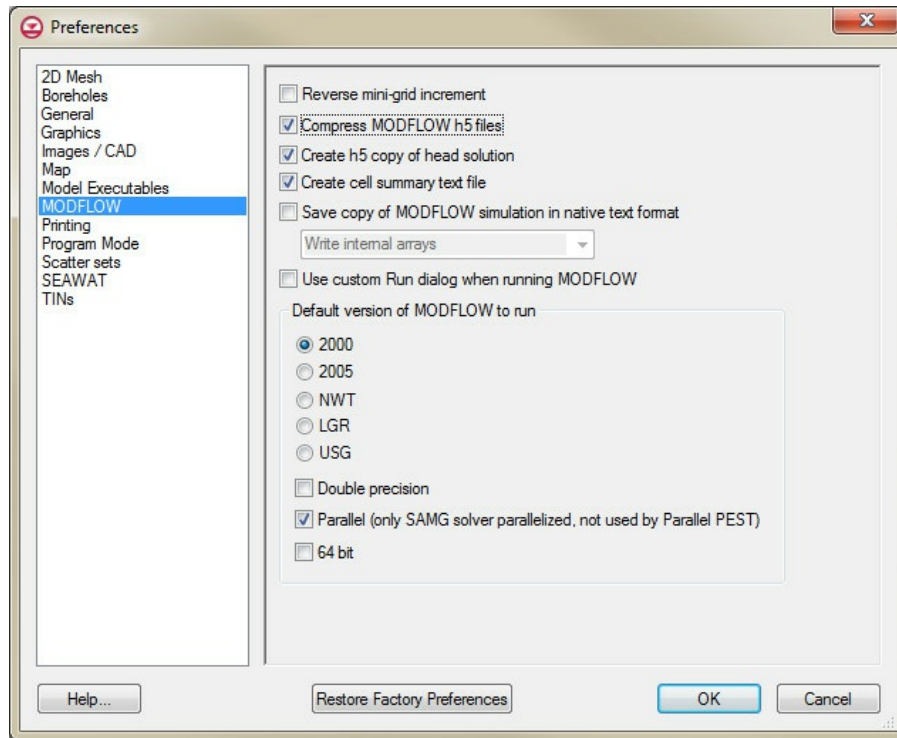

The Preferences dialog showing the MODFLOW tab.

- ***Reverse mini-grid increment***
 - The default functionality of the arrows next to the edit field on the mini-grid tool bar is for the up arrow to increase the layer number and for the down arrow to decrease the layer number. This option changes direction of the arrows so that down will increase the layer number and up will decrease the layer number.
- ***Compress MODFLOW H5 files***
 - This option will force the H5 files saved with MODFLOW to be compressed. Generally this option should be turned on.
- ***Create h5 copy of head solution***
 - Turning on this option can speed up reading the MODFLOW head solution especially when there are a large number of stress periods. When this option is on, GMS writes an HDF5 copy of the MODFLOW head solution upon reading it the first time. The following times GMS reads the head solution, it doesn't take as much time.
- ***Create cell summary text file***

- A text file is created when reading the MODFLOW head file that provides a summary of the the number of active, inactive, dry, and flooded cells at each output time of the simulation. The text file is added to the MODFLOW solution and can be opened from the Project Explorer.
- *Save copy of MODFLOW simulation in native text format*
 - This option will create an additional MODFLOW directory when the GMS project is saved that will contain native MODFLOW text files of the MODFLOW simulation. The new directory will be named as follows `_MODFLOW_text`. There are three additional preferences with this option: all arrays be written internally in the MODFLOW files (default option), all arrays are external from the MODFLOW files, or all arrays are external and are placed in a directory named "arrays".
 - External arrays are placed in their own text files and are named as follows . For example the ibound array for layer 1 would have the following name `myProject_array_BAS_IBOUND_1.txt`. The recharge array for stress period 3 would have the following name `myProject_array_RCH_RECH_3.txt`.
- *Use custom Run dialog when running MODFLOW*
 - This option will bring up the dialog when the | menu command is selected.
- *Default version of MODFLOW to run*
 - Allows selecting the version of MODFLOW to be used as a default when GMS is started.
- *Double precision*
 - When this option is on, GMS will use the double precision version of MODFLOW to run simulations. By default this option is off and GMS uses the single precision version of MODFLOW.
- *Parallel (not used by Parallel PEST)*
 - When this option is on, GMS will use the parallel version of MODFLOW to run simulations. Beginning with version 8, GMS ships parallel versions of MODFLOW where the SAMG solver has been parallelized. Even when this option is on, Parallel PEST will use the serial (non-parallel) version of MODFLOW since the Parallel PEST will use all of the available cores on the computer.

Images / CAD

- *Bitmap Scale Factor*
 - When the copy command is selected, a bitmap image of the screen is placed on the clipboard. The scale factor can be used to increase or decrease the resolution of the bitmap. This scale factor also applies when saving the image as a bitmap.
- *CAD Symbol Size*

- o The size of the CAD symbol display can be specified.

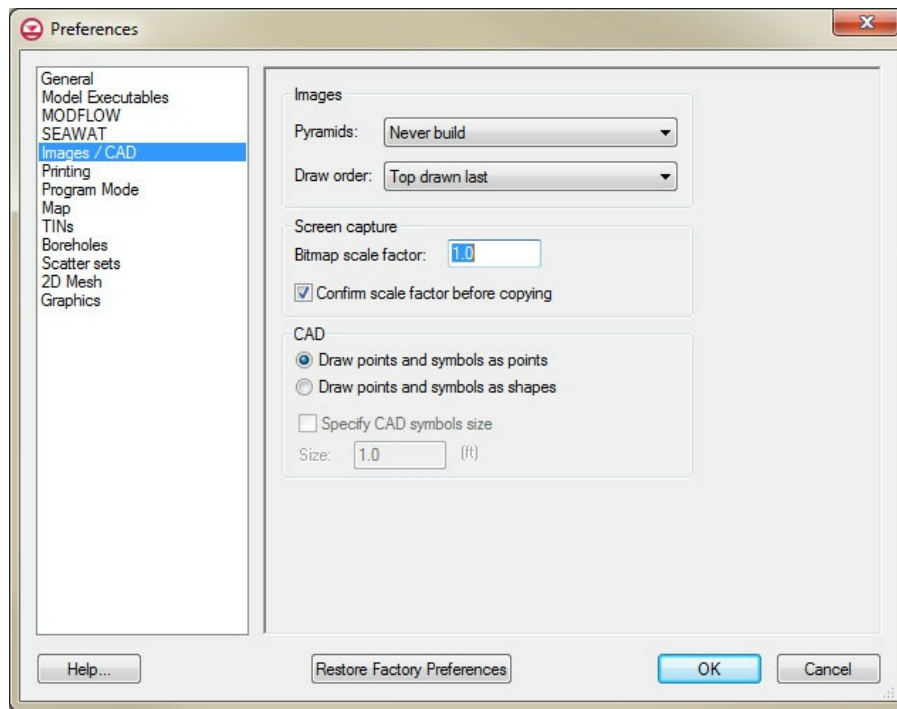

The Preferences dialog showing the Images / CAD tab

Printing

Specifies scaling points, lines, and fonts while printing.

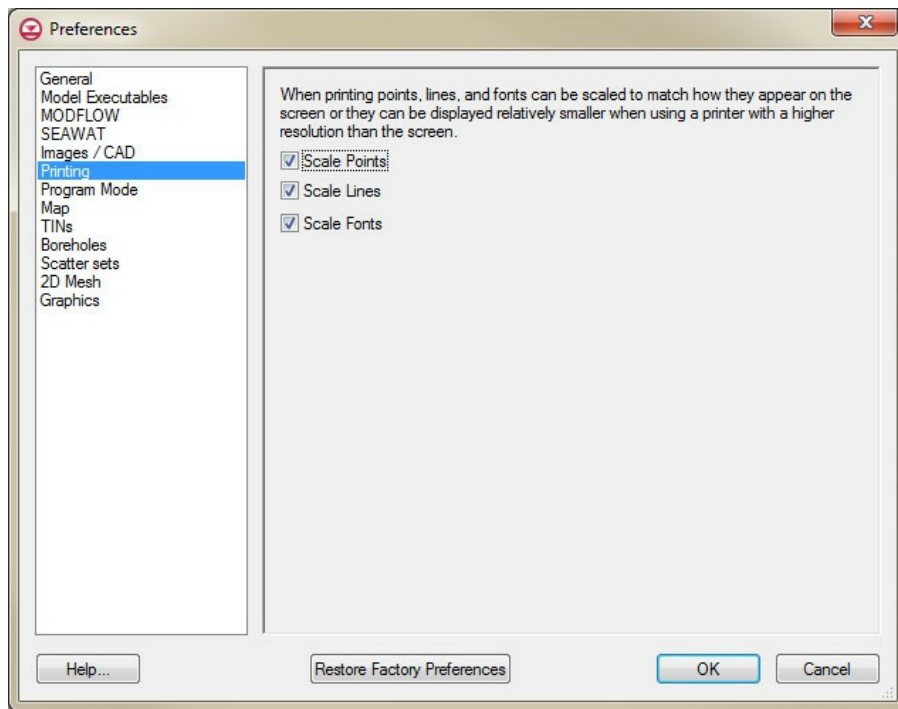

The Preferences dialog showing the Printing tab

Program Mode

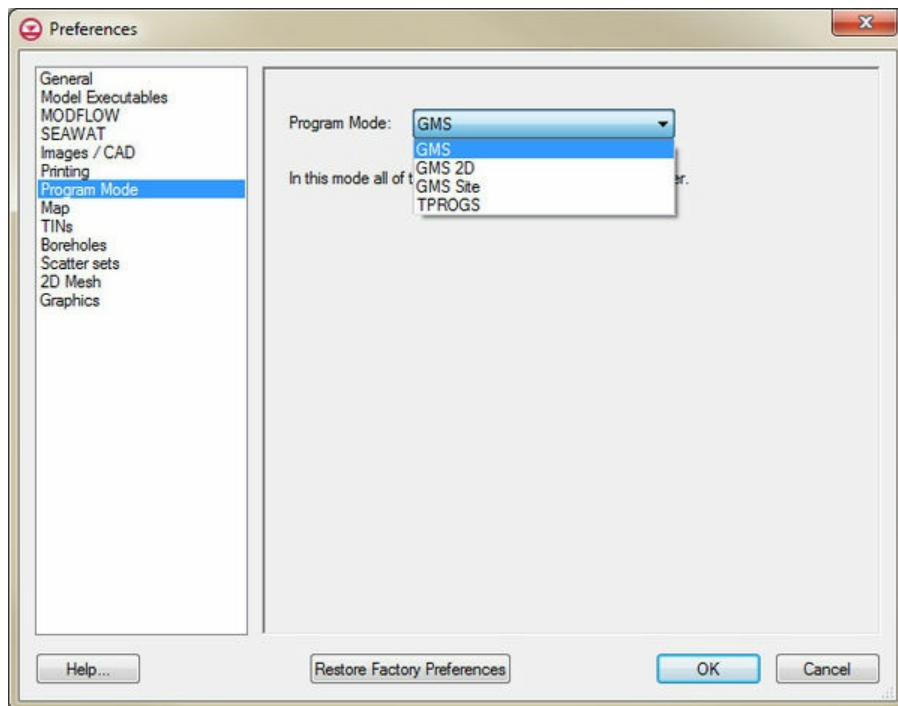

The Preferences dialog showing the Program Mode tab.

GMS has the option of changing the "mode" or "skin" that GMS is running. The purpose of the mode is to simplify the items available in the interface.

Available Modes

- GMS
 - This is the default mode.
- GMS 2D
 - GMS 2D is for only using GMS to do seepage and slope stability. In GMS 2D mode the only tools that are available are the 2D mesh and the Map. There are several changes to the GMS interface when in this mode, including:
 1. Hiding of tools and modules not in use
 2. SEEP2D model automatically initialized from conceptual model
 3. SEEP2D boundary conditions automatically mapped from conceptual model (no need to run Map → SEEP2D)
 4. Easily create all coverage types in one step
 5. Feature object types automatically assigned based on coverage attributes
 6. Allow only one conceptual model

When starting up in GMS 2D mode, a *New Project* dialog will appear. The following errors may also appear when opening some project files. These errors may state any of the following:

- Your project file contained more than one conceptual model. This version of GMS only supports one SEEP2D/UTEXAS conceptual model. The first encountered SEEP2D/UTEXAS conceptual model has been preserved and all other conceptual models have been removed from the project.
- Error. This requires the "MODFLOW" component. Your GMS license does not include this component. Contact your vendor if you would like to enable this feature.
- The project that you are reading does not have a SEEP2D/UTEXAS conceptual model. The project can not be loaded into this version of GMS.
- GMS Site

- GMS Site is for only using tools for site characterization. As such the tools available in this mode are TINs, Boreholes, Solids, 2D Scatter, and Map. These tools can be used to construct solid models of stratigraphy.

- TPROGS

- Used to perform transition probability geostatistics on borehole data.

Caveats

When GMS is running in a particular mode then only data associated with the available tools will be read into GMS. For example, if having a GMS project file that contains a 3D Grid, and running in "GMS 2D" mode then when reading in the project file a message will appear stating that GMS is not enabled to read in 3D Grid data. The only data that will read into GMS in "GMS 2D" mode is data associate with the 2D Mesh and the Map.

Map

Gives the option to automatically perform the **Map**→**SEEP2D** command.

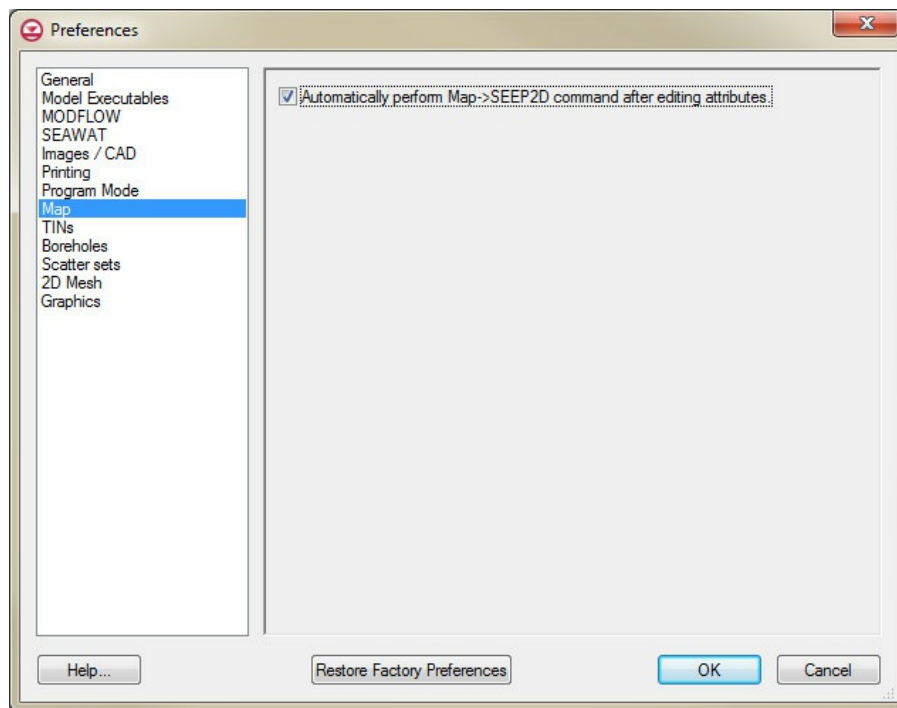

The Preferences dialog showing the Map tab.

TINs

The *TINs* tab has the following options:

- Vertex options
 - Retriangulate after deleting
 - Default z-value
 - Confirm z-value
 - Interpolate for default z on interior
 - Extrapolate for default z on exterior
 - Breakline options
 - Add supplementary points
 - Swap edges
- Minimum length ratio

For more detailed information, see [TIN Settings](#).

Boreholes

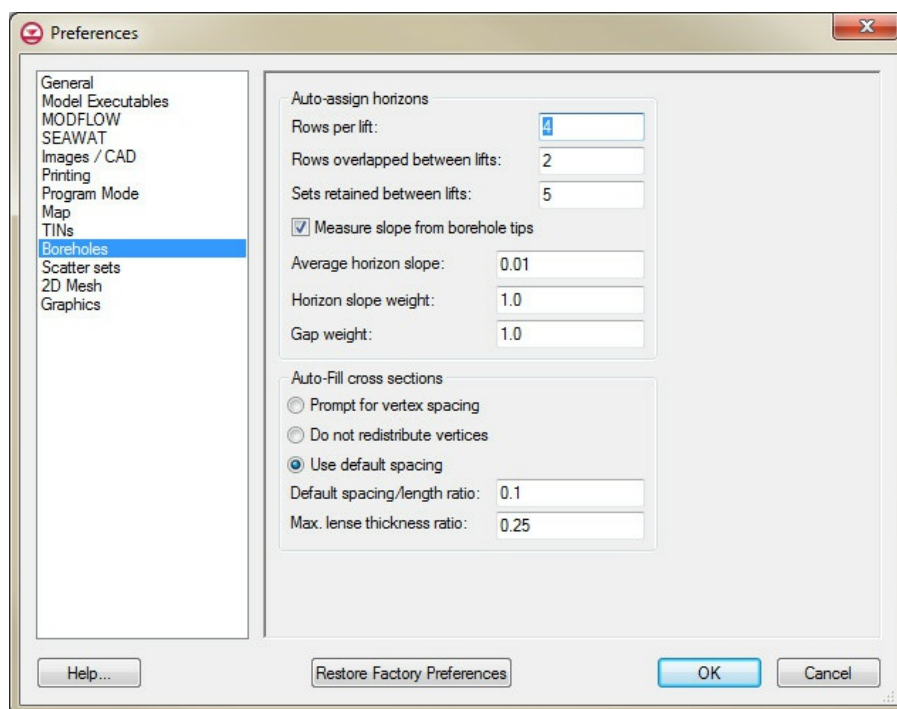

The Prefrences dialog showing the Borehole tab.

- Auto-assign horizons

- Rows per lift
- Row overlapped between lifts
- Sets retained between lifts
- Measure slope from borehole tips
 - Average horizon slope
 - Horizon slope weight
 - Gap weight
- Auto-Fill cross sections
 - Prompt for vertex spacing
 - Do not redistribute vertices
 - Use default spacing
 - Default spacing/length ratio
 - Max. lense thickness ratio

Scatter sets

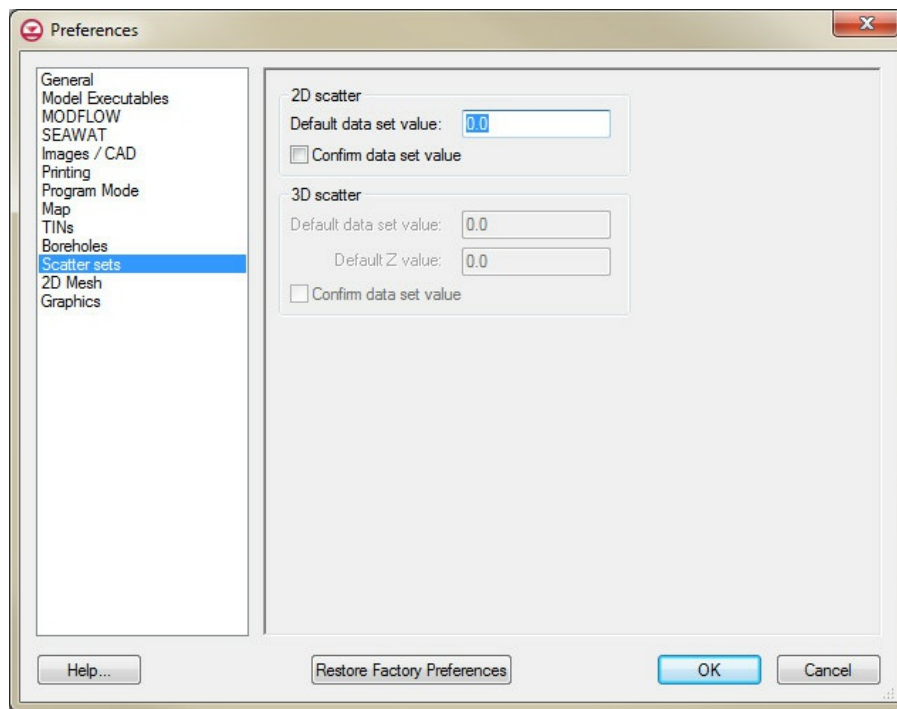

The Preferences dialog showing the Scatter Sets tab.

- 2D scatter

- Default dataset value
- Confirm dataset value
- 3D scatter
 - Default dataset value
 - Default Z value
 - Confirm dataset value

2D Mesh

The *2D Mesh* tab has the following options:

- Interpolate for default z on interior
 - Default z (ft)
- Assign default z-value
- Prompt for z-value
- Insert nodes into triangulated mesh
- Check for coincident nodes
- Retriangulate voids when deleting
 - Thin triangle aspect ratio

For more information, see [2D Mesh Settings](#).

Graphics

- *Multisampling level* – Bigger numbers result in smoother, antialiased graphics. 0 = no multisampling, 16 = maximum multisampling. If this option is changed, GMS must be restarted before the change will take effect.
- *Use smooth fonts* – anti-alias fonts

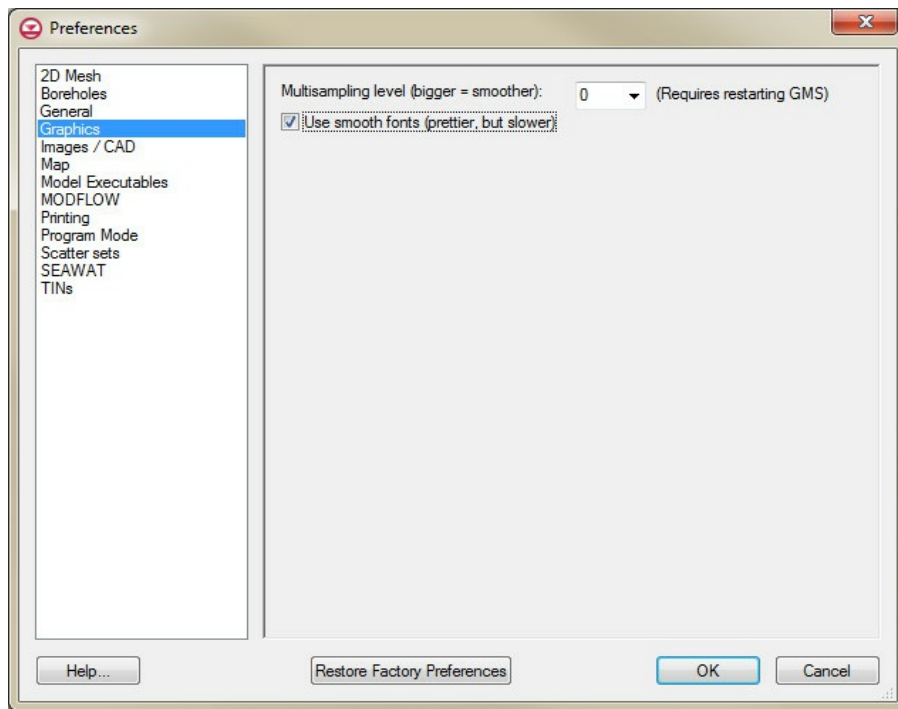

The Preferences dialog showing the Graphics tab

Obsolete Options

- Ask which library to use if system does not support all functionality
- Autoselect the software library if system does support all functionality
- Always use system library like a dedicated GPU (may not support all features)
- Always use software library on the CPU (may be slower)

Related Topics

- [Edit Menu](#)

Materials

Many of the objects in GMS (ex., elements, solids, borehole regions) have an associated material. Materials typically represent a type of soil or rock. A global list of materials is maintained and can be edited using the **Materials** command in the *Edit* menu.

Materials Dialog

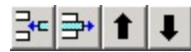

Insert, delete, move up, move down buttons

The Materials are listed in a spreadsheet. Materials have an ID, name, color and pattern. New materials can be created by typing in the last row, or by copying and pasting from a spreadsheet, or by selecting the **Insert** button. The dialog also has tabs showing model specific properties for each [numerical model](#) in use.

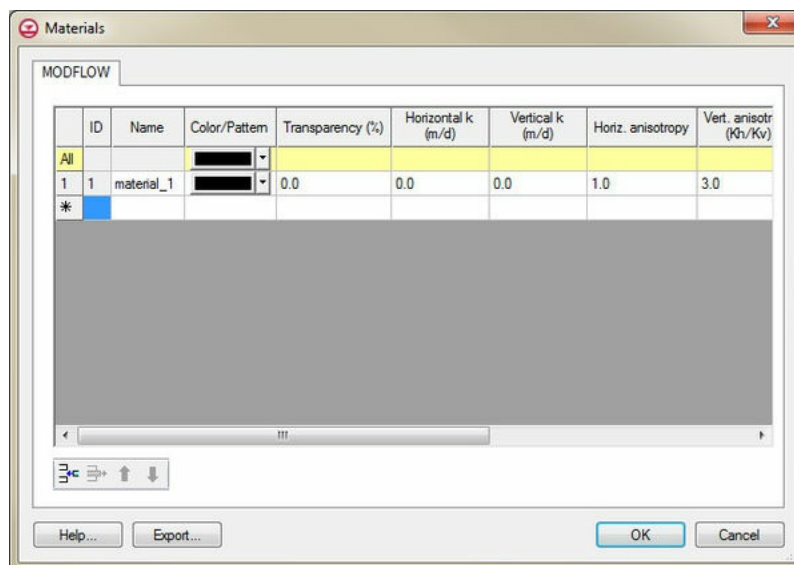

An example of the Materials dialog.

Materials Legend

A legend showing all the materials can be displayed in the [Graphics Window](#). The legend can be turned on and off in the [Display Options](#) dialog.

Materials File

The material names, colors, patterns, and transparencies can be exported by selecting the **Export** button. This will save out a "material" file with a *.mat extension. This file can be imported into GMS using the *File* | **Open** command.

Related Topics

- [Edit Menu](#)

Material Set

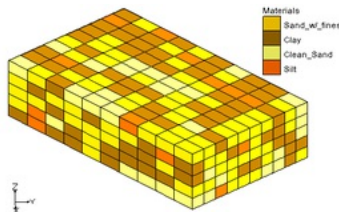

3D grid showing materials from a material set.

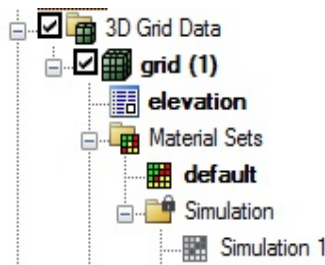

A material set in the Project Explorer.

A material set is similar to a [dataset](#) but represents [material](#) values instead of data values. Material sets can exist with [3D grids](#) and [meshes](#) and can be created manually or by running a [T-PROGS](#) simulation. To create a material set manually, right-click on the 3D grid or mesh in the [Project Explorer](#) and select the *New Material Set* command. Doing so will create a material set from the current cell or element materials. All Material sets are grouped under a Material Sets  folder in the Project Explorer. Although grid cells and mesh elements (as well as other objects) have materials associated with them from the start and these material assignments can be changed on a cell-by-cell (or element-by-element) basis, a material set is not available until specifically created. Clicking on a material set causes the set to be applied to the grid cells (or mesh elements) and the material assignments of the cells updated.

Properties

As with datasets, a material set has properties that can be viewed. Right-clicking on the material set in the Project Explorer and selecting the **Properties** command brings up the *Material Set Info* dialog. This dialog lists the materials in the material set, their frequency and percentage. A histogram is also drawn showing the frequency of the different materials in the set.

Viewing / Editing

Clicking the **Edit Materials** button in the *Material Set Info* dialog brings up a table showing the materials in the material set, similar to viewing values in a dataset. The materials can be edited and saved.

Inactive Values

As with datasets, material sets can include inactive values (starting at GMS version 8.0). Inactive materials are rendered using a material with ID -9999999.

Material Set Solutions

TPROGS can generate multiple material sets as part of its solution. These are stored in a material set solution folder which is locked against editing. Material set solutions can be used to run a [stochastic](#) simulation in MODFLOW.

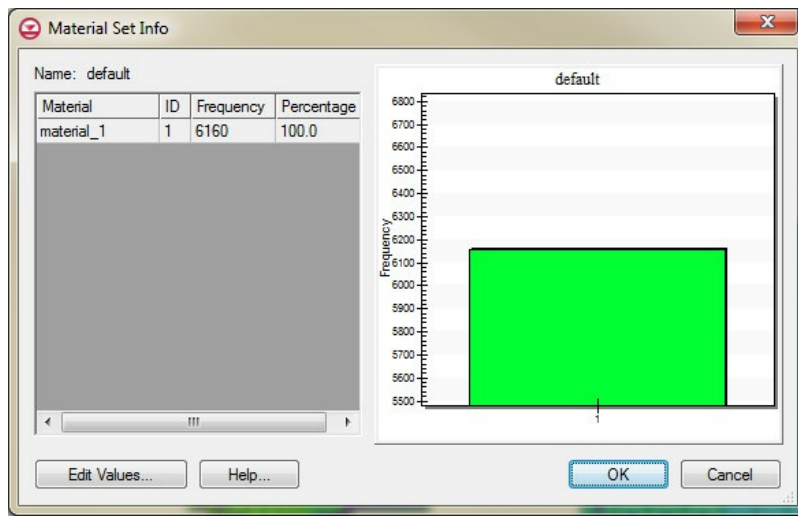

An example of the Material Set Info dialog.

Time Settings

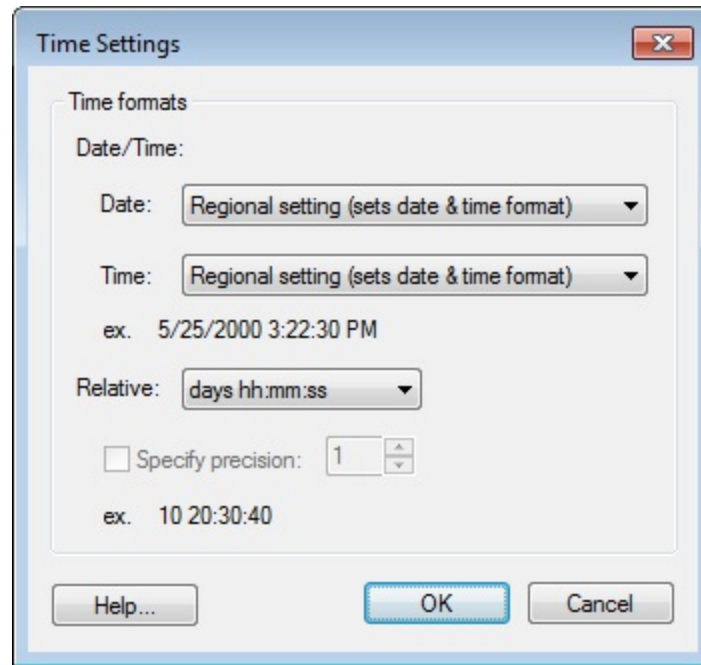

Time Settings dialog

The *Time Settings* dialog is used to control how dates and times are displayed in GMS. The dialog is reached through the *Edit* | **Time** menu command. Time data can be encountered in various places in GMS such as:

- Transient datasets
- MODFLOW stress period input
- XY Series input

The *Time Settings* dialog can be used to format dates and times using the computer's regional settings, or using a number of other formats.

Date/Time vs. Relative

Time data that has an associated reference time—a real calendar date and time—can be

displayed as dates/times. Time data that lacks a reference time can only be displayed as relative times which are simple scalar values (0.0, 2.0, 3.0 etc).

3.2.1. Coordinate Systems

Projections

Projection refers to a map projection like UTM. In XMS software, a projections are associated with the project and individual data objects.

Starting with SMS 11.1 and GMS 9.1, the XMS software works on the concept of a "Display Projection". This is the projection being worked in. Each geometric object loaded into the XMS package, such as a Scatterset, DEM, grid or mesh, also has an associated projection. These two projections may not be the same. If the two projections are compatible (i.e. it is a viable option to convert from one projection to the other), the XMS package will convert the data from the object projection to the display projection, just for display purposes. This is referred to as "Project on the fly". The data itself maintains the values associated with the object projection so when the XMS package saves a project, the data files are not modified.

Alternatively, data can be reprojected from one projection to another, actually changing the data values that will be saved as part of a project. This is done by right-clicking on the geometric object in the project explorer (data tree) and selecting the **Reproject...** command. The SMS package includes a feature to reproject all data from whatever projection the data is currently in to a single projection using the **Reproject All...** command in the *Display* menu.

XMS software utilizes the [Global Mapper \(TM\)](#) library which supports hundreds of standard projections.

Previous XMS software versions referred to projections as "coordinate systems" and reprojection as "coordinate conversion".

Display Projection

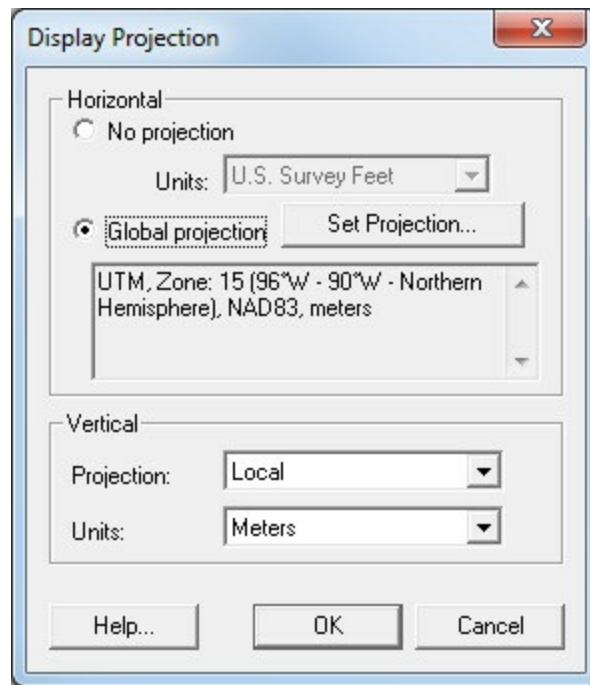

Example of the Display Projection dialog.

The display projection, or the projection currently associated with the project, can be specified via the *Display* | **Projection** menu command. This setting controls how the XMS application displays (or interprets) data. Data defining objects with a specified projection are converted to the display projection (if it is different from the object projection) for display purposes only. This is referred to as "projection on the fly". The data saved to files as part of a project, or exported for a simulation are exported in the object projection. Display projection only affects the display.

Objects without a specified projection are assumed by the XMS application to be referenced to the display projection.

The display projection is saved as part of a project file. Specify a display projection as part of the system settings for new sessions/projects.

When a data object is read into an XMS application, for which no data has yet been loaded and no projection has been specified, and the data object has its own projection, the display projection is reset to the object projection. This allows defining a working projection simply by loading data that uses that projection (and has a projection definition such as a *.prj file to define it.)

No Projection (Previously Local Projection)

Many numerical models work in local or model space, and don't care how that system relates back to global coordinate systems (UTM, State Plane etc.). XMS software allows for this using a Display projection set to local or no projection option. This is standard practice when building a numerical model of a flume test. The units of the model are also specified as part of the projection. If the display projection is in this mode, no global projections are allowed on individual objects.

(Note: when the display projection is set to *No Projection* or *Local Projection*, the data may still be referenced to a projection. The display projection can be changed to reflect that projection if desired.)

Global Projection

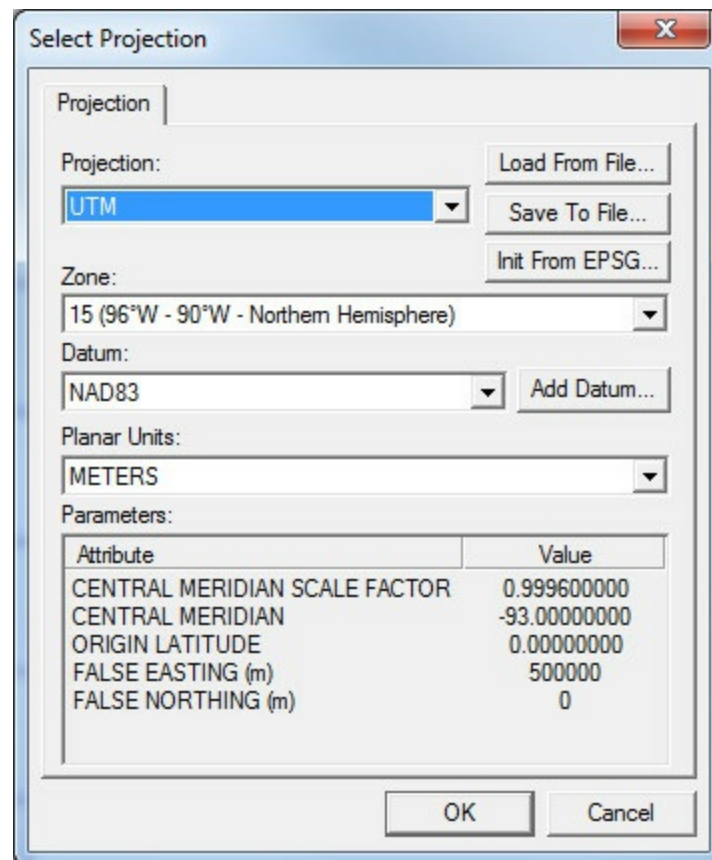

The Select Projection dialog.

Data referenced to a global projection can be easily correlated and used with other applications that utilize projections including GIS and CAD. When the display projection is

specified as a global projection, the XMS application can export georeferenced images, shapefiles, and KMZ files that may be directly imported to other applications.

Selecting the *Global Projection* option will automatically bring up the *Select Projection* dialog where a global projection can be chosen. If the *Select Projection* dialog does not automatically appear, or desiring to change the current global projection, then the **Select Projection** button in the projection dialog can be used to access the dialog.

Object Projection

Each geometric object loaded into a session can have an associated projection. When an object is loaded from a file, the XMS application looks for a projection either in the object data file or in an associated *.prj file. If no projection is found, the object is left with no projection or floating. In this case, the object is assumed to be related to the display projection, regardless of what that projection is. The object projection can be specified by right-clicking on the object in the project explorer and selecting the **Projection...** command. The default projection displayed in the dialog that appears is the object's projection if it has one, and no projection otherwise. In the case of no projection, the display projection is filled in as the default global projection should that option be selected.

Reproject

Reprojecting means to convert data from one coordinate system to another. For example, a 2D mesh representing the ground surface may have XYZ coordinates in a UTM system and they need to be converted to a State Plane system to be consistent with other data.

Reprojecting results in the XYZ coordinates of the data changing, although conceptually the data is in the same place with respect to the Earth, just in a different projection or coordinate system.

There are four basic reprojection tasks:

- Reproject on the fly, which just displays all data in a specified projection without changing the base values

- Reprojecting the entire project from one system to another
- Reprojecting one geometric object (i.e. mesh or grid) from one coordinate system to another
- Single point reprojection, which allows entering the XYZ coordinates for a point in one projection and see what the new coordinates would be if the point was reprojected to a different projection.

Reproject on the Fly

When data from multiple projections are loaded into an XMS application, without a defined projection, they do not overlay and the display shows data clusters at two distinct locations. With project on the fly, if the data object has a defined projection (such as a *.prj file), this data would be reprojected on the fly to the display projection.

If data does not line up due to incorrect or incomplete projection specification, specify different object projections to attempt to align the data correctly. Object projection is specified by right-clicking on the object in the project explorer.

Reproject everything

Reprojecting everything can be done by selecting the *Display* | **Reproject All...** menu command. This will convert all the data loaded into the XMS application from the object projection(s) to a specified projection. This operation brings up a dialog which allows specifying the desired projection. The default value is the display projection currently specified for the project.

Reproject object

This command is done on a specific geometric object (grid, mesh, scatter set, ...) by right-clicking on the entity in the Project Explorer and selecting **Reproject....** If the object does not have a specified projection, this command is not available. It can be accessed by selecting the **Projection...** command for the object in the same right-click menu and defining a projection for the object.

When the object has a projection, this command reprojects from one projection to another.

The command brings up a dialog with a "from" projection specified on the left and a "to" projection specified on the right. The "from" projection is defaulted to the object projection. The "to" projection is defaulted to the display projection.

Single Point Reprojection

Single Point Reprojection command is found in the *Display* menu and allows entering the XYZ coordinates for a point in one projection and see what the new coordinates would be if the point was reprojected to a different projection. It also allows creating a feature point at the new location.

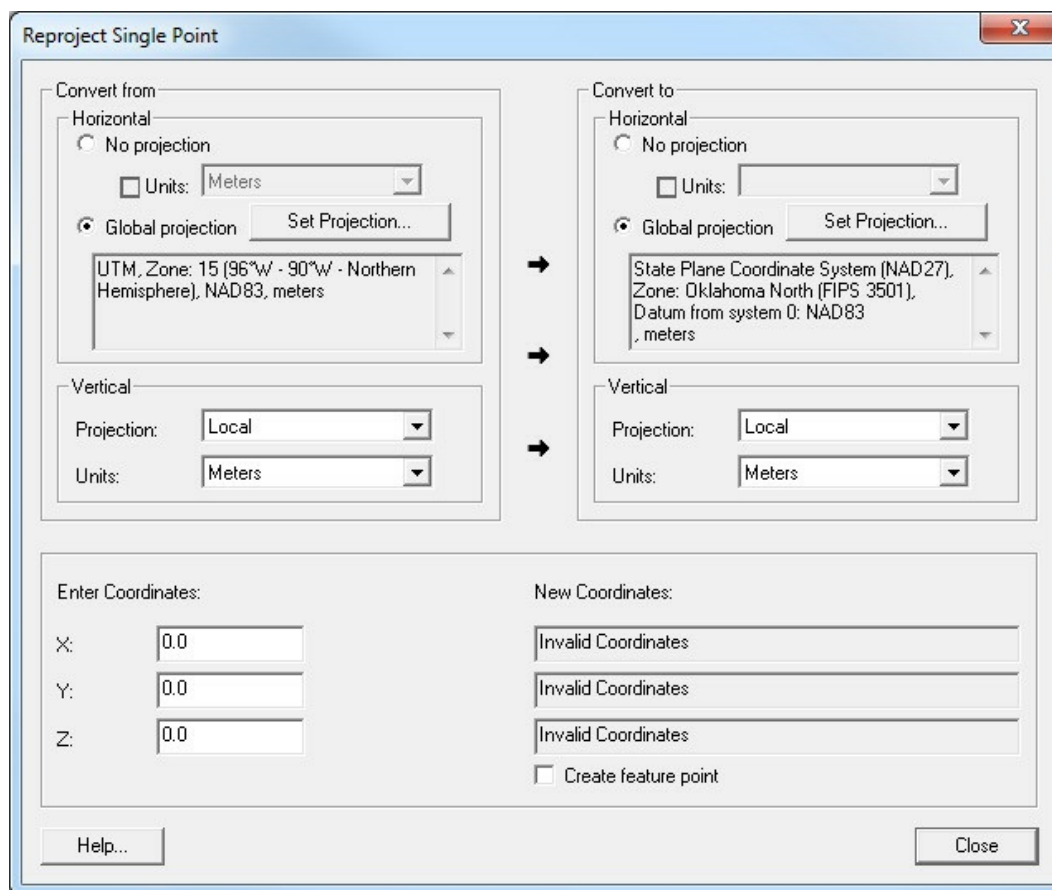

Example of the Reproject Single Point dialog.

Restrictions

Some reprojections are not allowed, such as reprojecting between a NAD and non-NAD system. A warning is issued when the reprojection is not allowed.

Supported Projections

XMS software utilizes the [Global Mapper \(TM\)](#) library which supports hundreds of standard projections.

Related Topics

- [Projection Dialogs](#)

Projection Dialogs

There are two main projection dialogs used in SMS, GMS, and WMS: The *Display Projection* dialog, and the *Object Projection* dialog. From each of these, the *Select Projection* dialog can be accessed. More detailed information about each projection and the information in these dialogs can be found in the [Projections](#) article.

Display Projection Dialog

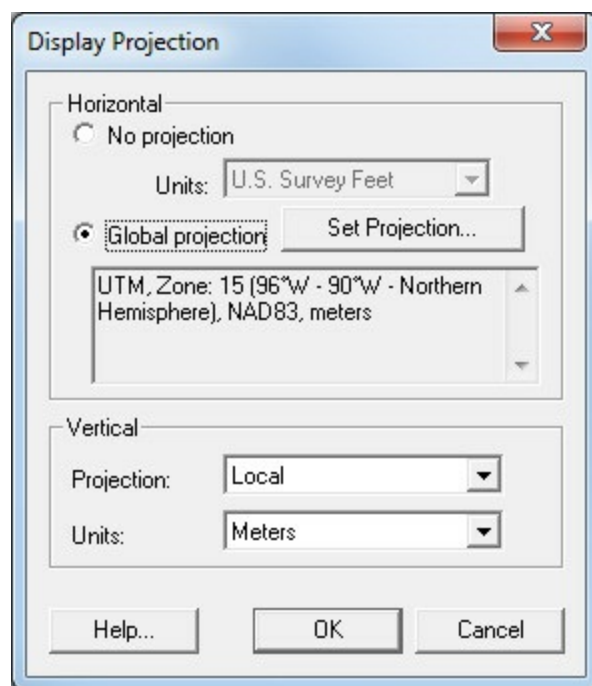

Example of the Display Projection dialog.

The *Display Projection* dialog contains settings which are applied to the project as a whole.

Horizontal section

The *Horizontal* section of the dialog has two options available via radio buttons:

- *No projection* – This option doesn't set a projection, and only allows adjusting the horizontal *Units* used in the project. The available units include:

- "U. S. Survey Feet". Equal to $\frac{1200}{3937}$ meters, approximately 0.3048006096 meters.
- "International Feet". Equal to 0.3048 meters.
- "Meters". Equal to the distance traveled by light in vacuum within $\frac{1}{299792458}$ of a second.
- "Inches". Equal to $\frac{1}{39.37}$ of a meter.
- "Centimeters". Equal to $\frac{1}{100}$ of a meter.
- *Global projection* – Clicking on the **Set Projection** button allows more specific projections to be set. These are listed below in the [Select Projection Dialog](#) section.

Vertical section

The *Vertical* section has two drop-down boxes:

- *Projection*, giving the following options:
- "Local"
 - "NGVD 29 (US)"
 - "NAVD 88 (US)"
 - "U. S. Survey Feet"
 - "International Feet"
 - "Meters"
 - "Inches"
 - "Centimeters"

Object Projection Dialog

The *Object Projection* dialog is the same as the *Display Projection* dialog, but only applies to one specific object (e.g., a coverage or a mesh). It can be accessed by selecting the

object in the Project Explorer, then right-clicking on it and selecting **Projection...** from the menu.

Select Projection Dialog

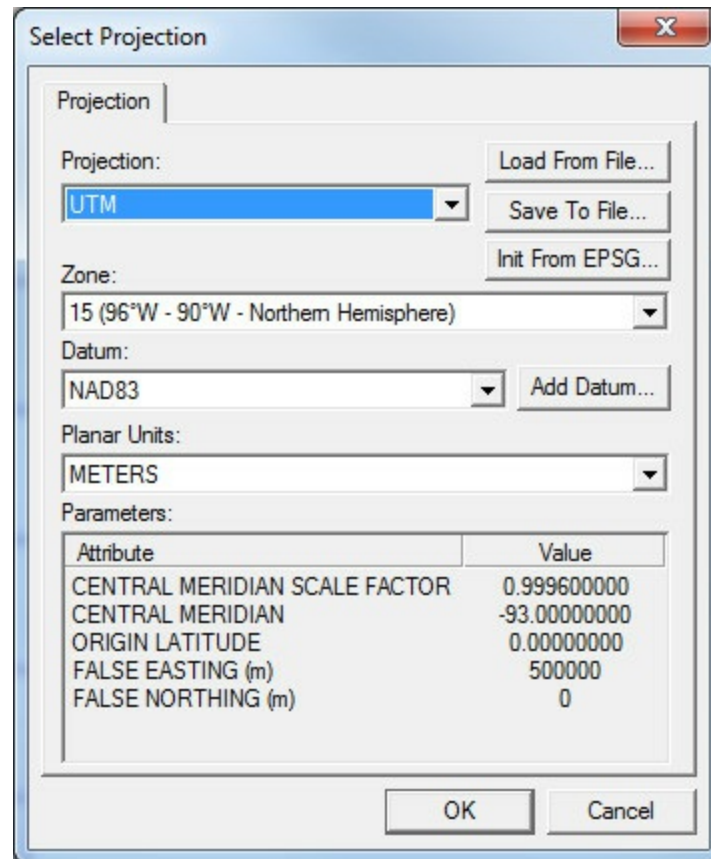

The Select Projection dialog.

The *Select Projection* dialog is accessed through the **Set Projection...** button in either the *Display Projection* dialog or the *Object Projection* dialog. It allows setting global projections for the project or for a specific object. It contains a single *Projection* tab with several options and sections.

All lists of drop-down selections are given in the order in which they appear in the drop-down.

Projection and Zone

There are many options available from the *Projection* drop-down:

List of Projections

The *Projection* drop-down contains the following options. If there is *Zone* information for a particular projection, the zones will be listed directly beneath the projection as an indented list.

- "3TM (Alberta)"
 - 111W (112.5W - 109.5W)
 - 114W (115.5W - 112.5W)
 - 117W (118.5W - 115.5W)
 - 120W (121.5W - 118.5W)
- "10TM (Alberta)"
 - Resource (False Easting 0)
 - Resource (False Easting 500,000)
- "Aitoff-Wagner"
- "Alaska Conformal"
- "Albers Conic"
- "Austrian Grid"
 - Zone M28 (Western Austria) - Bundesmeldenetz
 - Zone M31 (Central Austria) - Bundesmeldenetz
 - Zone M34 (Eastern Austria) - Bundesmeldenetz
 - Zone M28 (Western Austria) - Gebrauchskoordinaten
 - Zone M31 (Central Austria) - Gebrauchskoordinaten
 - Zone M34 (Eastern Austria) - Gebrauchskoordinaten
- "Azimuthal Equidistant"
- "Belge 1972 (Belgium Lambert 1972)"
- "Bipolar Oblique Conic West"
- "Bonne"
- "British Grid"
- "Cassini Malaysia"
 - Johor State
 - Kedah & Perlis States
 - Kelantan State
 - N Sembilan & Melaka States
 - Pehang State
 - Perak State
 - Palau Pinang State
 - Selangor State
 - Singapore
 - Terengganu State
- "Cassini-Soldner"
- "Croatia (TM)"
- "Double Stereographic"

- "Dutch Grid (RD)"
- "Eckert IV"
- "Equidistant Conic A"
- "Equidistant Conic B"
- "Equirectangular"
- "Gall Stereographic"
- "Gauss Boaga (Italia)"
 - Fuso Ovest (6E - 12E)
 - Fuso Est (12E - 18E)
- "Gauss Krueger (6 degree zones)"
 - Zone 1 (0E - 6E)
 - Zone 2 (6E - 12E)
 - Zone 3 (12E - 18E)
 - Zone 4 (18E - 24E)
 - Zone 5 (24E - 30E)
 - Zone 6 (30E - 36E)
 - Zone 7 (36E - 42E)
 - Zone 8 (42E - 48E)
 - Zone 9 (48E - 54E)
 - Zone 10 (54E - 60E)
 - Zone 11 (60E - 66E)
 - Zone 12 (66E - 72E)
 - Zone 13 (72E - 78E)
 - Zone 14 (78E - 84E)
 - Zone 15 (84E - 90E)
 - Zone 16 (90E - 96E)
 - Zone 17 (96E - 102E)
 - Zone 18 (102E - 108E)
 - Zone 19 (108E - 114E)
 - Zone 20 (114E - 120E)
 - Zone 21 (120E - 126E)
 - Zone 22 (126E - 132E)
 - Zone 23 (132E - 138E)
 - Zone 24 (138E - 144E)
 - Zone 25 (144E - 150E)
 - Zone 26 (150E - 156E)
 - Zone 27 (156E - 162E)
 - Zone 28 (162E - 168E)
 - Zone 29 (168E - 174E)
 - Zone 30 (174E - 180E)
 - Zone 31 (180W - 174W)
 - Zone 32 (174W - 168W)

- Zone 33 (168W - 162W)
- Zone 34 (162W - 156W)
- Zone 35 (156W - 150W)
- Zone 36 (150W - 144W)
- Zone 37 (144W - 138W)
- Zone 38 (138W - 132W)
- Zone 39 (132W - 126W)
- Zone 40 (126W - 120W)
- Zone 41 (120W - 114W)
- Zone 42 (114W - 108W)
- Zone 43 (108W - 102W)
- Zone 44 (102W - 96W)
- Zone 45 (96W - 90W)
- Zone 46 (90W - 84W)
- Zone 47 (84W - 78W)
- Zone 48 (78W - 72W)
- Zone 49 (72W - 66W)
- Zone 50 (66W - 60W)
- Zone 51 (60W - 54W)
- Zone 52 (54W - 48W)
- Zone 53 (48W - 42W)
- Zone 54 (42W - 36W)
- Zone 55 (36W - 30W)
- Zone 56 (30W - 24W)
- Zone 57 (24W - 18W)
- Zone 58 (18W - 12W)
- Zone 59 (12W - 6W)
- Zone 60 (6W - 0E)

- "Gauss Krueger (Argentina)"
 - Zone 1 (73.5W - 70.5W)
 - Zone 2 (70.5W - 67.5W)
 - Zone 3 (67.5W - 64.5W)
 - Zone 4 (64.5W - 61.5W)
 - Zone 5 (61.5W - 58.5W)
 - Zone 6 (58.5W - 55.5W)
 - Zone 7 (55.5W - 52.5W)

- "Gauss Krueger (Croatia) - HDKS"
 - Zone 5 (13.5E - 16.5E)
 - Zone 6 (16.5E - 19.5E)
 - Zone 7 (19.5E - 22.5E)

- "Gauss Krueger (3 degree zones)"

- Zone 1 (1.5E - 4.5E)
- Zone 2 (4.5E - 7.5E)
- Zone 3 (7.5E - 10.5E)
- Zone 4 (10.5E - 13.5E)
- Zone 5 (13.5E - 16.5E)
- Zone 6 (16.5E - 19.5E)
- Zone 7 (19.5E - 22.5E)
- Zone 8 (22.5E - 25.5E)
- Zone 9 (25.5E - 28.5E)
- Zone 10 (28.5E - 31.5E)
- Zone 11 (31.5E - 34.5E)
- Zone 12 (34.5E - 37.5E)
- Zone 13 (37.5E - 40.5E)
- Zone 14 (40.5E - 43.5E)
- Zone 15 (43.5E - 46.5E)
- Zone 16 (46.5E - 49.5E)
- Zone 17 (49.5E - 52.5E)
- Zone 18 (52.5E - 55.5E)
- Zone 19 (55.5E - 58.5E)
- Zone 20 (58.5E - 61.5E)
- Zone 21 (61.5E - 64.5E)
- Zone 22 (64.5E - 67.5E)
- Zone 23 (67.5E - 70.5E)
- Zone 24 (70.5E - 73.5E)
- Zone 25 (73.5E - 76.5E)
- Zone 26 (76.5E - 79.5E)
- Zone 27 (79.5E - 82.5E)
- Zone 28 (82.5E - 85.5E)
- Zone 29 (85.5E - 88.5E)
- Zone 30 (88.5E - 91.5E)
- Zone 31 (91.5E - 94.5E)
- Zone 32 (94.5E - 97.5E)
- Zone 33 (97.5E - 100.5E)
- Zone 34 (100.5E - 103.5E)
- Zone 35 (103.5E - 106.5E)
- Zone 36 (106.5E - 109.5E)
- Zone 37 (109.5E - 112.5E)
- Zone 38 (112.5E - 115.5E)
- Zone 39 (115.5E - 118.5E)
- Zone 40 (118.5E - 121.5E)
- Zone 41 (121.5E - 124.5E)
- Zone 42 (124.5E - 127.5E)

- Zone 43 (127.5E - 130.5E)
- Zone 44 (130.5E - 133.5E)
- Zone 45 (133.5E - 136.5E)
- Zone 46 (136.5E - 139.5E)
- Zone 47 (139.5E - 142.5E)
- Zone 48 (142.5E - 145.5E)
- Zone 49 (145.5E - 148.5E)
- Zone 50 (148.5E - 151.5E)
- Zone 51 (151.5E - 154.5E)
- Zone 52 (154.5E - 157.5E)
- Zone 53 (157.5E - 160.5E)
- Zone 54 (160.5E - 163.5E)
- Zone 55 (163.5E - 166.5E)
- Zone 56 (166.5E - 169.5E)
- Zone 57 (169.5E - 172.5E)
- Zone 58 (172.5E - 175.5E)
- Zone 59 (175.5E - 178.5E)
- Zone 60 (178.5E - 181.5E)

- "Gauss Krueger Slovenia"
- "Geographic (Latitude/Longitude)"
- "Gnomonic"
- "Greek Grid"
- "Hammer-Aitoff"
- "Hotine Oblique Mercator A"
- "Hotine Oblique Mercator B"
- "Hotine Oblique Azimuth Nat. Orig."
- "Interrupted Goode Homolosine"
- "Hungarian National Grid (EOV)"
- "India Zoned Grid"
 - India 0
 - India I
 - India IIa
 - India IIb
 - India IIIa
 - India IIIb
 - India IVa
 - India IVb

- "Irish Grid"
- "Israel Grid (New)"
- "Israel Grid (Old)"
- "Japanese Projection System"

- Japanese Plane I
- Japanese Plane II
- Japanese Plane III
- Japanese Plane IV
- Japanese Plane V
- Japanese Plane VI
- Japanese Plane VII
- Japanese Plane VIII
- Japanese Plane IX
- Japanese Plane X
- Japanese Plane XI
- Japanese Plane XII
- Japanese Plane XIII
- Japanese Plane XIV
- Japanese Plane XV
- Japanese Plane XVI
- Japanese Plane XVII
- Japanese Plane XVIII
- Japanese Plane XIX

- "Korea TM"
 - Korea West Belt (124.0E - 126.0E)
 - Korea Central Belt (126.0E - 128.0E)
 - Korea East Belt (128.0E - 130.0E)
 - Korea East Sea Belt (130.0E - 132.0E)

- "Krovak"
- "Laborde (Madagascar)"
- "Lambert Azimuthal Equal-Area"
- "Lambert Conformal Conic"
- "Lambert Cylindrical Equal-Area"
- "Lambert (Marta Software)"
- "Lambert (NOAA Port)"
- "Lambert I Carto (Northern France)"
- "Lambert I Nord (Northern France)"
- "Lambert II Centre (Central France)"
- "Lambert II Carto Étendu (Wide)"
- "Lambert III Carto (Southern France)"
- "Lambert III Sud (Southern France)"
- "Lambert IV Carto (Corsica)"
- "Lambert IV Corse (Corsica)"
- "Lambert-93"
 - Base Lambert93

- CC-42
- CC-43
- CC-44
- CC-45
- CC-46
- CC-47
- CC-48
- CC-49
- CC-50

- "Marta Software Satellite"
- "Mercator"
- "Mercator (Lowrance Special)"
- "Mercator (Navionics Special)"
- "MGA (Map Grid of Australia)"
 - MGA Zone 48 (102.0E - 108.0E)
 - MGA Zone 49 (108.0E - 114.0E)
 - MGA Zone 50 (114.0E - 120.0E)
 - MGA Zone 51 (120.0E - 126.0E)
 - MGA Zone 52 (126.0E - 132.0E)
 - MGA Zone 53 (132.0E - 138.0E)
 - MGA Zone 54 (138.0E - 144.0E)
 - MGA Zone 55 (144.0E - 150.0E)
 - MGA Zone 56 (150.0E - 156.0E)
 - MGA Zone 57 (156.0E - 162.0E)
 - MGA Zone 58 (162.0E - 168.0E)

- "Michigan Georef"
- "Miller Cylindrical"
- "Miller Oblated Stereographic"
- "Minnesota County"
 - Aitkin
 - Anoka
 - Becker
 - Beltrami North
 - Beltrami South
 - Benton
 - Big Stone
 - Blue Earth
 - Brown
 - Carlton
 - Carver
 - Cass North

- Cass South
- Chipewa
- Chisago
- Clay
- Clearwater
- Cook North
- Copok South
- Cottonwood
- Crow Wing
- Dakota
- Dodge
- Douglas
- Faribault
- Fillmore
- Freeborn
- Goodhue
- Grant
- Hennepin
- Houston
- Hubbard
- Isanti
- Itasca North
- Itasca South
- Jackson
- Kanabec
- Kandiyohi
- Kittson
- Koochiching
- Lac Qui Parle
- Lake
- Lake of the Woods North
- Lake of the Woods South
- Le Sueur
- Lincoln
- Lyon
- Mahnomen
- Marshall
- Martin
- McLeod
- Meeker
- Mille Lacs
- Morrison

- Mower
- Murray
- Nicollet
- Nobles
- Norman
- Olmsted
- Ottertail
- Pennington
- Pine
- Pipestone
- Polk
- Pope
- Ramsey
- Redlake
- Redwood
- Renville
- Rice
- Rock
- Roseau
- St Louis North
- St Louis Central
- St Louis South
- Scott
- Sherburne
- Sibley
- Stearns
- Steele
- Stevens
- Swift
- Todd
- Traverse
- Wabasha
- Wadena
- Waseca
- Washington
- Watonwan
- Wilkin
- Winona
- Wright
- Yellow Medicine

- "Mollweide"
- "MSTM (Mississippi Transverse Mercator)"

- "MTM (Eastern Canada)"
 - Zone 1 (54.5W - 51.5W)
 - Zone 2 (57.5W - 54.5W)
 - Zone 3 (60.0W - 57.5W)
 - Zone 4 (63.0W - 60.0W)
 - Zone 5 (66.0W - 63.0W)
 - Zone 6 (69.0W - 66.0W)
 - Zone 7 (72.0W - 69.0W)
 - Zone 8 (75.0W - 72.0W)
 - Zone 9 (78.0W - 75.0W)
 - Zone 10 (81.0W - 78.0W)
 - Zone 11 (84.0W - 81.0W)
 - Zone 12 (82.5W - 79.5W)
 - Zone 13 (85.5W - 82.5W)
 - Zone 14 (88.5W - 85.5W)
 - Zone 15 (91.5W - 88.5W)
 - Zone 16 (94.5W - 91.5W)
 - Zone 17 (97.5W - 94.5W)
- "Natural Earth"
- "New Brunswick Double Stereographic"
- "Norwegian Transverse Mercator (NTM)"
 - Zone 5 (5E - 6E)
 - Zone 6 (6E - 7E)
 - Zone 7 (7E - 8E)
 - Zone 8 (8E - 9E)
 - Zone 9 (9E - 10E)
 - Zone 10 (10E - 11E)
 - Zone 11 (11E - 12E)
 - Zone 12 (12E - 13E)
 - Zone 13 (13E - 14E)
 - Zone 14 (14E - 15E)
 - Zone 15 (15E - 16E)
 - Zone 16 (16E - 17E)
 - Zone 17 (17E - 18E)
 - Zone 18 (18E - 19E)
 - Zone 19 (19E - 20E)
 - Zone 20 (20E - 21E)
 - Zone 21 (21E - 22E)
 - Zone 22 (22E - 23E)
 - Zone 23 (23E - 24E)
 - Zone 24 (24E - 25E)
 - Zone 25 (25E - 26E)

- Zone 26 (26E - 27E)
- Zone 27 (27E - 28E)
- Zone 28 (28E - 29E)
- Zone 29 (29E - 30E)
- Zone 30 (30E - 31E)

- "New Zealand Map Grid"
- "[New Zealand Transverse Mercator 2000](#)"
- "Oblique Stereographic"
- "Orthographic"
- "Philippines Grid"
 - Zone 1
 - Zone 2
 - Zone 3
 - Zone 4
 - Zone 5

- "Plate Carree (Geographic)"
- "Poland 1992/19"
- "Poland 2000"
 - Zone 5 (13.5E - 16.5E)
 - Zone 6 (16.5E - 19.5E)
 - Zone 7 (19.5E - 22.5E)
 - Zone 8 (22.5E - 25.5E)

- "Polar Stereographic"
- "Polyconic"
- "Robinson"
- "Rectified Skew Orthomorphic (RSO)"
- "RSO East Malaysia (Borneo)"
- "RSO West Malaysia (Peninsular)"
- "Sinusoidal"
- "Sinusoidal (Integerized)"
- "State Plane Coordinate System"
 - Alabama East (FIPS 101)
 - Alabama West(FIPS 102)
 - Alaska Zone 1 (FIPS 5001)
 - Alaska Zone 2 (FIPS 5002)
 - Alaska Zone 3 (FIPS 5003)
 - Alaska Zone 4 (FIPS 5004)
 - Alaska Zone 5 (FIPS 5005)
 - Alaska Zone 6 (FIPS 5006)
 - Alaska Zone 7 (FIPS 5007)

- Alaska Zone 8 (FIPS 5008)
- Alaska Zone 9 (FIPS 5009)
- Alaska Zone 10 (FIPS 5010)
- Arizona East (FIPS 201)
- Arizona Central (FIPS 202)
- Arizona West (FIPS 203)
- Arkansas North (FIPS 301)
- Arkansas South (FIPS 302)
- California Zone 1 (FIPS 401)
- California Zone 2 (FIPS 402)
- California Zone 3 (FIPS 403)
- California Zone 4 (FIPS 404)
- California Zone 5 (FIPS 405)
- California Zone 6 (FIPS 406)
- Colorado North (FIPS 501)
- Colorado Central (FIPS 502)
- Colorado South (FIPS 503)
- Connecticut (FIPS 600)
- Delaware (FIPS 700)
- District of Columbia/Maryland (FIPS 1900)
- Florida East (FIPS 901)
- Florida West (FIPS 902)
- Florida North (FIPS 903)
- Georgia East (FIPS 1001)
- Georgia West (FIPS 1002)
- Hawaii Zone 1 (FIPS 5101)
- Hawaii Zone 2 (FIPS 5102)
- Hawaii Zone 3 (FIPS 5103)
- Hawaii Zone 4 (FIPS 5104)
- Hawaii Zone 5 (FIPS 5105)
- Idaho East (FIPS 1101)
- Idaho Central (FIPS 1102)
- Idaho West (FIPS 1103)
- Illinois East (FIPS 1201)
- Illinois West (FIPS 1202)
- Indiana East (FIPS 1301)
- Indiana West (FIPS 1302)
- Iowa North (FIPS 1401)
- Iowa South (FIPS 1402)
- Kansas North (FIPS 1501)
- Kansas South (FIPS 1502)
- Kentucky (FIPS 1600)

- Kentucky North (FIPS 1601)
- Kentucky South (FIPS 1602)
- Louisiana North (FIPS 1701)
- Louisiana South (FIPS 1702)
- Louisiana Offshore (FIPS 1703)
- Maine East (FIPS 1801)
- Maine West (FIPS 1802)
- Maine CS2000 East (FIPS 1803)
- Maine CS2000 Central (FIPS 1804)
- Maine CS2000 West (FIPS 1805)
- Maryland/District of Columbia (FIPS 1900)
- Massachusetts Mainland (FIPS 2001)
- Massachusetts Island (FIPS 2002)
- Michigan North (FIPS 2111)
- Michigan Central (FIPS 2112)
- Michigan South (FIPS 2113)
- Minnesota North (FIPS 2201)
- Minnesota Central (FIPS 2202)
- Minnesota South (FIPS 2203)
- Mississippi East (FIPS 2301)
- Mississippi West (FIPS 2302)
- Missouri East (FIPS 2401)
- Missouri Central (FIPS 2402)
- Missouri West (FIPS 2403)
- Montana (FIPS 2500)
- Nebraska (FIPS 2600)
- Nevada East (FIPS (2701)
- Nevada Central (FIPS (2702)
- Nevada West (FIPS (2703)
- New Hampshire (FIPS 2800)
- New Jersey (FIPS 2900)
- New Mexico East (FIPS 3001)
- New Mexico Central (FIPS 3002)
- New Mexico West (FIPS 3003)
- New York East (FIPS 3101)
- New York Central (FIPS 3102)
- New York West (FIPS 3103)
- New York - Long Island (FIPS 3104)
- North Carolina (FIPS 3200)
- North Dakota North (FIPS 3301)
- North Dakota South(FIPS 3302)
- Ohio North (FIPS 3401)

- Ohio South (FIPS 3402)
- Oklahoma North (FIPS 3501)
- Oklahoma South (FIPS 3502)
- Oregon North (FIPS 3601)
- Oregon South (FIPS 3602)
- Pennsylvania North (FIPS 3701)
- Pennsylvania South (FIPS 3702)
- Rhode Island (FIPS 3800)
- South Carolina (FIPS 3900)
- South Dakota North (FIPS 4001)
- South Dakota South (FIPS 4002)
- Tennessee (FIPS 4100)
- Texas North (FIPS 4201)
- Texas North Central (FIPS 4202)
- Texas Central (FIPS 4203)
- Texas South Central (FIPS 4204)
- Texas South (FIPS 4205)
- Utah North (FIPS 4301)
- Utah Central (FIPS 4302)
- Utah South (FIPS 4303)
- Vermont (FIPS 4400)
- Virginia North (FIPS 4501)
- Virginia South (FIPS 4502)
- Washington North (FIPS 4601)
- Washington South (FIPS 4602)
- West Virginia North (FIPS 4701)
- West Virginia South (FIPS 4702)
- Wisconsin North (FIPS 4801)
- Wisconsin Central (FIPS 4802)
- Wisconsin South (FIPS 4803)
- Wyoming East (FIPS 4901)
- Wyoming East Central (FIPS 4902)
- Wyoming West Central (FIPS 4903)
- Wyoming West (FIPS 4904)
- Puerto Rico/Virgin Islands (FIPS 5200)

- "Stereo70"
- "Stereographic"
- "Swedish Grid (RT90)"
- "Swedish Grid (SWEREF99)"
 - SWEREF 99 TM
 - SWEREF 99 12 00
 - SWEREF 99 13 30

- SWEREF 99 15
- SWEREF 99 16 30
- SWEREF 99 18
- SWEREF 99 14 15
- SWEREF 99 15 45
- SWEREF 99 17 15
- SWEREF 99 18 45
- SWEREF 99 20 15
- SWEREF 99 21 45
- SWEREF 99 23 15
- "Swiss Grid"
- "Swiss Grid (LV95)"
- "System 1965 (Uklad 1965) [Poland]"
 - Zone (Strefa) 1
 - Zone (Strefa) 2
 - Zone (Strefa) 3
 - Zone (Strefa) 4
 - Zone (Strefa) 5
- "Times"
- "Transverse Mercator"
- "Transverse Mercator (South-Oriented)"
- "Trinidad Grid"
- "Two Point Equidistant"
- "UPS North (Univ. Polar Stereographic)"
- "UPS South (Univ. Polar Stereographic)"
- "UTM"
 - -60 (174°E - 180°E - Southern Hemisphere)
 - -59 (168°E - 174°E - Southern Hemisphere)
 - -58 (162°E - 168°E - Southern Hemisphere)
 - -57 (156°E - 162°E - Southern Hemisphere)
 - -56 (150°E - 156°E - Southern Hemisphere)
 - -55 (144°E - 150°E - Southern Hemisphere)
 - -54 (138°E - 144°E - Southern Hemisphere)
 - -53 (132°E - 138°E - Southern Hemisphere)
 - -52 (126°E - 132°E - Southern Hemisphere)
 - -51 (120°E - 126°E - Southern Hemisphere)
 - -50 (114°E - 120°E - Southern Hemisphere)
 - -49 (108°E - 114°E - Southern Hemisphere)
 - -48 (102°E - 108°E - Southern Hemisphere)
 - -47 (96°E - 102°E - Southern Hemisphere)
 - -46 (90°E - 96°E - Southern Hemisphere)

- -45 (84°E - 90°E - Southern Hemisphere)
- -44 (78°E - 84°E - Southern Hemisphere)
- -43 (72°E - 78°E - Southern Hemisphere)
- -42 (66°E - 72°E - Southern Hemisphere)
- -41 (60°E - 66°E - Southern Hemisphere)
- -40 (54°E - 60°E - Southern Hemisphere)
- -39 (48°E - 54°E - Southern Hemisphere)
- -38 (42°E - 48°E - Southern Hemisphere)
- -37 (36°E - 42°E - Southern Hemisphere)
- -36 (30°E - 36°E - Southern Hemisphere)
- -35 (24°E - 30°E - Southern Hemisphere)
- -34 (18°E - 24°E - Southern Hemisphere)
- -33 (12°E - 18°E - Southern Hemisphere)
- -32 (6°E - 12°E - Southern Hemisphere)
- -31 (0°E - 6°E - Southern Hemisphere)
- -30 (6°W - 0°W - Southern Hemisphere)
- -29 (12°W - 6°W - Southern Hemisphere)
- -28 (18°W - 12°W - Southern Hemisphere)
- -27 (24°W - 18°W - Southern Hemisphere)
- -26 (30°W - 24°W - Southern Hemisphere)
- -25 (36°W - 30°W - Southern Hemisphere)
- -24 (42°W - 36°W - Southern Hemisphere)
- -23 (48°W - 42°W - Southern Hemisphere)
- -22 (54°W - 48°W - Southern Hemisphere)
- -21 (60°W - 54°W - Southern Hemisphere)
- -20 (66°W - 60°W - Southern Hemisphere)
- -19 (72°W - 66°W - Southern Hemisphere)
- -18 (78°W - 72°W - Southern Hemisphere)
- -17 (84°W - 78°W - Southern Hemisphere)
- -16 (90°W - 84°W - Southern Hemisphere)
- -15 (96°W - 90°W - Southern Hemisphere)
- -14 (102°W - 96°W - Southern Hemisphere)
- -13 (108°W - 102°W - Southern Hemisphere)
- -12 (114°W - 108°W - Southern Hemisphere)
- -11 (120°W - 114°W - Southern Hemisphere)
- -10 (126°W - 120°W - Southern Hemisphere)
- -9 (132°W - 126°W - Southern Hemisphere)
- -8 (138°W - 132°W - Southern Hemisphere)
- -7 (144°W - 138°W - Southern Hemisphere)
- -6 (150°W - 144°W - Southern Hemisphere)
- -5 (156°W - 150°W - Southern Hemisphere)
- -4 (162°W - 156°W - Southern Hemisphere)

- -3 (168°W - 162°W - Southern Hemisphere)
- -2 (174°W - 168°W - Southern Hemisphere)
- -1 (180°W - 174°W - Southern Hemisphere)
- 1 (180°W - 174°W - Northern Hemisphere)
- 2 (174°W - 168°W - Northern Hemisphere)
- 3 (168°W - 162°W - Northern Hemisphere)
- 4 (162°W - 156°W - Northern Hemisphere)
- 5 (156°W - 150°W - Northern Hemisphere)
- 6 (150°W - 144°W - Northern Hemisphere)
- 7 (144°W - 138°W - Northern Hemisphere)
- 8 (138°W - 132°W - Northern Hemisphere)
- 9 (132°W - 126°W - Northern Hemisphere)
- 10 (126°W - 120°W - Northern Hemisphere)
- 11 (120°W - 114°W - Northern Hemisphere)
- 12 (114°W - 108°W - Northern Hemisphere)
- 13 (108°W - 102°W - Northern Hemisphere)
- 14 (102°W - 96°W - Northern Hemisphere)
- 15 (96°W - 90°W - Northern Hemisphere)
- 16 (90°W - 84°W - Northern Hemisphere)
- 17 (84°W - 78°W - Northern Hemisphere)
- 18 (78°W - 72°W - Northern Hemisphere)
- 19 (72°W - 66°W - Northern Hemisphere)
- 20 (66°W - 60°W - Northern Hemisphere)
- 21 (60°W - 54°W - Northern Hemisphere)
- 22 (54°W - 48°W - Northern Hemisphere)
- 23 (48°W - 42°W - Northern Hemisphere)
- 24 (42°W - 36°W - Northern Hemisphere)
- 25 (36°W - 30°W - Northern Hemisphere)
- 26 (30°W - 24°W - Northern Hemisphere)
- 27 (24°W - 18°W - Northern Hemisphere)
- 28 (18°W - 12°W - Northern Hemisphere)
- 29 (12°W - 6°W - Northern Hemisphere)
- 30 (6°W - 0°W - Northern Hemisphere)
- 31 (0°E - 6°E - Northern Hemisphere)
- 32 (6°E - 12°E - Northern Hemisphere)
- 33 (12°E - 18°E - Northern Hemisphere)
- 34 (18°E - 24°E - Northern Hemisphere)
- 35 (24°E - 30°E - Northern Hemisphere)
- 36 (30°E - 36°E - Northern Hemisphere)
- 37 (36°E - 42°E - Northern Hemisphere)
- 38 (42°E - 48°E - Northern Hemisphere)
- 39 (48°E - 54°E - Northern Hemisphere)

- 40 (54°E - 60°E - Northern Hemisphere)
- 41 (60°E - 66°E - Northern Hemisphere)
- 42 (66°E - 72°E - Northern Hemisphere)
- 43 (72°E - 78°E - Northern Hemisphere)
- 44 (78°E - 84°E - Northern Hemisphere)
- 45 (84°E - 90°E - Northern Hemisphere)
- 46 (90°E - 96°E - Northern Hemisphere)
- 47 (96°E - 102°E - Northern Hemisphere)
- 48 (102°E - 108°E - Northern Hemisphere)
- 49 (108°E - 114°E - Northern Hemisphere)
- 50 (114°E - 120°E - Northern Hemisphere)
- 51 (120°E - 126°E - Northern Hemisphere)
- 52 (126°E - 132°E - Northern Hemisphere)
- 53 (132°E - 138°E - Northern Hemisphere)
- 54 (138°E - 144°E - Northern Hemisphere)
- 55 (144°E - 150°E - Northern Hemisphere)
- 56 (150°E - 156°E - Northern Hemisphere)
- 57 (156°E - 162°E - Northern Hemisphere)
- 58 (162°E - 168°E - Northern Hemisphere)
- 59 (168°E - 174°E - Northern Hemisphere)
- 60 (174°E - 180°E - Northern Hemisphere)

- "Van der Grinten"
- "Vertical Near-Side Perspective"
- "Wagner VII (Hammer-Wagner)"
- "Winkel I"
- "Winkel Tripel"
- "Wisconsin County Reference System (WISCRS)"
 - Adams County
 - Ashland County
 - Barron County
 - Bayfield County
 - Brown County
 - Buffalo County
 - Burnett County
 - Calumet County
 - Chipewa County
 - Clark County
 - Columbia County
 - Crawford County
 - Dodge County
 - Door County
 - Douglas County

- Dunn County
- Eau Claire County
- Florence County
- Fon du Lac
- Forrest County
- Grant County
- Green County
- Green Lake County
- Iowa County
- Iron County
- Jackson County
- Jefferson County
- Juneau County
- Kenosha County
- Kewanee County
- La Crosse County
- Lafayette County
- Langlade County
- Lincoln County
- Manitowoc County
- Marathon County
- Marinette County
- Marquette County
- Menominee County
- Milwaukee County
- Monroe County
- Oconto County
- Oneida County
- Outagamie County
- Ozaukee County
- Peppin County
- Pierce County
- Polk County
- Portage County
- Price County
- Racine County
- Richland County
- Rock County
- Rusk County
- Sauk County
- Sawyer County
- Shawano County

- Sheboygan County
- St Croix County
- Taylor County
- Trempealeau County
- Vernon County
- Vilas County
- Walworth County
- Washburn County
- Washington County
- Waukesha County
- Waupaca County
- Waushara County
- Winnebago County
- Wood County
- "WTM83/91 (Wisc. Transverse Mercator)"

To the right of the *Projection* drop-down are three buttons:

- **Load From File...**: Allows a projection to be loaded from an external file. The accepted file formats are PRJ and SPR (PRJ is preferable).
- **Save to File...**: Allows the projection information set in this dialog to be saved as a PRJ file.
- **Init from EPSG...**: Opens a dialog where an [EPSG Projection Code](#) can be entered.

Datum

Datums in *italics* are not actual options. The available options for that entry are listed in the indented list directly below it.

List of Datums
<ul style="list-style-type: none"> • Adindan • Ain el Abd (Bahrain) • Ain el Abd (Saudi Arabia) • American Samoa 1962 - NADCON • Aratu (Brazil) • ARC1950 • ARC1960 • Astro B4 (Sorol Atoll) • Astro Beacon

- Astro DOS 71/4
- Astronomic Station 1952
- ATS77 (Nova Scotia) - NTv2 Grid
- Australian Geodetic 1966 - NTv2 Grid
- Australian Geodetic 1984 - NTv2 Grid
- BD72 (Belgium 1972)
- Beijing 1954
- Bessel 1841 (Italia) [Castanea d. F]
- Bessel 1841 (Italia) [Genova]
- Bessel 1841 (Italia) [Monte Mario]
- Bessel 1841 [Greenwich]
- Bogota Observatory
- Bukit Rimpah
- Camacupa
- Camp Area Astro
- Campo Inchauspe (Argentina)
- Cape
- Carthage
- Chad (WG1998)
- Clarke 1866 Authalic Sphere
- Combani 1950 (Mayotte)
- Corrego Alegre (Brazil)
- Croatia HDKS Grid
- CSJ 67 (Gayane Francaise)
- D-48 Slovenia
- Dealul Piscului 1933 (Romania)
- Dealul Piscului 1970
- Deir Ez Zor (Syria)
- Dutch (RD)
- Easter Island 1967
- ED50
 - ED50 (England)
 - ED50 (Finland/Norway)
 - ED50 (Greece)
 - ED50 (Italia)
 - ED50 (Malta)
 - ED50 (North Sea)
 - ED50 (Norway Offshore - N62)
 - ED50 (Norway Offshore - S62)
 - ED50 (Sicilia)
 - ED50 (Spain/Portugal) - NTv2 Grid
 - ED50 (Turkey)

- ED79
- ED87
- Egypt 1907
- Egypt Gulf of Suez S-650 TL
- Estionia 1997
- ETRF2000 - RDN
- ETRS89
- FD 1958 (Iraq)
- Finland/Hayford
- Fort Marigot (St Maarten)
- GDA 94 (Australian Geodetic 1994)
- GDM2000 (Malaysia)
- GGRS87 (Greece)
- Google Maps (Sphere Radius 6378137)
- GRS80 Ellipsoid
- Guadeloupe 1948
- Guam 1963
- Hartebeesthoek 1994 (S. Africa)
- Herat North (Afghanistan)
- Hermannskogel
- HJorsey 1955
- Hong Kong 1963
- Hong Kong 1980
- Hu Tzu Shan
- Hungarian Datum 1972
- IGN72 Grande Terre (New Caledonia)
- *Indian:*
 - Indian (Bangladesh)
 - Indian (Mean Value)
 - Indian (Nepal)
 - Indian (Thailand)
 - Indian 1954
 - Indian 1960
 - Indian 1975
- Indonesia 1974
- Ireland 1965
- Ireland 1965 (1975 Adjustment)
- Irenet95
- ISN93 (Iceland)
- ISTS 073 Astro
- JAD2001 (Jamaica 2001)
- JAD69 (Jamaica 1969)

- JGD2000 (Japan)
- Jordan
- Kertau 1948
- Kertau 1948 (Malaysia)
- KKJ (Finnish Grid)
- Korean 1985
- Korean 1995
- Korean Geodetic Datum (KGD)
- Krasovsky 1940
- La Canoa (Venezuela)
- Le Pouce 1934 (Mauritius)
- Leigon (Ghana)
- Lisbon/Lisboa 1937 (DLx)
- LKS92 (Latvia)
- Lowrance
- Luref (Luxembourg)
- Luzon (Philippines)
- M'Poraloko (Gabon)
- Malongo 1987
- Martinique 1938
- Merchich (Morocco)
- MGI Austria
- MGI Croatia/Serbia
- MGI Slovenia
- Minna (Cameroon)
- Minna (Nigeria)
- *MN County:*
 - MN County (Anoka)
 - MN County (Becker)
 - MN County (Beltrami North)
 - MN County (Beltrami South)
 - MN County (Benton)
 - MN County (Big Stone)
 - MN County (Blue Earth)
 - MN County (Brown)
 - MN County (Carlton)
 - MN County (Carver)
 - MN County (Cass North)
 - MN County (Cass South)
 - MN County (Chippewa)
 - MN County (Chisago)
 - MN County (Cook North)

- MN County (Cook South)
- MN County (Cottonwood)
- MN County (Crow Wing)
- MN County (Dakota)
- MN County (Dodge)
- MN County (Douglas)
- MN County (Faribault)
- MN County (Fillmore)
- MN County (Freeborn)
- MN County (Goodhue)
- MN County (Grant)
- MN County (Hennepin)
- MN County (Houston)
- MN County (Isanti)
- MN County (Itasca North)
- MN County (Itasca South)
- MN County (Jackson)
- MN County (Kanabec)
- MN County (Kandiyohi)
- MN County (Kittson)
- MN County (Koochiching)
- MN County (Lac Qui Parle)
- MN County (Lake of the Woods North)
- MN County (Lake of the Woods South)
- MN County (Le Sueur)
- MN County (Lincoln)
- MN County (Lyon)
- MN County (Mahnommen)
- MN County (Marshall)
- MN County (Martin)
- MN County (McLeod)
- MN County (Meeker)
- MN County (Morrison)
- MN County (Mower)
- MN County (Murray)
- MN County (Nicollet)
- MN County (Nobles)
- MN County (Norman)
- MN County (Olmsted)
- MN County (Ottertail)
- MN County (Pennington)
- MN County (Pine)

- MN County (Pipestone)
- MN County (Polk)
- MN County (Pope)
- MN County (Ramsey)
- MN County (Red Lake)
- MN County (Redwood)
- MN County (Renville)
- MN County (Rice)
- MN County (Rock)
- MN County (Roseau)
- MN County (Sherburne)
- MN County (Sibley)
- MN County (St Louis Central)
- MN County (St Louis North)
- MN County (St Louis South)
- MN County (Stearns)
- MN County (Steele)
- MN County (Stevens)
- MN County (Swift)
- MN County (Todd)
- MN County (Traverse)
- MN County (Wabasha)
- MN County (Wadena)
- MN County (Waseca)
- MN County (Watonwan)
- MN County (Winona)
- MN County (Wright)
- MN County (Yellow Medicine)

- Modis Spheroid (6371007.181 M)
- NAD27
 - NAD27 (Alaska)
 - NAD27 (Aleutian Islands East)
 - NAD27 (Aleutian Islands West)
 - NAD27 (Bahamas)
 - NAD27 (Canada)
 - NAD27 (Canal Zone)
 - NAD27 (Caribbean)
 - NAD27 (Central America)
 - NAD27 (Conus)
 - NAD27 (Cuba)
 - NAD27 (Greenland)
 - NAD27 (Mexico)

- NAD27 (Michigan)
- NAD27 (San Salvador)
- NAD27 (Yuma Proving Grounds)

- NAD83
 - NAD83 (Alabama HPGN)
 - NAD83 (Arizona HPGN)
 - NAD83 (Arkansas HPGN)
 - NAD83 (California North HPGN)
 - NAD83 (California South HPGN)
 - NAD83 (Colorado HPGN)
 - NAD83 (Florida HPGN)
 - NAD83 (Georgia HPGN)
 - NAD83 (Hawaii HPGN)
 - NAD83 (Illinois HPGN)
 - NAD83 (Indiana HPGN)
 - NAD83 (Iowa HPGN)
 - NAD83 (ITRF96)
 - NAD83 (Kansas HPGN)
 - NAD83 (Kentucky HPGN)
 - NAD83 (Louisiana HPGN)
 - NAD83 (Main HPGN)
 - NAD83 (Maryland-Delaware HPGN)
 - NAD83 (Michigan HPGN)
 - NAD83 (Minnesota HPGN)
 - NAD83 (Mississippi HPGN)
 - NAD83 (Missouri HPGN)
 - NAD83 (Montana East HPGN)
 - NAD83 (Montana West-Idaho HPGN)
 - NAD83 (Nebraska HPGN)
 - NAD83 (Nevada HPGN)
 - NAD83 (New England HPGN)
 - NAD83 (New Jersey HPGN)
 - NAD83 (New Mexico HPGN)
 - NAD83 (New York HPGN)
 - NAD83 (North Carolina HPGN)
 - NAD83 (North Dakota HPGN)
 - NAD83 (Ohio HPGN)
 - NAD83 (Oklahoma HPGN)
 - NAD83 (Pennsylvania HPGN)
 - NAD83 (Puerto Rico/Virgin Islands HPGN)
 - NAD83 (South Carolina HPGN)
 - NAD83 (South Dakota HPGN)

- NAD83 (Tennessee HPGN)
- NAD83 (Texas East HPGN)
- NAD83 (Texas West HPGN)
- NAD83 (Utah HPGN)
- NAD83 (Virginia HPGN)
- NAD83 (Washington-Oregon HPGN)
- NAD83 (West Virginia HPGN)
- NAD83 (Wisconsin HPGN)
- NAD83 (Wyoming HPGN)
- NAD83 CSRS
- NAD83 CSRS (Alberta)
- NAD83 CSRS (British Columbia)
- NAD83 CSRS (New Brunswick)
- NAD83 CSRS (Quebec)
- NAD83 CSRS (Saskatchewan)

- Nahrwan
- Naparima (UAE)
- New Israeli Datum (NID)
- NGO 1948 (Greenwich Meridian)
- NGO 1948 (Oslo Meridian)
- North Sahara 1959
- North Sahara 1959 (Hassi Messaoud)
- NTF France (Greenwich Meridian)
- NTF France (Paris Meridian)
- NZGD2000
- NZGD49
- Observatorio 1966
- Ocotepaque (Costa Rica)
- Old Hawaiian Mean
- Old Israeli Datum (OID)
- Oman
- OSGB36 (7-Param Transform)
- OSGB36 (Best Transform)
- OSGB36 (NTv2 Grid)
- Pico De Las Nieves
- Pointe Noire 1948 (Congo)
- Portuguese 1973 (Datum 73)
- POSGAR94 (Argentina)
- Potsdam 1983 (Germany - Ferro)
- Potsdam/DHDN (Germany - Ferro)
- Potsdam/DHDN (Germany)
- Provisional South Chilean

- PRS92 (Philippines)
- PSAD56 (Prov. S. American 1956)
- PSD93 (Oman)
- Puerto Rico
- Qatar 1974
- QND95 (Qatar)
- Qornoq
- Reunion Island
- Reykjavik 1900
- RGF-93
- RGFG95 (Guyane)
- RGM04 (Mayotte)
- RGNC91-93 (New Caledonia)
- RGR92 (Reunion)
- RGSPN06 (St Pierre et Miquelon)
- Rome 1940 [Monte Mario] (Greenwich)
- Rome 1940 [Monte Mario] (Rome)
- RT38 (Greenwich)
- RT38 (Stockholm)
- RT90
- S-42:
 - S-42 (Pulkovo 1942)
 - S-42 Albania
 - S-42 Azerbaijan/Georgia
 - S-42 Czechoslovakia
 - S-42 Estonia
 - S-42 Germany
 - S-42 Hungary
 - S-42 Kazakhstan
 - S-42 Latvia
 - S-42 Lithuania
 - S-42 Poland
 - S-42 Romania
 - S-42 Russia
- S-JTSK (Czech Republic)
- Sao Braz
- Schwarzbeck (Namibia)
- Sirgas 2000
- Solomon 1968 (GUX 1 Astro)
- South American 1969
- South American 1969 (Brazil)
- Southeast Base

- Southwest Base
- Sphere (Radius 6378137M)
- STM1987 (DNAG)
- Sweref99 (Sweden)
- Swiss Grid (CH1903)
- Swiss Grid (CH1903+)
- Tananarive 1925 (Greenwich)
- Tananarive 1925 (Paris)
- Tete (Mozambique)
- Timbalai 1948
- Tokyo
- Trinidad 1903
- TWD67 (Taiwan)
- VN-2000 (Vietnam)
- WGS72
- WGS84
- *WI County*:
 - WI County (Burnett)
 - WI County (Chippewa)
 - WI County (Douglas)
 - WI County (Marathon)
 - WI County (Sheboygan)
 - WI County (Taylor)
- Xian 1980 (China)
- Yacare (Uruguay)
- Zanderij (Suriname)

Create New Datum Dialog

*The Create New Datum dialog which appears when the **Add Datum...** button is clicked in the Select Projection dialog.*

The *Create New Datum* dialog (right) allows for the creation of a new datum if the available datums (the list above) do not cover the needs of the project. There are a number of different fields and options in this dialog. These are detailed below:

- *Datum Name*: Enter the desired name for the new datum.
- *Abbreviation (Optional)*: An optional field for a shortened version of the *Datum Name*.
- *Prime Meridian (Degrees)*: Enter the prime meridian.
- *Ellipsoid (Spheroid) Selection*: This section consists of a drop-down list and two buttons:
 - **Add Ellipsoid...**: This button brings up the *Custom Ellipsoid Setup* dialog. It has

the following fields:

- *Ellipsoid Name*: Enter the desired name of the ellipsoid.
- *Semi-Major Axis (meters)*: Enter the length of the semi-major axis.
- The two radio button options are:
 - *Use Semi-Minor Axis of*: Enter the length of the the semi-minor axis.
 - *Use flattening of*: Enter a number representing the flattening.
- **Edit Ellipsoid...**: Allows editing of a custom ellipsoid (one created with the **Add Ellipsoid...** button).
- The drop-down list options are:

Drop-down list options

- "Airy"
- "ATS77"
- "Australian National"
- "Bessel (modified)"
- "Bessel 1841"
- "Bessel Namibia (GLM)"
- "Clarke 1858"
- "Clarke 1866"
- "Clarke 1866 (Michigan)"
- "Clarke 1880"
- "Clarke 1880 (Benoit)"
- "Clarke 1880 (IGN)"
- "Clarke 1880 (Palestine)"
- "Clarke 1880 (RGS)"
- "Danish 1876"
- "Everest 1830"
- "Everest 1830 (1937 Adjustment)"
- "Everest 1830 (1867 Definition)"
- "Everest 1830 (1975 Adjustment)"
- "Everest 1956"
- "GRS 1967 (Indonesia 1974)"
- "GRS 1967 Modified"
- "GRS 1980"
- "Helmert 1906"

- "Hough"
- "International 1909 (Hayford/Intl 1924)"
- "International 1967"
- "Krassovsky"
- "Mercury 1960"
- "MN County - Anoka"
- "MN County - Becker"
- "MN County - Beltrami North"
- "MN County - Beltrami South"
- "MN County - Benton"
- "MN County - Big Stone"
- "MN County - Blue Earth"
- "MN County - Brown"
- "MN County - Carlton"
- "MN County - Carver"
- "MN County - Cass North"
- "MN County - Cass South"
- "MN County - Chipewa"
- "MN County - Chisago"
- "MN County - Cook North"
- "MN County - Cook South"
- "MN County - Cottonwood"
- "MN County - Crow Wing"
- "MN County - Dakota"
- "MN County - Dodge"
- "MN County - Douglas"
- "MN County - Faribault"
- "MN County - Fillmore"
- "MN County - Freeborn"
- "MN County - Goodhue"
- "MN County - Grant"
- "MN County - Hennepin"
- "MN County - Houston"
- "MN County - Isanti"
- "MN County - Itasca North"
- "MN County - Itasca South"
- "MN County - Jackson"
- "MN County - Kanabec"
- "MN County - Kandiyohi"
- "MN County - Kittson"
- "MN County - Koochiching"
- "MN County - Lac Qui Parle"

- "MN County - Lake of the Woods North"
- "MN County - Lake of the Woods South"
- "MN County - Le Sueur"
- "MN County - Lincoln"
- "MN County - Lyon"
- "MN County - Mahnomen"
- "MN County - Marshall"
- "MN County - Martin"
- "MN County - McLeod"
- "MN County - Meeker"
- "MN County - Morrison"
- "MN County - Mower"
- "MN County - Murray"
- "MN County - Nicollet"
- "MN County - Nobles"
- "MN County - Norman"
- "MN County - Olmsted"
- "MN County - Ottertail"
- "MN County - Pennington"
- "MN County - Pine"
- "MN County - Pipestone"
- "MN County - Polk"
- "MN County - Pope"
- "MN County - Ramsey"
- "MN County - Red Lake"
- "MN County - Redwood"
- "MN County - Renville"
- "MN County - Rice"
- "MN County - Rock"
- "MN County - Roseau"
- "MN County - Scott"
- "MN County - Sherburne"
- "MN County - Sibley"
- "MN County - St Louis Central"
- "MN County - St Louis North"
- "MN County - St Louis South"
- "MN County - Stearns"
- "MN County - Steele"
- "MN County - Stevens"
- "MN County - Swift"
- "MN County - Todd"
- "MN County - Traverse"

- "MN County - Wabasha"
- "MN County - Wadena"
- "MN County - Waseca"
- "MN County - Watonwan"
- "MN County - Winona"
- "MN County - Wright"
- "MN County - Yellow Medicine"
- "Modified Airy"
- "Modified Everest 1948"
- "Modified Mercury 1968"
- "South America 1969"
- "Southeast Asia"
- "Sphere Radius 6356752 m"
- "Sphere Radius 6370997 m"
- "Sphere Radius 6371000 m"
- "Sphere Radius 6371007.181 m"
- "Sphere Radius 6371204 m"
- "Sphere Radius 6378137 m"
- "Sphere Radius 6378388 m"
- "War Office (McCaw 1924)"
- "WGS66"
- "WGS72"
- "WGS84"
- "WI County - Burnett"
- "WI County - Chippewa"
- "WI County - Douglas"
- "WI County - Marathon"
- "WI County - Sheboygan"
- "WI County - Taylor"
- "Xian 1980"

- *Datum Transformation Method*: This section consists of four radio button options:
 - *3-parameter (Molodensky) Transformation*: Uses the Molodensky transformation method.
 - *7-parameter (Bursa-Wolfe) Transformation (Position Vector Rotation)*: Uses [seven parameters](#): "three translations, three rotations, and a scale correction factor".
 - *7-parameter (Bursa-Wolfe) Transformation (Coordinate Frame Rotation)*:

Variation of the above.

- *Custom Shift Based on Control Point File*: Selecting this options brings up an *Open* dialog which allows choosing a Control Point File with the necessary data to set the datum transformation method. This file is a text file with entries (one per line) in the following format:

```
deg_longitude_in_new_datum,deg_latitude_in_new_datum,deg_longitude_in_WGS84,de
```

- *Shifts to WGS84 (meters)*: This section allows the *X Shift*, *Y Shift*, and *Z Shift* to be manually set for the new datum.
- *Rotation to WGS84*: This section allows setting the X, Y, and Z in for the new datum by selecting from the *Units* drop-down:
 - arc-seconds
 - radians
 - micro-radians
- *Scale Correction to WGS84 (parts per million)*: This section allows setting the *Scale (ppm)* for the new datum.

Planar Units

The planar unit is simply the measuring format used in the projection. Select the appropriate one from the list.

List of Planar Units

- "Meters"
- "Feet (U.S. Survey)"
- "Feet (International)"
- "Nautical Miles"
- "Yards"
- ["Indian Yards"](#)
- ["Clarke's Feet"](#)
- "Cape Feet"
- "Inches"
- "Links"
- ["Chains \(Benoit\)"](#)
- "Chains (Sears)"
- ["Clarke's Links"](#)
- "Centimeters"
- "Millimeters"
- "Kilometers"
- ["British Chains \(Sears 1922 Truncated\)"](#)
- ["Clarke's Yards"](#)
- ["German Legal Meters"](#)
- ["Gold Coast Feet"](#)
- "Sears Yards"
- "Sears Feet"

Parameters

In the *Parameters* section, the *Attribute* and *Value* columns contain information specific to the *Projection* and *Zone* selected.

Related Topics

- [Projections](#)

CPP Coordinate System

A CPP (Carte Parallelo-Grammatique Projection) system is a local system. The origin of the system must be defined in latitude/longitude decimal degrees.

The conversion from of a point from latitude/longitude to CPP is:

$$\text{newpoint}_x = R * \left(\text{point}_{\text{longitude}} - \text{origin}_{\text{longitude}} \right) * \cos \left(\text{origin}_{\text{latitude}} \right)$$

$$\text{newpoint}_y = \text{point}_{\text{longitude}} * R$$

The conversion of a point from CPP to latitude/longitude is:

$$\text{newpoint}_{\text{longitude}} = \frac{\text{origin}_{\text{longitude}} + \text{point}_x}{R * \cos \left(\text{origin}_{\text{latitude}} \right)}$$

$$\text{newpoint}_{\text{latitude}} = \frac{\text{point}_y}{R}$$

$R = 6378206.4m$. (Clarke 1866 major spheroid radius)

See also

- [Coordinate Systems](#)
- [Projections](#)
- [Projection Dialogs](#)

Geographic Coordinate System

A Geographic system is a latitude/longitude system defined in decimal degrees. Supported Geographic systems include:

- NAD (North American Datum) 1927 and NAD 1988
- 33 world ellipsoids and a user defined ellipsoid (i.e., Clarke 1866, WGS 1984, etc.)

The hemispheres are defined for non-NAD systems. The hemisphere cannot be changed for NAD systems (Northern, Western hemispheres).

Related Topics

- [Projections](#)
- [Projection Dialogs](#)

Local Coordinate System

A local coordinate system is a system defined for a survey. Many numerical models work in local systems, and don't care how that system relates back to global coordinate systems (UTM, State Plane etc.). If a portion of the data for a project is referenced to a global coordinate system, and a portion is in a local system, a transformation to convert all the data to a single system must be defined. This can be done by defining the location and orientation of the origin of the local system with reference to the global system. This allows the data to be referenced back to the global system or to another local system.

Three scenarios are possible when dealing with local coordinate systems:

1. Global to Local – When converting from a global to a local coordinate system, the global coordinates of the origin of the local coordinate system must be defined using the **Local Origin** button in the lower portion of the dialog. This dialog can also be used to enter the angle of rotation of the local coordinate axes relative to the global coordinate axes. The angle is measured ccw from the positive x-axis.
2. Local to Local – When converting from one local coordinate system to another local coordinate system, the same approach is used as when converting from a global to local coordinate system. The *Local Origin* dialog is used to define the coordinates of the origin of the new coordinate system relative to the old coordinate system.
3. Local to Global – When converting from a local to a global coordinate system, the Local Origin dialog is used to coordinates of the local coordinate system (which is the old system in this case) relative to the new global coordinate system.

See also

- [Coordinate Systems](#)

Transform

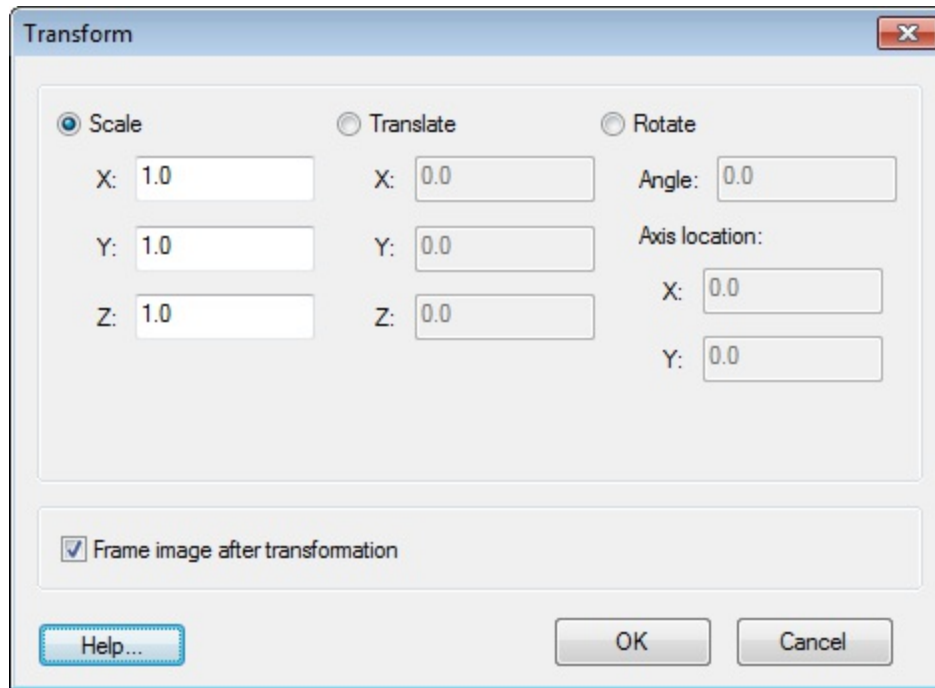

Transform dialog

The **Transform** command, in the *Edit* menu or the right-click menu of many data objects in the Project Explorer, is used to move objects. In the *Transform* dialog, the transformation type can be chosen and then appropriate parameters can be entered. The following transformation types are available:

- **Scaling:** Scaling factors for the X, Y, and/or Z directions are entered. To prevent scaling a specific direction, the default value of 1.0 should be used.
- **Translation:** Translation values for the X, Y, and/or Z directions are entered. To prevent translation in a specific direction, the default value of 0.0 should be used.
- **Rotations:** When rotation is selected, the set of options on the right side of the dialog become available to define the center of rotation around the Z axis. The rotation will occur counter-clockwise by the specified angle around the specified center of rotation.

By default, the image will be framed after the transformation takes place. However, this can

be turned off by using the *Frame image after transformation* option.

See Also

- [Coordinate Transformation](#)
- [Edit Menu](#)

3.3. The Display Menu

Display Menu

The *Display* menu is one of the standard menus and is available in all of the modules. The commands in the *Display* menu are as follows:

Display Options

Opens the *Display Options* dialog.

Contour Options

Opens the *Contour Options* dialog.

Refresh Display

Clears and redraws the Graphics Window.

Redraw Display

A more thorough version of **Refresh Display**, forces the regeneration of the display from the project data. Items are redrawn at the size specified in the *Display Options*.

Frame Image

Adjusts the view so that all currently visible objects fit in the *Graphics Window*.

Map Locator

Used to navigate to any place on Earth. The Graphics Window is positioned to the location shown in the *Map Locator* and the display projection is set to a global projection if not already in one.

Display Projection...

Sets the projection used for the display.

Visibility

A submenu for the **Hide**, **Show** and **Isolate** commands. These commands only act on the graphics objects associated with the current selection tool. If the current tool is not a selection tool, these commands are not available.

Hide

Causes the selected objects to become invisible.

Show

Causes hidden objects to become visible.

Isolate

Hides all but the selected objects.

View

A submenu with commands for altering the view in the Graphics Window.

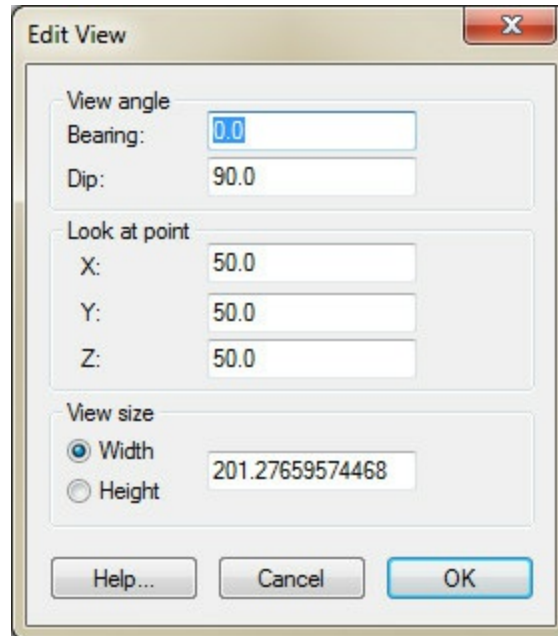

Example of the Edit Angle dialog.

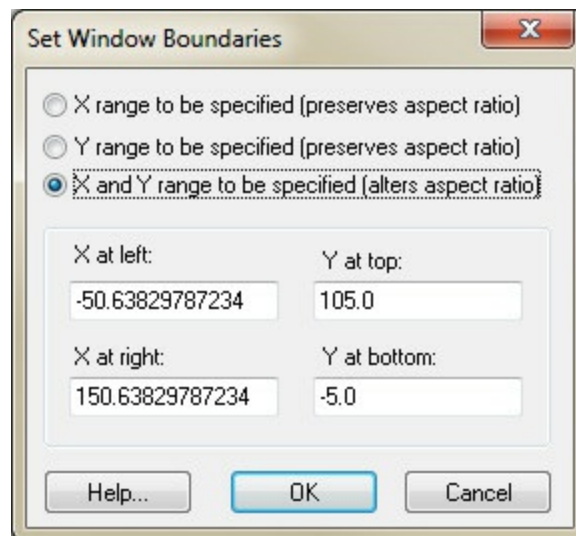

Example of the Set Window Boundaries dialog.

View Angle

Opens the *Edit View* dialog. In this dialog the bearing and dip angles can be explicitly defined. The objects in the [Graphics Window](#) can be rotated and viewed in three dimensions. Two angles, bearing and dip, are used to rotate the view. The bearing and dip values correspond to a rotation about the z and x axes. The bearing affects the horizontal angle (rotating the object in the xy plane), and the dip changes the vertical angle (shifting the viewing angle on the object to a higher or lower perspective). The object cannot be tilted sideways. Using only two viewing angles rather than three limits the viewing angles, but it is simpler. Alternatively, the viewing angles can be manipulated interactively with the [Rotate](#) tool.

Window Bounds

The region of the real world coordinate system that is mapped to the [Graphics Window](#) can be altered using the [Pan](#) and [Zoom](#) tools. It is also possible to precisely control the visible region by selecting the **Set Window Bounds** command from the *View* menu. This command brings up the *Set Window Boundaries* dialog. If the *X range to be specified (preserves aspect ratio)* option is selected, the x coordinate at the left and right and the y coordinate at the bottom of the Graphics Window are specified. The y coordinate at the top of the Graphics Window is not specified in order to maintain the aspect ratio. If the *Y range to be specified (preserves aspect ratio)* option is selected, the y coordinate at the top and bottom and the x coordinate at the left of the Graphics Window are specified. The x coordinate at the right of the Graphics Window is not specified in order to maintain the aspect ratio. If the *X and Y range to be specified (alters aspect ratio)* option is selected, the x coordinate at the right and left and y coordinate at the top and bottom of the Graphics Window are specified. Since all four coordinates are specified, the aspect ratio of the scene may be altered.

Plan View

Changes the viewing angle to look down the z-axis with the x-axis horizontal and the y-axis vertical.

Front View

Changes the viewing angle to look down the y-axis with the x-axis horizontal and the z-axis vertical.

Side View

Changes the viewing angle to look down the x-axis with the y-axis horizontal and the z-axis vertical.

Oblique View

Changes the viewing angle to look at the model at an angle of 45° to each axis.

Previous

Restores the [Graphics Window](#) viewing parameters as they were before the last viewing command was issued (rotate, zoom, pan, etc.). Views are automatically saved in a list so continued use of this command will continue to restore previous views.

General/Ortho Mode

A command is provided in the *Display* menu for switching between the orthogonal and general viewing modes. The orthogonal mode is only available with [3D grids](#).

Convert To Cad

Exports any visible geometric data to a CAD file. This command can also be found by right-clicking in the empty space in the [Project Explorer](#).

Toolbars

The *Toolbars* submenu allows hiding and showing the listed toolbars.

Plot Wizard

Brings up the *Plot Wizard* dialog.

Animate

The **Animate** command launches the [Animation Wizard](#).

Play Animation

The **Play Animation** command launches an AVI player that allows browsing for an AVI file and play the animation.

Related Topics

- [GMS Menus](#)

Contour Options

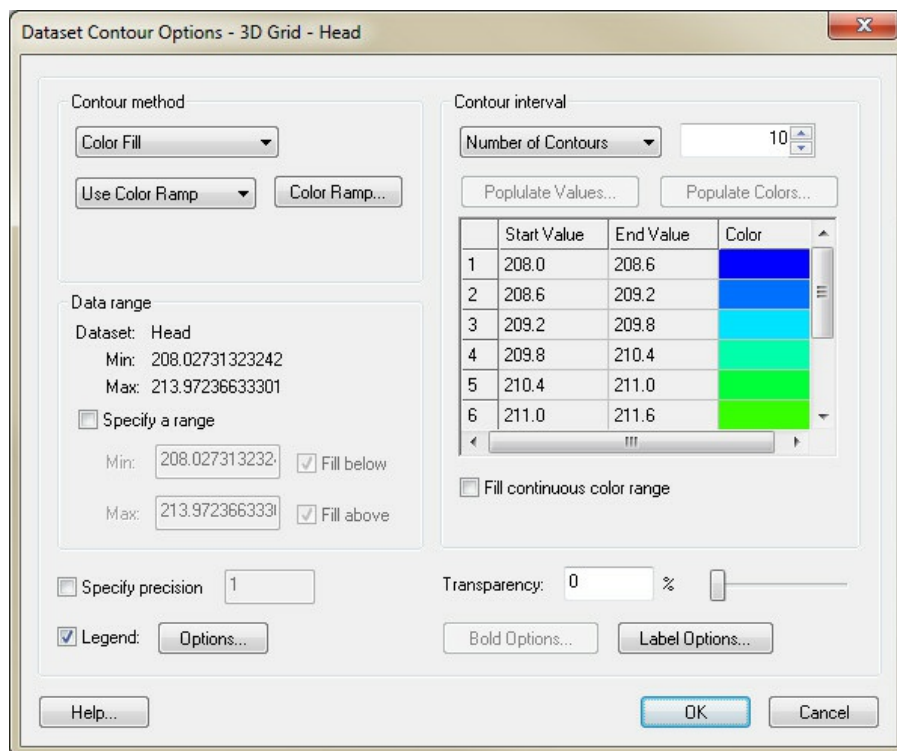

Example of the Contour Options dialog. Options may vary depending on the active dataset.

The options used to generate contours can be edited by selecting the **Contour Options** command in the *Display* menu. The items in the *Contour Options* dialog are as follows:

General vs. Grid Layers

There are two tabs associated with the *Contour Options* dialog. The options described below are for the General options. The [Grid Layers options](#) are used when contouring 3D grids.

Contour Method

There are 3 main types of contours: linear, color filled, and both linear and color filled.

Linear – The default method is Normal linear contours and causes the contours to be displayed as piece-wise linear strings.

Color Fill – If the Color fill between contours option is selected, the region between adjacent contour lines is filled with a solid color. There is also a smooth option available. When this option is turned on the color between contour lines varies according to the color ramp. The transparency of the filled contours can also be adjusted.

Linear and Color Fill – This option shows linear contours on top of color filled contours.

Block Fill - This option applies only to cell centered grids. Cells are filled with a single color. The color chosen corresponds to the color ramp value associated with the value at the cell center.

Line options

Bold contours – *The Bold every...* option can be used to display contours at selected intervals with a thicker line width.

Contour labels – *The Label every...* option can be used to plot labels on contours at selected intervals. The contour label options are edited using the Contour Labels dialog.

Data Range

The values shown in the Data range section correspond to the maximum and minimum values in the active dataset. These values are sometimes useful when choosing an appropriate contour interval.

Use each timestep's max and min – This option is only applicable if contours are colored according to a color ramp, and the dataset has more than one time step. If this option is on, the maximum and minimum color ramp colors will be displayed for every timestep. Otherwise, the maximum and minimum colors apply to the entire dataset and therefore will only appear when the current dataset contains the dataset maximum or minimum value.

Contour Specified Range – Regardless of which option is selected for the contour interval, a maximum and a minimum contour value can be specified and the contouring can be restricted to the specified range. If desired, the fill below or fill above options can be turned on to color fill above/below the specified range.

Contour Interval

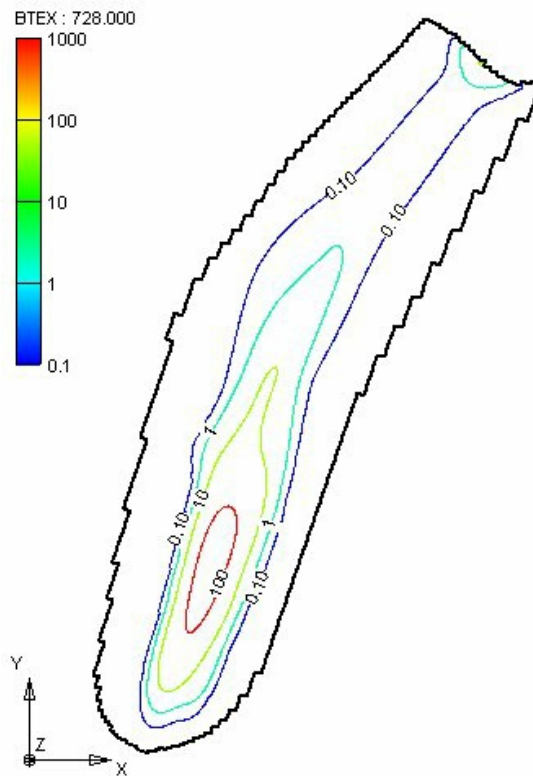

Example of contour interval lines.

The contour interval defines the values associated with the contours. Based on the option selected, the contour values are computed and displayed in the spreadsheet. The colors of the contours will also be displayed if a [Color Ramp](#) is being used.

Four options are provided for defining contour intervals in the Contour Options dialog. The options are as follows:

Number of Contours – With the Number of Contours option, an integer is entered representing the total number of contours. The contour interval is adjusted based on the current active dataset so that the contours are evenly spaced and the number of contours correspond exactly to the specified value.

Specified Interval – Directly specifies the contour interval (5, 10, 20, etc.).

Specified Values – Allows entering a list specific contour values. Contours are only generated at these values.

Log Interval – When contouring chemical data, it is common to have a small "hot spot" somewhere in the interior of the grid where the concentrations are several orders of

magnitude higher than the rest of the grid. In such cases, the contours are all biased to the high concentration zones and no contours are drawn in the low concentration zones. A common approach for dealing with such situations is to select a set of contour values corresponding to multiples of ten (0.01, 0.1, 1.0 10.0, etc.). This can be accomplished by explicitly assigning a set of contour intervals using the Specified Values option. The problem with this approach is that the colors assigned to the contours are still based on a linear interpolation of the data values, thus skewing the colors to the higher concentration zones.

If the Log Interval option is selected, GMS automatically assigns contour intervals as multiples of 10. Furthermore, if the color-fill or color ramp option is being used, the colors assigned to the contours are distributed in a logarithmic fashion, rather than linearly interpolated from the low to high values. A sample plot using logarithmic contour intervals is shown below:

If the Log interval option is selected, all contour intervals will be positive. No contours are drawn in areas where the data values are zero or negative. Furthermore, a "Starting value" must be entered. This value represents the minimum contour value.

Contour Labels

The **Label Options** button in the *Contour Options* dialog is used to access the *Contour Label Options* dialog. This dialog is used to set the label color, the number of decimal places used to plot the label, and the spacing used when the labels are generated automatically. The default spacing value controls the placement of labels when labels are generated automatically.

Labels can be added to contours in one of two ways:

1. If the contour label option is selected in the *Contour Options* dialog, labels are automatically placed on the contours. The spacing of the labels is controlled with the *Contour Labels* dialog.
2. In some modules, contour labels can be added manually to contours by selecting the **Contour Labels** tool in the Tool Palette and clicking on the contours where labels are desired. By default, the dataset value corresponding to the point that was clicked is

computed and a label corresponding to the nearest contour value is drawn centered at the point that was clicked. An option can be set in the *Contour Label Options* dialog to use the exact value at the point that is clicked as opposed to using the nearest contour value. This option is useful to post dataset value labels in regions where there are no contours.

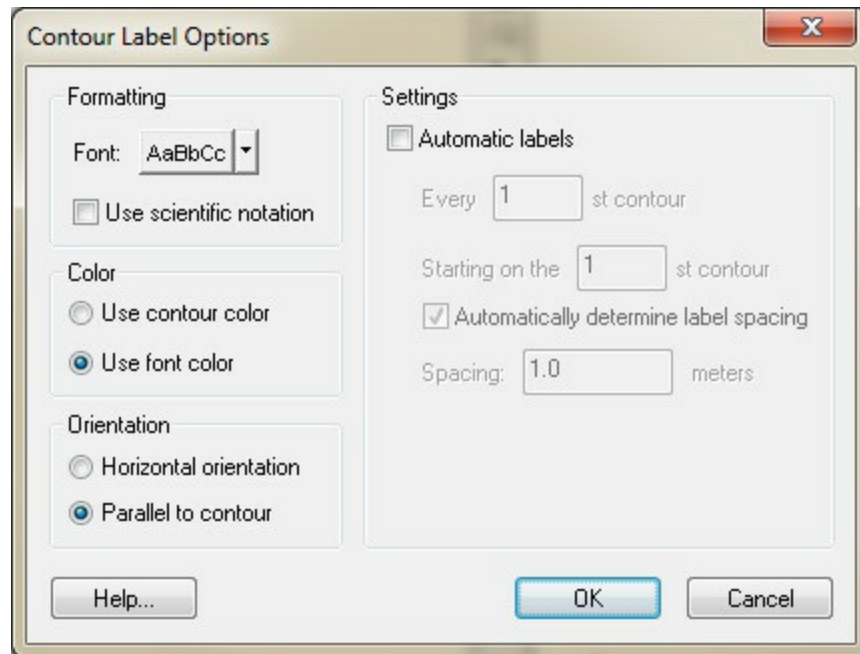

Example of the Contour Label Options dialog.

Specified Dataset

Specify the dataset with the **Select Dataset...** button in the *3D Grid Data* tab of the *Display Options* dialog. This brings up a new window where the specified dataset is selected. The contour options available for the specified dataset are the same as the active dataset options, yet each must be established separately. This option is useful in comparing datasets.

Grid Layer Contour Options

When contouring 3D grid data, there are additional options available in the *Contour Options* dialog. These options let you choose the data to contour. The default array used to fill cells is the active dataset. Another option for filling cells is the data colors option; this uses an input

array from MODFLOW, MODPATH, MT3DMS, SEAM3D, or RT3D. Any of the input arrays from the models such as Kh, Kv, Recharge, etc. can be displayed, for any stress period. For MT3DMS/RT3D/SEAM3D, also specify the species.

Interpolation

GMS interpolates data from the cell centers (for cell-centered grids) to the cell corners and midsides so that the grid can be triangulated and contoured. By default, GMS uses a fast algorithm for interpolating the data that is adequate for the majority of situations. If the **Auto-interpolate contours** option is turned off, specify a customized interpolation scheme. By default, GMS truncates the interpolated values to the max and min of the data, but the option can be turned off.

Animations

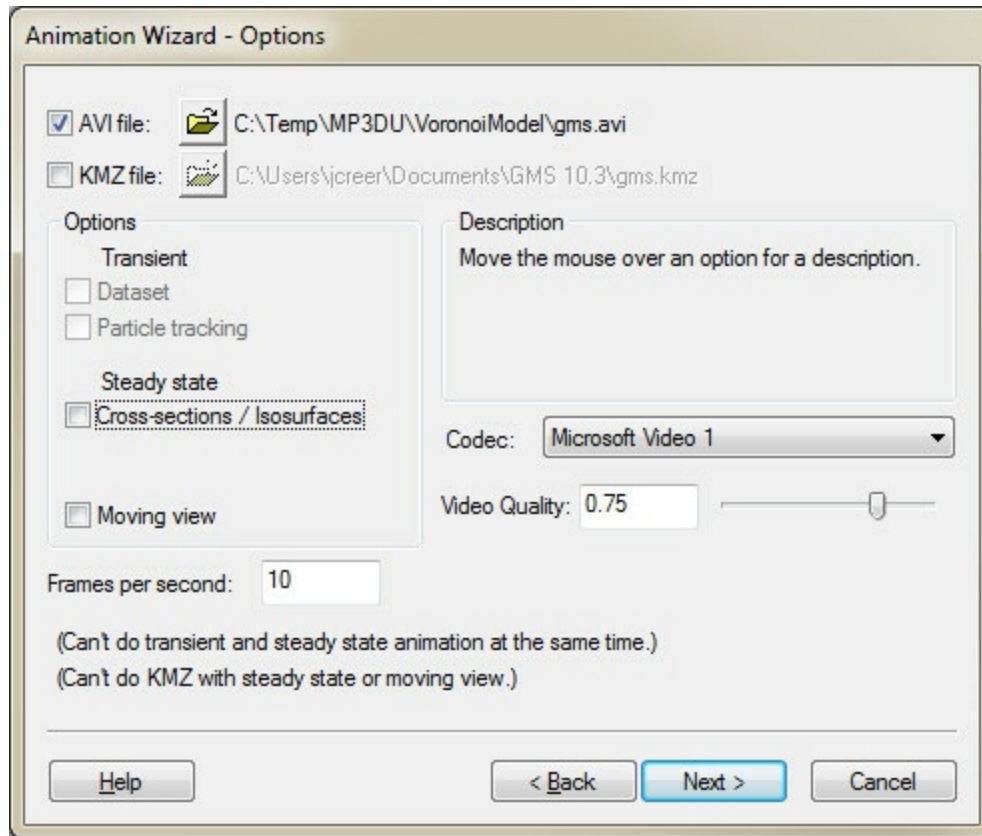

Example of the Animation Wizard – Options dialog.

One of the most powerful visualization tools in GMS is animation. Animations can be created with transient or steady state data. The view angle and zoom factor can be changed during the animation as well. Animations are saved in the Windows (*.avi) format. AVI files can be played back externally to GMS using a variety of applications and can be inserted into multi-media documents and applications.

A new animation can be created by selecting the **Animate** command from the *Display* menu.

The animation tools are included with all [editions](#) of GMS, including the community version.

Animation Options

There are multiple options available when creating an animation:

Option	Type
Dataset	Transient
Particle Tracking	Transient
Cross-sections / Isosurfaces	Steady State
Moving View	N/A

Transient vs. Steady State Animation

All of the options except *Moving view* are either considered Transient or Steady state. GMS does not allow use of a *Transient* option and a *Steady State* option at the same time. Moving view, however, can be used by itself or in conjunction with any combination of the other options.

The typical case for choosing to do a transient animation is when a projects has a transient solution generated by a model. The transient animation could illustrate how vectors, contours, fringes or isosurfaces change at different solution times. A transient animation can also be used to show particle tracking over time, even with a steady state solution.

Steady state animation can only be performed using 3D grids or 3D meshes. A steady state animation can be used with a steady state dataset, or with one time step of a transient dataset. Two options are available for steady state animation: Cross-section / isosurface animation and flow trace animation.

Dataset Animation

Transient dataset animation can be used with any object with a transient dataset. As each frame is generated, a set of values corresponding to the current time is loaded into memory and the image is redrawn using the current display options. Thus, if the *contour display* option is selected, the contours will vary from frame to frame according to the changes in the dataset.

The total number of frames generated in the animation can be defined by either matching the time steps (one frame per time step) or by using a constant interval (e.g., one frame for every two hour interval). If the Match time steps option is chosen, extra frames can be created between each time step if necessary using linear interpolation of the data values at the specified time steps.

Particle Tracking Animation

Particle tracking can be animated to show how pathlines grow over time. Although it is considered a *Transient* option in the table above, this option can be used with a transient or a steady state solution. Only the forward tracking particle sets can be animated.

If *Particle tracking* is selected by itself, choose how many frames are wanted in the animation. GMS will then compute the time at which to generate each frame by dividing the total animation time evenly by the number of frames. The animation begins at the minimum start time of all forward tracking particle sets, and ends at the maximum travel time of all particles (in all forward tracking particle sets).

Cross-section / Isosurface Animation

If the *Geometric surface animation* option is chosen, a cutting plane and/or an isosurface can be animated. If the *Animate cutting plane over specified XYZ range* option is chosen, an x, y, and/or z cutting plane is incrementally moved through the mesh or grid from the specified beginning location to the ending location as each frame is generated. This generates an animation showing a moving cross section. If the *Animate isosurface* option is chosen, a single isovalue is incrementally varied between the specified beginning and ending values and a different isosurface is generated for each frame based on the value.

Moving View

The *Moving View* option can be used by itself or in conjunction with any combination of the other options. This option can be used to change how to view the data as the animation proceeds. Define views and associate them with particular frames of the animation. When the animation is generated, GMS will interpolate between the defined views to determine what the view should be at every frame.

Flow Trace Animation

If the *Animate flow trace* option is chosen, a flow trace animation of the steady state vector data on 3D grid or 3D mesh cross sections is generated. Flow trace animation is a special type of animation that is similar to particle tracking. A series of particles is randomly generated on the cross sections and it is traced through time. Each particle has a limited

life span. As a result, the particles appear as a series of streaks. Flow trace animation can result in highly intuitive images of a vector field.

If there is no vector dataset or cross section associated with the current 3D grid or 3D mesh, the *Animate flow trace* option and *Flow trace* options button are dimmed. The *Animate flow trace* option is also dimmed if the *Flow trace* option is not selected in the *Cross Section Options* dialog. If the active vector dataset is transient, only the current time step is used to generate the flow trace animation.

The *Avg. number of particles per triangle* edit field specifies the density of particles to be generated in the animation. The *Decay ratio* specifies the amount of time necessary for a particle path to decay as it passes points in the cross section. The *Velocity magnitude limit* and *Velocity direction limit* specify the distance that a particle will travel between consecutive frames.

CODEC

Starting in GMS 6.5 choose which codec to use to create an AVI movie. GMS will search the computer for all compatible codecs and they will be available in the pull down menu.

Animation Playback

Once a new animation has been generated, GMS launches the [AVI player](#) and plays the animation. The speed of playback can be adjusted using the *Speed* scroll bar. The maximum speed depends on the speed of the computer and the size of the image being animated. The smaller the image, the faster the maximum playback speed.

Color Ramp

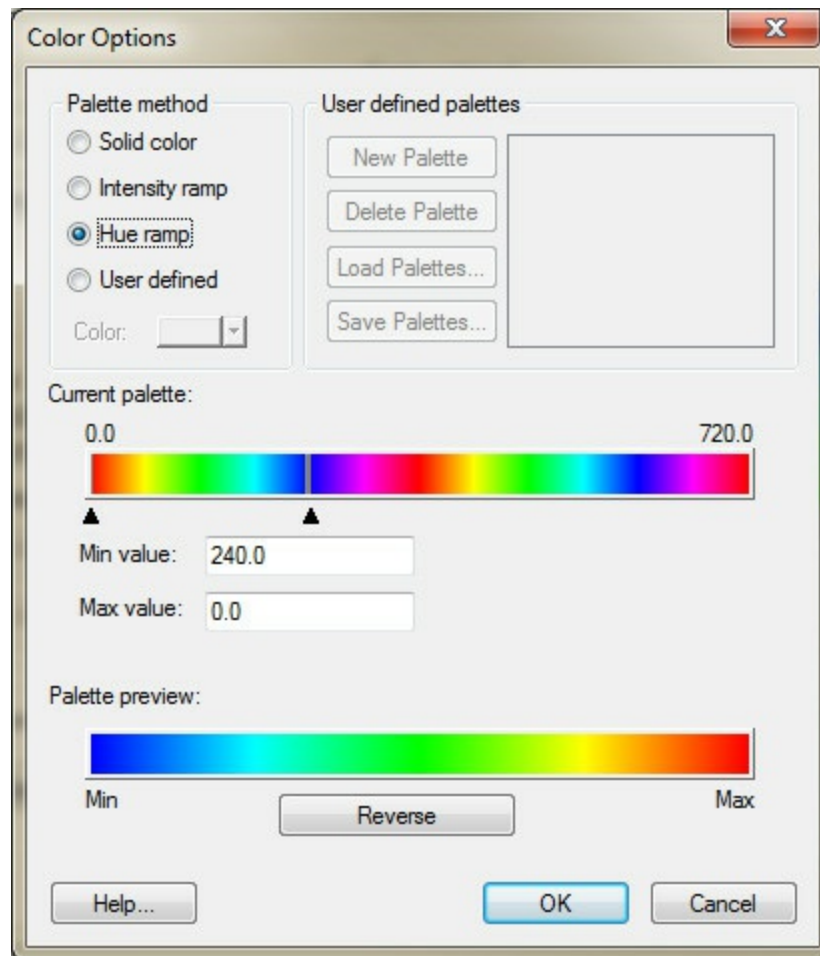

An example of the Color Options dialog.

Several of the display options (contours, isosurfaces, color-shaded vectors, etc.) use a color ramp to vary the display color based on a relative value. The color ramp can be edited by selecting the **Color Ramp** command in the *Contour Options* dialog. The *Color Options* dialog contains the following options:

Legend

If the *Legend* option is selected, a vertical strip of colors with a legend of corresponding dataset values is displayed in the upper left corner of the *Graphics Window* whenever the color ramp is used to display an object (shading, color contours, etc.). The length and width of the color legend are specified with the *Legend width* and *Legend height* edit fields. The

values entered for legend width and height are in screen pixels.

Palette Method

The *Palette Method* section lists the three basic options for defining the color ramp:

Intensity Ramp

The *Intensity Ramp* option defines a ramp of colors corresponding to a varying intensities of a single color.

Hue Ramp

The *Hue Ramp* option defines a ramp of color hues (red-yellow-green-blue-magenta) at the maximum color intensity.

User-Defined

If the *User-Defined* option is selected, a user-defined color palette is used to define the color ramp.

User-Defined Palettes

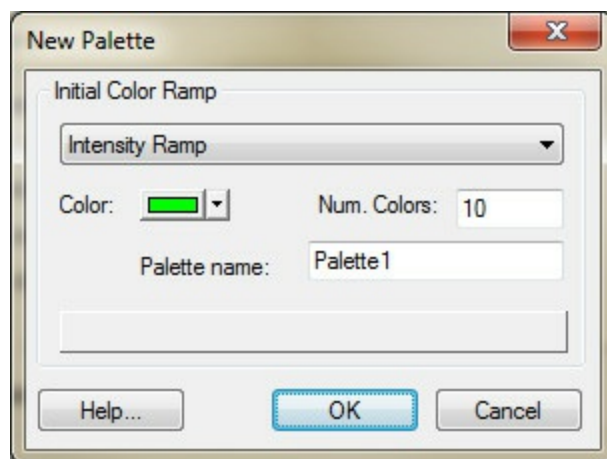

An example of the New Palatte dialog.

The user-defined color palettes are listed in the upper right corner of the *Color Ramp Options* dialog. A new palette is created by selecting the **New** button. This button brings up the *New Palette* dialog listing a set of options for defining the initial color palette. These colors can be edited using the *Current Palette* section of the *Color Ramp Options* dialog.

An existing palette can be deleted using the Delete button.

Once a set of user-defined color palettes are created, they are saved with the project to a palette file (*.pal). The **Import** and **Export** buttons can be used to share user-defined palettes between projects.

Current Palette

The current color palette is displayed in the *Current Palette* section. The min and max value of the color ramp can be set by clicking and dragging the two triangles just below the color palette. For user-defined color palettes, new colors can be added, colors can be deleted, and the color associated with a color entry can be edited using the tools just below the palette.

The data value associated with a selected color can be edited either by dragging the color or by entering a new value directly. The values can be displayed as either percentages or direct values (corresponding to the active dataset). The **Edit Table** button can be used to edit the colors and corresponding values directly in a tabular format.

Preview

The *Preview* section at the bottom of the *Color Options* dialog displays the color ramp defined by the current palette and max and min values. The **Reverse** button can be used to reverse the direction of the color ramp (for example, to switch from red-yellow-green-blue to blue-green-yellow-red).

See also

- [Contour Options](#)

















3.3.1. Display Options

Display Options

Most of the data types in GMS have a set of display options that can be modified using the **Display Options** command in the *Display* menu. The **Display Options** command brings up the *Display Options* dialog. The dialog can also be brought up using the **Display Options**  macro.

Data Type Tabs

The *Display Options* dialog contains a list of the data objects currently in memory. Corresponding data tabs are displayed in the dialog depending on what object type is selected in the list box. Each display feature associated with a data type is listed in the *Display Options* dialog. The check box next to the feature named can be toggled on or off to control whether or not the feature is to be displayed. In addition, the button next to the feature brings up a dialog that can be used to edit the display attributes of the feature (color, font, line thickness, etc.). The following table describes the display options tabs that exist for the various data types. Click on the links to learn more about the specific display options for each data type.

Image	Data Type	Tabs Also Available for Data Type
	TIN Data	
	Borehole Data	
	Solid Data	
	2D Mesh Data	SEEP2D
	2D Grid Data	
	2D Scatter Data	
	3D Mesh Data	FEMWATER , Particles , ADH
	3D Grid Data	MODFLOW , Particles , MT3D
	3D Scatter Data	
	Map Data	MODAEM , UTEXAS
	Ugrid Data	MODFLOW , Particles
	GIS Data	
	Cross Sections	
	Materials	
	Lighting Options	
	Axes	
	Drawing Grid	

General Display Options

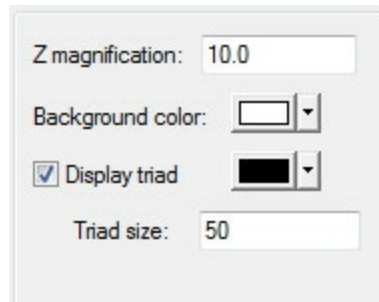

Example of the General Options in the Display Options dialog.



The *Display Options* dialog also controls several general display options in GMS. These general display options are described below.

- *Z magnification* – Occasionally an object may be very long and wide with respect to its overall depth (z dimension). In such cases, it is possible to exaggerate the z scale so that the variation in the z value is more apparent by changing the magnification factor from the default value of 1.0.
- *Background color* – The *Color* dialog can be brought up to change the selected color. The selected color is displayed as the background color in the [Graphics Window](#).
- *Triad options* – To aide in visualization of 3D objects in oblique view, a XYZ triad can be displayed in the lower left corner of the [Graphics Window](#). The display, size, and color of the triad can be specified in the *Display Options* dialog. The triad is useful in visualizing how the geometry currently defined in GMS aligns with the world coordinate system.

See also

- [Display Menu](#)

Drawing Grid Options

When entering new nodes or entering a polygon or polyline in plan view, it is often useful to have the coordinates snap to a uniform grid. This allows accurate placement of the objects when the desired coordinates are even multiples of some number. The properties of the drawing grid can be controlled through the *Drawing Grid*  tab of the *Display Options* dialog. This dialog is accessed from the *Display* menu or the **Display Options**  macro. The following describes the display options available for the drawing grid.

- *Spacing* – This edit field specifies the spacing of the grid nodes and grid lines in the drawing grid. The *Grid color* window specifies the color that is used to display the drawing grid in the *Graphics Window*.
- *Snap* – If selected, all new vertices, nodes, points, etc., snap to the closest grid point as they are being created or when they are dragged interactively.
- *Display grid lines* – If selected, grid lines are displayed according to the *Line spacing increment*. For example, if the *Grid spacing* is set to 10 and the *Line spacing increment* is set to 5, a grid line will be drawn every 50 units. The grid line color can also be adjusted using the button next to the *Display grid lines* option.
- *Display grid points* – If selected, grid points are displayed according to the *Grid point spacing increment*. The grid point color can also be adjusted using the button next to the *Display grid points* option.

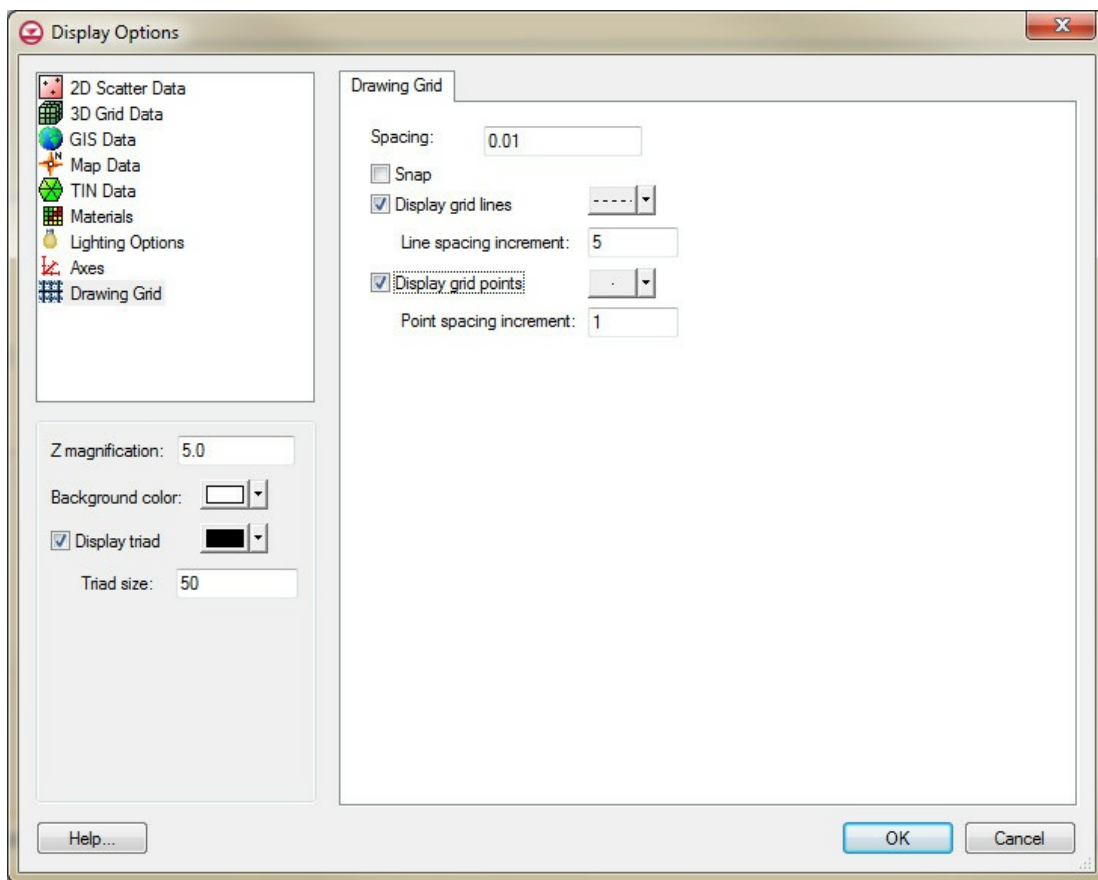

The Display Options dialog showing the Drawing Grid tab.

Related Topics

- [Display Options](#)

Vectors

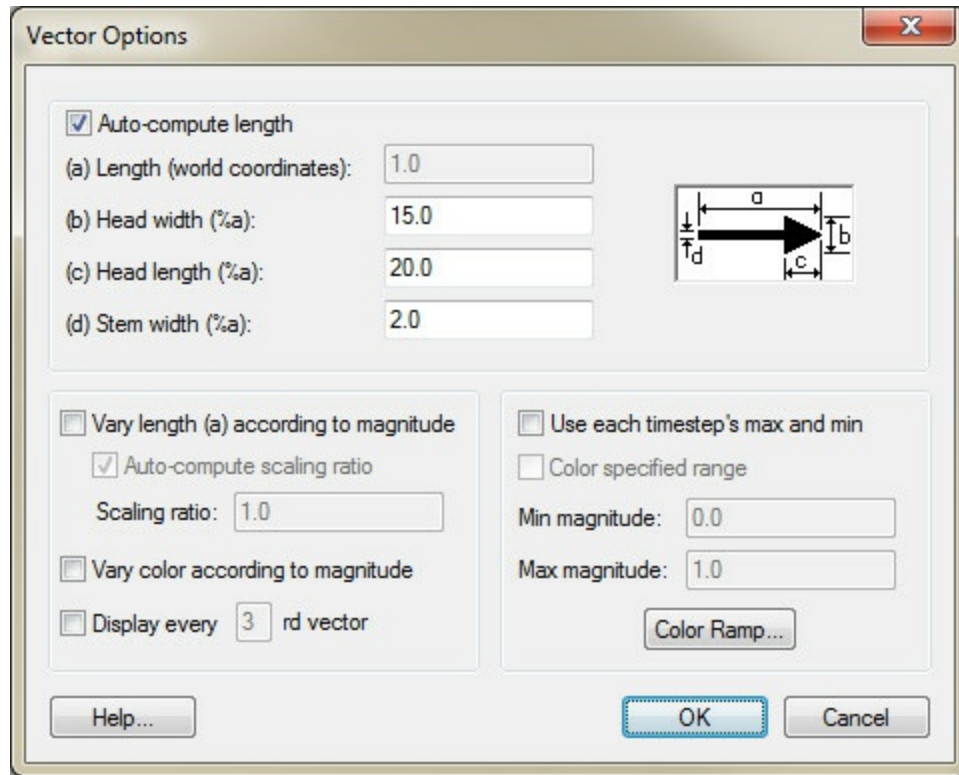

The Vector Options dialog.

If the *Vectors* item in the *Display Options* dialog is selected for an object (TIN, Grid, or Mesh), vector plots can be generated using the active vector dataset for the object. One vector is placed at each node, cell, or vertex.

The display of vectors can be controlled using the *Vector Options* dialog accessed through the **Vector Options** command in the *Data* menu or from a button in the *Display Options* dialog. The dialog options are as follows:

Dimensions

The *Auto compute length* option is on then GMS will compute the length of the vectors. If this option is off then the Length can be edited. The edit fields labeled *Length*, *Head width*, *Head length*, and *Stem width* control the size and shape of the vectors. The *Head width*,

Head length, and *Stem width* are expressed as a percentage of the length of the vector.

Vary Length and/or Color

Often it is desirable to vary the display of the vectors according to the magnitude of the vector function at a current point. This can be done with the *Vary length according to magnitude* and *Vary color according to magnitude*. If the *Vary length according to magnitude* option is selected each vector is displayed with a length equal to the magnitude of the vector multiplied by the *Scaling* ratio. If the *Vary color according to magnitude* option is selected, the vectors with the smallest and largest magnitude are drawn in the color of the lowest and highest colors on the current [color ramp](#). All other vectors are drawn in a color which corresponds to its magnitude from the current color ramp.

Display Every Nth Vector

If the *Display every _nth vector* is selected, only every nth vector is drawn. This is useful when the model is so large that drawing every vector clutters the display.

Color Specified Range

It is possible to have the current color ramp vary over a specified range of the active vector dataset. This is done by selecting the *Color specified range* option and editing the *Min magnitude* and *Max magnitude* edit fields.

2D vs. 3D Vectors

If in one of the orthogonal views (xy plane, xz plane, yz plane), the vectors will be displayed as 2D vectors. If in oblique view, the vectors are displayed as 3D vectors.

See also

- [Datasets](#)

- Display Options

Lighting Options

This dialog allows controlling the shading of faces in the SMS display. By default, all objects are displayed in the color specified by their attributes. However, objects such as elements, cells and triangles which cover an area, can be more intuitively understood if they are shaded as a three dimensional entity. The shading options includes two toggles, one slide bar and a light position window.

The lighting options are accessed by clicking on the **Lighting Options**  macro or *Lighting* tab in the *Display Options* dialog. The default options vary between applications, and the options may be changed, saved, and restored within the project.

Toggles

The first toggle allows turning on the use of a light source. When this toggle is selected, the second toggle becomes available. The second toggle tells SMS to smooth corners between adjacent faces. This allows the faceted surface to appear as a smooth surface.

Slider

The slide bar allows specifying the amount of ambient light. Ambient light is the minimum intensity (brightness) to be displayed. A recommended value is between 0.2 and 0.4.

Light Position

The right side of the dialog allows setting the light direction and gives a preview of that direction displayed on a sphere.

Enable lights Plan view: Drag to direct selected light.

Default
Scheme 2

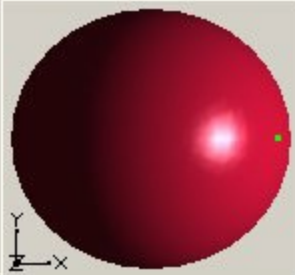

Surface attributes for all lights

Smooth edges Shiny: %

Intensity for selected light

Ambient: Diffuse: Specular:

Light	Enable	X	Y	Z	Ambient	Diffuse	Specular
1	<input checked="" type="checkbox"/>	0.806	0.0	0.441	20.0	100.0	99.0
2	<input type="checkbox"/>	0.5	-0.499	-0.542	58.0	100.0	100.0
3	<input type="checkbox"/>	0.0	0.0	1.0	0.0	40.0	40.0

The following table describes the lighting display options.

Display Option	Description
Enable lights	This check box controls whether light sources are used in the lighting process for generating lighted images. These light sources control the intensity of the colors on the lighted image and highlight the relief or geometrical variation in the surface of the objects being lighted.
Lighting list box	This list contains preset lighting schemes and highlights the scheme currently displayed.
Renaming a scheme	Double click on a scheme to begin editing its name.
Deleting a scheme	Right click on a scheme and select Delete. The final scheme cannot be deleted.
Creating a scheme	Right click on a scheme and select duplicate.
Plan view preview	This preview shows the current light scheme on a sphere in plan view, i.e., looking along the z-axis. Click or drag within the preview to direct both the diffuse and the specular components of the light currently selected in the light table. The selected light direction is shown by a dot on the sphere. A direction from in front of the sphere is shown by a green dot, and from in back by a red dot.
Smooth edges	Check this box to smooth all diffuse and specular lights of this scheme so that the surface does not appear faceted.
Shiny	Increase this value to sharpen all specular highlights of this scheme. At 100% this value turns off the specular highlight since it assumes that all specular lights are points whose reflection shrinks to a imperceptible point at maximum shininess. At 0% this value assumes that the full intensity of the light is reflected in all directions (decrease the specular values proportionally to get a realistic effect of less and less light reflecting to the eye from each surface).
Ambient slider	Shows the Ambient value of the light currently selected in the table, and can change the value. The ambient value is light from all directions which lights each and all surfaces uniformly leaving no surface unlighted. It is most useful on surfaces facing away from directional light such as diffuse and specular light.
Diffuse slider	Shows the Diffuse value of the light currently selected in the table, and can change the value. The diffuse value is for a point light which brightens surfaces in all directions the more they face the that light, and which leaves surfaces in darkness that face away from the light.
Specular slider	Shows the Specular value of the light currently selected in the table, and can change the value. The specular value is a point light which brightens surfaces if they reflect like a mirror from the direction of the light to the direction of the viewer, and which leaves surfaces in darkness that do not have this angle of reflection.
Light table	Displays the enable, xyz position, Ambient, Diffuse, and Specular values for each of 8 lights in the current scheme, and highlights the currently selected light. Any of these values may be modified by clicking them and editing their value.
Enable column	Check these boxes to turn on each light.
X, Y, and Z columns	Edit these values or click/drag in the plan view preview sphere to change the direction of the light. These values are will be normalized to a unit direction vector.
Ambient, Diffuse, and Specular columns	Edit these values or drag their corresponding slider.

Plot Axes

Version 9.2 and earlier

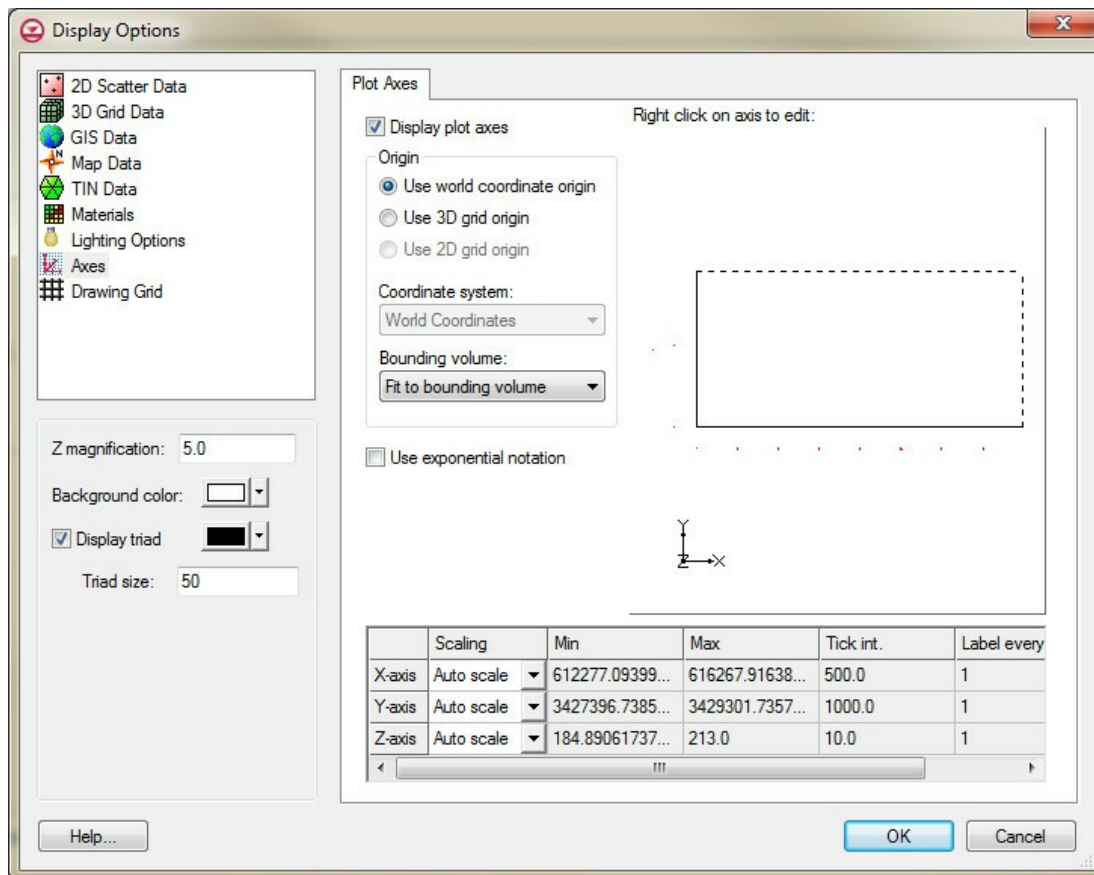

The Display Options dialog showing the Plot Axes tab in GMS 9.2 and earlier.

The Plot Axes are a set of ruled lines oriented in either the world coordinate system or the grid coordinate system. The axes can be either 2D or 3D. The properties the plot axes can be controlled through the *Plot Axes* tab of the *Display Options* dialog. The *Plot Axes* options are accessed by selecting the *Axes*  item in the *Display Options* dialog. The *Plot Axes* tab is then displayed on the dialog, and is used to specify the attributes of the axes, axes ticks, axes labels, and axes numbers. The following describes the display options available for the plot axes.

- *Display plot axes* – If selected, the plot axes will be displayed as specified and a

sample of the plot axes will appear in the window in the upper left of the dialog. If the *Display plot axes* toggle is not selected, all plot axes will be hidden and the rest of the dialog will be dimmed.

- *Origin options* – If selected, the numbers displayed on the plot axes are defined by the origin of the world coordinate system. If there is either a 2D or 3D grid currently defined in GMS, the origin of the grid can be used to define the numbering by selecting either the *Use 3D grid origin* option or the *Use 2D grid origin* option. If there is not a 3D grid defined in GMS, the *Use 3D grid origin* option is dimmed. Likewise, if there is not a 2D grid defined in GMS, the *Use 2D grid origin* option is dimmed.

If the world coordinate origin is used, the world coordinate system will also be used to align the axes. However, if the origin of either the currently defined 2D or 3D grid is used, the plot axes can be aligned with either the world coordinate system or the local grid coordinate system. If the angle of rotation of the currently defined grid is 0.00 degrees, there is no difference between the world coordinate system and the local grid coordinate system. If there is an angle of rotation other than 0.00 degrees, the local grid coordinate system can be used by selecting the *Local grid coordinates* option. The world coordinate system can be used by selecting the *World coordinates* option.

- *Use exponential notation* – This option controls whether or not the axes numbers are displayed using exponential notation.
- *Axis extents* – The extents of the plot axes are specified with the controls in the spreadsheet. The *Auto scale X*, *Auto scale Y*, and *Auto scale Z* options are used to specify that the extents and spacing of the axes will be automatically calculated by GMS. If extents or spacing other than the calculated defaults are desired, any or all of the **Manual scale X**, **Manual scale Y**, and **Manual scale Z** options can be selected. If one of the Manual scale options is chosen, the min, max, tick interval, and how many ticks are to be labeled are specified for the corresponding direction.

All of the directions that use the **Auto scale** option are further controlled by the *Fit to bounding volume* and the *Offset from bounding volume* options. If the *Fit to bounding volume* option is selected, the axes will be placed such that they fit tightly to the

bounding volume of the currently defined objects in GMS. If the *Offset from bounding volume* option is chosen, the axes will be placed such that they are 15-20% larger than the bounding volume of the currently defined object in GMS.

- *Axis properties* – The axis properties can be changed for each axis by right-clicking on the axis in the canvas window. The right-click menu options include *Hide axis* and *Edit Axis*. The *Edit Axis* options brings up a separate dialog with attributes including color and size that can be specified.

Version 10.0

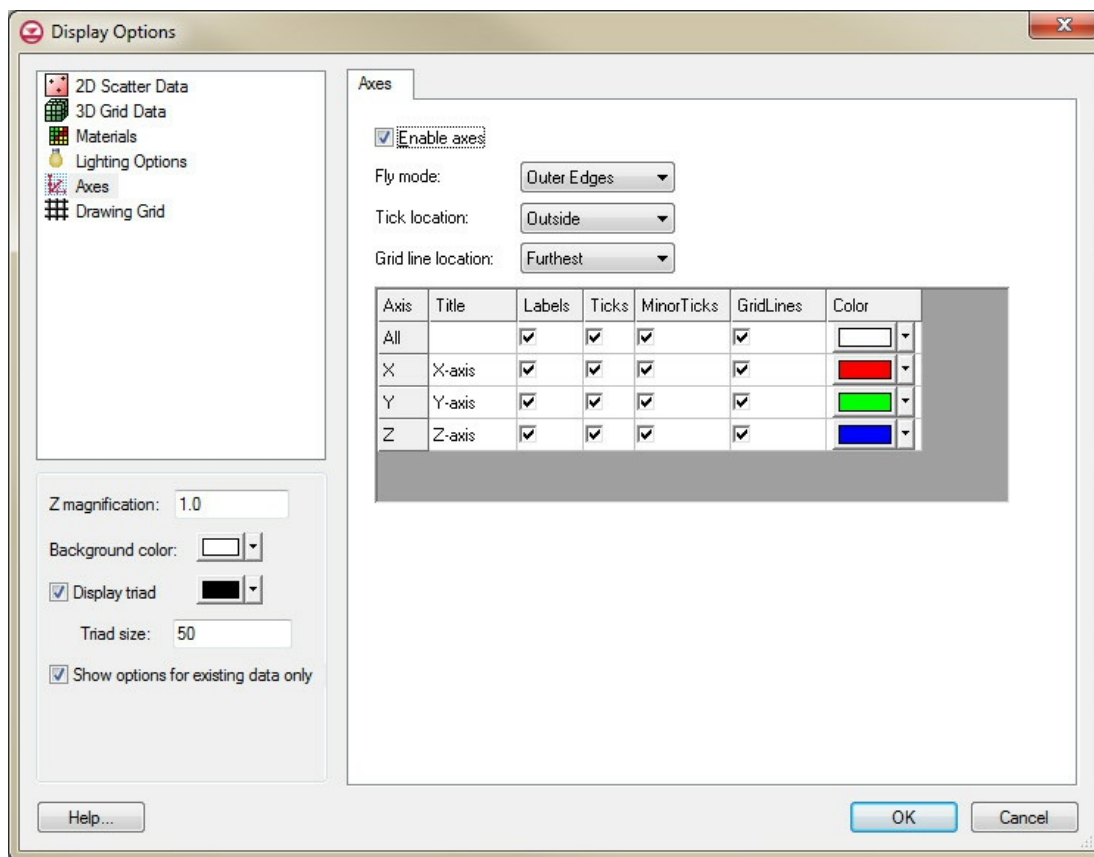

The Display Options dialog showing the Plot Axes tab in GMS 10.0 and later.

The Plot Axes are a set of ruled lines oriented in the world coordinate system. The plot axes options can be controlled through the *Plot Axes* tab of the *Display Options* dialog. The following describes the plot axes options.

- *Enable axes* – If on, the axes will be displayed.

- *Fly mode* – These options control where the axes are placed.
- *Tick location* – Controls whether tick lines placed along the axes are drawn inside or outside.
- *Grid line location* – These options control which surfaces grid lines are placed on.
- *XYZ Options* – For each axis, several options are available.

See also

- [Display Menu](#)
- [Display Options](#)

3.4. Other Tools

Annotations

Annotations can be added to a project to provide notes and clarification. The annotations application is included in all paid editions of [GMS](#) and [SMS](#).

Annotation Objects

The GMS and SMS applications contain tools to annotate the data in an application for presentations, animations and screen shots.



These tools (annotation objects) are accessed through the **Annotations**  module and include:

- Images
- North Arrows
- Scale Bars
- Text
- Lines
- Ovals
- Rectangles

Screen vs World Space Layers

All annotation layers either contain objects referenced to world or screen coordinates. Objects referenced to world coordinates will change size and position on the screen with the underlying data. This is useful to identify specific locations in the model such as pair locations. Objects associated with screen coordinates do not move on the screen with the underlying data. This is useful for titles, legends such as north arrows and scale bars, and

logos. Some types of annotations can only be created in screen space layers. These include North arrows, images, and scale bars.

When the first annotation object created, the program will ask which type of layer (screen or world space) to create and add the object to. Create additional layers by right-clicking on the "Annotation Data" item and selecting **Create Screen Space Layer** or **Create World Space Layer**. Layers are differentiated by their icons in the Project Explorer:  for screen space layers or  for world space layers.

If multiple layers exist, any newly created annotation object will be placed in the "current" layer.

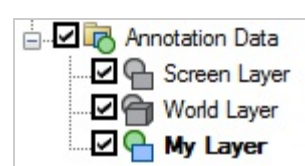

Annotation Object Attributes

The extents of annotation objects defined by a frame. Initially define this frame when creating the annotation object by clicking at any point on the screen and dragging a rectangle with the mouse (left button still down). The display will show the frame while dragging with the mouse. (Points and lines defining degenerate frames are not allowed.)

When creating a annotation, if the frame is too big for the window, it will be resized appropriately. Annotations can't be resized or moved even partially outside of the borders of the window. If, through a quick mouse drag, resizing a annotation causes the cursor to land outside the window, the annotation will be redrawn to take up all the window space in that direction.

This frame bounds the region of the screen where the object will appear with the modeling data. Interact with the object by interacting with its frame and specifying its attributes or properties (see the section on selection below). The frame anchors the annotation object on the screen. This anchoring defines both the size and position of the object. The x-location, y-location, x-size and y-size are all defined independently as either a pixel value or percentage of the screen.

The horizontal position can be set from the left edge, the right edge or the center of the

object. If positioning the left edge, the object position is defined relative to the left edge of the screen. If positioning the right edge, the object position is defined relative to the right edge of the screen. If positioning the center of the object, the object position is defined relative to the horizontal center of the screen.

For example, the left side of the frame may be specified as 100 pixels from the left edge of the screen. Alternatively, specify that the right edge of the frame should be 10% of screen width from the right edge. Finally, specify that the center of the object is 100 pixels to the right of the center of the screen.

The vertical position and sizes of the object are similarly specified in the anchoring attribute of the object.

All annotation objects also have attributes. The specific attributes depend on the type of object. The attributes define color, line thickness, fill properties, associated images, etc.

Screen Space Images

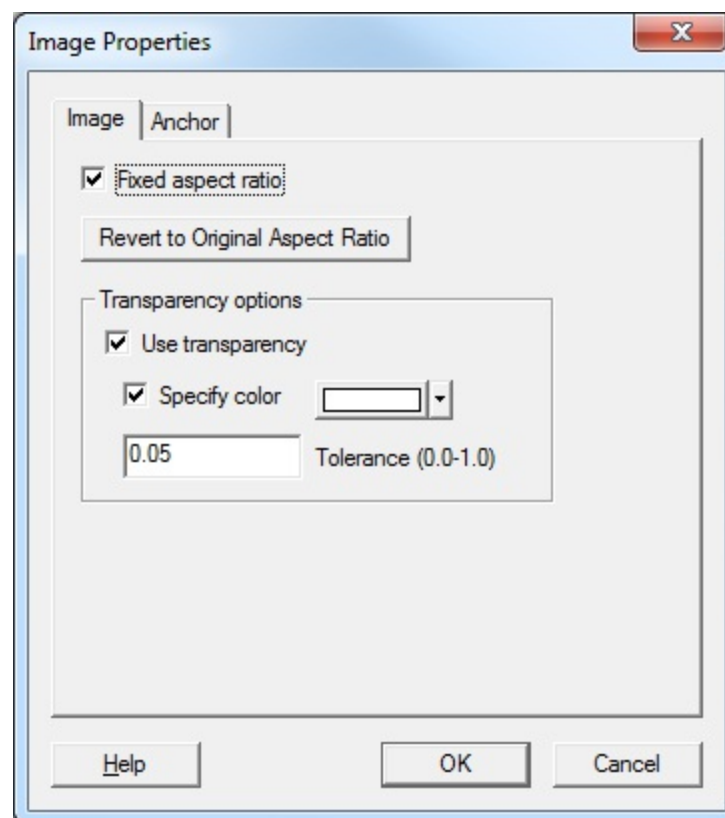

The Image Properties dialog showing the Image tab

A screen space image is simply a graphics icon mapped to the screen. A typical application would be to display a company, department, or municipality logo next to the numeric model being displayed in the graphics window. Image file formats currently supported include the following: BMP, GIF, JPG/JPEG, PNG, SID, and TIF/TIFF.

To add a screen space image, use the **Add Annotation Image**  tool and click anywhere in the graphics window. Use the *Open* dialog to select and add the desired image. Dragging a box in the graphics window will fit the image to the box size.

Using the **Select Annotation Objects**  tool, the image attributes can be changed by right-clicking on the image and selecting the **Properties** command. This will bring up an *Image Properties* dialog with two tabs where the following options can be used:

Image Tab

This tab gives the general image properties.

- *Fixed aspect ratio* – Assigns whether the image is being displayed as a scaled (distorted object), scaled based on its original aspect ratio, or locked at another aspect ratio.
- **Revert to Original Aspect Ratio** – Returns the image to the aspect ratio it had when it was added to the project.
- *Transparency Options* – These options allow for an image to be redrawn with a transparency.
 - *Use transparency* – When checked it will cause the image to be redrawn with the most used color in the image. Clicking the transparency checkbox to the off state causes the image to be redrawn with no transparency.
 - *Specify color* – If checked, it will activate the color button and the color button will have the latest chosen image color painted on it or the most used color in the image, if it has not been activated before. Clicking on the down arrow part of the color button causes a color popup to be displayed with swaths of the 40 most used colors in the image or all the colors in the image, if the image has less than 40 colors. Clicking on one of those colors will cause the image to be redrawn with that color made transparent in the image.

- **Tolerance** – This edit field allows for variation in the matching of the red, green and blue components. The tolerance field ranges in allowable values from 0.0 to 1.0. 0.0 means the red, green and blue components must exactly match. Values higher than 0.0 indicate the degree of variation from the given color.

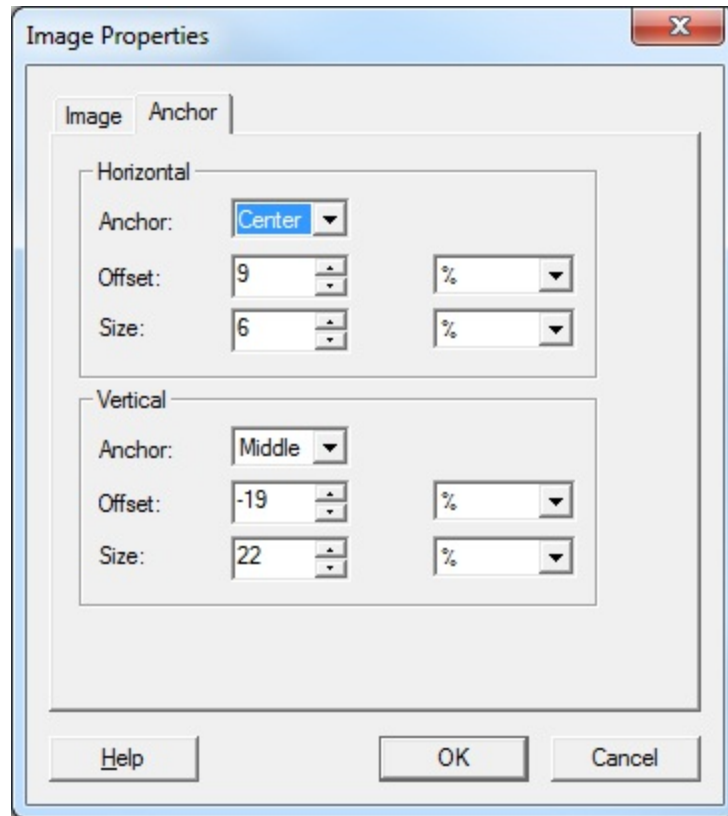

The Image Properties dialog showing the Anchor tab

Anchor Tab

This tab handles options for the size and positioning of the image.

- **Horizontal**

- **Anchor** – The options here determine which direct to move image when moving or resizing the image along the x-axis. Options include "Left", "Center", and "Right". "Left" will offset from the left edge of the image or resize from the left edge. "Right" will use the right edge of the image. "Center" determines the horizontal center of the image and uses that for moving along the x-axis or resizing along the x-axis.

- *Offset* – Moves the image along the x-axis based on the selected anchor type.
- *Size* – Increases or decreases the image size along the x-axis based on the selected anchor type.
- *Vertical*
 - *Anchor* – The options here determine which direction to move image when moving or resizing the image along the y-axis. Options include "Top", "Middle", and "Bottom". "Top" will offset from the top edge of the image or resize from the top edge. "Bottom" will use the bottom edge of the image. "Middle" determines the vertical center of the image and uses that for moving along the y-axis or resizing along the y-axis.
 - *Offset* – Moves the image along the y-axis based on the selected anchor type.
 - *Size* – Increases or decreases the image size along the y-axis based on the selected anchor type.

Scale Bars

A scale bar occupies a fixed size of the screen to display the relative size of the objects in the simulation. Define the minimum width of the scale bar section (in pixels), along with a minimum and maximum height of the scale (also in pixels). The XMS application adds a "Units" label (meters in the image shown below) and labels for the model distance related to the scale divisions.



The program will compute a well conditioned number to use as the scale increment that fits in the specified scale bar extents.

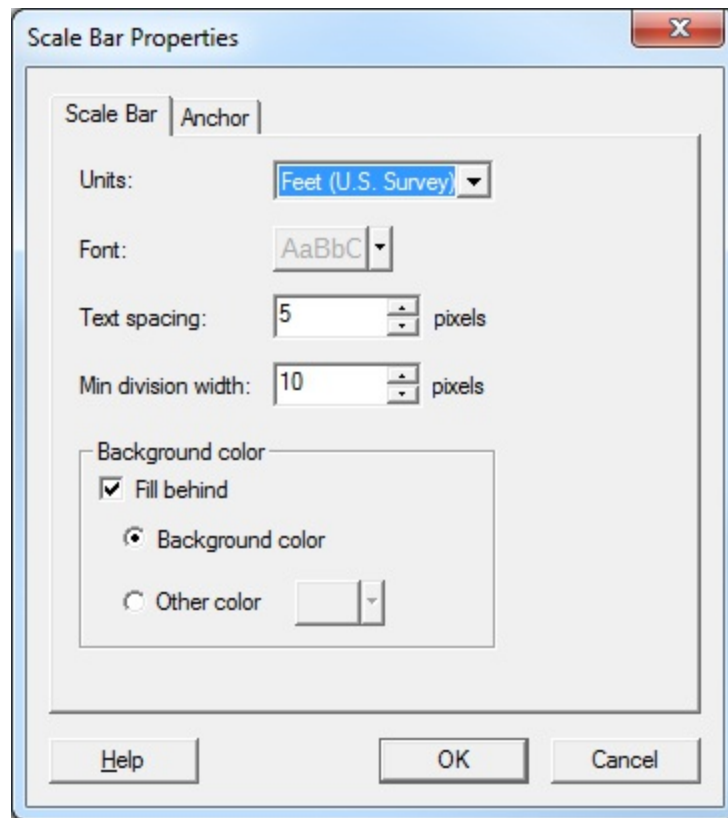

The Scale Bar Properties dialog showing the Scale Bar tab

Using the **Create Scale Bar**  tool, draw a box in the graphics window to indicate the initial size of the scale bar. The *Scale Bar Properties* dialog will appear. This dialog can be reached later by right-clicking on the scale bar and selecting the **Properties** command.

In the *Scale Bar Properties* dialog, attributes of the scale bar include:

- *Units* – Options in "Meters", "U.S. Survey Feet", and "International Feet".
- *Font* – Selecting this button brings up the *Font* dialog where the font type, style, and size are selected. The arrow next to the button will bring up a color picker where the font color can be chosen.
- *Text spacing* – The minimum spacing between distance labels.
- *Min division width* – The minimum division width (in pixels). The XMS application determines the number of divisions based on the minimum division width and the width of the frame.
- *Background* – Opts to fill behind the scale bar with the background color or another

color.

- *Fill behind* – Toggles on or off the option to create a colored field behind the scale bar.
 - *Background color* – Sets the background color as the same background color selected in for the graphics window in the *Display Options* dialog.
 - *Other color* – Clicking this button will bring up a *Color* dialog where a larger selection of colors can be chosen. The arrow next to the button will bring up a color picker with a preset number of color options.
-
- *Anchor* tab – This is identical to the *Anchor* tab in the *Image Properties* dialog.

North Arrows



North arrow objects consist of automatically rotating screen space images. When an XMS application is installed, at least one default north arrow image will be included in the application's home directory, and many are included in the SMS "SupportFiles" folder. Create or download as many north arrow icons as desired. These icons are displayed at the specified location (anchored with the standard options), but will rotate as the view direction changes so that the "up" direction of the icon always aligns with the "North" or positive "Y" direction.

A north arrow object is added by using the **Create North Arrow**  tool. Properties for a north arrow objects are set in the *North Arrow Properties* dialog. This dialog has the the same options as the *Image Properties* dialog.

Text

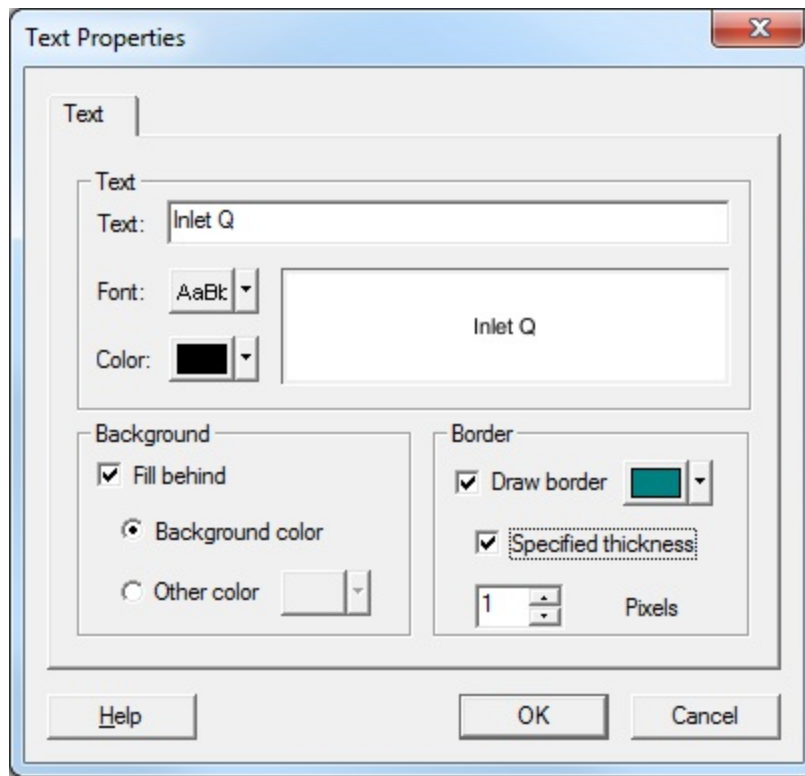

The Text Properties dialog

Text can be created in world or screen space layers.

Enter text by clicking in the graphics window with the **Create Text T** tool active. This will bring up the *Text Properties* dialog. In this dialog, the attributes for the text object can be defined.

The following text attributes can be set:

- **Text** – Options for specifying the text to be displayed and font style.
- **Text** – Field where the text to be displayed is entered.
- **Font** – Selecting this button brings up the *Font* dialog where the font type, style, and size are selected. The arrow next to the button will bring up a color picker where the font color can be chosen.
- **Color** – Another method for selecting the font color. Clicking this button will bring up a *Color* dialog where a larger selection of colors can be chosen. The arrow next to the button will bring up a color picker identical to the one above.

- *Background* – Fill behind the text with the background color or another color.
 - *Background color* – Sets the background color as the same background color selected in for the graphics window in the *Display Options* dialog.
 - *Other color* – Activates color button identical to the one in the *Text* section.
- *Border* – Contains option for defining a border around the text object.
 - *Draw border* – Activates a border around the entire text object. The color button allows changing the border color.
 - *Specified thickness* – Activates the option to change the border thickness. The default border thickness is 1 pixel.

Lines/Arrows

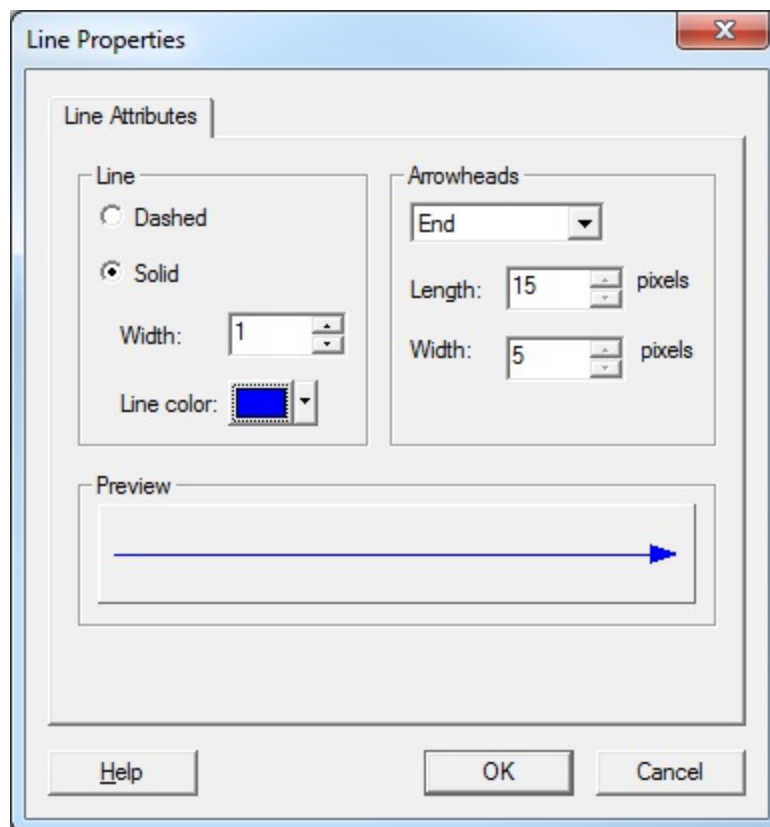

The Line Properties dialog

Create lines or arrows using the **Create Line**  tool. Lines/arrows can be created in screen

or world space layers. Lines can be straight or curved. Click once to start a line. Click again to curve the line. Double-click or hit enter to complete a line. Once the line has been completed, the *Line Properties* dialog will appear. This dialog can also be accessed by right-clicking on the line and selecting the **Properties** command.



In the *Line Properties* dialog, the attributes available for lines and arrows include:

- *Line* – Attributes for a line include:
 - *Dashed* – Sets the line as an evenly spaced dashed line. The length of each dash and the length of each space is a set value that cannot be changed at this time.
 - *Solid* – Specifies the line as a solid line.
 - *Width* – Specified the line width.
 - *Line Color* – Clicking this button will bring up a *Color* dialog where a larger selection of colors can be chosen. The arrow next to the button will bring up a color picker with preset color options.
- *Arrowheads* – This section has option for making the line into an arrow.
 - *Location* – Drop menu that defines where the arrow head will be placed on the line. "None" will leave off arrowheads. "Begin" places the arrowhead where the line was started when created. "End" placed the arrowhead where the line terminated during creation. "Both" places an arrowhead at the start and end of the line.
 - *Length* – Defines the length of the arrowhead. The point of the arrowhead will not go past the start or end point of the line. Increasing the size will move arrowhead further up or down the line.
 - *Width* – Defines the arrowhead width. The arrowhead width will be equally divided along either side of the line.
- *Preview* – Shows what the line or arrow will look like the current selected options. Options are not applied until the **OK** button is clicked.

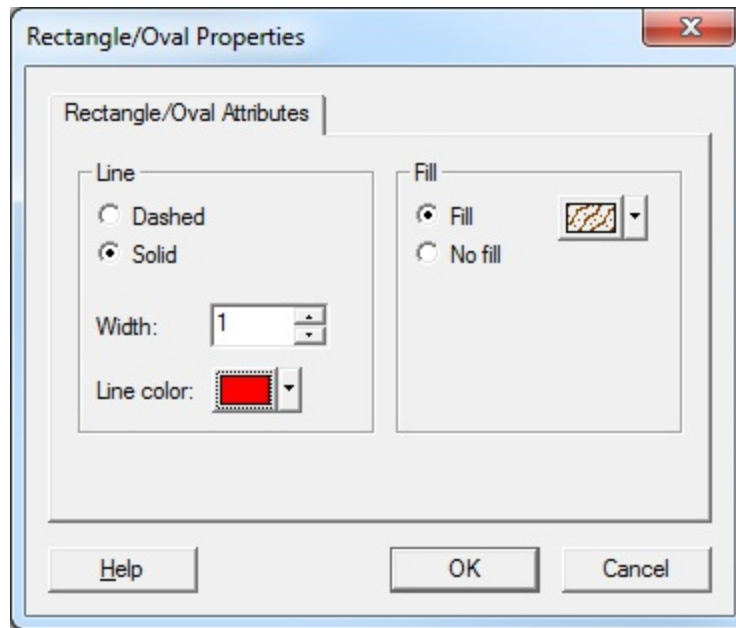
Rectangles and Ovals



The Rectangle/Oval Properties dialog

Create rectangles by dragging a box with **Create Rectangle**  tool active and create ovals with the **Create Oval**  tool active. Rectangles or ovals can be created in world or screen space layers.

After designating where the rectangle or oval will be drawn, the *Rectangle/Oval Properties* dialog will appear. This is the same dialog for both rectangles and ovals. It can also be accessed by right-clicking on the rectangle or oval and selecting the **Properties** command.

IN the *Rectangle/Oval Properties* dialog, the attributes for rectangles and ovals include:

- *Line* – Attributes for a line around the rectangle or oval. Option include:
 - *Dashed* – Sets the line as an evenly spaced dashed line. The length of each dash and the length of each space is a set value that cannot be changed at this time.
 - *Solid* – Specifies the line as a solid line.
 - *Width* – Specified the line width.
 - *Line Color* – Clicking this button will bring up a *Color* dialog where a larger selection of colors can be chosen. The arrow next to the button will bring up a

color picker with preset color options.

- *Fill*
 - *Fill* – Designates that the area of the rectangle or oval will have a solid color. This activates a color button like the one in the *Line* section.
 - *No fill* – Designates that the area of the rectangle or oval will be empty.

Selection

The **Select Annotation Object**  tool is used to select and set attributes for annotation objects. This requires that objects exist to be selected. In this case when using this tool and left-clicking in the annotation object, the object frame will be drawn around the annotation. In addition to the frame, the XMS application displays grab handles on the corners and edges of the frame. Modify the rectangular shape of the annotation by dragging one of the grab handles and changes the position of the object by dragging the annotation (click at any point in the object interior).

Right-clicking on annotation object will produce a menu with the following commands:

- **Delete** – Removes the annotation object.
- **Duplicate** – Creates a copy of the annotation object on the same annotation layer.
- **Properties** – Brings up the properties dialog for the selected object.

Viewing Annotations At Specific Time Intervals

Available in SMS v11.1 and higher, annotations can be setup to be viewed at specific time intervals. This feature is currently under development in GMS. To setup annotations so they only are displayed at specified time intervals do the following:

1. Right-click on the annotation layer in the Project Explorer, then select **Properties...** to open the *Annotation Layer* dialog.
2. Check the *Apply time range* checkbox

3. Modify the *Begin* and *End* time controls to specify the range for when annotations are visible.
4. Click **Ok** to set the time intervals and close the dialog.



Annotations will not be displayed when the specified time range is active. This applies to data in the graphics window and film loops.

See also

- [GMS](#)
- [SMS](#)
- [Layout of the Graphical Interface](#)

CAD Options

DWG and DXF files can be imported into GMS and displayed to assist in model placement or simply to enhance the display of a model.

The objects in a DWG or DXF file are organized into layers. The display of layers  in a CAD drawing is controlled using the check boxes in the [Project Explorer](#). Individual layers can be turned off/on or to turn off the display of all CAD data then uncheck the box next to the " CAD" folder.

The CAD options are included with all [paid editions](#) of GMS. CAD data can be imported with the Community Edition.

CAD Right-Click Menu

Right-clicking on the " CAD" folder in the Project Explorer contains the following commands in addition to the standard object folder commands.

Remove Data

To delete the CAD data right-click on the " CAD" folder in the tree and select **Remove** from the pop-up menu. If the CAD data was imported from a file, the file is not deleted from disk.

CAD → Feature Objects

CAD data can be converted to GMS [feature objects](#) by right-clicking on the " CAD" folder in the [Project Explorer](#) and selecting **CAD To → Feature Objects** command. CAD points are turned into points, CAD lines and polylines are turned into arcs, and CAD polygons are turned into polygons. The feature objects are added to the active coverage. Once converted, the feature objects can be used to build conceptual models.

CAD → TIN

A set of CAD 3D faces which have been imported to GMS can be converted to a [TIN](#) by right-clicking on the " CAD" folder in the [Project Explorer](#) and selecting the **CAD To → TIN** command.

Convert To CAD

This command converts any visible geometric data into CAD format internally within GMS. This CAD data will be saved with the project as a DWG file, or can be exported as a separate DWG or DXF file. This command is found either in the the [Display](#) menu or by right-clicking in the empty space in the [Project Explorer](#).

See also

- [Importing/Exporting CAD Data](#)

Cross Sections

Cross sections—also referred to as fence diagrams—are flat surfaces used to visualize the subsurface. GMS has different types of cross section objects:

- Solid Cross Sections
- [Borehole Cross Sections](#)
- 3D Grid Cross Sections
- 3D Mesh Cross Sections

Solid Cross Sections

Solid cross sections can be created by "slicing" through a set of solids using the [Create Cross Section tool](#). This can be done at any angle and the slicing can be done using a multi-segment polyline. Solid cross sections can be [converted to a conceptual model](#). This is useful if there is a solid model of an embankment to analyze using [UTEXAS](#).

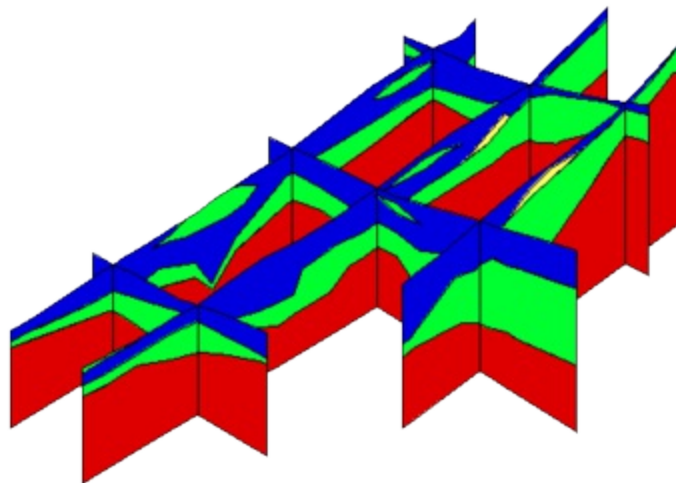

Example of fence diagrams created using solids

Borehole Cross Sections

Borehole cross sections are quite different than solid, 3D grid, and 3D mesh cross sections. See the page on [Borehole Cross Sections](#).

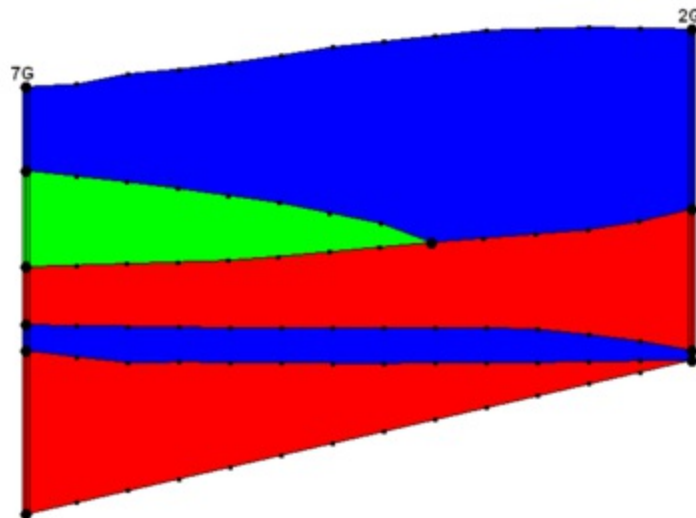

Borehole cross section

3D Grid Cross Sections

3D grid cross sections are [created](#) similar to solid cross sections. Datasets are automatically interpolated from the 3D grid to the cross sections and contours can be displayed on the cross sections.

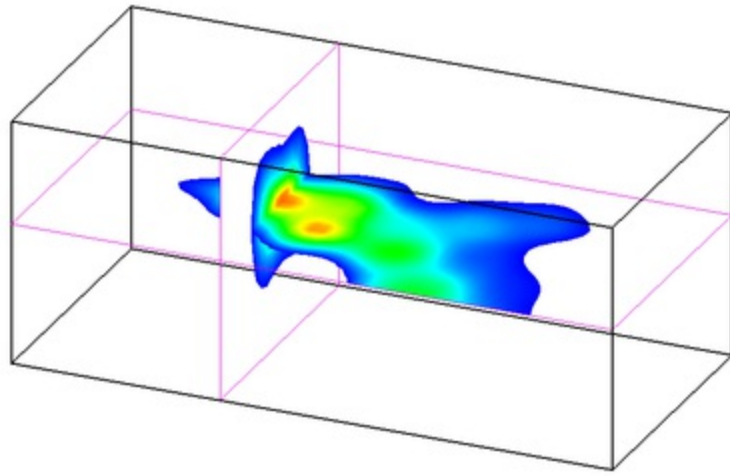

Two cross sections cut through a 3D grid

3D Mesh Cross Sections

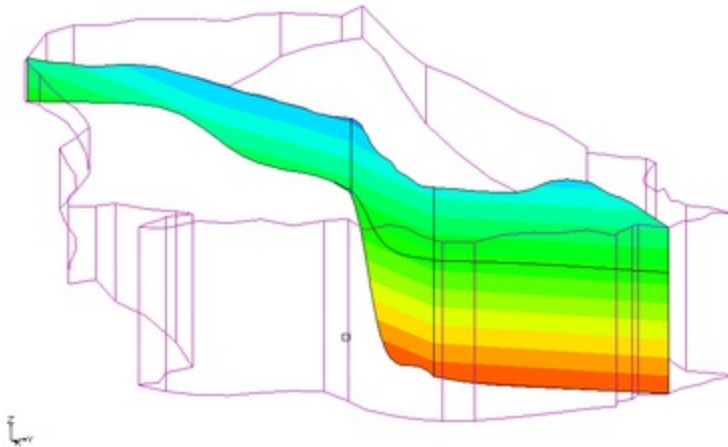

3D mesh cross sections are [created](#) similar to solid cross sections. Datasets are automatically interpolated from the 3D mesh to the cross sections and contours can be displayed on the cross sections.



Multi-panel cross section cut through a 3D mesh

Cross Section Options

When cross sections are created from a mesh or a grid, values of the active scalar and vector datasets are interpolated to the cross sections. Whenever a new dataset is chosen as the active dataset for the mesh, the data values are re-interpolated to the cross sections.

The properties of all cross section data that GMS displays on the screen can be controlled through the *Cross Sections* tab of the *Display Options* dialog. This dialog is opened by right-clicking on the Cross Sections  entry in the [Project Explorer](#) and selecting the **Display Options** command. It can also be accessed from the *Display* menu or the **Display Options**  macro. The following describes the display options available for the cross sections.

- *Interior edge removal* – By default, the lines representing the intersection of the cross section with the faces of the cells or elements are displayed on the cross section. These lines can be hidden by selecting the Interior edge removal option.
- *Cross section edges* – If this option is on, the lines that make up the cross section are displayed.
- *Cross section faces* – If this option is on, then the cross section will be displayed as a set of filled polygons.
- *Contours* – If the Contours item is selected, contours are displayed on the cross sections using the active scalar dataset.
- *Vectors* – If the Vectors item is selected, vectors are displayed on the cross sections using the active vector dataset when the cross sections are displayed.
- *Flow trace* – If the Flow trace item is selected, a flow trace image is texture mapped to each cross section using the active vector dataset when flow trace option is used with the *Animation* wizard.

Convert Cross Section to Coverage

Cross sections can be converted to coverages by right-clicking on the coverage and selecting the **Convert To Coverage** command. The outer boundary of each material zone is converted into arcs and polygons are automatically built.

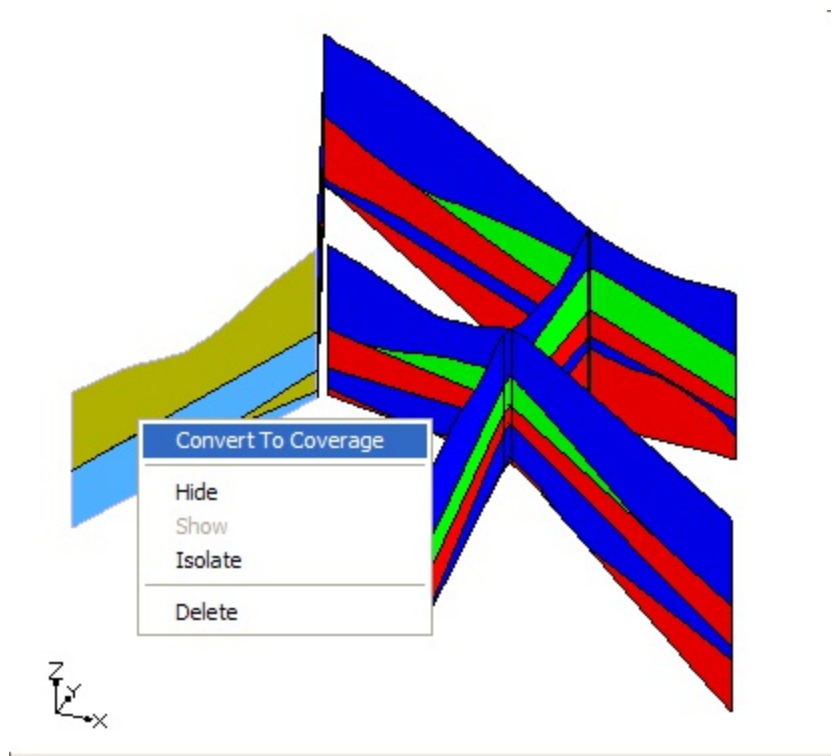

Converting a cross section to a coverage

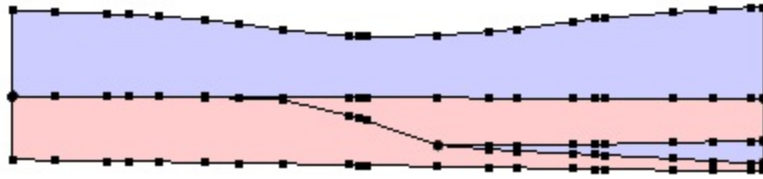

The resulting coverage from the cross section

When this command is executed, a prompt will ask to select where the new coverage(s) should be created in the project explorer. If wanting to have the materials from the cross section assigned to the appropriate polygons in the coverage then select an appropriate conceptual model. The conceptual model must support the assignment of materials to polygons (MODFLOW, SEEP2D/UTEXAS, FEMWATER).

Coordinate Transformation

The coordinates of points from the cross section are transformed into the XY plane. The x coordinates are calculated relative to zero where zero is defined as one end of the cross section. Currently the end of the cross section that is designated as zero is the end with the minimum Y coordinate. If the cross section is horizontal then the end of the cross section with the minimum X is used.

The x coordinates are calculated by finding the distance of the point from the end of the cross section that was set as zero. The Y coordinates are calculated by subtracting the minimum z value of the cross section from the z value of the point ($y = z - z_{\min}$).

Limitations

- The cross section must be vertical.
- The cross section must be a single panel (when viewing the cross section in plan view it appears as a single line segment).

Datasets

A dataset is a set of values associated with each node, cell, vertex, or scatter point in an object. A dataset can be steady state (one value per item) or transient (one value per item per time step). The values in the dataset can be scalar values or vector values. Certain types of objects in GMS have an associated list of scalar datasets and a list of vector datasets. Each of the following objects in GMS can have both scalar and vector datasets:

- [TINs](#)
- [2D Meshes](#)
- [2D Grids](#)
- [3D Meshes](#)
- [3D Grids](#)
- [UGrids](#)

The following objects can only have scalar datasets:

- [Borehole Sample Data](#)
- [2D Scatter Point Sets](#)
- [3D Scatter Point Set](#)

The commands for manipulating datasets are located in the *Edit* menu.

Datasets are used for both pre- and post-processing of models. For example, a scalar dataset associated with a 3D grid can represent starting values of head or values of hydraulic conductivity for a groundwater modeling problem. Another dataset associated with

the same grid may represent computed head values. Datasets can be used to generate contours, [isosurfaces](#), [vector plots](#), and [animation](#) sequences.

Generating Datasets

Datasets can be generated in a variety of ways. They can represent output from a groundwater model (head, drawdown, etc.). They can represent tabular values in a text file entered manually or exported from another application such as a GIS. They can be created by [interpolating](#) from a scatter point set to a TIN, grid, or mesh. Datasets can also be generated by performing mathematical operations on other datasets with the [Data Calculator](#).

One advantage of the dataset list approach for managing information is that it facilitates transfer of information between different types of models or models with differing resolution. This is accomplished through scatter point sets and interpolation. TINs, borehole contacts, borehole sample data, grids, and meshes can all be converted to a 2D or 3D scatter point set. When an object is converted to a scatter point set, all scalar datasets associated with the object are copied to the new scatter point set. The datasets can then be transferred from the scatter point set group to other objects of any type using one of the supported interpolation schemes.

Importing/Exporting Datasets

A dataset can be exported by right-clicking on the dataset in the [Project Explorer](#) and select the **Export** command. The *Save As* dialog has three filter types that can be exported:

- Binary Dataset Files (*.dat)
- ASCII Dataset Files (*.dat)
- HDF5 Dataset Files (*.h5)

A dataset can be imported by right-clicking on any of the objects explained above in the [Project Explorer](#) and select the **Import Dataset** command. This command brings up the *File Open* dialog.





Project Explorer

Datasets are displayed and managed in the [Project Explorer](#) to learn more. See [Datasets in the Project Explorer](#) to learn more.

Active Dataset

Each object (TIN, grid, mesh, or scatter point set) in GMS has a set of values which is designated as the "active dataset." The active dataset is an important part of model visualization in GMS. Each time the display is refreshed, the contours and other display features are generated using the active dataset.

The active dataset and time step are displayed in the [Project Explorer](#). Clicking on a solution or dataset in the [Project Explorer](#) makes that item "active" and the display is automatically updated in the GMS window. The table below shows the icons displayed next to the active datasets.

	active scalar dataset on cells
	active scalar dataset on points
	active vector dataset
	active ccf dataset

Dataset Info

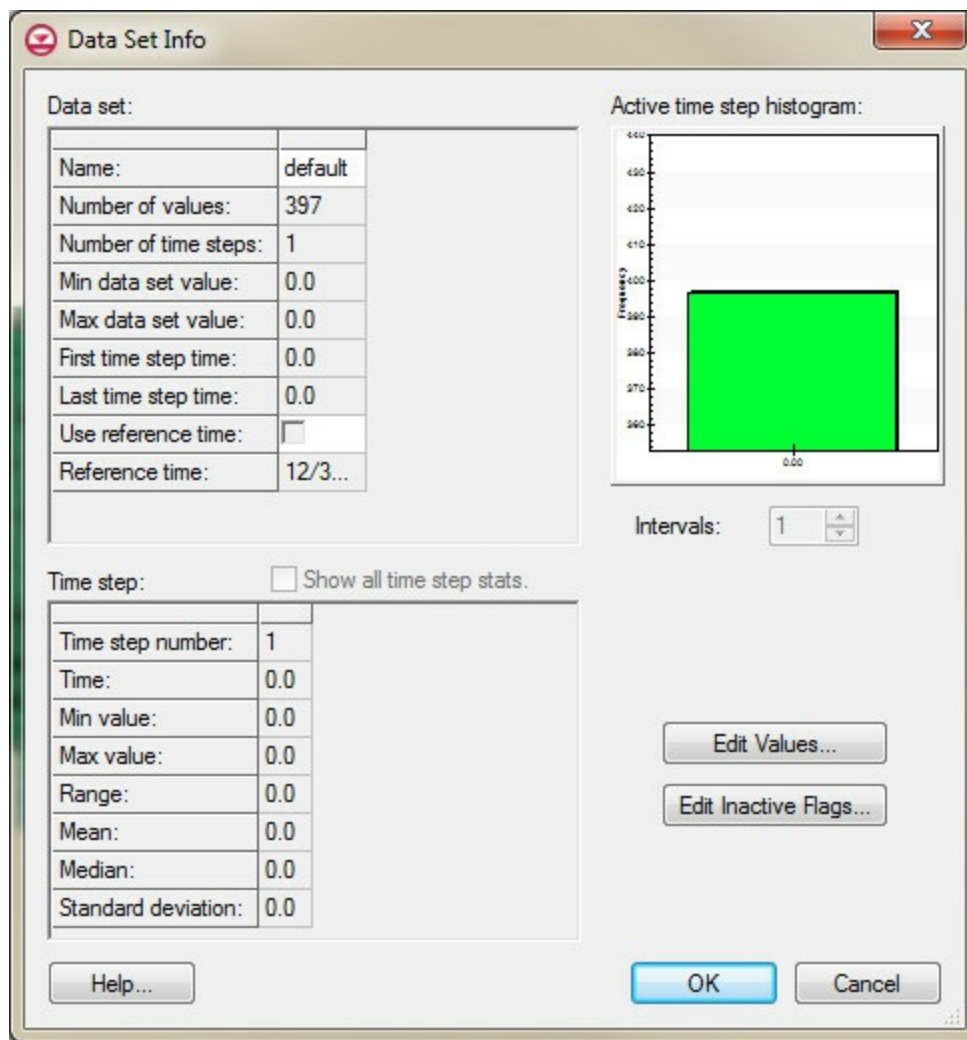

Example of the Dataset Info dialog

Selecting the **Properties** command in the right-click menu on a dataset in the [Project Explorer](#) will bring up the *Dataset Info* dialog. The components of the dialog are as follows:

Statistics

A set of statistics related to the active dataset is displayed on the left side of the *Dataset Info* dialog. the statistics for all time steps can be shown by selecting the *Show all time step stats.* toggle. A histogram of the data values is displayed on the right side. The histogram shows the value intervals on the x-axis, and the number of occurrences within that interval on the y-axis (for example the head output dataset histogram from a MODFLOW model will show the number of active cells with final head values within a given interval). Right-clicking on the plot and selecting the **Plot Data** command brings up the *X-Axis Precision* dialog. This dialog enables users to set the precision of the x-axis of the

Histogram.

View/Edit Values

For datasets associated with model solutions, the data values can be displayed in a spreadsheet using the **View Values** button. For all other datasets, the button label changes to **Edit Values** and the spreadsheet can be used to change the dataset values.

Active/Inactive Flags

If the currently selected module is the 3D Grid module, the active/inactive status of cells can be changed by selecting the **Edit** button at the bottom left of the dialog. This brings up the *Active/Inactive Flags* dialog.

Date/Time Display









For a transient dataset, the time values can be displayed in the Time Step Window using either a relative time format (e.g., 100.0) or using a date/time format (e.g., 1/12/1998 3:23:48). The relative times are computed using a reference time that is defined for the model (MODFLOW, FEMWATER etc.). The reference time represents the date/time corresponding to $t=0$.

Datasets in the Project Explorer

The solutions and datasets associated with a particular object (grid, mesh, scatter point set, etc.) are managed using the [Project Explorer](#).



Datasets

Three different types of datasets are shown in the Project Explorer: scalar, vector, and ccf. For scalar datasets, they can be associated with either cells or points. The icons used to identify the datasets are shown below.

Dataset Type	Active	Inactive
scalar dataset on cells		
scalar dataset on points		
vector dataset		
ccf dataset		

If the active dataset is transient then the time steps are displayed in the [Time Step Window](#).

Solutions

Solutions are output from a [numerical model](#) that GMS supports. Solutions are shown in the [Project Explorer](#) as a folder with a lock on it . If a solution is transient then the time steps are displayed in the [Times Step Window](#). Datasets can not be moved into or out of a solution folder. Also, the solution may contain text files such as the *.out and *.glo files produced by MODFLOW. These files can be viewed by right-clicking on the  item and selecting **View File** from the pop-up menu, or by double-clicking on the item.

Clicking on a solution or dataset makes that item "active" and the display is automatically updated in the GMS window.

Folder

The datasets and solutions are organized by folders. The user can create new folders and move datasets, solutions, and folders to other folders anywhere on the [Project Explorer](#). Folders can be created by right-clicking on the certain items in the [Project Explorer](#) and selecting **New Folder** in the menu. A dataset or folder can be deleted simply by selecting the folder and selecting the *Delete* key or by right-clicking on the item and selecting the **Delete** option in the corresponding pop-up menu. Statistics about a dataset can be viewed by right-clicking on a dataset and selecting the **Properties** option from the pop-up menu.

Data Calculator

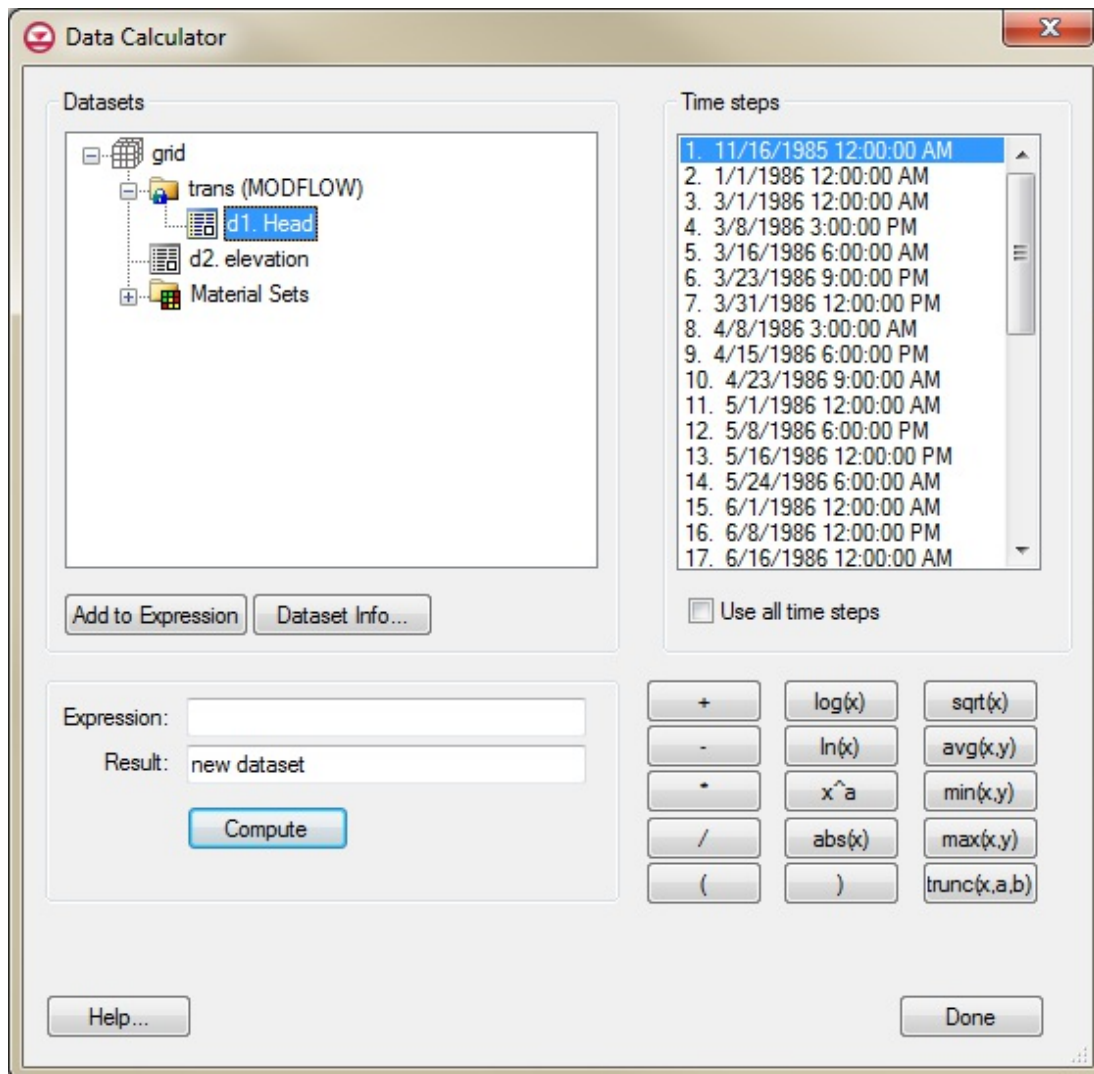

The Data Calculator dialog

The *Data Calculator* can be used to perform mathematical operations with datasets to create new datasets. The *Data Calculator* is accessed by selecting the **Data Calculator** command from the *Data* or *Edit* menu. The components of the *Data Calculator* are as follows:

Expression Field

The most important part of the *Data Calculator* is the *Expression* field. This is where the mathematical expression is entered. The expression should be formulated using the same

rules that are used in formulating equations in a spreadsheet. Parentheses should be used to clearly indicate the preferred order of evaluation. There is no limit on the length of the expression. The operators in the expression should be limited to the operators shown in the middle of the *Data Calculator*. The operands in the expression should consist of user-defined constants (e.g., 3.14159), or datasets.

List of Datasets

All of the datasets associated with the active object (TIN, Grid, Mesh, or Scatter Point Set) are listed at the top of the Data Calculator. If a transient dataset is highlighted, the time steps are listed on the right side of the Data Calculator. When a dataset is used in an expression, the name of the dataset should NOT be used. Rather, the letter associated with the dataset should be used. For example, if a dataset is listed as "b. head1", the dataset is referenced in the expression simply as "b"

When a transient dataset is used in an expression, either a single time step or the entire sequence of time steps may be used. For example, the expression "abs(d:100)" creates a single (steady state) dataset representing the absolute value of the dataset at time = 100.0. However, the expression "abs(d:all)" creates a transient dataset representing the absolute value of each of the time steps in the original dataset.

Result Name

When an expression is evaluated, a new dataset is created and the name of the new dataset is designated in the *Result* field.

Operators

The allowable operators are listed in the middle of the dialog. Selecting one of the operator buttons adds the selected operator to the end of the expression. However, the operators can also be typed directly in the expression field. The function of each of the operators is as follows:

Operator	Function
+	Add
-	Subtract
*	Multiply
/	Divide
(Left parenthesis
)	Right parenthesis
log(x)	The base 10 logarithm of a dataset
ln(x)	The natural logarithm of a dataset
x^a	(x) raised to the (a) power. (x) and (a) can be any mixture of constants and datasets
abs(x)	The absolute value of a dataset
sqrt(x)	The square root of a dataset
ave(x,y)	The average of two datasets
min(x,y)	The minimum of two datasets
max(x,y)	The maximum of two datasets
trunc(x,a,b)	Truncates a dataset (x) so that all values are $\geq a$ and $\leq b$
1/(x)	The inverse of (x) - Only available in SMS

Operating With Transient Datasets

Each argument in the operators listed in the table above may be:

- A steady state (1 time step) dataset
- A specified time step of a transient dataset (i.e., x:#). In this case the # represents the index of the time step as specified in the time step window.
- A transient time step (i.e., x:all). These operations are only valid if all arguments have matching time step values. In this case, the result will be a new transient dataset with identical time values as the arguments.

The data calculator supports an alternate format for computing attributes of a transient dataset. This alternate format applies to three of the operators. These operators compute a single time step (steady state) dataset representing the spatially varied attribute operating on all the time steps.

Operator	Function
ave(x:all)	The average at each location of all time steps in the dataset
min(x:all)	The minimum at each location of all time steps in the dataset
max(x:all)	The maximum at each location of all time steps in the dataset

Compute Button

Once an expression is formulated and a name for the resulting dataset has been specified, the expression can be evaluated by selecting the **Compute** button. At this point, the dataset is created and the name of the new dataset should appear in the list of datasets.

Related Links

- [Datasets \(GMS\)](#)
- [Datasets \(WMS\)](#)

Display Theme

A *Display Theme* is a collection of display options. Display themes are a way to create and save display options for later use. The look of the data can be quickly changed using display themes.

Create a display theme by right-clicking in the blank space of the Project Explorer and selecting the **New | Display Theme** menu command. This will bring up the *Display Theme Properties* dialog. In this dialog, name the display theme, select which display options to include in the display theme, and enter the names of items that will automatically use the display theme. When closing the dialog, a new display theme  data object will appear in the Project Explorer. This data object stores all of the **display options** as set when the object was created.

Display Theme Right-Click Menu

Display theme  objects in the Project Explorer have the standard right-click menu options. Display theme objects also have the following two options:

Update With Current Display

Changes the display theme to match the current display options.

Properties

Brings up the *Display Theme Properties* dialog.

Display Theme Properties

The *Display Theme Properties* dialog defines which display options to show with the saved display theme.

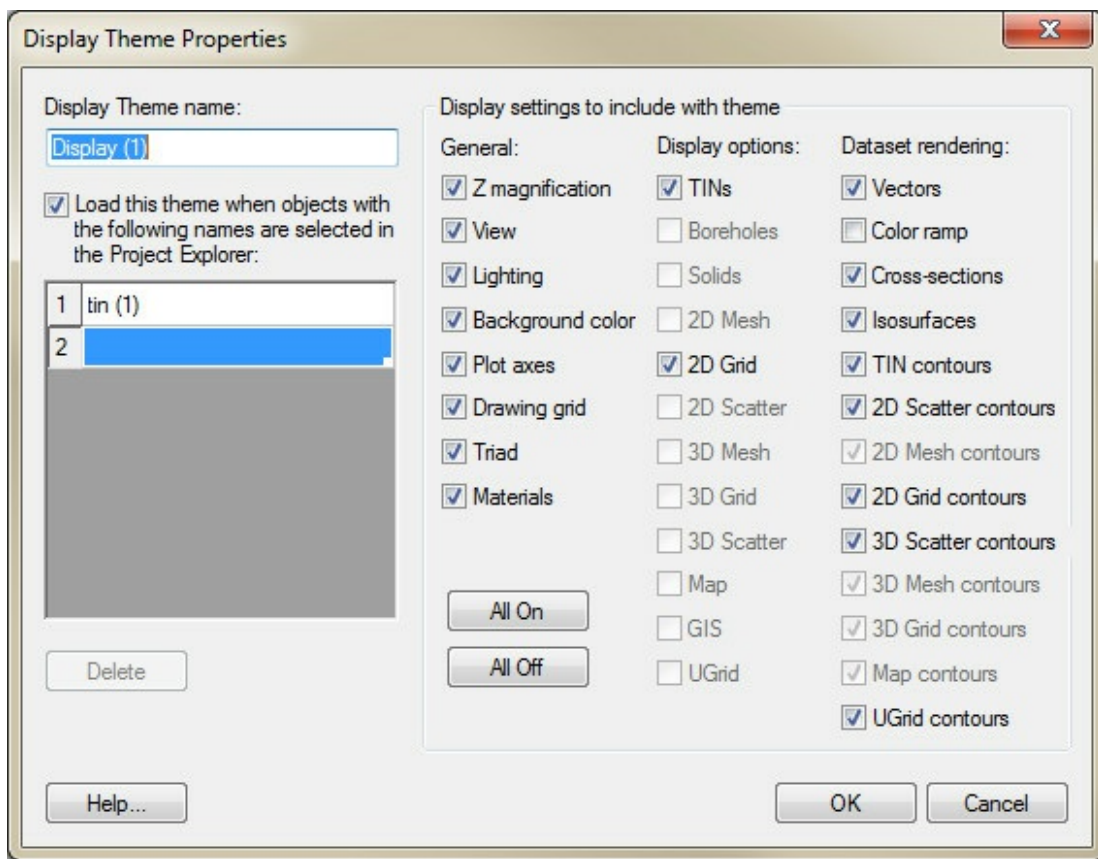

The Display Theme Properties dialog

- *Load this theme when objects with the following names are selected in the Project Explorer* – Used to automatically load display themes for object selected in the Project Explorer from the list below this option. The names of objects must be listed with the exact name as used in the Project Explorer.

For more information on display themes see the Display Themes tutorial in the article [Tutorials](#).

Related Topics

- [Display Options](#)

Help Menu

The *Help* menu is one of the standard menus and is available in all of the modules. The commands in the *Help* menu are to assist in using GMS.

The commands in this menu are:

GMS Help

Launches the GMS Help file or brings up the [XMS wiki](#) depending which the user has specified in the *Preferences* dialog.

Learn GMS

Will open up the GMS Learning Center at <http://www.aquaveo.com/software/gms-learning>. This command requires an internet connection.

Register GMS

Brings up the *Register* window. Here the user can see which components have been registered and make changes to the registration. See the article [Registering GMS](#) for more information.

About

Brings up the *About GMS* dialog that contains information about the software version and build date. It also includes copyright information and information for contacting technical support.

Check for Updates

Searches for updates to the current version. This command requires an internet connection to function. If updates are found, the user will be given the option to install the latest version.

Report A Bug

Allows reporting issues with SMS. Activating this command will bring up the *Report Bug* dialog. See the article [Report A Bug](#) for more information.

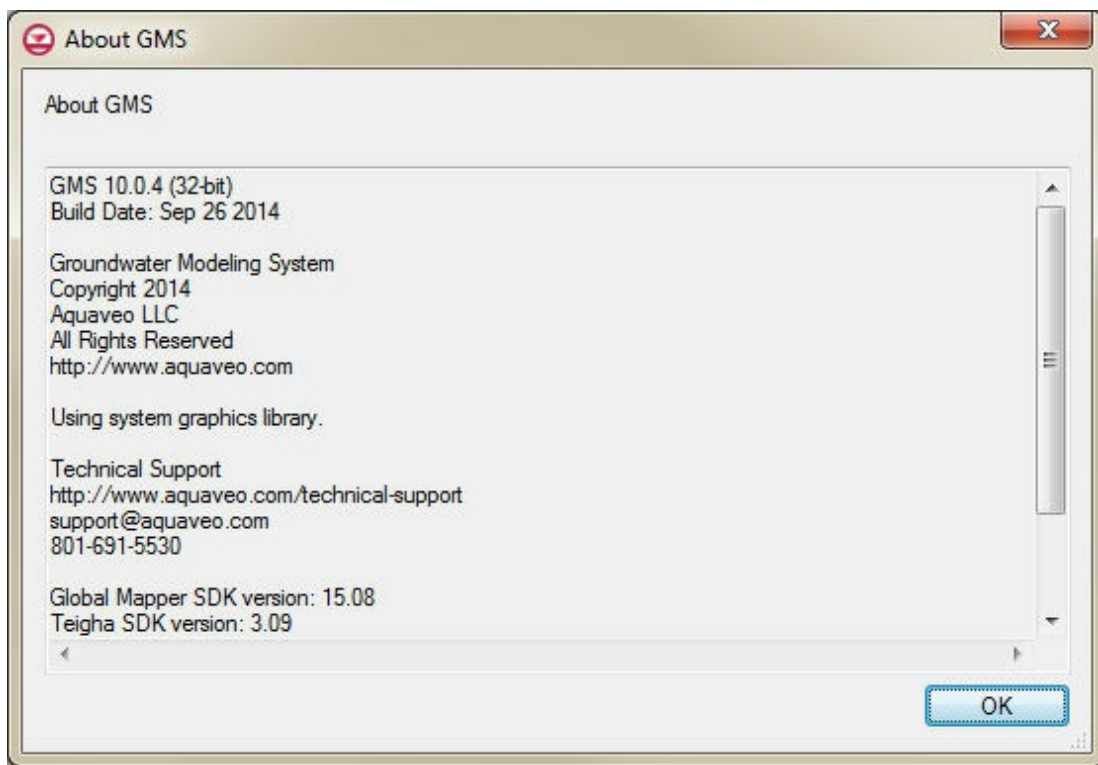

Example of the About GMS dialog.

Related Topics

- [GMS Menus](#)

Keyboard Shortcuts

Many commands in GMS are can be accessed using keyboard shortcuts.

Standard Menu Shortcuts

Shortcuts for standard menu commands are listed in the table below.

Modifier	Key	Command
CTRL	F	<i>Display</i> Frame Image
CTRL	R	<i>Display</i> Refresh
CTRL	D	<i>Display</i> Display Options
CTRL	H	<i>Display</i> Hide
CTRL	W	<i>Display</i> Show
	DELETE	<i>Edit</i> Delete
CTRL	C	<i>Edit</i> Screen Capture
CTRL	V	<i>Edit</i> Paste Text
CTRL	A	<i>Edit</i> Select All
CTRL	U	<i>Edit</i> Unselect All
CTRL	O	<i>File</i> Open
CTRL	P	<i>File</i> Print
CTRL	S	<i>File</i> Save Project
SHIFT	A	<i>Display</i> <i>View</i> View Angle
SHIFT	W	<i>Display</i> <i>View</i> Window Bounds
SHIFT	F	<i>Display</i> <i>View</i> Front
SHIFT	O	<i>Display</i> <i>View</i> Oblique
SHIFT	P	<i>Display</i> <i>View</i> Plan
SHIFT	V	<i>Display</i> <i>View</i> Previous
SHIFT	S	<i>Display</i> <i>View</i> Side
	F2	Rename (when in the Project Explorer)
	F2	Pan (when in the Graphics Window)
	F3	Zoom
	F4	Rotate

Notes

Notes can be added to most objects or to the project itself to aid in model development. For example, a model developer might add a note to a dataset used to interpolate elevations to describe the real world source of the data. Typical notes might be to describe what an object is, where it came from, or why the developer did something a particular way.

Automatic Notes

GMS will create some notes automatically if the *Create GMS notes automatically* option is turned on in the *General* tab of the *Preferences* dialog. Initially, automatic notes are created only on [UGrids](#) when they are created, on [datasets](#) when they are created through interpolation or the *Data Calculator*, or on [coverages](#) when they are created from other objects. This list may be expanded in future releases.

Object Notes

Notes for objects are accessed via a tab on the *Properties* dialog.

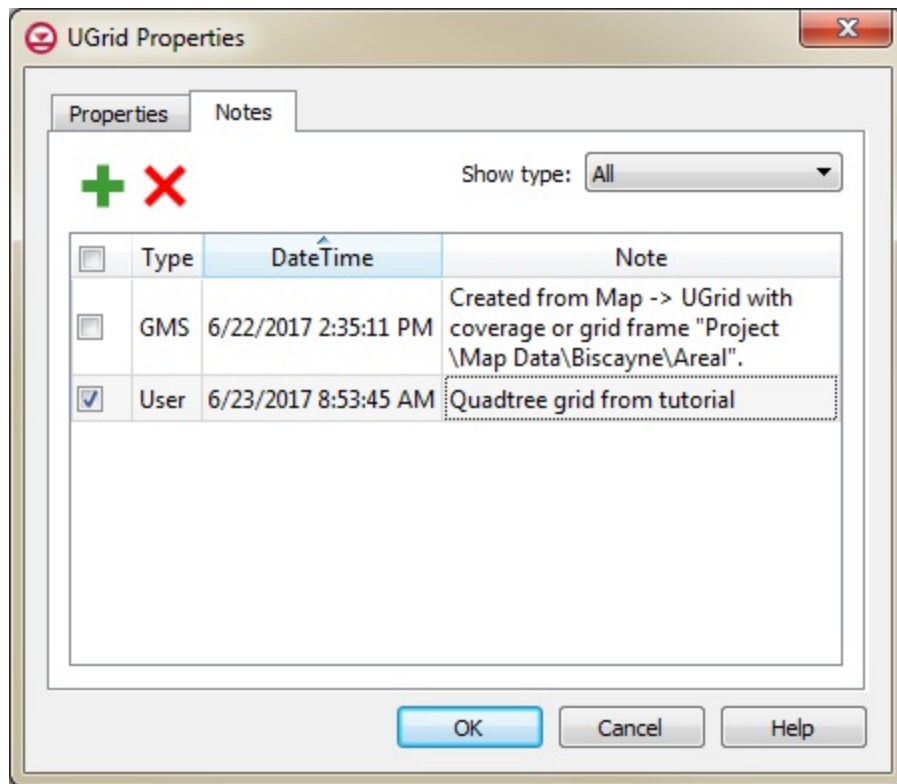

Notes tab in a Properties dialog.

Notes are given a time stamp when they are created and the notes can be sorted by time in ascending or descending order. Add notes by clicking the **Add row** **+** button. Remove notes by selecting the note and clicking the **Delete** **X** button.

The dialog has options for showing all notes, only GMS created notes, or only user created notes.

All Notes

All notes for all objects can be viewed via the [Edit | Notes](#) command. In this dialog, notes cannot be created, but they can be deleted. Remove notes by selecting the note and clicking the **Delete** **X** button.

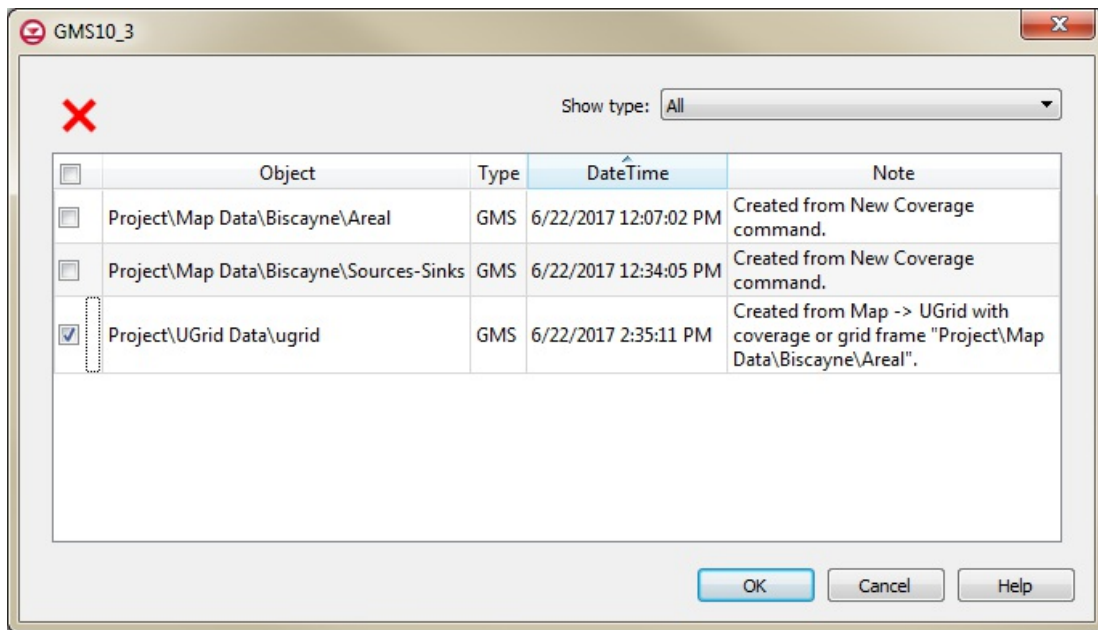

All notes dialog

Window Menu

The *Window* menu is one of the standard menus available regardless of the current module and model. It contains commands on how to arrange windows that are active in GMS. The *Window* menu includes the following commands:

Cascade

Arranges all windows in an overlapping fashion within the GMS Graphics window.

Tile Vertically

Arranges all windows as non-overlapping vertical tiles within the GMS Graphics window.

Tile Horizontally

Arranges all windows non-overlapping horizontal tiles within the GMS Graphics window.

Selection Echo

Opens or closes the [Selection Echo](#) window in the GMS window. The Selection Echo window will display the properties of a selected object, point, cell, elements, etc...

Active Window

A list of the currently open graphics and plot windows is shown at the bottom of the *Window* menu. A check mark appears in front of the active window. Choose a window from the list to make it active.

Related Topics

- [GMS Menus](#)

XY Series Editor

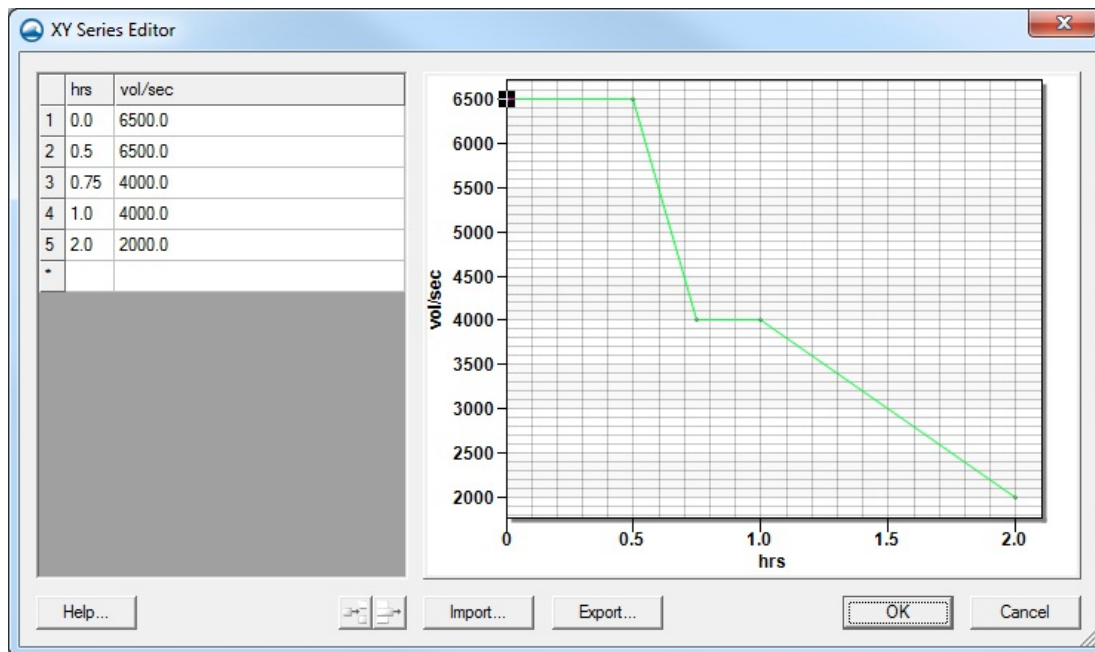

Example of the XY Series Editor dialog

The *XY Series Editor* is a special dialog that is used to generate and edit curves defined by a list of x and y coordinates. The curve can be created and edited by directly editing the xy coordinates using a spreadsheet list of the coordinates. An entire list of curves can be generated and edited with the Editor and curves can be imported from and exported to text files for future use. It is also possible to paste xy data directly to the spreadsheet.

The *XY Series Editor* is used in GMS, SMS, and WMS. It was designed to be general in nature so that it could be used anywhere that a curve or function needs to be defined. In some cases, the x values of the curve must correspond to a pre-defined set of values. For example, the x values may correspond to a set of time steps whose interval is established in a separate dialog. In such cases, the x fields cannot be edited but the y values associated with the pre-defined x values can be edited. In other cases, there is no limit on the number of x values or on the x spacing and both the x and y values can be edited.

The XY Edit Fields

The two vertical columns of edit fields on the left side of the dialog are for direct editing of the xy series values. A pair of application specific titles appears at the top of the columns.

The buttons below the xy edit fields are used to manipulate the values in the edit fields. The buttons are as follows:

Use dates/times

For selected situations such as entering time series data in the Map module, it is useful to enter the data in date/time format. Checking this toggle allows the x values in the curve to be entered in date/time format.

Import/Export Buttons

The **Import** and **Export** buttons allow reading in or saving an xy series file.

The XY Series Plot

The window in the upper right hand corner of the *XY Series Editor* is used to plot the curve corresponding to the xy values in the edit fields. As each value in the edit fields is edited, the corresponding point on the curve is adjusted instantaneously. Plot options are accessed by right-clicking on the plot.

Related Pages

- [GMS main page](#)
- [SMS main page](#)
- [WMS main page](#)

4. Interpolation

4.1. Introduction

Interpolation

GMS contains a powerful suite of interpolation tools. GMS can interpolate to [TINs](#), [2D meshes](#), [2D grids](#), [3D meshes](#), [3D grids](#), and [UGrids](#). In addition to interpolating scalar values, GMS also supports interpolation of materials with [T-PROGS](#). The T-PROGS software is used to perform transition probability geostatistics on [borehole data](#).

Interpolation Types

The following types of interpolation are available in GMS:

Clough-Tocher

The Clough-Tocher interpolation technique is a finite element method because it has origins in the finite element method of numerical analysis. Before any points are interpolated, the points are first triangulated to form a network of triangles. A bivariate polynomial is defined over each triangle, creating a surface made up of a series of triangular Clough-Tocher surface patches.

Gaussian Field Generator

A Gaussian Sequential Simulation (GSS) is used to generate a set of scalar datasets (Gaussian fields) using a Gaussian sequential simulation. This is somewhat similar to indicator kriging or T-PROGS in that it generates a set of equally probable results which exhibit heterogeneity and are conditioned to values at scatter points. However, the resulting arrays are floating point scalar datasets, rather than the integer arrays produced by T-PROGS and indicator kriging.

Inverse Distance Weighted

Inverse Distance Weighted (IDW) is one of the most commonly used techniques for interpolation of point data. Its methods are based on the assumption that the interpolating surface should be influenced most by the nearby points and less by the more distant points.

Jackknifing

Jackknifing is a special type of interpolation useful in analyzing a scatter point set or an interpolation scheme. When the Jackknifing, the active scatter point set is interpolated to itself using the currently-selected interpolation scheme. Each point in the set is processed one at a time. The point is temporarily removed and the selected interpolation scheme is used to interpolate to the location of the missing point using the remaining points. This generates a new dataset for the scatter point set. This new dataset can then be compared with the original dataset.

Kriging

Kriging is based on the assumption that the parameter being interpolated can be treated as a regionalized variable. A regionalized variable is intermediate between a truly random variable and a completely deterministic variable because it varies in a continuous manner from one location to the next. Therefore points that are near each other have a certain degree of spatial correlation, but points that are widely separated are statistically independent. Kriging is a set of linear regression routines which minimize estimation variance from a predefined covariance model.

Linear

The Linear interpolation scheme uses data points that are first triangulated to form a network of triangles. The network of triangles only covers the convex hull of the point data, making extrapolation beyond the convex hull not possible.

Natural Neighbor

Natural neighbor interpolation is based on the Thiessen polygon network of the point data. The Thiessen polygon network can be constructed from the Delaunay triangulation of a set of points. A Delaunay triangulation is a network of triangles that has been constructed so that the [Delaunay criterion](#) has been satisfied. As with [IDW interpolation](#), the nodal functions can be either constants, gradient planes, or quadratics.

How To Interpolate in GMS

Interpolation is performed using the [2D Scatter Points](#) and the [3D Scatter Points](#). To interpolate values from a scatter set either right-click on a scatter set in the Project Explorer and select the **Interpolate to** command or select the command from the [Interpolation menu](#). The commands in the *Interpolation* menu act on the "active" item in the Project Explorer.

[UGrids](#) can also be interpolated to other Ugrids.

Related Topics

- [2D Interpolation Options](#)
- [3D Interpolation Options](#)

Interpolation Commands

Once a 3D interpolation scheme has been selected and the appropriate parameters for the selected scheme have been input, the dataset of the active scatter point set can be interpolated to another object. During the interpolation process, a new dataset is constructed for the target object containing the interpolated values. A separate interpolation command is provided for interpolating to each of the target objects. The interpolation commands are found in the *Interpolation* menu. The commands in this menu are as follows:

Interpolation Options

Opens the [Interpolation Options](#) dialog to change the interpolation method.

Interpolate → Active TIN

Interpolates to the vertices of the active TIN.

Interpolate → 2D Mesh

Interpolates to the nodes of the 2D finite element mesh.

Interpolate → 2D Grid

Interpolates to the 2D finite difference grid. The interpolation is done either to the grid nodes or to the grid cell centers depending on whether the grid is a mesh-centered or cell-centered grid. (See [2D Grid Types](#).)

Interpolate → 3D Mesh

Interpolates to the nodes of the 3D finite element mesh.

Interpolate → 3D Grid

Interpolates to the 3D finite difference grid. The interpolation is done either to the grid nodes or to the grid cell centers depending on whether the grid is a mesh-centered or cell-centered grid. (See [2D Grid Types](#).)

Interpolate → MODFLOW Layers

The [Interpolate to MODFLOW Layers](#) command allows interpolating from 2D scatter data to MODFLOW data: top and bottom layer elevations, LPF array data (HK, VK, etc), recharge.

Interpolate → UGrid

Interpolates to the cells of the active UGrid.

Gaussian Simulation Options

[Gaussian Sequential Simulation \(GSS\)](#) is a form of Kriging that can only be used for 2D interpolation and only works when interpolating to 3D cell-centered grids.

Jackknifing

3D Jackknifing: Interpolates the active scatter point set to itself using the currently selected interpolation scheme. 3D jackknifing is identical to [2D Jackknifing](#).

When one of the interpolation commands is selected, the *Interpolate*→*Object* dialog appears. This dialog shows the interpolation being used and has an option to bring up the [Interpolation Options](#) dialog to change the interpolation method. The *Interpolated dataset name* can also be specified for the new dataset being generated.

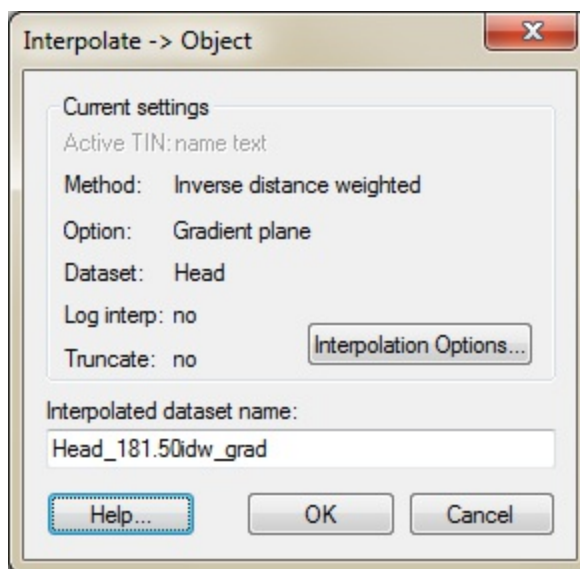

Example of the Interplate → Objects dialog

See also

- [Interpolating with 3D Scatter Points](#)
- [Interpolating with 2D Scatter Points](#)

3D Interpolation Options

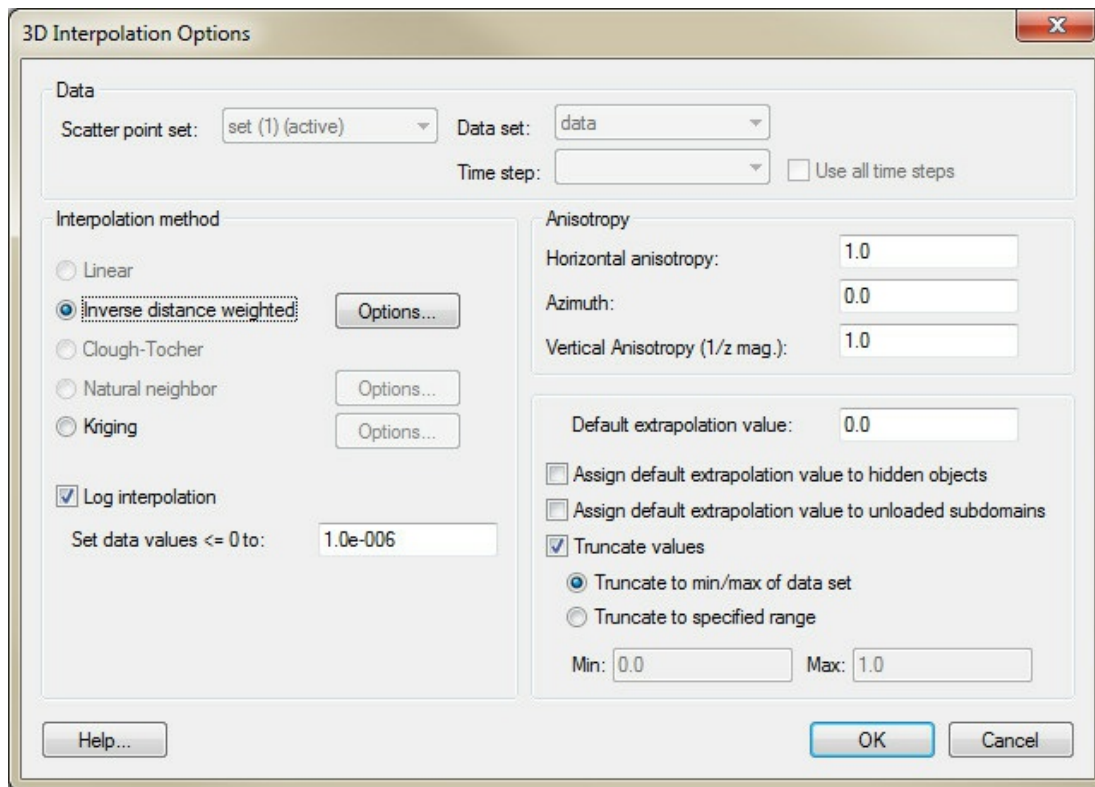

The 3D Interpolation Options dialog.

3D scatter point sets are used for interpolation to other data types such as grids and meshes. Interpolation is useful for such tasks as isosurface rendering or setting up input data for a model. Since no interpolation scheme is superior in all cases, several interpolation techniques are provided in GMS.

The basic approach to performing an interpolation is to select an appropriate interpolation scheme and interpolation parameters, and then interpolate to the desired object using one of the interpolation commands (to 3D grid, to 3D mesh, etc.) described below.

The interpolation options are selected using the *3D Interpolation Options* dialog which is accessed through the **Interpolation Options** command in the *Interpolation* menu. Once a set of options is selected, those options are used for all subsequent interpolation commands. The options in the *3D Interpolation Options* dialog are as follows:

Active Dataset

Interpolation is always performed using the active [dataset](#) of the active scatter point set. The active dataset is normally selected in the [Project Explorer](#). The name of the current active dataset is listed at the top of the *3D Interpolation Options* dialog.

If the active dataset is transient then more interpolation options are available.

Steady State vs. Transient Interpolation

If the active dataset happens to be a transient dataset, two options are available:

1. Steady state interpolation can be performed using only the selected time step of the active dataset.
2. Transient interpolation can be performed using all of the time steps.

By default, only the selected time step is used. The time step is shown next to the dataset name at the top of the dialog. All of the time steps can be selected by selecting the *Use all time steps* option next to the *Time step* combo box. If all time steps are chosen, GMS begins with the first time step in the list and repeatedly interpolates from the scatter point set to the target object, one time step at a time, for all of the time steps. As a result, a dataset is created on the target object with a set of time steps matching the time steps on the scatter point set.

When performing transient interpolation with the [kriging](#) option, special care should be taken with regard to the variogram. Since each time step represents a separate set of data, technically, a separate variogram (or set of variograms) should be created for each time step (GMS stores a separate variogram for each step). This can be accomplished by selecting each time step one at a time using the *Time step* combo box at the top of the *Interpolation Options* dialog, and creating a new variogram for each time step.

Interpolation Methods

The following [methods](#) are supported for 3D interpolation in GMS:

- [Inverse Distance Weighted Interpolation](#) – Based on the assumption that the interpolating surface should be influenced most by the nearby points and less by the more distant points.
- [Kriging](#) – Based on the assumption that the parameter being interpolated can be treated as a regionalized variable.

[Log interpolation](#) is also supported.

Anisotropy

Sometimes the data associated with a scatter point set will have directional tendencies. The *Azimuth* and *Horizontal Anisotropy* allow taking into account these tendencies.

Vertical Anisotropy

In 3D, vertical anisotropy is also available. In previous versions of GMS it was possible to enter a Z scale. Vertical anisotropy is 1 over the Z scale. This notation was changed to be consistent with Kriging.

Occasionally, scatter point sets are sampled along vertical traces. In such cases, the distances between scatter points along the vertical traces are an order of magnitude smaller than the distances between scatter points along the horizontal plane. For example, if the scatter point set was obtained from borehole data, the distance between scatter points may be a few centimeters, whereas the distance between boreholes may be several meters. This disparity in scaling causes clustering and can be a source of poor results in some interpolation methods.

The effects of clustering along vertical traces can be minimized using the vertical anisotropy option in the *3D Interpolation Options* dialog. The Z coordinate of each of the scatter points is multiplied by $1 /$ the vertical anisotropy parameter prior to interpolation. Thus, if the vertical anisotropy parameter is less than 1.0, scatter points along the same vertical axis appear farther apart than they really are and scatter points in the same horizontal plane appear closer than they really are. As a result, points in the same horizontal plane are given a higher relative weight than points along the Z axis. This can result in improved accuracy,

especially in cases where the horizontal correlation between scatter points is expected to be greater than the vertical correlation (which is typically the case in soils since soils are deposited in horizontal layers).

Assign default extrapolation value to hidden objects

This option will assign the default extrapolation value to all cells that are hidden using the **Hide** command in the *Display | Visibility* menu option (see [Display Menu](#)).

Truncation

When interpolating a set of values, it is sometimes useful to limit the interpolated values to lie between a minimum and maximum value. For example, when interpolating contaminant concentrations, a negative value of concentration is meaningless. However, many interpolation schemes will produce negative values even if all of the scatter points have positive values. This occurs in areas where the trend in the data is toward a zero value. The interpolation may extend the trend beyond a zero value into the negative range. In such cases it is useful to limit the minimum interpolated value to zero. Interpolated values can be limited to a given range by selecting the *Truncate values* option in the *3D Interpolation Options* dialog.

Related Topics

- [2D Interpolation Options](#)

4.2. Linear

Linear

If the linear interpolation scheme is selected, the data points are first triangulated to form a network of triangles. The equation of the plane defined by the three vertices of a triangle is as follows:

$$Ax + By + Cz + D = 0$$

where A , B , C , and D are computed from the coordinates of the three vertices (x_1, y_1, z_1) , (x_2, y_2, z_2) , and (x_3, y_3, z_3) :

$$A = y_1(z_2 - z_3) + y_2(z_3 - z_1) + y_3(z_1 - z_2)$$

$$B = z_1(x_2 - x_3) + z_2(x_3 - x_1) + z_3(x_1 - x_2)$$

$$C = x_1(y_2 - y_3) + x_2(y_3 - y_1) + x_3(y_1 - y_2)$$

$$D = -Ax_1 - By_1 - Cz_1$$

The plane equation can also be written as:

$$z = f(x, y) = -\frac{A}{C}x - \frac{B}{C}y - \frac{D}{C}$$

which is the form of the plane equation used to compute the elevation at any point on the triangle.

Since the network of triangles only covers the convex hull of the point data, extrapolation beyond the convex hull is not possible with the linear interpolation scheme. Any points outside the convex hull of the point data are assigned the default extrapolation value entered at the bottom of the *Interpolation Options* dialog. The figure below shows a network of triangles created from point data.

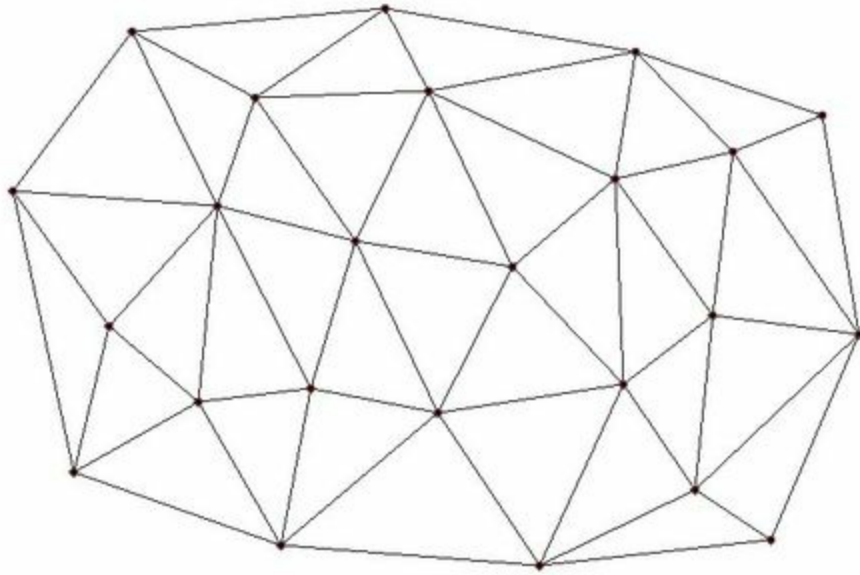

Network of triangles.

See also

- [Interpolation](#)
- [2D Scatter Point Module](#)

4.3. Inverse Distance Weighted

Inverse Distance Weighted

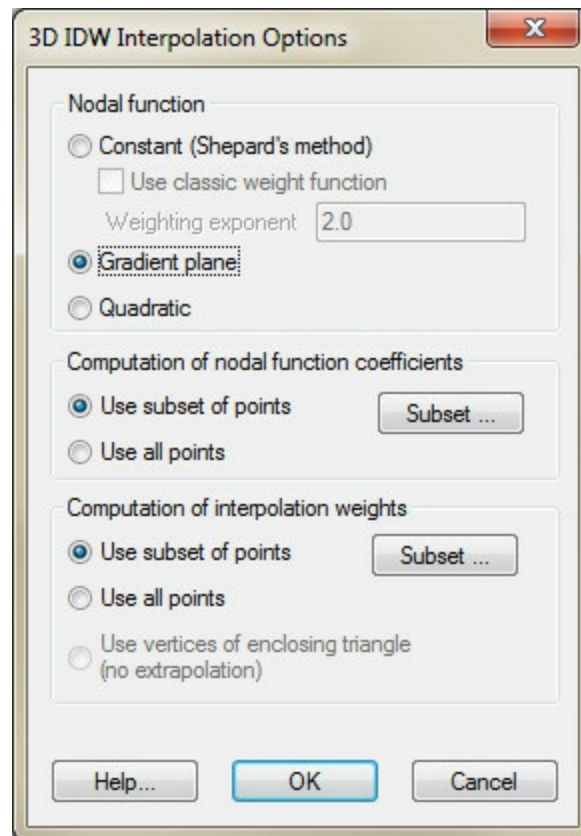

An example of the 3D IDW Interpolation Options dialog.

One of the most commonly used techniques for interpolation of point data is inverse distance weighted (IDW) interpolation. Inverse distance weighted methods are based on the assumption that the interpolating surface should be influenced most by the nearby points and less by the more distant points. The interpolated surface is a weighted average of the point data; the weight assigned to each point diminishes as the distance to the interpolation location increases. Several options are available for inverse distance weighted interpolation. The options are selected using the *IDW Interpolation Options* dialog. This dialog is accessed through the **Options** button next to the Inverse distance weighted item in the *Interpolation Options* dialog.

The options in the dialog are as follows:

- **Constant Nodal Functions (Shepard's Method)** – The simplest form of inverse distance

weighted interpolation. Includes the option to use classic weight function by enter a weighting exponent.

- [Gradient Plane Nodal Functions](#) – Variation of Shepard's method with nodal functions or individual functions defined at each point
- [Quadratic Nodal Functions](#) – Makes use of quadratic polynomials to constrain nodal functions.
- [Subset Definition](#) – Uses a subset of the data points in the computation of the nodal function coefficients and in the computation of the interpolation weights.

Shepard's Method

The simplest form of inverse distance weighted interpolation is the constant nodal function sometimes called the "Shepard's method" (Shepard 1968). The equation used is as follows:

$$F(x, y) = \sum_{i=1}^n w_i f_i$$

where n is the number of points used to interpolate, f_i are the prescribed function values at the points (e.g., the dataset values), and w_i are the weight functions assigned to each point. The classical form of the weight function is:

$$w_i = \frac{h_i^{-p}}{\sum_{j=1}^n h_j^{-p}}$$

where p is an arbitrary positive real number called the weighting exponent and is defaulted to 2. The weighting exponent can be modified by turning on the *Use classic weight function* option. h_i is the distance from the point to the interpolation location or

$$h_i = \sqrt{(x - x_i)^2 + (y - y_i)^2}$$

where (x, y) are the coordinates of the interpolation location and (x_i, y_i) are the coordinates of each point. The weight function varies from a value of unity at the point to a value approaching zero as the distance from the point increases. The weight functions are normalized so that the weights sum to unity.

Although the weight function shown above is the classical form of the weight function in inverse distance weighted interpolation, the following equation is used in GMS:

$$w_i = \frac{\left[\frac{R - h_i}{R h_i} \right]^2}{\sum_{j=1}^n \left[\frac{R - h_j}{R h_j} \right]^2}$$

where h_i is the distance from the interpolation location to the point i , R is the distance from the interpolation location to the most distant point, and n is the total number of points. This equation has been found to give superior results to the classical equation (Franke & Nielson, 1980).

The weight function is a function of Euclidean distance and is radially symmetric about each point. As a result, the interpolating surface is somewhat symmetric about each point and tends toward the mean value of the point data between the points. Shepard's method has been used extensively because of its simplicity.

3D Interpolation

The 3D equations for Shepard's method are identical to the 2D equations except that the distances are computed using:

$$h_i = \sqrt{(x - x_i)^2 + (y - y_i)^2 + (z - z_i)^2}$$

where (x,y,z) are the coordinates of the interpolation location and (x_i, y_i, z_i) are the coordinates of each point.

Related Topics

- [Inverse Distance Weighted](#)

Gradient Plane Nodal Functions

A limitation of [Shepard's method](#) is that the interpolating surface is a simple weighted average of the data values of the points; the surface is constrained to lie between the minimum and maximum data values. In other words, the surface does not infer local maxima or minima implicit in the data values. This problem can be overcome by generalizing the basic form of the equation for Shepard's method in the following manner:

$$F(x, y) = \sum_{i=1}^n w_i Q_i(x, y)$$

where Q_i are nodal functions or individual functions defined at each point (Franke 1982; Watson & Philip 1985). The value of an interpolation location is calculated as the weighted average of the values of the nodal functions at that location. The standard form of Shepard's method can be thought of as a special case where horizontal planes (constants) are used for the nodal functions. The nodal functions can be sloping planes that pass through the data point. The equation for the plane is as follows:

$$Q_i(x, y) = f_x(x - x_i) + f_y(y - y_i) + f_i$$

where f_x and f_y are partial derivatives at the data point that have been previously estimated based on the geometry of the surrounding points. Gradients are estimated in GMS by computing the gradient at each point as the average of the gradients of nearest n points.

The planes represented by the above equation are sometimes called "gradient planes". By averaging planes rather than constant values at each point, the resulting surface infers extremities and is asymptotic to the gradient plane at the point rather than forming a flat plateau at the point.

3D Interpolation

The 3D equivalent of a gradient plane is a gradient hyperplane. The equation of a gradient hyperplane is as follows:

$$Q_i(x, y, z) = f_x(x - x_i) + f_y(y - y_i) + f_z(z - z_i) + f_i$$

where f_x , f_y , and f_z are partial derivatives at the point that are estimated based on the geometry of the surrounding points. The gradients are found using a regression analysis which constrains the hyperplane to the point and approximates the nearby points in a least squares sense. At least five non-coplanar points must be used.

Related Topics

- [Inverse Distance Weighted](#)

Quadratic Nodal Functions

The nodal functions used in inverse distance weighted interpolation can be higher degree polynomial functions constrained to pass through the data points and approximate the nearby points in a least squares manner. Quadratic polynomials have been found to work well in many cases (Franke & Nielson 1980; Franke 1982). The resulting surface reproduces local variations implicit in the dataset, is smooth, and approximates the quadratic nodal functions near the data points. The equation used for the quadratic nodal function centered at point k is as follows:

$$Q_k(x, y) = a_{k1} + a_{k2}(x - x_k) + a_{k3}(y - y_k) + a_{k4}(x - x_k)^2 + a_{k5}(x - x_k)(y - y_k) + a_{k6}(y - y_k)^2$$

To define the function, the six coefficients $a_{k1}..a_{k6}$ must be found. Since the function is centered at the point k and passes through point k , we know beforehand that $a_{k1} = f_k$ where f_k is the function value at point k . The equation simplifies to:

$$Q_k(x, y) = f_k + a_{k2}(x - x_k) + a_{k3}(y - y_k) + a_{k4}(x - x_k)^2 + a_{k5}(x - x_k)(y - y_k) + a_{k6}(y - y_k)^2$$

Now there are only five unknown coefficients. The coefficients are found by fitting the quadratic to the nearest NQ data points using a weighted least squares approach. In order for the matrix equation used to solve for the coefficients to be stable, there should be at least five data points in the set.

3D Interpolation

For 3D interpolation, the following equation is added to the quadratic nodal function:

$$+ a_{k5}(x - x_k)(y - y_k) + a_{k6}(x - x_k)(z - z_k) + a_{k7}(y - y_k)(z - z_k)$$

To define the function, the ten coefficients $a_{k1}..a_{k10}$ must be found. Since the function is centered on point k , we know that $a_{k1} = f_k$ where f_k is the data value at point k . The equation simplifies to:

$$Q_k(x, y, z) = f_k + a_{k2}(x - x_k) + a_{k3}(y - y_k) + a_{k4}(z - z_k)$$

Now there are only nine unknown coefficients. The coefficients are found by fitting the quadratic to a subset of the neighboring data points in a weighted least squares fashion. In

order for the matrix equation used to be solve for the coefficients to be stable, there should be at least ten non-coplanar data points in the set.

Related Topics

- [Inverse Distance Weighted](#)

Subset Definition

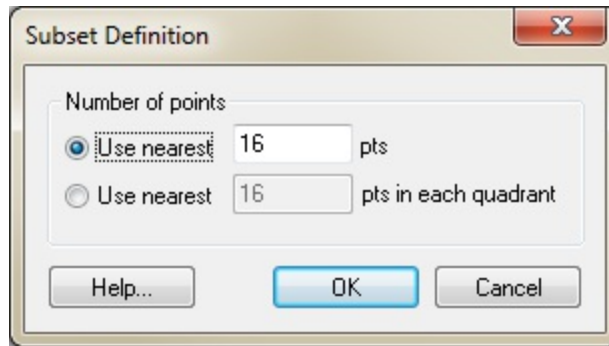

The Subset Definition dialog.

In the [IDW Interpolation Options](#) dialog, an option is available for using a subset of the data points (as opposed to all of the available data points) in the computation of the nodal function coefficients and in the computation of the interpolation weights. Using a subset of the data points drops distant points from consideration since they are unlikely to have a large influence on the nodal function or on the interpolation weights. In addition, using a subset can speed up the computations since less points are involved.

If the *Use subset of points* option is chosen, the **Subsets** button can be used to bring up the *Subset Definition* dialog. Two options are available for defining which points are included in the subset. In the first approach, only the nearest N points are used. In the second approach, only the nearest N points in each quadrant are used as illustrated in the figure below. The second approach may give better results if the data points tend to be clustered.

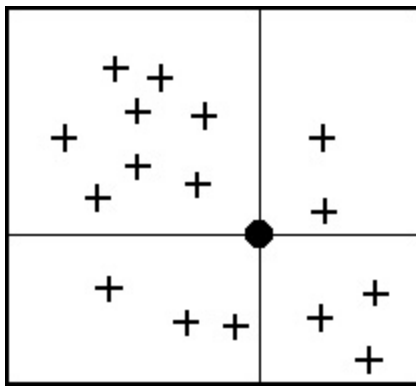

The four quadrants surrounding an interpolation point.

Related Topics

- [Inverse Distance Weighted](#)

Computation of Interpolation Weights

When computing the interpolation weights, three options are available for determining which points are included in the subset of points used to compute the weights and perform the interpolation: subset, all points, and enclosing triangle.

Subset of Points

If the **Use subset of points** option is chosen, the [Subset Definition](#) dialog can be used to define a local subset of points.

All Points

If the **Use all points** option is chosen, a weight is computed for each point and all points are used in the interpolation.

Enclosing Triangle

The *Use vertices of enclosing triangle* method makes the interpolation process a local scheme by taking advantage of TIN topology (Franke & Nielson, 1980). With this technique, the subset of points used for interpolation consists of the three vertices of the triangle containing the interpolation point. The weight function or blending function assigned to each scatter point is a cubic S-shaped function as shown in part a of the figure below. The fact that the slope of the weight function tends to unity at its limits ensures that the slope of the interpolating surface is continuous across triangle boundaries.

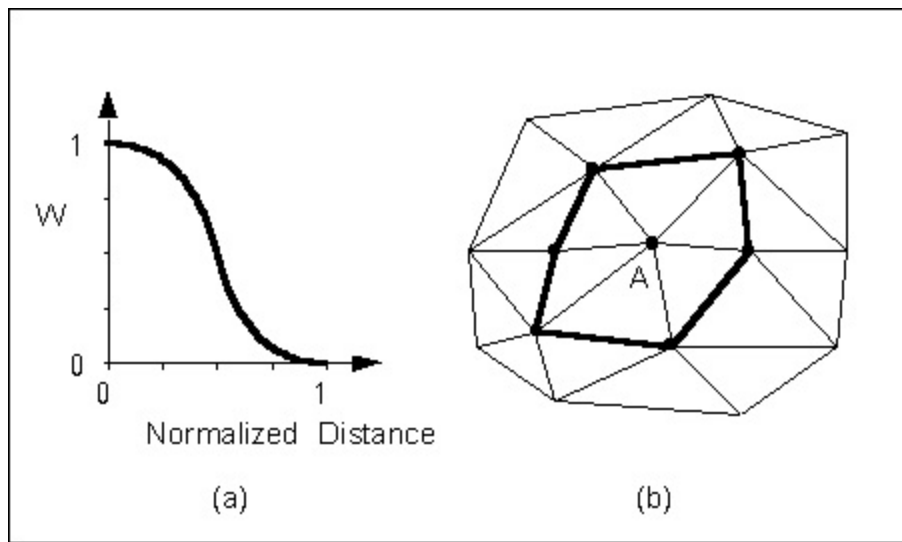

(a) S-shaped weight function and (b) Delaunay point group for point A.

The influence of the weight function extends over the limits of the Delaunay point group of the scatter point. The Delaunay point group is the "natural neighbors" of the scatter point, and the perimeter of the group is made up of the outer edges of the triangles that are connected to the scatter point as shown in part b. The weight function varies from a weight of unity at the scatter point to zero at the perimeter of the group. For every interpolation point in the interior of a triangle there are three nonzero weight functions (the weight functions of the three vertices of the triangle). For a triangle T with vertices $i, j, & k$, the weights for each vertex are determined as follows:

$$w_i(x, y) = b_i^2 (3 - 2b_i) + 3 \frac{b_i^2 b_j b_k}{b_i b_j + b_i b_k + b_j b_k} \left\{ b_j \left[\frac{\|e_i\|^2 + \|e_k\|^2 - \|e_j\|^2}{\|e_k\|^2} \right] + b_k \left[\frac{\|e_i\|^2 + \|e_j\|^2 - \|e_k\|^2}{\|e_j\|^2} \right] \right\}$$

Where $\|e_i\|$ is the length of the edge opposite vertex i , and b_i, b_j, b_k are the area coordinates of the point (x, y) with respect to triangle T .

Area coordinates are coordinates that describe the position of a point within the interior of a triangle relative to the vertices of the triangle. The coordinates are based solely on the geometry of the triangle. Area coordinates are sometimes called "barycentric coordinates." The relative magnitude of the coordinates corresponds to area ratios as shown below:

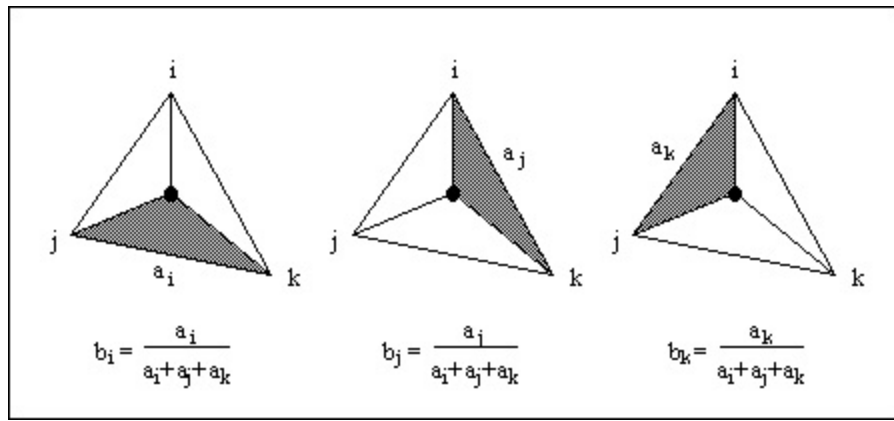

Barycentric coordinates for a point in a triangle.

The XY coordinates of the interior point can be written in terms of the XY coordinates of the vertices using the area coordinates as follows:

$$x = b_i x_i + b_j x_j + b_k x_k$$

$$y = b_i y_i + b_j y_j + b_k y_k$$

$$1.0 = b_i + b_j + b_k$$

Solving the above equations for b_i , b_j , and b_k yields:

$$b_i = \frac{1}{2A} [(x_j y_k - x_k y_j) + (y_j - y_k)x + (x_k - x_j)y]$$

$$b_j = \frac{1}{2A} [(x_k y_i - x_i y_k) + (y_k - y_i)x + (x_i - x_k)y]$$

$$b_k = \frac{1}{2A} [(x_i y_j - x_j y_i) + (y_i - y_j)x + (x_j - x_i)y]$$

$$A = \frac{1}{2} (x_i y_j + x_j y_k + x_k y_i - y_i x_j - y_j x_k - y_k x_i)$$

Using the weight functions defined above, the interpolating surface at points inside a triangle is computed as:

$$F(x, y) = w_i(x, y)Q_i(x, y) + w_j(x, y)Q_j(x, y) + w_k(x, y)Q_k(x, y)$$

where w_i , w_j , and w_k are the weight functions and Q_i , Q_j , and Q_k are the nodal functions for the three vertices of the triangle.

4.4. Clough-Tocher

Clough-Tocher

The Clough-Tocher interpolation technique is often referred to in the literature as a finite element method because it has origins in the finite element method of numerical analysis. Before any points are interpolated, the points are first triangulated to form a network of triangles. A bivariate polynomial is defined over each triangle, creating a surface made up of a series of triangular Clough-Tocher surface patches.

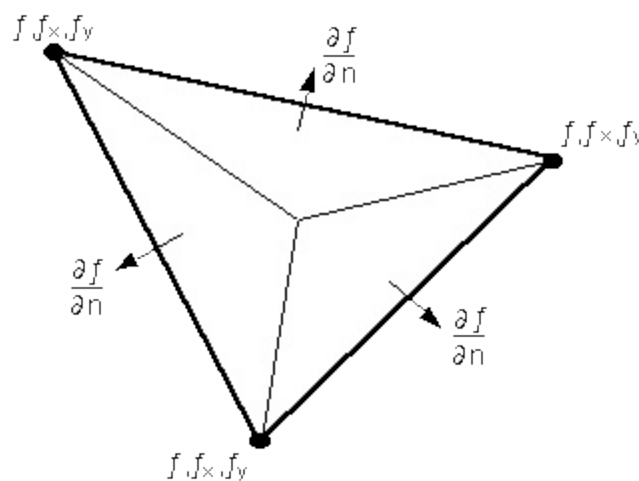

The twelve parameters used to define the Clough-Tocher triangle

The Clough-Tocher patch is a cubic polynomial defined by twelve parameters shown in the following figure: the function values, f , and the first derivatives, f_x and f_y , at each vertex, and the normal derivatives, $\frac{\partial f}{\partial n}$, at the midpoint of the three edges in the triangle (Clough & Tocher, 1965; Lancaster & Salkauskas, 1986). The first derivatives at the vertices are estimated using the average slopes of the surrounding triangles. The element is partitioned into three subelements along seams defined by the centroid and the vertices of the triangle.

A complete cubic polynomial of the form:

$$F(x, y) = \sum_{j=0}^{3-i} c_{ij} x^i y^j$$

is created over each sub-triangle with slope continuity across the seams and across the

boundaries of the triangle. Second derivative continuity is not maintained across the seams of the triangle.

Since the Clough-Tocher scheme is a local scheme, it has the advantage of speed. Even very large sets of points can be interpolated quickly. It also tends to give a smooth interpolating surface which brings out local trends in the dataset quite accurately.

Since the network of triangles only covers the convex hull of the points, extrapolation beyond the convex hull is not possible with the Clough-Tocher interpolation scheme. Any points outside the convex hull of the points are assigned the default extrapolation value entered at the bottom of the *Interpolation Options* dialog.

4.5. Natural Neighbor

Natural Neighbor

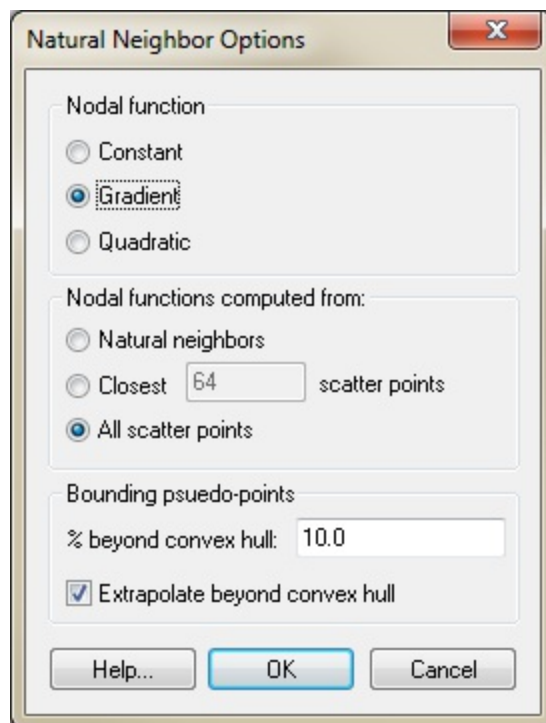

The Natural Neighbor Options dialog

The basic equation used in natural neighbor interpolation is identical to the one used in [IDW interpolation](#):

$$F(x, y) = \sum_{i=1}^n w_i f_i$$

As with IDW interpolation, the nodal functions can be either constants, gradient planes, or quadratics. The nodal function can be selected using the *Natural Neighbor Interpolation Options* dialog. The difference between IDW interpolation and natural neighbor interpolation is the method used to compute the weights and the method used to select the subset of point data used for interpolation.

Natural neighbor interpolation is based on the Thiessen polygon network of the point data. The Thiessen polygon network can be constructed from the Delaunay triangulation of a set of points. A Delaunay triangulation is a network of triangles that has been constructed so that the [Delaunay criterion](#) has been satisfied.

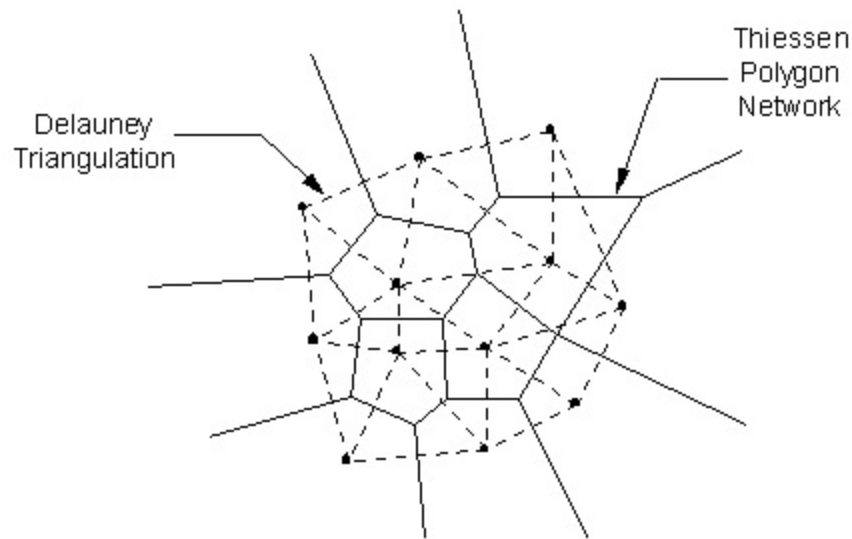

Delaunay triangulation and corresponding Thiessen polygon network for a set points.

There is one Thiessen polygon in the network for each point. The polygon encloses the area that is closer to the enclosed point than any other point. The polygons in the interior of the points are closed polygons and the polygons on the convex hull of the points are open polygons.

Each Thiessen polygon is constructed using the circumcircles of the triangles resulting from a Delaunay triangulation of the points. The vertices of the Thiessen polygons correspond to the centroids of the circumcircles of the triangles.

Local Coordinates

The weights used in natural neighbor interpolation are based on the concept of local coordinates. Local coordinates define the "neighborliness" or amount of influence any point will have on the computed value at the interpolation location. This neighborliness is entirely dependent on the area of influence of the Thiessen polygons of the surrounding points.

To define the local coordinates for the interpolation location, P_n , the area of all Thiessen polygons in the network must be known. Temporarily inserting P_n into the network of triangles causes the corresponding Thiessen network to change, resulting in new Thiessen areas for the polygons in the neighborhood of P_n .

The concept of local coordinates is shown graphically in the following figure. Points 1-10 are data points and P_n is an interpolation location where some value associated with points 1-10 is to be interpolated. The dashed lines show the edges of the Thiessen network before P_n is temporarily inserted into triangle network and the solid lines show the edges of the Thiessen network after P_n is inserted.

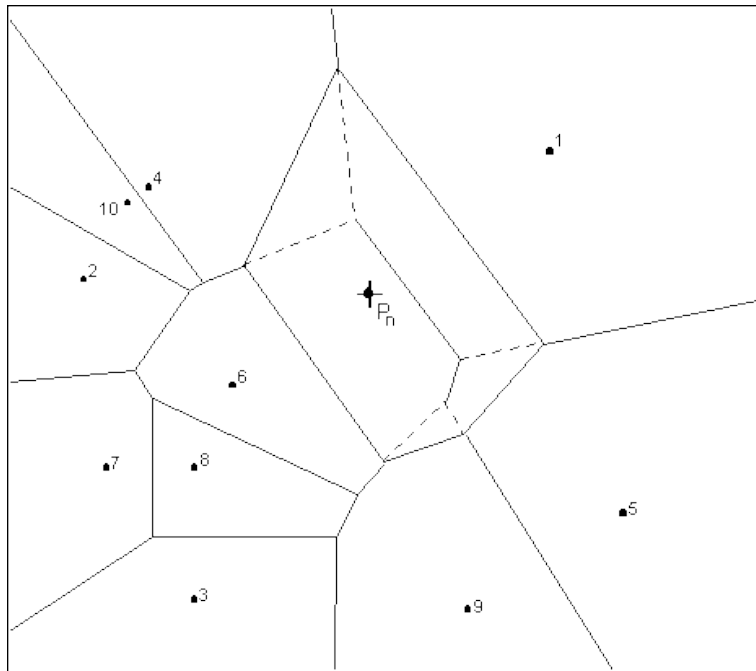

Overlapping Thiessen polygon areas used in computation of local coordinates.

Only those points whose Thiessen polygons have been altered by the temporary insertion of P_n are included in the subset of points used to interpolate a value at P_n . In this case, only points 1, 4, 5, 6, & 9 are used. The local coordinate for each of these points with respect to P_n is defined as the area shared by the Thiessen polygon defined by point P_n and the Thiessen polygon defined by each point before point P_n is added. The greater the common area, the larger the resulting local coordinate, and the larger the influence or weight the point has on the interpolated value at P_n .

If defining $k(n)$ as the Thiessen polygon area of P_n and $k_m(n)$ as the difference in the Thiessen polygon area of a neighboring scatter point, P_m , before and after P_n is inserted, then the local coordinate $l_m(n)$ is defined as:

$$\lambda_m(n) = \frac{\kappa_m(n)}{\kappa(n)}$$

The local coordinate $I_m(n)$ varies between zero and unity and is directly used as the weight, $w_m(n)$, in the interpolation equation. If P_n is at precisely the same location as P_m , then the Thiessen polygon areas for P_n and P_m are identical and $I_m(n)$ has a value of unity. In general, the greater the relative distance P_m is from P_n , the smaller its influence on the final interpolated value.

Extrapolation

As shown in the figure above, the Thiessen polygons for data points on the perimeter of the triangle network are open-ended polygons. Since such polygons have an infinite area, they cannot be used directly for natural neighbor interpolation. Thus, a special approach is used to facilitate extrapolation with the natural neighbor scheme. Prior to interpolation, the X and Y boundaries of the object being interpolated to (grid, mesh, etc.) are determined and a box is placed around the object whose boundaries exceed the limits of the object by approximately 10% (this value can be modified). Four temporary "pseudo points" are created at the four corners of the box. The inverse distance weighted interpolation scheme with gradient plane nodal functions is then used to estimate a data value at the pseudo-points. From that point on, the pseudo-points with the extrapolated values are included with the actual data points in the interpolation process. Consequently, all of the points being interpolated to are guaranteed to be within the convex hull of the data points. Once the interpolation is complete, the pseudo-points are discarded.

See also

- [Interpolation](#)
- [2D Scatter Point Module](#)

4.6. Kriging

Kriging

Kriging is a method of interpolation named after a South African mining engineer named D. G. Krige who developed the technique in an attempt to more accurately predict ore reserves. Over the past several decades kriging has become a fundamental tool in the field of geostatistics.

Kriging is based on the assumption that the parameter being interpolated can be treated as a regionalized variable. A regionalized variable is intermediate between a truly random variable and a completely deterministic variable in that it varies in a continuous manner from one location to the next and therefore points that are near each other have a certain degree of spatial correlation, but points that are widely separated are statistically independent (Davis, 1986). Kriging is a set of linear regression routines which minimize estimation variance from a predefined covariance model.

The kriging routines implemented in GMS are based on the Geostatistical Software Library (GSLIB) routines published by Deutsch and Journel (1992). Since kriging is a rather complex interpolation technique and includes numerous options, a complete description of kriging is beyond the scope of this reference manual. It is strongly encouraged to refer the GSLIB textbook for more information:

- Deutsch, C.V., & A.G. Journel. *GSLIB: Geostatistical Software Library and User's Guide*. Oxford University Press, New York, 1992.

Other good references on kriging include:

- Royle, A.G., F.L. Clausen, & P. Frederiksen. Practical Universal Kriging and Automatic Contouring. *Geo-Processing*, Vol. 1, No. 4, 1981.
- Davis, J.C. *Statistics and Data Analysis in Geology*. John Wiley & Sons, New York, 1986.
- Lam, N.S. Spatial Interpolation Methods: A Review. *The American Cartographer*. Vol. 10, No. 2, 1983.

- Heine, G.W., A Controlled Study of Some Two-Dimensional Interpolation Methods, *COGS Computer Contributions*, Vol. 2, No. 2.
- Olea, T.A., Optimal Contour Mapping using Universal Kriging. *J. Geophys. Research*, Vol. 79, No. 5, 1974.
- Journel, A.G., & Huijbregts, C.J. *Mining Geostatistics*. Academic Press, New York, NY, 1978.

A powerful set of kriging techniques with varying degrees of sophistication have been implemented in GMS. The selection of the Kriging method and the definition of the variograms are accomplished using the [Kriging Options](#) dialog. There are several differences between 2D and [3D Kriging](#). The supported techniques include:

Ordinary Kriging

The first step in ordinary kriging is to construct a variogram from the scatter point set to be interpolated. A variogram consists of two parts: an experimental variogram and a model variogram. Suppose that the value to be interpolated is referred to as f . The experimental variogram is found by calculating the variance (g) of each point in the set with respect to each of the other points and plotting the variances versus distance (h) between the points. Several formulas can be used to compute the variance, but it is typically computed as one half the difference in f squared.

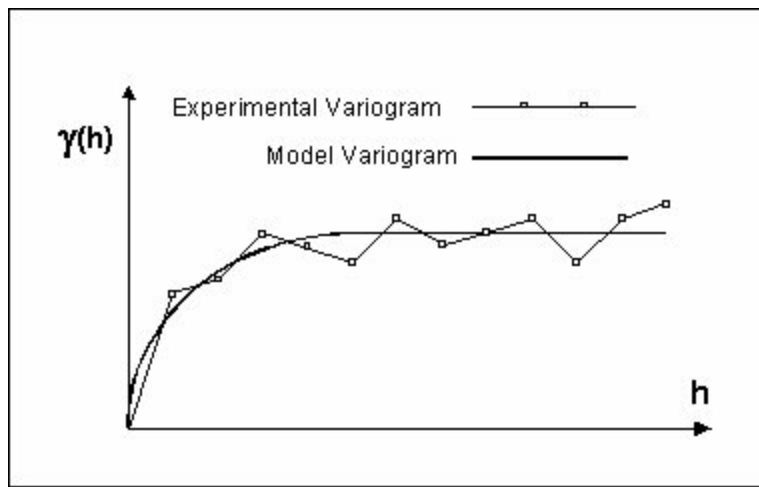

Experimental and model variogram used in Kriging

Once the experimental variogram is computed, the next step is to define a model variogram. A model variogram is a simple mathematical function that models the trend in the experimental variogram.

As can be seen in the above figure, the shape of the variogram indicates that at small separation distances, the variance in f is small. In other words, points that are close together have similar f values. After a certain level of separation, the variance in the f values becomes somewhat random and the model variogram flattens out to a value corresponding to the average variance.

Once the model variogram is constructed, it is used to compute the weights used in kriging. The basic equation used in ordinary kriging is as follows:

$$F(x, y) = \sum_{i=1}^n w_i f_i$$

Where n is the number of scatter points in the set, f_i are the values of the scatter points, and w_i are weights assigned to each scatter point.

This equation is essentially the same as the equation used for inverse distance weighted interpolation (equation 9.8) except that rather than using weights based on an arbitrary function of distance, the weights used in kriging are based on the model variogram. For example, to interpolate at a point P based on the surrounding points P_1 , P_2 , and P_3 , the weights w_1 , w_2 , and w_3 must be found. The weights are found through the solution of the simultaneous equations:

$$w_1S(d_{11}) + w_2S(d_{12}) + w_3S(d_{13}) = S(d_{1p})$$

$$w_1S(d_{21}) + w_2S(d_{22}) + w_3S(d_{23}) = S(d_{2p})$$

$$w_1S(d_{31}) + w_2S(d_{32}) + w_3S(d_{33}) = S(d_{3p})$$

where $S(d_{ij})$ is the model variogram evaluated at a distance equal to the distance between points i and j . For example, $S(d_{1p})$ is the model variogram evaluated at a distance equal to the separation of points P_1 and P . Since it is necessary that the weights sum to unity, a fourth equation is added:

$$w_1 + w_2 + w_3 = 1.0$$

Since there are now four equations and three unknowns, a slack variable, λ , is added to the equation set. The final set of equations is as follows:

$$w_1S(d_{11}) + w_2S(d_{12}) + w_3S(d_{13}) + \lambda = S(d_{1p})$$

$$w_1S(d_{21}) + w_2S(d_{22}) + w_3S(d_{23}) + \lambda = S(d_{2p})$$

$$w_1S(d_{31}) + w_2S(d_{32}) + w_3S(d_{33}) + \lambda = S(d_{3p})$$

$$w_1 + w_2 + w_3 + 0 = 1.0$$

The equations are then solved for the weights w_1 , w_2 , and w_3 . The f value of the interpolation point is then calculated as:

$$f_p = w_1f_1 + w_2f_2 + w_3f_3$$

By using the variogram in this fashion to compute the weights, the expected estimation error is minimized in a least squares sense. For this reason, kriging is sometimes said to produce the best linear unbiased estimate. However, minimizing the expected error in a least squared sense is not always the most important criteria and in some cases, other interpolation schemes give more appropriate results (Philip & Watson, 1986).

An important feature of kriging is that the variogram can be used to calculate the expected error of estimation at each interpolation point since the estimation error is a function of the distance to surrounding scatter points. The estimation variance can be calculated as:

$$s_z^2 = w_1S(d_{1p}) + w_2S(d_{2p}) + w_3S(d_{3p}) + \lambda$$

When interpolating to an object using the kriging method, an estimation variance dataset is always produced along with the interpolated dataset. As a result, a contour or isosurface plot of estimation variance can be generated on the target mesh or grid.

Simple Kriging

Simple kriging is similar to ordinary kriging except that the following equation is not added to the set of equations:

$$w_1 + w_2 + w_3 = 1.0$$

and the weights do not sum to unity. Simple kriging uses the average of the entire data set while ordinary kriging uses a local average (the average of the scatter points in the kriging subset for a particular interpolation point). As a result, simple kriging can be less accurate than ordinary kriging, but it generally produces a result that is "smoother" and more aesthetically pleasing.

Universal Kriging

One of the assumptions made in kriging is that the data being estimated are stationary. That is, when moving from one region to the next in the scatter point set, the average value of the scatter points is relatively constant. Whenever there is a significant spatial trend in the data values such as a sloping surface or a localized flat region, this assumption is violated. In such cases, the stationary condition can be temporarily imposed on the data by use of a [drift](#) term. The drift is a simple polynomial function that models the average value of the scatter points. The residual is the difference between the drift and the actual values of the scatter points. Since the residuals should be stationary, kriging is performed on the residuals and the interpolated residuals are added to the drift to compute the estimated values. Using a drift in this fashion is often called "universal kriging."

See also

- [Interpolation](#)
- [Kriging Options](#)
- [3D Kriging](#)
- [2D Scatter Point Module](#)
- [3D Scatter Point Module](#)

Kriging Options

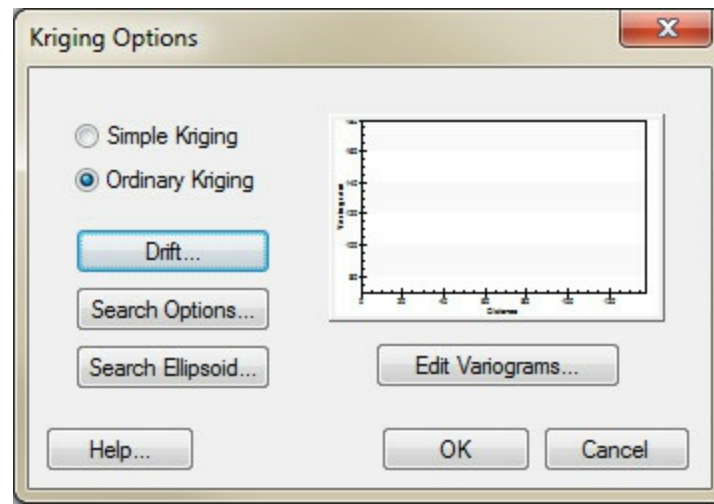

The Kriging Options dialog.

The kriging options can be edited with the *Kriging Options* dialog. This dialog is reached through the [3D Interpolation Options](#) dialog. The options in the *Kriging Options* dialog are as follows:

Kriging Method

The pull-down list in the kriging method section is used to select which kriging technique is used. The options are *Simple Kriging* or *Ordinary Kriging*. (See [Kriging](#))

Drift

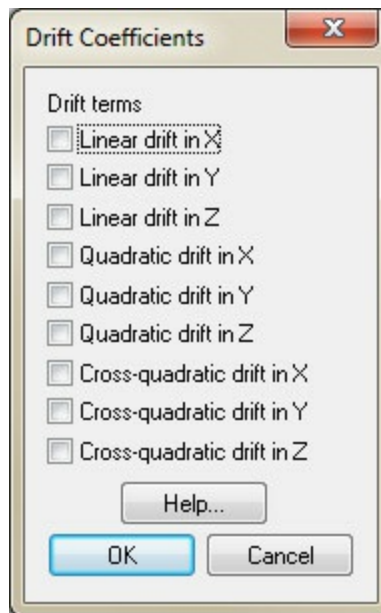

The Drift Coefficients dialog.

When performing [Universal Kriging](#), a drift function should be defined. The **Drift** button brings up the *Drift Coefficients* dialog. Each of the toggles in the dialog represents a single component of the polynomial equation defining the drift. Initially, all of the toggles are off by default. Turning on coefficients enables universal kriging and defines the drift polynomial. For example, to use a planar drift function, only the linear terms should be used.

Search Options

The **Search Options** button brings up the *Search Options* dialog. The *Minimum* and *Maximum* values in the *Number of points to use for kriging* controls how many of the points found in the search radius are actually used in the kriging calculations. If fewer than the minimum value are found, a default value (-999) is assigned to the interpolation point. If greater than the maximum value is found, the closest points are used.

The input data cutoff values are used to screen out data values outside the specified range. Points with values outside this range are ignored.

If the *Octant* option is selected in the search type section, a maximum of N points in each of the eight octants (for 2D a quadrant is used) surrounding the interpolation point are used in the calculations. This method results in better performance with clustered data. If the Normal method is selected, the octant approach is not used.

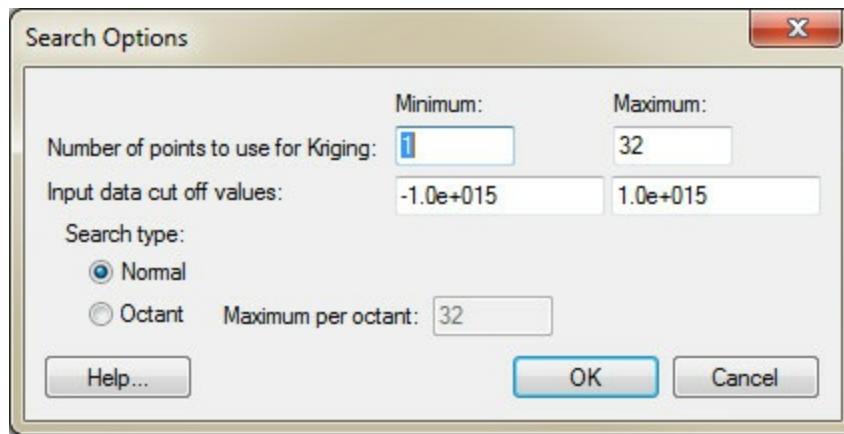

The Search Options dialog.

Search Ellipsoid

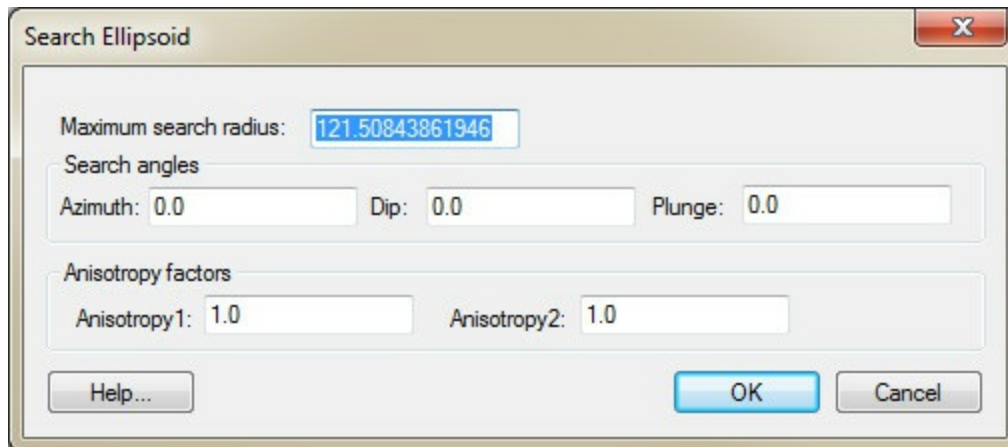

The Search Ellipsoid dialog.

The **Search Ellipsoid** button brings up the *Search Ellipsoid* dialog. When a value is interpolated to an interpolation point, only a subset of the scatter points in the vicinity of the interpolation point are used in the calculations. The items in the *Search Ellipsoid* dialog control the shape of a "search space" surrounding the interpolation point. Only points in this search space are considered candidates for use in the kriging calculations.

By default, the search space is a circle (sphere in 3D) centered at the point with a radius defined by the Maximum search radius item. For problems exhibiting anisotropy, the search space can be transformed to an ellipse (ellipsoid in 3D). The anis1 factor and the azimuth angle control the shape and orientation of the ellipse. The azimuth represents the rotation of

the major principal axis clockwise from the +y axis. The anis1 factor represents the ratio of the search radius along the minor principal axis relative to the search radius (the maximum radius) in the major principal direction. In most cases, the anis1 factor and the azimuth angle should match the anis factor and azimuth angle defined in the [Variogram Editor](#).

Editing Variograms

Regardless of which kriging method is selected, a model variogram must be constructed prior to interpolating the values from the scatter points to the target object. In some cases, multiple variograms must be defined. The basic steps involved in constructing a model variogram are to first build an experimental variogram and then construct a model variogram that matches the experimental variogram. Variograms are constructed using the [Variogram Editor](#). The *Variogram Editor* is activated by selecting the **Edit Variogram** button in the *Kriging Options* dialog.

See also

- [Kriging](#)

3D Kriging

3D kriging is almost identical to 2D kriging. All of the basic kriging options, including simple kriging and ordinary kriging. (See [Kriging](#))

2D vs. 3D

There are several differences in the 2D and the 3D versions of kriging. First of all, if the drift option is turned on, more drift coefficients are available. In the *Search Options* dialog, an octant searching scheme can be selected. A number is entered which represents the maximum number of scatter points from each of the eight octants surrounding the interpolation point to keep in the subset. Limiting the number of points in each octant can give better results when the scatter points are clustered.

Modeling Anisotropy

The main difference between the 3D and 2D versions of kriging is the way anisotropy is treated. The third dimension adds additional angles and factors that must be manipulated. As is the case with 2D kriging, the first step in modeling anisotropy is to detect anisotropy using experimental variograms. Anisotropy can be modeled in up to three orthogonal directions. A series of orthogonal variograms are generated at different orientations until the three experimental variograms corresponding to the three principal axes of anisotropy are found. The combination which gives the greatest difference in range for the three experimental variograms corresponds to the principal axes. The axis with the largest range is the major principal axis.

When computing directional experimental variograms in 3D, two angles are used to define the direction vector: azimuth and dip. To define the rotation of a vector, we assume the unrotated vector starts in the +y direction. The azimuth angle is the first angle of rotation and it represents a clockwise rotation in the horizontal plane starting from the +y axis. The dip angle is the second angle of rotation and it represents a downward rotation of the

vector from the horizontal plane. The azimuth and dip angles defined in the *experimental variogram* dialog can be used to define a focused experimental variogram in any direction. Once anisotropy has been detected using the experimental variograms, anisotropy can be modeled with the model variogram using either the directional variogram method or the anisotropy factor method. The simplest method is the directional variogram approach. If the directional variogram approach is used, a separate model variogram is constructed for each of the three orthogonal axes.

If the anisotropy factor method is selected, the azimuth and dip angles corresponding to the major principal axis should be entered into the angle edit fields in the lower left corner of the *Variogram Editor*. These fields also allow a third angle of rotation, the plunge angle, to be specified. The plunge angle represents a rotation or spinning about the direction vector (which is already rotated by the azimuth and dip). The direction of rotation is defined as clockwise looking down the direction vector toward the origin. In most cases, the plunge angle can be left at zero.

Once the angles are entered, the model variogram should then be constructed which fits the experimental variogram corresponding to the major principal direction. The *anis1* and *anis2* parameters in the *Variogram Editor* should then be changed to a value other than unity (the default value). Changing these parameters to a value less than unity causes three curves to be drawn for the model variogram. The second curve corresponds to the original curve with the range parameter multiplied by the *anis1* value. The third curve corresponds to the original curve with the range parameter multiplied by the *anis2* value. The *anis1* parameter should be altered until the second curve fits the experimental variogram corresponding to the second principal axis of anisotropy. If the principal axis is assumed to be the y axis in the unrotated state, this axis is the x axis in the rotated state. The *anis2* parameter should then be altered until the third curve matches the third principal axis of anisotropy (the z axis in the unrotated state). Once the correct anisotropy factors are found, the *Variogram Editor* should be exited and the angles and anisotropy factors should be entered in the *Search Ellipsoid* dialog to define a search ellipsoid that matches the variogram anisotropy.

For further information on modeling anisotropy in 3D, refer to Deutsch and Journel (1992).

See also

- Kriging

Variogram Editor

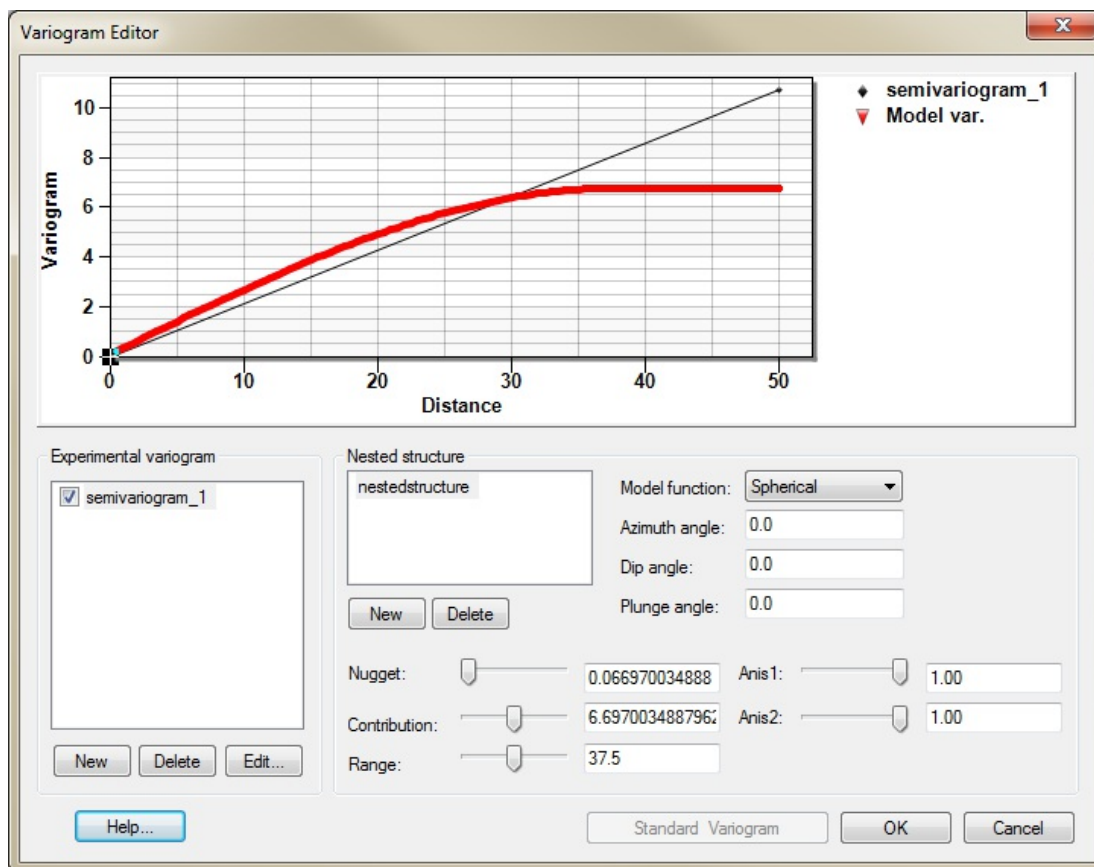

The Variogram Editor dialog

Before interpolating a scatter point set using the Kriging option, a model variogram must be defined. The basic steps involved in constructing a model variogram are to first build an experimental variogram and then construct a model variogram that matches the experimental variogram. This is accomplished using the *Variogram Editor*. The *Variogram Editor* is activated by selecting the **Edit Variogram** button in the *Kriging Options dialog*.

The experimental variograms and the model variogram are plotted in the upper portion of the *Variogram Editor*. The items in the upper right portion of the editor are used to create experimental variograms. The items in the lower half of the editor are used to define the model variogram. In a typical study, several experimental variograms may be constructed and plotted before one is chosen. A model variogram is then designed to fit the chosen

experimental variogram.

Creating Experimental Variograms

A new experimental variogram is computed by selecting the **New** button under the list of experimental variograms. This button brings up the *Experimental Variogram* dialog.

Lags

When computing an experimental variogram, it is impractical to plot a variance for each scatter point with respect to each of the other scatter points. Therefore, distances are subdivided into a number of intervals called lags as illustrated in the following figure. The distance between each pair of scatter points is checked to see which lag interval it lies within. The variances for all pairs of points whose separation distance falls within the same lag interval are averaged. The resulting average is plotted in the experimental variogram vs. the distance corresponding to the lag interval. Therefore, there is one point in the experimental variogram plot for each lag. The lag intervals are defined in the *Experimental Variogram* dialog by entering a total number of lags, a unit lag separation distance, and a lag tolerance. In most cases, the lag tolerance should be one half of the unit lag separation distance; the tolerance can be smaller to allow for data on a pseudo-regular grid. A pair will be included in multiple lags if the tolerance is greater than one-half of the unit lag separation distance.

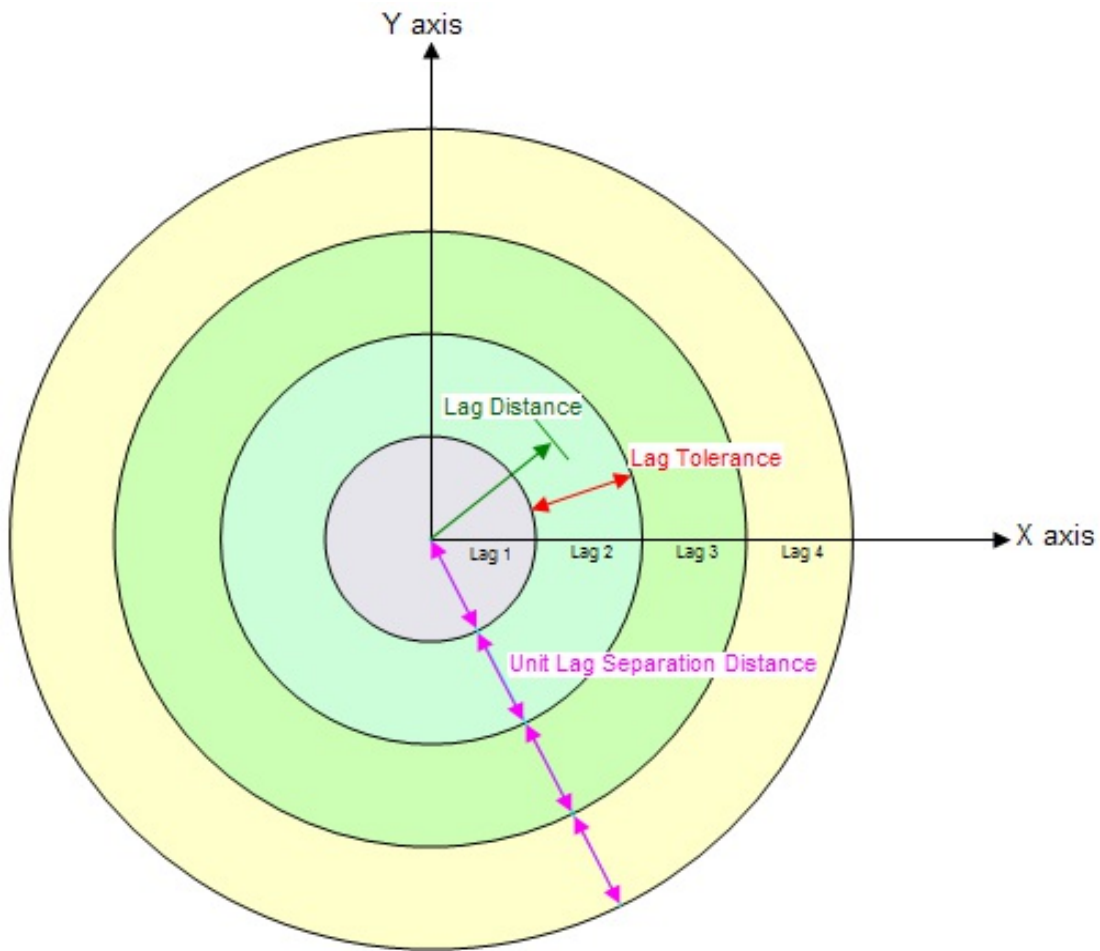

Lag interval illustration for the variogram editor

Semivariogram

The semivariogram is the most common type of variogram. The semivariogram value for a lag interval is computed as:

$$\gamma(h) = \frac{1}{2N} \sum_{i=1}^N (f_{1i} - f_{2i})^2$$

where N is the number of pairs of points whose separation distance falls within the lag interval and f_{1i} and f_{2i} are the values at the head and tail of each pair of points. The head and tail are defined as follows:

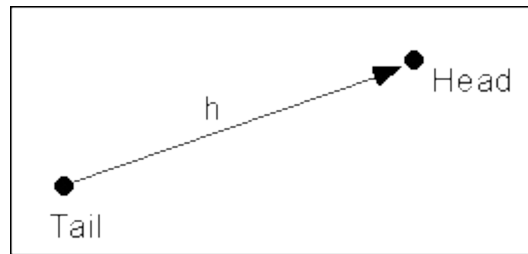

Naming convention for pairs of scatter points

Covariance

The covariance is the traditional covariance used in statistics. The covariance value for a lag interval is computed as:

$$C(h) = \frac{1}{N} \sum_{i=1}^N (f_{2i} f_{1i} - m_{-h} m_{+h})$$

where m_{-h} and m_{+h} are the mean of the head and tail values respectively.

Correlogram

The correlogram is computed by standardizing the covariance by the standard deviation of the head and tail values.

$$\rho(h) = \frac{C(h)}{\sigma_{-h} \sigma_{+h}}$$

where s_{-h} and s_{+h} are the standard deviation of the head and tail values respectively.

General Relative Semivariogram

This variogram is computed by standardizing the semivariogram computed using equation 9.38 by the squared mean of the data values in each lag:

$$\gamma_{GR}(h) = \frac{\gamma(h)}{\left(\frac{m_{-h} + m_{+h}}{2}\right)^2}$$

Pairwise Relative Semivariogram

With this variogram, each pair is normalized by the squared average of the tail and head values.

$$\gamma_{PR}(h) = \frac{1}{2N} \frac{(f_{1i} - f_{2i})^2}{\left[\frac{(f_{1i} - f_{2i})^2}{2}\right]^2}$$

Experience has shown that the general relative and pairwise relative semivariograms are effective in revealing spatial structure and anisotropy when the scatter points are sparse (Deutsch & Journel, 1992). Because of the divisors in equations 9.41 and 9.42, these semivariograms should only be used on positively skewed datasets.

Semivariogram of Logarithms

This variogram is computed by applying equation 9.38 to the natural logarithms of the data values:

$$\gamma_L(h) = \frac{1}{2N} \sum_{i=1}^N (\ln(f_{1i}) - \ln(f_{2i}))^2$$

Semiogram

The semiogram is similar to the traditional semivariogram except that the square root of the absolute difference is used rather than the squared difference:

$$\gamma_R(h) = \frac{1}{2N} \sum_{i=1}^N \sqrt{|f_{1i} - f_{2i}|}$$

Semimadogram

The semimadogram is similar to the traditional semivariogram, except that the absolute difference is used rather than the squared difference:

$$\gamma_M(h) = \frac{1}{2N} \sum_{i=1}^N |f_{1i} - f_{2i}|$$

The semirodogram and the semimadogram are particularly effective for establishing range and anisotropy. They should not be used for modeling the nugget of semivariograms (Deutsch & Journel, 1992).

Viewing the Experimental Variograms

After setting up the lag interval and choosing a variogram type, the **OK** button is selected in the *Experimental Variogram* dialog. At this point, the experimental variogram is computed. For large scatter point sets, this may take a significant amount of time.

Once the experimental variogram is computed, it is added to the list of experimental variograms in the upper right corner of the *Variogram Editor* and it is displayed in the variogram plotting window. One of the variograms in the list is always highlighted. The name, color, and symbols (used to plot the variogram) of the highlighted variogram can be edited. In addition, the display of each variogram can be turned on and off so any combination of experimental variograms can be plotted. Selecting the **Delete** button deletes the highlighted variogram. Selecting the **Edit** button causes the *Experimental Variogram* dialog to come up initialized with the values used in the computation of the highlighted variogram. When the **OK** button is selected, the values of the variogram are recomputed.

Creating Model Variograms

Once a set of experimental variograms are computed, one is chosen and a model variogram is constructed to fit the experimental variogram. The model variogram is constructed using the items in the lower half of the Variogram Editor.

Model Functions

Four types of model functions are supported for building model variograms. Each of the functions are characterized by a nugget, contribution, and range.

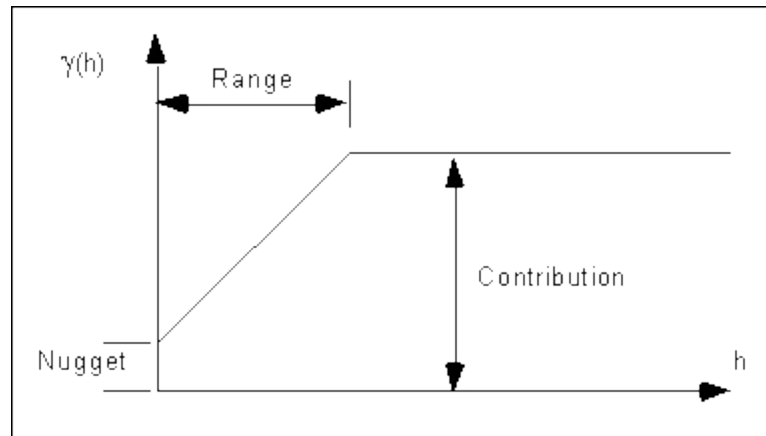

The parameters used to define a model variogram

The nugget represents a minimum variance. The contribution is sometimes called the "sill" and represents the average variance of points at such a distance away from the point in question that there is no correlation between the points. The range represents the distance at which there is no longer a correlation between the points.

The four model functions supported are:

Spherical Model

The Spherical Model is defined by a range $-a-$ and a contribution $-c-$ as:

$$\gamma(h) = \begin{cases} c \left[1.5 \frac{h}{a} - 0.5 \left(\frac{h}{a} \right)^3 \right], & \text{if } \frac{h}{a} \leq a \\ c & \text{if } \frac{h}{a} > a \end{cases}$$

Exponential Model

The Exponential Model is defined by a parameter $-a-$ and a contribution $-c-$ as:

$$\gamma(h) = c \left[1 - \exp \left(-\frac{3h}{a} \right) \right]$$

Gaussian Model

The Gaussian Model defined by a parameter $-a-$ and a contribution $-c-$ as:

$$\gamma(h) = c \left[1 - \exp \left(-\frac{3h^2}{a^2} \right) \right]$$

Power Model

The Power Model is defined by a power $0 < a < 2$ and a slope c as:

$$\gamma(h) = ch^a$$

Nested Structures

A model variogram is constructed using a combination of one or more model functions. Each instance of a model function is called a "nested structure". A nested structure is created by selecting the **New** button in the *Nested Structure* section of the dialog. A new structure is created and added to the list of nested structures. The model variogram plotted in the variogram plot window represents the combination of all of the nested structures in the list. One of the nested structures in the list is highlighted at all times. The selected structure can be deleted by selecting the **Delete** button under the list. The name, model function type, contribution, and range of the selected structure can be edited (the nugget is the same for all nested structures, i.e., only the contribution and range of each structure are summed). As the parameters defining the structure are altered, the plot of the model variogram is updated dynamically in the variogram plot window. This type of instantaneous feedback provides a powerful tool for "sculpting" a model variogram in an intuitive manner until it fits the selected experimental variogram.

In most cases, a single nested structure is adequate. For cases with complex experimental variograms, using multiple nested structures to define the model variogram can prove useful.

Modeling Anisotropy

Some datasets exhibit anisotropy, i.e., the correlation between scatter points changes with direction. For example, due to the depositional history of an alluvial soil deposit, parameters such as porosity and hydraulic conductivity may be most strongly correlated in one direction. This means the differences in the data values change relatively little in one direction compared to how much they change with distance in the orthogonal direction. The direction corresponding to the highest correlation (smallest change) is called the major principal direction and the orthogonal direction is the minor principal direction.

One of the more powerful features of the kriging method is that anisotropy can be detected by generating experimental variograms in orthogonal directions and looking for differences. When anisotropy exists, the model variogram can be constructed to match the anisotropy and ensure that the differences in the continuity of the data each of the orthogonal directions is accurately modeled in the interpolated dataset.

Detecting Anisotropy

Anisotropy can be detected by generating a focused experimental variogram in each orthogonal direction and observing whether or not there are significant differences in the resulting variograms. When constructing an experimental variogram with the *Experimental Variogram* dialog, directional data corresponding to an axis of anisotropy can be entered. The meaning of the directional data is illustrated in the following figure:

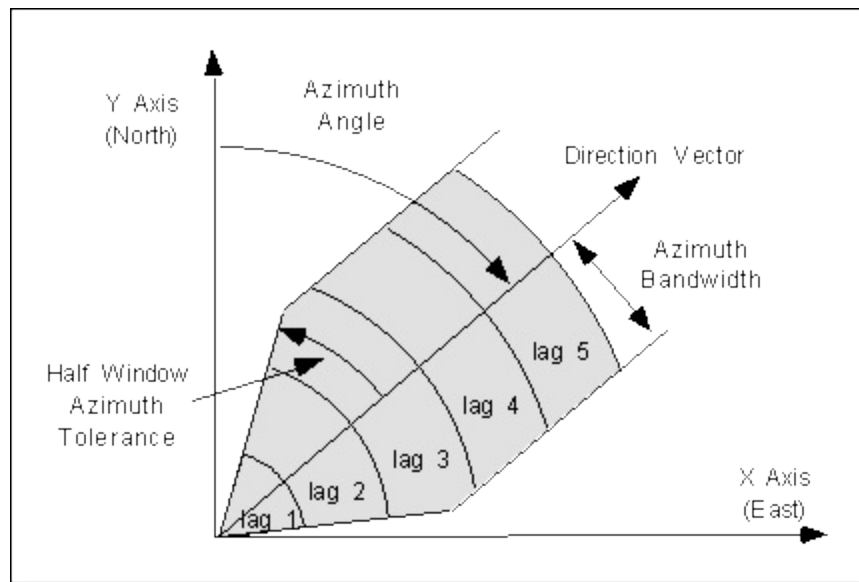

The directional data used to detect anisotropy

When a scatter point is compared with each of the other scatter points to compute the experimental variogram, only those points falling within the shaded area shown in the figure above are considered. The shaded area is defined by the azimuth angle, the azimuth bandwidth, the half window azimuth tolerance, and the lag intervals. For isotropic conditions, the half window azimuth tolerance should be set to 90° (the default value). This forces all points to be included in the calculation of the experimental variogram.

Anisotropy is typically detected using a trial and error process. Pairs of experimental variograms are generated, the pairs being offset from each other by an azimuth angle of 90° . If anisotropy exists, the ranges of the two variograms will differ as shown below. If the data are isotropic, the azimuth angle will have little effect on the resulting experimental variograms. The angles which produce the pair of experimental variograms with the largest difference in ranges represent the principal axes of anisotropy. The variogram with the larger range represents the major principal axis and the variogram with the shorter range represents the minor principal axis.

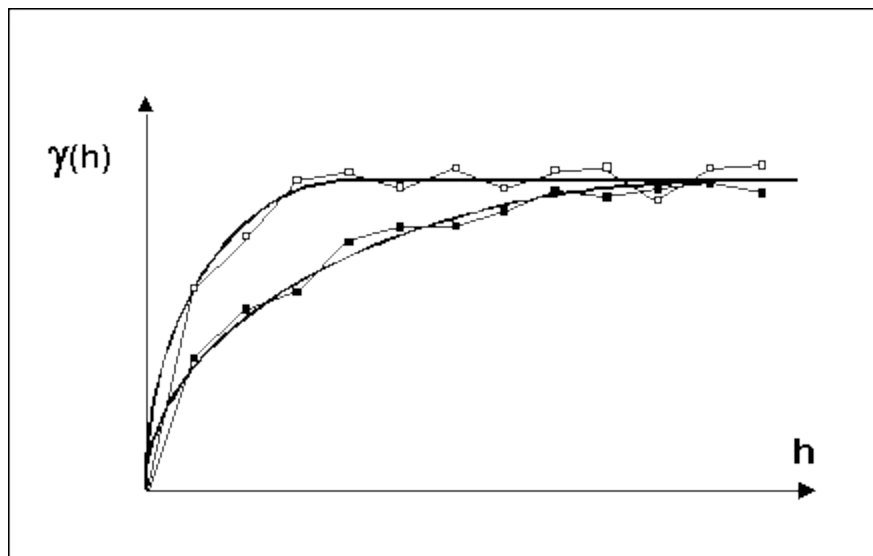

Experimental and model variograms for anisotropic conditions

Anisotropy Method

Once anisotropy has been detected, the next step is to model the anisotropy using the model variogram.

The azimuth angle corresponding to that major principal axis (the one with the longer range) should be entered in the azimuth angle field in the lower left corner of the *Variogram Editor* (the dip and plunge fields are for 3D kriging and are dimmed for 2D interpolation). A model variogram should then be constructed which fits the experimental variogram corresponding to the major principal direction. The anis1 parameter in the *Variogram Editor* should then be changed to a value other than unity (the default value). Changing the anis1 parameter to a value less than unity causes two curves to be drawn for the model variogram as shown in the above figure. The second curve corresponds to the original curve with the range parameter multiplied by the anis1 value. In other words, the anis1 parameter represents the range in the minor direction divided by the range in the major direction. The anis1 parameter should be altered until the second curve fits the experimental variogram corresponding to the minor principal axis of anisotropy. Each of the nested structures has an anis1 parameter that can be edited. Once again, as the anis1 parameter is altered, the variogram plot is updated dynamically, allowing a fit to be made in a simple intuitive fashion. Once the correct anis1 factor is found, the *Variogram Editor* should be exited and the azimuth and anis1 factors should be entered in the [Search Ellipsoid](#) dialog to define a search ellipse that

matches the variogram anisotropy.

Saving Variograms

Once a variogram or set of variograms is defined, the variograms are saved with the dataset files when the project is saved to disk. Thus, when the project is read back in to GMS, the variograms are ready to be used for interpolation and do not need to be redefined.

See also

- [Kriging](#)

4.7. Jackknifing

Jackknifing

Jackknifing is a special type of interpolation which can be useful in analyzing a scatter point set or an interpolation scheme. When the **Jackknifing** command is selected, the active scatter point set is interpolated to itself using the currently selected interpolation scheme. This process can take several minutes. Each point in the set is processed one at a time. The point is temporarily removed and the selected interpolation scheme is used to interpolate to the location of the missing point using the remaining points. Ideally, the interpolated value should correspond closely to the original measured value at the point. By interpolating to each point, a new dataset is generated for the scatter point set.

This new dataset can be compared with the original dataset using the **Summary** command in the *Interpolation* menu. The command brings up the *Jackknifing Summary* dialog.

Jackknifing Summary Dialog

Select an original dataset. under *Base dataset*, then select the dataset created from jackknifing, under *Jackknifed datasets*. The *Mean error*, *Mean absolute error*, and the *Root mean squared error* are automatically calculated.

For transient datasets, the *Base time step* can be selected. For a transient jackknifed dataset, a list of available time steps will be display. Each available time step can be selected to view the summary data for that time step.

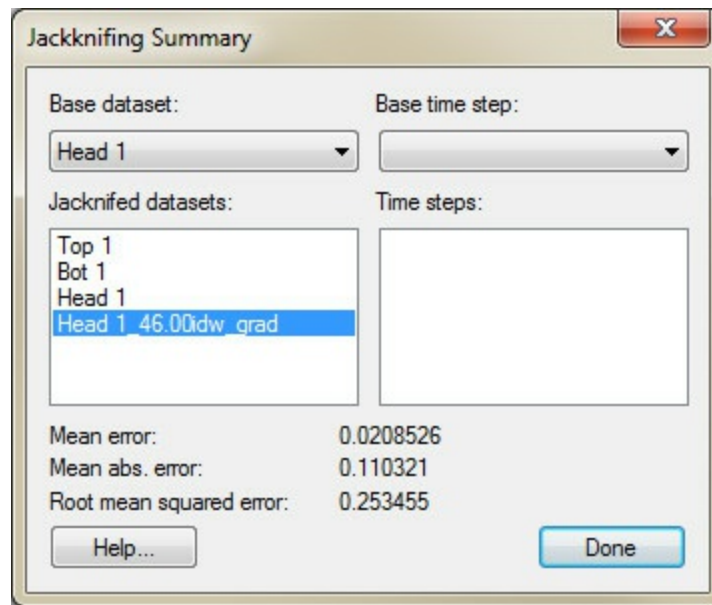

Example of the Jackknifing Summary dialog.

See also

- [Interpolation](#)
- [2D Scatter Point Commands](#)

5. Modules

5.1. TIN Module

TIN Module

TIN stands for Triangulated Irregular Network. TINs are used for surface modeling. TINs are formed by connecting a set of XYZ points with edges to form a network of triangles. TINs can be used to represent the surface of a geologic unit or the surface defined by a mathematical function.

TINs in GMS can be [created](#) manually, imported, or created from other data objects. By default, GMS uses the Delaunay criterion to [triangulate](#) TINs.

GMS provides a variety of [tools](#) and [commands](#) for [manipulating](#) TINs. TINs can be contoured, displayed in oblique view with mapped images and hidden surfaces removed, and have several other [display options](#) that can be set to visualize and understand the terrain surface better. GMS also contains custom [settings](#) for using TINs and allows TINs to be [converted](#) into other types of data, including [solid models](#) and [3D meshes](#). Through GMS it is possible to both import and export [TIN files](#).

Several TINs can be modeled at once in GMS. One of the TINs is designated as the "active" TIN. The selection and [editing tools](#) apply to the active TIN only.

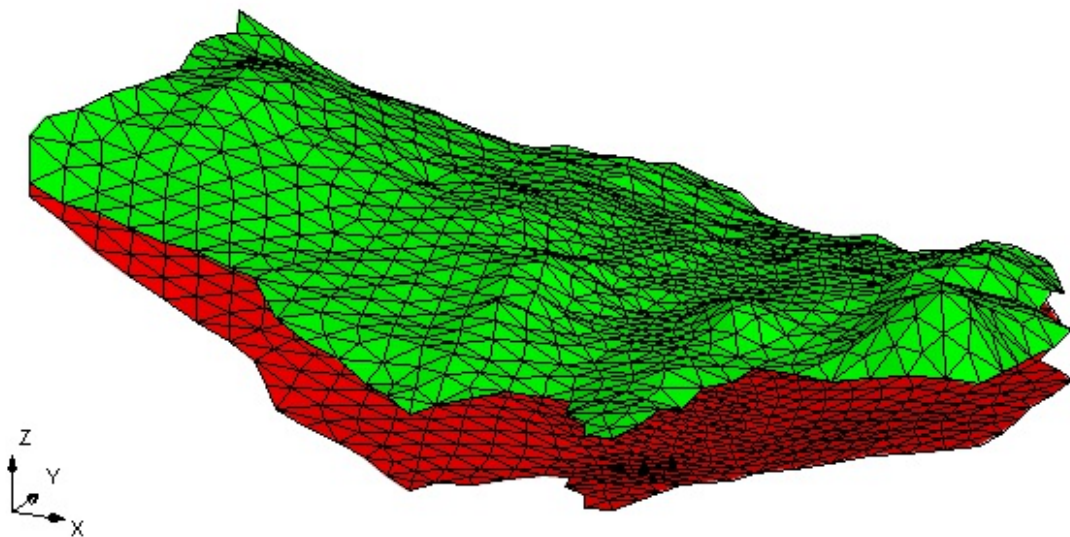

Example of a TIN in GMS

The TIN module can be added to a [paid edition](#) of GMS by purchasing the Subsurface

Characterization Tools.

Creating a TIN

In order to create a TIN in GMS, there must be a set of TIN vertices. Then the TIN is created by triangulating the vertices (connecting the vertices with lines to form triangles). The [triangulation](#) algorithm assumes that each of the vertices being triangulated is unique in the xy plane, i.e., no two points have the same xy location. Duplicate points can be removed by selecting **Find Duplicates** from the *TINs* menu.

TINs can be created 3 different ways in GMS: manually entering the vertex locations and triangulating, converting a different GMS data type to a TIN, and copying a currently existing TIN.

Manually Creating a TIN

A TIN can be created manually from the following steps:

1. Right-click in the empty space of the [Project Explorer](#) and select the **New** → **TIN** command.
2. Select the **Create Vertices** tool from the [TIN Tool Palette](#).
3. Create the vertices by clicking inside the Graphics Window at the xy coordinates where the vertex is to be located. (To change the vertex location see: [Editing a TIN](#))
4. Select the [Triangulate](#) command from the *TINs* menu.

Creating a TIN from GMS Data

[2D meshes](#), [2D grids](#), and [2D scatter points](#) can all be converted to a TIN. This is accomplished by using the following commands:

[Mesh to TIN](#)

A triangle is created from each triangular element in the mesh.

[Grid to TIN](#)

Creates a new TIN from the selected 2D grid.

[Scatter Points to TIN](#)

Creates a set of TIN vertices.

Contacts to TIN

Creates a TIN surface from a set of selected contacts.

Watertable to TIN

Uses water table coordinates from a set of boreholes to converted to TIN.

Add Contacts to TIN

This command is used to enter a point from a contact into the active TIN . The contact(s) are first selected and the command is then chosen from the *Borehole* menu. Typically all contacts which should be part of a TIN are selected before generating the TIN, but sometimes one is inadvertently left out, or more boreholes are added later.

Copying a Current TIN

To make a copy of a TIN that currently exists in GMS follow these steps:

1. Select the TIN to be copied using the **Select TINs** tool.
2. Select the **Duplicate TIN** command from the right-click menu. A dialog appears prompting for the Z-offset of the new TIN. The Z offset is used to displace the TIN above or below the TIN being duplicated.

Editing a TIN

TINs can be edited several ways. The selection and editing tools apply only to the active TIN. If going to edit vertices, the user must first turn off the *TINs* | **Lock All Vertices** menu command.

Editing TIN Vertices

Creating New TIN Vertices

New vertices can be created using the **Create Vertices** tool from the [TIN tool palette](#). Clicking in the Graphics Window creates a new vertex at the point clicked (vertices can only be created when in **Plan View**). The default z value and other parameters governing the creation of new vertices can be set by selecting the **TIN Settings** command from the *TINs* menu.

Deleting TIN Vertices

Selected TIN vertices can be deleted by hitting the *Delete* key or by selecting the **Delete** command from the *Edit* menu. If the **Confirm Deletions** option in the [Preferences](#) dialog is on, the user is prompted to confirm each deletion.

Editing TIN Vertex Coordinates

Two methods of editing TIN vertex coordinates are available. To manipulate vertex coordinates, the **Select Vertex** tool must be selected from the [TIN Tool Palette](#).

- A vertex can be moved to a new position by clicking on the vertex and holding down the mouse button while dragging the vertex to the desired position. If the current view is plan view, dragging the vertex causes it to move in the xy plane. GMS does not allow the vertex to be dragged to a position where one of the surrounding triangles becomes inverted. If the current view is not the plan view, the vertex moves along the z-axis.
- The vertex position and z value can also be manipulated by selecting the vertex and

changing the XYZ values that will appear in the x, y, and z edit boxes in the [Edit Window](#).

Snap Vertices to TIN

It is sometimes useful to snap the vertices of one TIN to another TIN. This is useful when modeling pinch out zones and truncations. The TIN containing the vertices to be moved should be the active TIN, since vertex selection can only be done for the active TIN. After the desired vertices have been selected, the ***Snap Vertices to TIN*** command of the *TINs* menu should be selected. GMS then prompts the user to select the TIN to which the vertices are snapped. The selected vertices' z coordinate values are then modified such that they lie on the selected TIN.

Editing Triangles of a TIN

Create Triangles

The ***Create Triangles*** tool is used to manually create new triangles. Triangles are normally created by triangulating a set of points automatically. However, this tool is useful for manually editing and refining a TIN. To use the Create Triangles tool:

- Select the three vertices of the triangle. The vertices can be selected in either clockwise or counter-clockwise order.
- Drag a box around three vertices of the triangle.

Deleting Triangles

- Using the **Select Triangles** tool, the triangles may be selected and deleted.
- *Boundary Triangles* – The perimeter of the TIN resulting from the triangulation process corresponds to or approximates the convex hull of the TIN vertices. This may result in some long thin triangles or "slivers" on the perimeter of the triangulated region. There are several ways to deal with the long thin triangles. Thin triangles can be selected and deleted using the normal selection procedures. There is also an option for selecting thin triangles when the [Select Triangles](#) tool is selected. If the *Control* key is held down, it

is possible to drag a line with the mouse. All triangles intersecting the line are selected. Long thin triangles on the perimeter of the TIN can also be selected by selecting the **Select Boundary Triangles** command from the *TINs* menu. The **Select Boundary Triangles** command checks triangles on the outer boundary first. If the length ratio of the triangle is less than the critical length ratio, the triangle is selected and the triangles adjacent to the triangle are then checked. The process continues inward until none of the adjacent triangles violate the minimum length ratio. The critical length ratio for selecting thin triangles can be set by selecting the *TINs* | **TIN Settings** menu command. The length ratio is defined as the longest side of the triangle divided by the sum of the two shorter sides.

Changing Triangle Density

The density of a TIN can be quickly increased using the **Uniformly Subdivide TIN** command in the *TINs* menu. A dialog will ask for a subdivision factor and the factor is used to uniformly subdivide the TIN into sub-triangles as shown below:

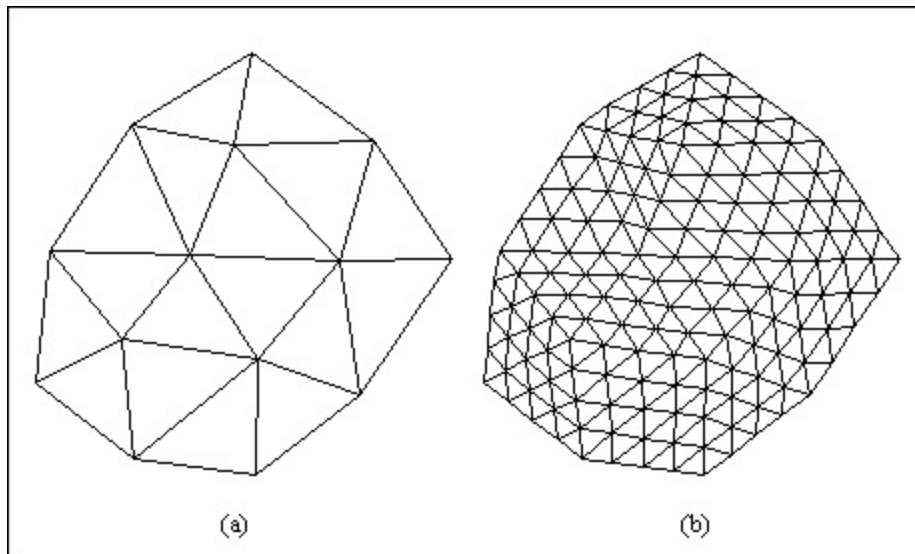

TIN (a) before and (b) after uniform subdivision.

Subdivide TIN

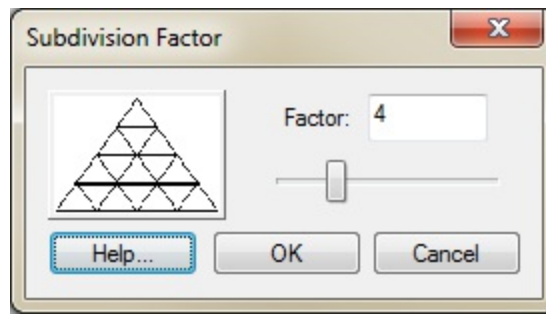

The Subdivision Factor dialog

This command can be used to "smooth" a TIN. When using a TIN for contouring, the contours are computed using a linear interpolation of the triangles. If the vertices are sparse, the contours may not appear to be smooth. The contours can be smoothed by copying the vertices to a scatter point set, subdividing the TIN into sub-triangles, and interpolating the z values (or other datasets) from the scatter point set to the new vertices defining the sub-triangles.

Subdivision and smoothing can be accomplished using the following steps:

- If multiple TINs exist, make sure the TIN is the active TIN.
- Convert the TIN to a scatter point set using the **TIN** → **Scatter Points** command in the *TINs* menu.
- Subdivide the TIN by selecting the **Subdivide TIN** command from the *TINs* menu and use the *Subdivision Factor* dialog.
- Switch to the [2D Scatter Point module](#) and select an interpolation method using the **Interp. Options** command in the *Interpolation* menu.
- Select the to **Active TIN** command from the *Interpolation* menu. This creates a new dataset for the selected TIN.

Adding Breaklines

A breakline is a feature line or polyline representing a ridge or some other feature to preserve in a mesh made up of triangular elements. In other words, a breakline is a series of edges to which the triangles should conform to, i.e., not intersect.

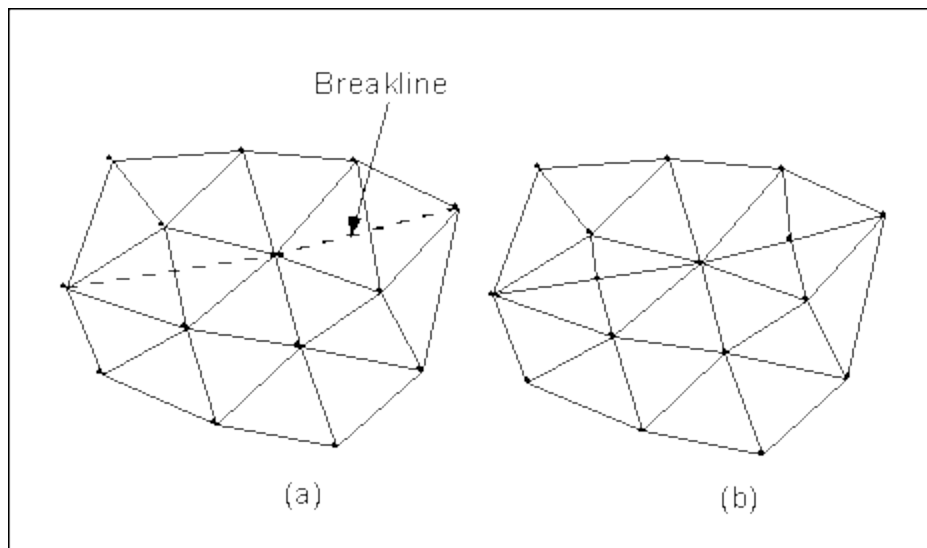

Breaklines (a) triangulated mesh and breakline. (b) triangulated mesh after the breakline has been processed.

Breaklines can be processed using the **Add Breaklines** command from the *Mesh* menu. Before selecting the command, one or more sequences of nodes defining the breakline(s) should be selected using the **Select Node Strings** tool in the [2D Mesh Tool Palette](#).

As each breakline is processed, the triangles intersected by the breakline are modified by adding new nodes at necessary locations to ensure that the edges of the triangles will conform to the breakline. The elevations of the new nodes are based on a linear interpolation of the breakline segments. The locations of the new nodes are determined in such a way that the [Delaunay criterion](#) is satisfied.

TIN Settings

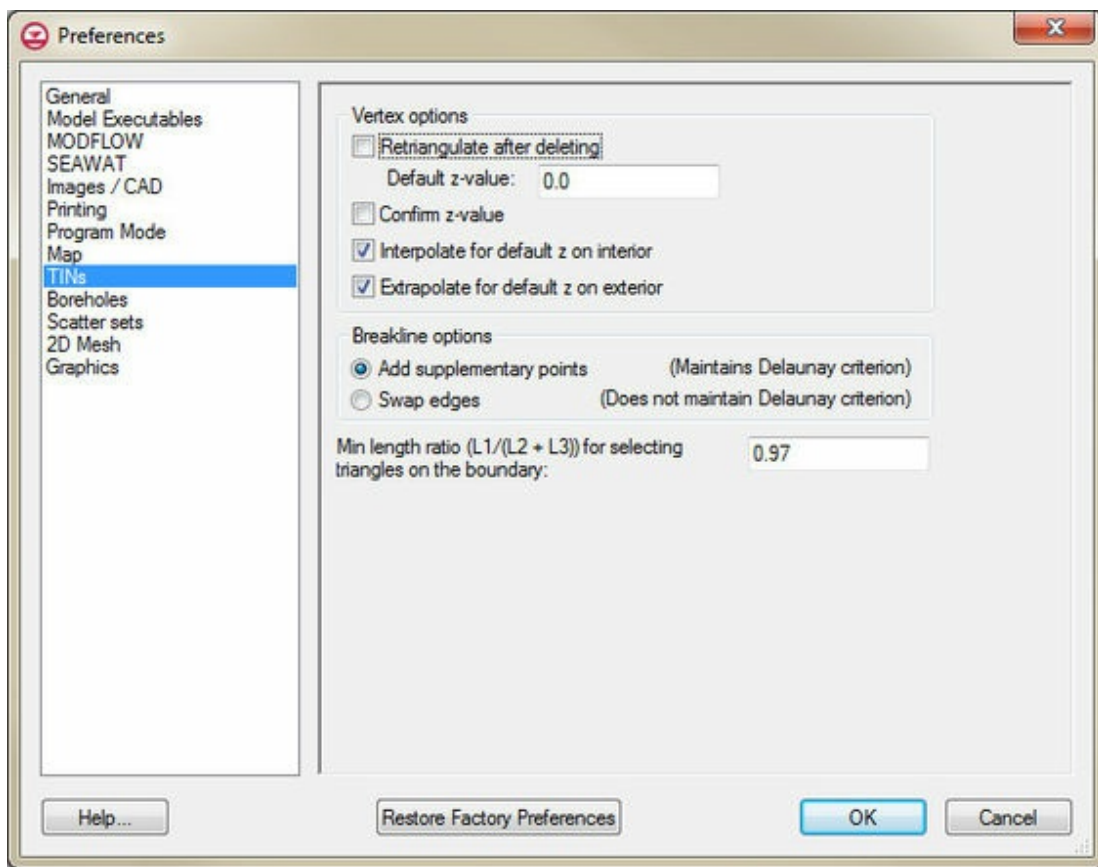

The settings for the TIN module can be found in the *Preferences* dialog under the *TINs* item. The *Preferences* menu can be reached by using the **Preferences...** command in the *Edit* menu and then selecting the *TINs* item; or it can be reached by using the **TIN Settings...** command in the *TINs* menu. The following settings are available:

- *Retriangulate After Deleting* – If this option is on, the region surrounding the vertex is retriangulated as each vertex is deleted. Otherwise, the triangles adjacent to the vertex are simply deleted.
- *Adjust Boundary to Include Exterior Vertices* – If this option is on, the boundary of the TIN is changed so that the new vertex becomes part of the TIN if a new point is added outside the active TIN. If the new vertex is in the interior of the active TIN, the vertex is automatically incorporated into the TIN.
- *Default Z-Value* – The default z value is assigned to all new vertices created with the **Create Vertex** tool.
- *Confirm Z-Values* – If this option is on, GMS prompts for a z value each time a new vertex is created.
- *Interpolate For Default Z On Interior* – If this option is on and a new vertex is created in the interior of a TIN, a default z-value is linearly interpolated from the plane equation defined by the triangle containing the point.
- *Extrapolate For Default Z On Exterior* – If this option is on and a new vertex is entered outside the TIN boundary, a default z-value is extrapolated from the TIN to the new vertex.



The Preference dialog showing the TINs tab

TIN Display Options

The properties of all TIN data that GMS displays on the screen can be controlled through the *TIN* tab of the *Display Options* dialog. This dialog is opened by right-clicking on the  TIN Data entry in the [Project Explorer](#) and selecting the **Display Options** command. It can also be accessed from the *Display* menu or the **Display Options**  macro. The following table describes the display options available for the TIN module.

Display Option	Description
Vertices	If the <i>Vertices</i> item in the <i>TIN Display Options</i> dialog is set, the TIN vertices are displayed each time the Graphics Window is refreshed. Since it is possible to accidentally drag points, vertices can be "locked" to prevent them from being dragged or edited by selecting the Lock ALL Vertices command from the <i>TINs</i> menu. Vertices can be unlocked by unchecking the Lock ALL Vertices command in the <i>TINs</i> menu. Both a "Locked" and "Unlocked" vertex color may be set so that there is a visible difference when displaying the TIN. (See Editing TINs)
Triangle edges	If this item is on the lines that make up each triangle are displayed. The color of the triangle edges can be adjusted according to the following options: <ol style="list-style-type: none">1. Auto – Draws the material color if faces are not displayed. Uses black or white if the faces are displayed.2. Specified – Used the color specified next to the triangle edges3. Material – Displays the material color of the triangle
Triangle faces	The <i>Triangle faces</i> item causes the faces of the triangles to be drawn as filled polygons.
Texture map image to active TIN	The <i>Texture map image</i> item is used to "drape" an image over the surface of the TIN.
TIN boundary	The <i>TIN boundary</i> feature is often used in conjunction with contours in order to display the contours without cluttering the screen by displaying each triangle.

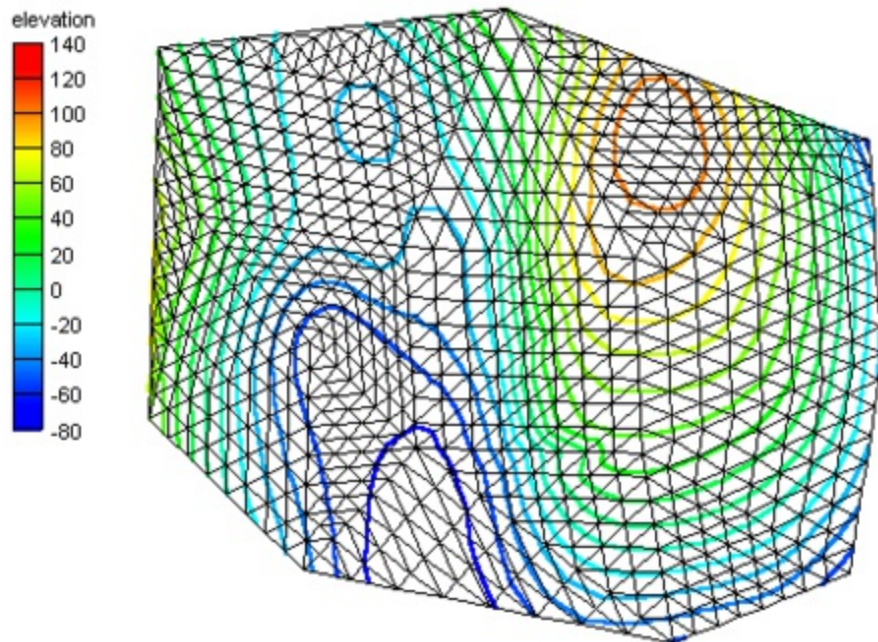

Contours displayed together with the TIN triangles

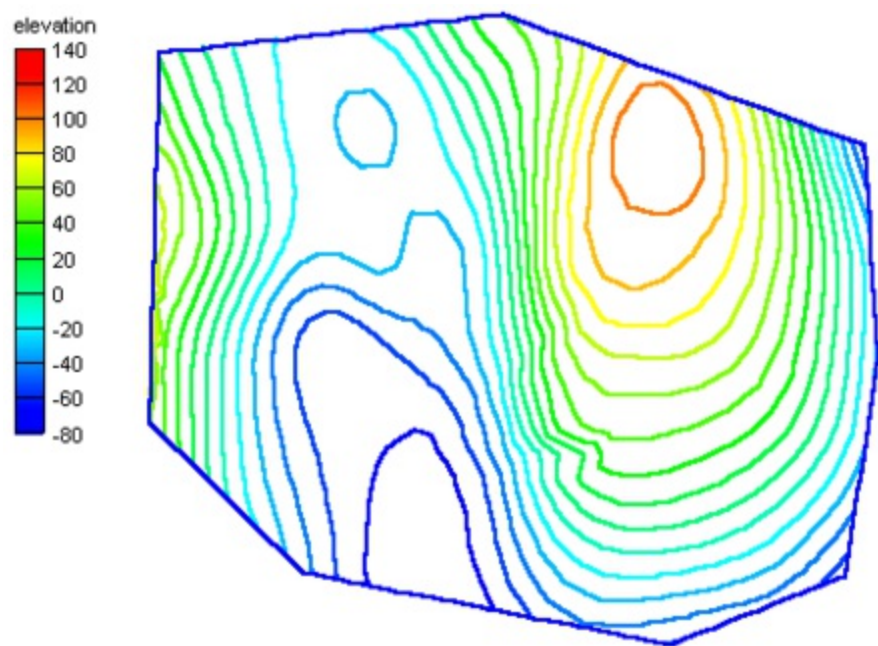

Contours displayed with the TIN boundary

Thiessen polygons

If the *Thiessen polygons* item is set, a Thiessen polygon for each TIN vertex is displayed each time the display is refreshed. The edges of the Thiessen polygons are formed by the perpendicular bisectors of the edges of the triangles in the TIN. The vertices of these polygons correspond to the centers of the circumcircles of the [Delaunay triangulation](#). Any location inside a Thiessen polygon is closer to the TIN vertex contained in that polygon than to any other TIN vertex.

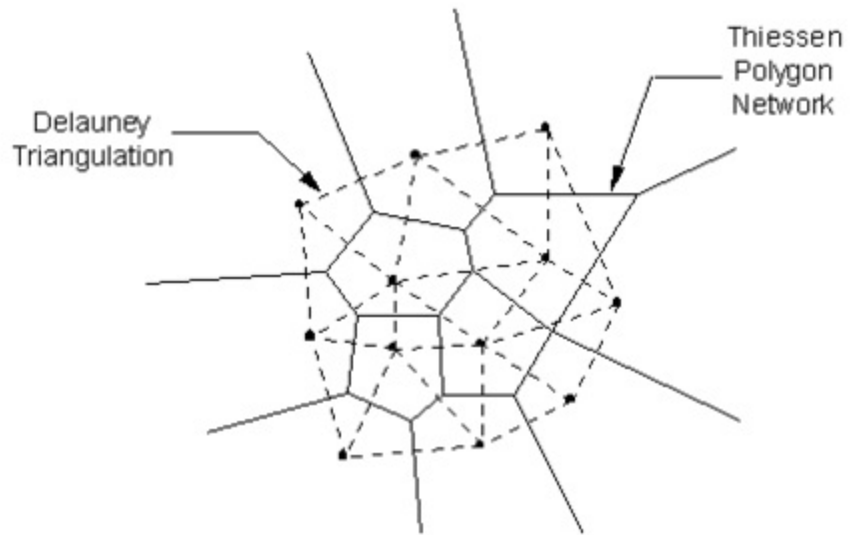

Thiessen polygons for this TIN

Circumcircles If the *Circumcircles* item is set, the circumcircle enclosing the three vertices for each triangle are drawn when the display is refreshed. Circumcircles provide the basis of a [Delaunay triangulation](#) since the Delaunay criterion is satisfied by ensuring that no circumcircle encloses a vertex. Displaying circumcircles can aid in the understanding of the triangulation process.

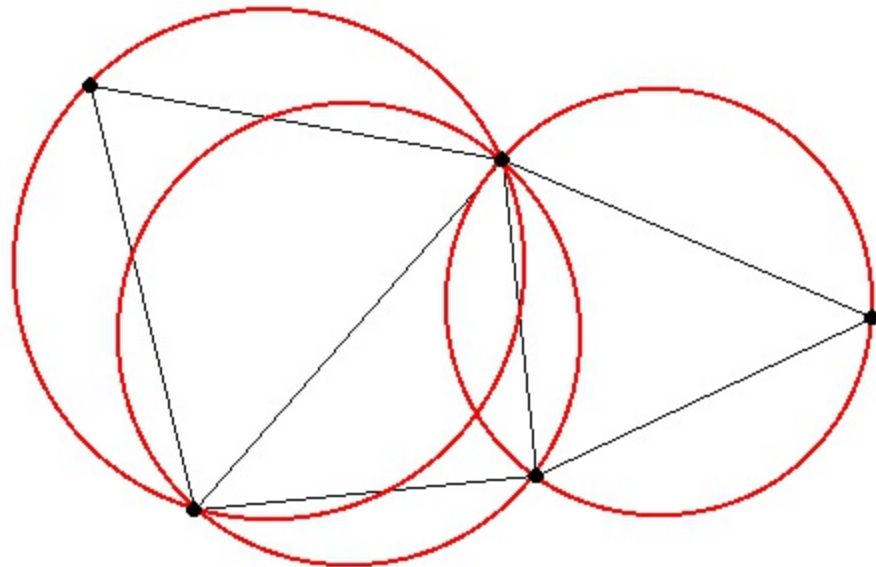

The red circles are the circumcircles for the TIN

Vertex numbers If the *Vertex numbers* item is set, the number of each vertex is displayed adjacent to the vertex.

Scalar values If the *Scalar values* item is set, the active dataset value of each vertex is displayed adjacent to the vertex.

Contours Most of the objects supported by GMS can be contoured by turning on the [Contour Options](#) in the *Display Options* dialog. When an object is contoured, the values associated with the active dataset for the object are used to generate the contours.



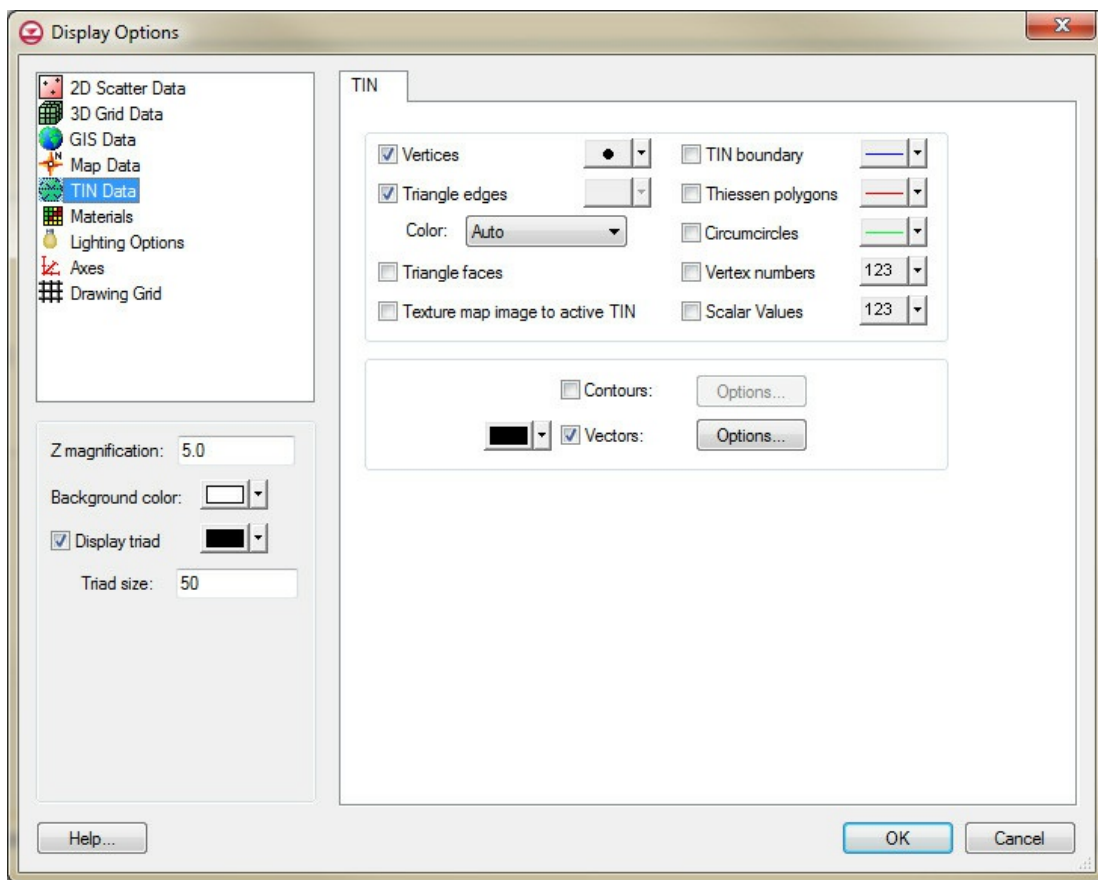





Vectors If the [Vectors](#) item in the *Display Options* dialog is selected for an object (TIN, Grid, or Mesh), vector plots can be generated using the active vector dataset for the object. One vector is placed at each node, cell, or vertex.



The Display Options dialog showing the TIN tab.

TIN Tool Palette

The following tools appear in the dynamic portion of the tool palette when the TIN module is active. Only one tool is active at any given time. The action that takes place when the user clicks in the [Graphics Window](#) with the cursor depends on the current tool. The tools are for selection and interactive editing of TINs. The table below describes the tools in the TIN tool palette.

Tool	Tool Name	Description
	Select Vertices	The Select Vertices tool is used to select vertices for operations such as deletion, or to drag a vertex to a new location. The coordinates of selected vertices can also be edited using the <i>Edit Window</i> .
	Select Triangles	The Select Triangles tool is used to select triangles for operations such as deletion.
	Select TINs	<p>The Select TINs tool is used to select TINs for operations such as deletion. When this tool is active, a TIN icon appears at the centroid of each TIN. A small letter "A" appears in the icon of the active TIN. A TIN is selected by selecting the icon. A TIN can be designated as the active TIN by double-clicking on the TIN icon. When a different tool is selected, the icons disappear.</p> <p>In some cases, several TINs occupy approximately the same location and the icons for the TINs overlap. In such cases, it may be difficult to select the desired TIN. An alternate way to select TINs is to use the Select From List command in the <i>Edit</i> menu. This brings up a list of the currently available TINs and a TIN is selected by highlighting the name of the desired TIN and selecting the OK button.</p>
	Select Vertex Strings	<p>The Select Vertex Strings tool is used to select one or more strings of vertices. Vertex strings are used for operations such as adding breaklines to the TIN. The procedure for selecting vertex strings is somewhat different than the normal selection procedure. Strings are selected as follows:</p> <ul style="list-style-type: none"> • Click on the starting vertex for the string. The vertex selected will be highlighted in red. • Click on any subsequent vertices to be part of the string (vertices do not have to be next to each other) and double-click on the final vertex. The selected vertices are now connected by a solid red line. <p>To remove the last vertex from a string, press the <i>Backspace</i> key. To abort entering a vertex string, press the <i>ESC</i> key. To end a vertex string, press <i>Return</i> or double-click on the last vertex in the string. Another vertex string can then be selected.</p>
	Create Vertices	The Create Vertices tool is used to manually add vertices to a TIN. It can only be used in plan view. When this tool is selected, clicking on a point within the Graphics Window will place a vertex at that point. What happens to the vertex after it is added (whether and how it is triangulated into the TIN) depends on the settings in the <i>Vertex Options</i> dialog under the <i>Modify TINs</i> menu.
	Create Triangles	<p>The Create Triangles tool is used to manually create new triangles. Triangles are normally created by triangulating a set of points automatically. However, this tool is useful for manually editing and refining a TIN. To use the Create Triangles tool:</p> <ul style="list-style-type: none"> • Select the three vertices of the triangle. The vertices can be selected in either clockwise or counter-clockwise order. • Drag a box around three vertices of the triangle.
	Swap Edges	The Swap Edges tool swaps the common edge of two adjacent triangles. To use the tool, simply click on any edge in the TIN.
	Contour Labels	The Contour Label tool manually places numerical contour elevation labels at points clicked on with the mouse. These labels remain on the screen until the contouring options are changed, until they are deleted using the <i>Contour Label Options</i> dialog, or until the Graphics Window is refreshed. Contour labels can be deleted with this tool by holding down the <i>Shift</i> key while clicking on the labels. This tool can only be used when the TIN is in plan view.

Converting TINs to Other Data Types

TINs may be converted to other types of data used in GMS, such as a 2D mesh or 2D scatter points. TINs can be converted by right-clicking on the TIN in the [Project Explorer](#), Right-clicking on the TIN in the graphics window, or using the following commands in the TIN menu:

TIN → 2D Scatter Points

The **TIN → 2D Scatter Points** command creates a 2D scatter point set from the active TIN . One scatter point is created for each vertex in the TIN. A copy is made of each of the datasets associated with the TIN and the duplicate datasets are stored with the new scatter point set.

TIN → 2D Mesh

The **TIN → 2D Mesh** command creates a 2D finite element mesh from the active TIN . One triangular element is created for each triangle in the TIN. Any datasets associated with the TIN are copied to the new mesh.

Fill Between TINs → 3D Mesh

See [Creating a 3D Mesh](#).

TIN Boundary → Polygons

This command creates one or more polygons in the active coverage in the [Map module](#) corresponding to the outer boundary of the active TIN.

TIN Thiessen → Polygons

This command calculates the Thiessen polygons from the TIN and converts them to feature polygons.

TIN → UGrid

Converts the TIN to a 2D [UGrid](#).

Vertex Strings → Arcs

The **Vertex Strings → Arcs** command creates an arc in the active coverage of the [Map module](#) for each of the selected [vertex strings](#).

Horizons → Solids

See [Horizons → Solids](#).

Horizons → 3D Mesh

See [Horizons → 3D Mesh](#).

Building Solids and 3D Meshes with TINs

TINs can be used to build 3D solid models as well as 3D meshes. This can be done by selecting the following commands in the **TINs** menu:

Horizons → Solids

Horizons → 3D Mesh

Fill Between TINs → 3D Mesh

See [Creating a 3D Mesh](#)

TINs can be used to build three-dimensional solid models of the soil layers. The transformation from TINs to solids is accomplished using a TIN extrusion and [set operation](#) procedure illustrated in two dimensions in the following figure. A two-dimensional cross section of three TINs, labeled p, q, and r, is shown in part (a).

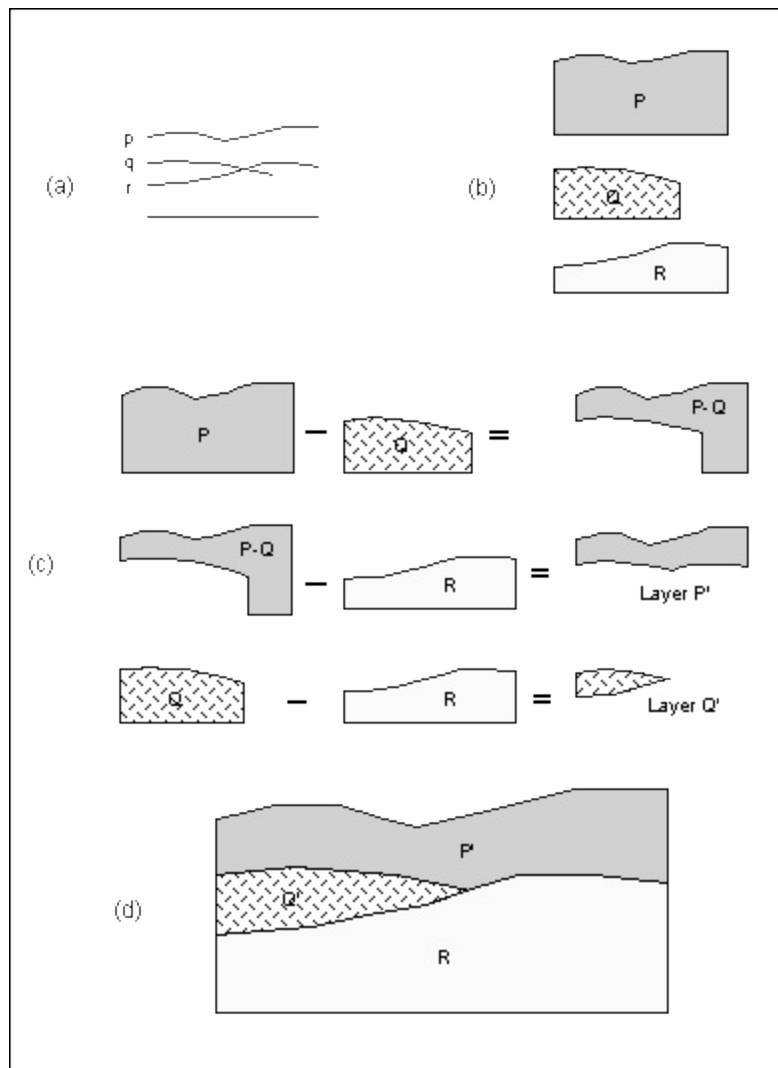

The TIN extrusion and set operation process. (a) Sample TINs. (b) Extrusion of surfaces into solids. (c) Creation of layers through set operations. (d) Completed solid model of soil stratigraphy.

The TINs are converted into temporary solid primitives that represent approximations of the soil layers. The conversion is accomplished by projecting the outer boundary (perimeter) of each TIN down to a horizontal plane. This can be thought of as an extrusion process where a two-dimensional surface is extruded into a three-dimensional solid. A three-dimensional illustration of this process is shown in the figure below.

Boundaries are created around the perimeter of the solid and one large boundary is created at the base of the solid. The elevation of the horizontal plane is chosen so that the resulting solid is below the lowest point of interest. A series of two-dimensional cross sections of the primitive solids P, Q, and R formed by extruding the TINs in part (a) of the figure above is shown in part (b).

The final step of the modeling process consists of combining the primitive solids to form solid models of the soil layers. This is accomplished using set operations. Portions of the solids that overlap other solids are "trimmed" away and adjacent solids are forced to match precisely at the boundaries. This step of the modeling process is illustrated in part c. Primitive Q is subtracted from primitive P to produce the temporary solid P-Q. Primitive R is then subtracted from P-Q to produce the solid P'. The solid Q' is formed by subtracting primitive R from primitive Q. The primitive R does not intersect other solids and needs no trimming. Cross sections of the completed solid models of the soil layers are shown in part (d).

The combination extrusion/set operation process can be simplified in some cases. For example, within GMS it is possible to create solid P' directly by "filling" between TIN p and the two TINs q and r. GMS accomplishes this by combining the process described above for creating solid P' into a single operation. The user simply selects TINs p, q, and r and performs the **Fill Between TINs** → **Solid** command in the Build *TINs* menu of the **TIN** module.

The combination of **TIN editing**, TIN extrusion, and **set operations** represents a powerful and flexible tool that makes it possible to model complex stratigraphic relationships such as truncations, faults, embedded seams, and pinchout zones. Once the models are constructed, the volumes of the solids can be viewed using the Get Info command in the File menu. In addition, the models can be further modified using set operations to simulate complex excavations. Cross sections and fence diagrams can be constructed from the solid models at any location and at any orientation.

Additional Commands

The preferred method for creating solids is the Horizons method mentioned above. The following commands are legacy operations that are less robust and not supported.

TINs → **Extruded Solid**

Creates a new solid from each of the selected TINs by extruding each of the TINs up or down to an elevation specified by the user. Extruded TINs are useful in the construction of solid models of soil stratigraphy.

Fill Between TINs → Solid

Provides a quick way to create a solid bounded above and below by two or more selected TINs. The TIN defining the top of the boundary of the solid should be selected first. The remaining TIN(s) are then selected. All selected TINs are extruded down to an arbitrary elevation below that of all the selected TINs. GMS then performs a difference set operation.

See also

- [Solid Module](#)
- [3D mesh generation](#)

Triangulation

A TIN is constructed by triangulating a set of vertices. The vertices are connected with a series of edges to form a network of triangles. The resulting triangulation satisfies the Delaunay criterion. As the triangulation process proceeds, adjacent triangles are compared to see if they satisfy the Delaunay criterion. If necessary, the adjacent edge of the two triangles is swapped (the diagonal of the quadrilateral defined by the two triangles is changed to the other two vertices) in order to satisfy the Delaunay criterion. This edge swapping process forms the basis of the triangulation algorithm.

When a new point is inserted into a TIN, the point is incorporated into the TIN and the edges of the triangles adjacent to the new point are swapped as necessary in order to satisfy the Delaunay criterion.

If the Delaunay criterion is satisfied everywhere on the TIN, the minimum interior angle of all of the triangles is maximized. The result is that long thin triangles are avoided as much as possible. The Delaunay criterion ensures that no vertex lies within the interior of any of the circumcircles of the triangles in the network as shown below:

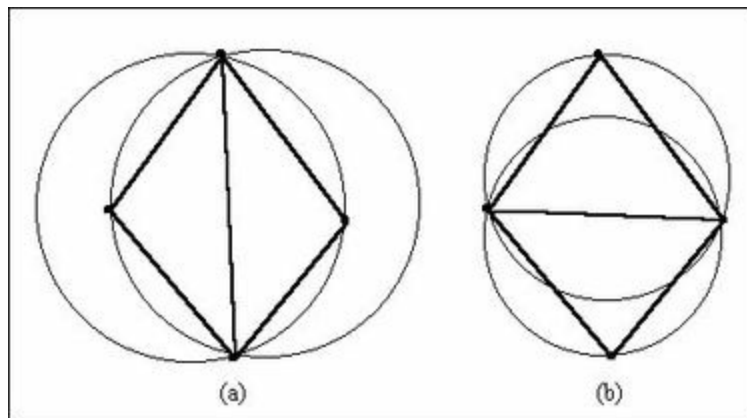

Two Adjacent Triangles Which (a) Violate and (b) Honor the Delaunay Criterion

The vertices associated with the active TIN can be triangulated using the **Triangulate** command from the *TIN* menu, or by right-clicking on the TIN in the [Project Explorer](#) and

selecting the **Triangulate** command. The same **Triangulate** commands exist for 2D mesh in the *Mesh* menu or by right-clicking on the mesh.

GMS also contains [settings](#) for triangulation in the *Preferences* dialog for both TINs and meshes.

See also

- [2D Mesh Module](#)
- [3D Mesh Module](#)
- [TIN Module](#)
- [Natural Neighbor](#)

TIN Files

TIN files are used for storing Triangulated Irregular Networks. The TIN file format is shown below and a sample file is shown after. The TIN file format can be used to import a simple set of XYZ coordinates since the triangle information (beginning with the TRI card) does not need to be present. If there is a file of XYZ coordinates, only add the TIN, BEGT, and VERT nv cards to the top of the file and the ENDT card at the end.

```
TIN                /* File type identifier */
BEGT               /* Beginning of TIN group */
TNAM name          /* Name of TIN */
TCOL id            /* TIN material id */
VERT nv           /* Beg. of vertices */
x1 y1 z1 lf1      /* Vertex coords. */
x2 y2 z2 lf2
.
.
.
xnv ynv znv lfnv
TRI nt             /* Beg. of triangles */
v11 v12 v13       /* Triangle vertices */
v21 v22 v23
.
.
.
vnt1 vnt2 vnt3
ENDT              /* End of TIN group */
```

Sample TIN File:

```
TIN
BEGT
```

TNAM Aspen

TCOL 255 255 255

VERT 408

0.0 3.1 7.8 0

5.3 8.7 4.0 1

.

.

2.4 4.4 9.0 1

TRI 408

5 1 4

4 1 2

.

.

4 2 3

ENDT

Cards used in the TIN file

Card Type	TIN
Card ID	3000
Description	File type identifier. Must be on first line of file. No fields.
Required	YES

Card Type	BEGT
Card ID	3000
Description	Marks the beginning of a group of cards describing a TIN. There should be a corresponding ENDT card at a latter point in the file. No fields.
Required	YES

Card Type	TNAM		
Description	Provides a name to be associated with the TIN.		
Required	NO		
Format	TNAM name		
Sample	TNAM aspen		
Field	Variable	Value	Description
1	name	str	The name of the TIN.

Card Type	TCOL		
Description	Defines a default color for the triangles of the TIN		
Required	NO		
Format	TCOL color_red color_green color_blue		
Sample	TCOL 255 255 255		
Field	Variable	Value	Description
1	color_red	0–255	The red color component of TIN triangles.
2	color_green	0–255	The green color component of TIN triangles.
3	color_blue	0–255	The blue color component of TIN triangles.

Card Type	MAT		
Description	Associates a material id with the TIN. This is typically the id of the material which is below the TIN.		
Required	NO		
Format	MAT id		
Sample	MAT 3		
Field	Variable	Value	Description
1	id	+	The material ID.

Card Type	VERT		
Description	Lists the vertices in the TIN		
Required	YES		
Format	VERT nv x ₁ y ₁ z ₁ lf ₁ x ₂ y ₂ z ₂ lf ₂ . . x _{nv} y _{nv} z _{nv} lf _{nv}		
Sample	VERT 4 0.0 3.1 7.8 0 5.3 8.7 4.0 1 2.4 4.4 9.0 1 3.9 1.2 3.6 0		
Field	Variable	Value	Description
1	nv	+	The number of vertices in the TIN
2–4	x,y,z	±	Coords. of vertex
5	lf	0,1	Locked / unlocked flag for vertex (optional). 0=unlocked, 1=locked. Repeat fields 2-5 nv times.

Card Type	TRI		
Description	Lists the triangles in the TIN		
Required	NO (a set of triangles can be generated from the vertices)		
Format	TRI nt V ₁₁ V ₁₂ V ₁₃ V ₂₁ V ₂₃ V ₂₃ . . V _{nt1} V _{nt2} V _{nt3}		
Sample	TRI 4 5 1 4 4 1 2 4 2 3 5 4 3		
Field	Variable	Value	Description
1	nt	+	The number of triangles in the TIN.
2–4	v1,v2,v3	+	Vertices of triangle listed in a counter-clockwise order. Repeat nt times.

Card Type	ENDT
Card ID	3000
Description	Marks the end of a group of cards describing a TIN. There should be a corresponding BEGT card at a previous point in the file. No fields.
Required	YES

TIN Commands

When the TIN module is active, the following commands can be found in the *TIN* menu:

New TIN...

Creates a new TIN and opens the *TIN Properties* dialog.

Lock All Vertices

Since it is possible to accidentally drag points, vertices can be "locked" to prevent them from being dragged or edited by toggling on this command.

TIN Settings...

Opens the *Preferences* dialog to the settings affecting TINs.

Triangulate

Creates triangles from existing vertices on the active TIN using the *Delauney* criteria. If triangles already exist, they will be deleted.

Subdivide TIN...

Opens the *Subdivision Factor* dialog that allows entering a factor by which existing triangles will be split into smaller triangles.

TIN → 2D Scatter Points

Creates a new *2D Scatter Point set* from the vertices of the active TIN. The scatter points could then be used for interpolation.

TIN → 2D Mesh

Creates a new *2D mesh* from the active TIN, preserving the triangles.

Fill Between TINs → 3D Mesh

Creates a *3D mesh*, or adds onto an existing 3D mesh, by filling in the space between two TINs. A 2D mesh must exist and is used as a projection mesh for the 3D elements. Two TINs must be selected.

Horizons → Solids...

Opens the Horizons to Solids wizard which can be used to create *solids* from a combination of boreholes, TINs and conceptual models.

Horizons → 3D Mesh...

Opens the *Horizons to Mesh* wizard which can be used to create a *3D mesh* from a

combination of boreholes, TINs and conceptual models.

Horizons → UGrid...

Opens the *Horizons to UGrid* wizard, which can be used to create a [UGrid](#) from a combination of boreholes, TINs, and conceptual models.

TIN Boundary → Polygons

Creates a new coverage containing a polygon derived from the outer boundary of the TIN.

TIN Thiessen → Polygons

Creates a new coverage containing polygons derived from the [thiessen polygons](#) of the TIN.

TIN Contours → Arcs

Creates a new coverage containing feature arcs derived from the linear contours displayed on the TIN.

Vertex Strings → Arcs

Creates a new coverage containing a feature arc derived from the vertex string on the TIN (if one exists).

TIN → Extruded Solid

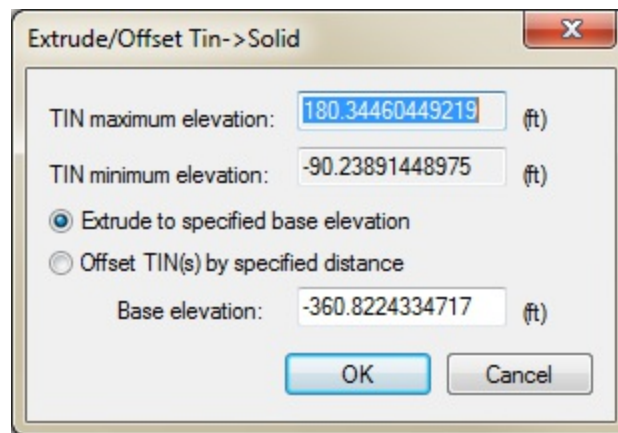

The Extrude/Offset Tin → Solid dialog

Opens the *Extrude/Offset Tin → Solid* dialog which is used to extrude the TIN vertically up or down to form a solid.

Fill Between TINs → Solid

Creates a [solid](#) by extruding one or more TINs to a base elevation and then performing a [set operation](#) to remove the solid portions outside the TINs.

Add Breakline(s)

Inserts edges into the TIN from a defined breakline, splitting or swapping triangles as necessary.

Select Boundary Triangles

Selects triangles on the outer boundary which meet the "long and thin" criteria specified in [TIN settings](#).

Snap Vertices to TIN

Given some selected vertices, moves them so that they are on the surface of a TIN selected from a dialog.

Intersect TINs

Displays the intersection line between two selected TIN surfaces (if they intersect).

Horizons → HUF

Opens the *Horizons → HUF* wizard to create [MODFLOW HUF](#) data from TINs and boreholes. TINs or boreholes with horizon data defined are required, along with a MODFLOW simulation which uses the HUF package.

Z Values → Dataset

Creates a dataset from the Z locations of the vertices.

Map to Z Values

Moves the Z locations of the vertices to the values in the dataset.

Zoom To Extents

Frames the Graphics Window around the selected objects.

Related Topics

- [TIN Module](#)

5.2. Boreholes Module

Boreholes

The Borehole module of GMS can be used to visualize boreholes created from drilling logs or synthetic boreholes created manually and to construct three-dimensional [cross sections](#) between boreholes. These cross sections show the soil stratigraphy between two boreholes.

Borehole data can be [imported or created](#) in GMS. The borehole module contains its own set of [tools](#) and [commands](#) for manipulating borehole data as well as its own display options. Borehole data can be [converted](#) to other types of objects such as 2D scatter points, TINs, 3D meshes.

The module also allows using [hydrogeologic units \(HGUs\)](#) to be defined on boreholes.

The Borehole module can be added to a [paid edition](#) of GMS.

Types of Borehole Data

A borehole can contain either stratigraphy data or sample data or both.

Stratigraphy

Stratigraphy data are used to represent soil layers that are encountered in a soil boring. The soil layers are represented using contacts and segments as shown below. A segment represents a soil layer and a contact is the interface between two segments. GMS assumes no-flow bedrock below the bottom of each borehole when generating the stratigraphy.

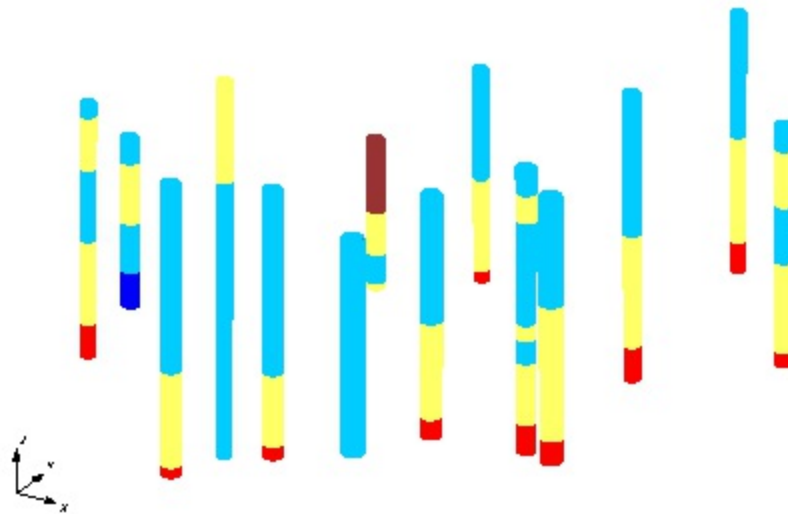

Boreholes representing soil stratigraphy with contacts and segments

Sample Data

Sample data represent data obtained by continuous sampling along the length of the hole. Cone penetrometer data or down-hole geophysical data like permeability are examples of sample data. The figure below shows an example of sample data being displayed. Sample data are stored in datasets which can be displayed and manipulated in a similar fashion as other datasets in GMS. To display the sample data the display options for the borehole data can be modified such that the *Sample data* points and data plots are checked as visible while the borehole edges are hidden in the *Display Options* dialog.

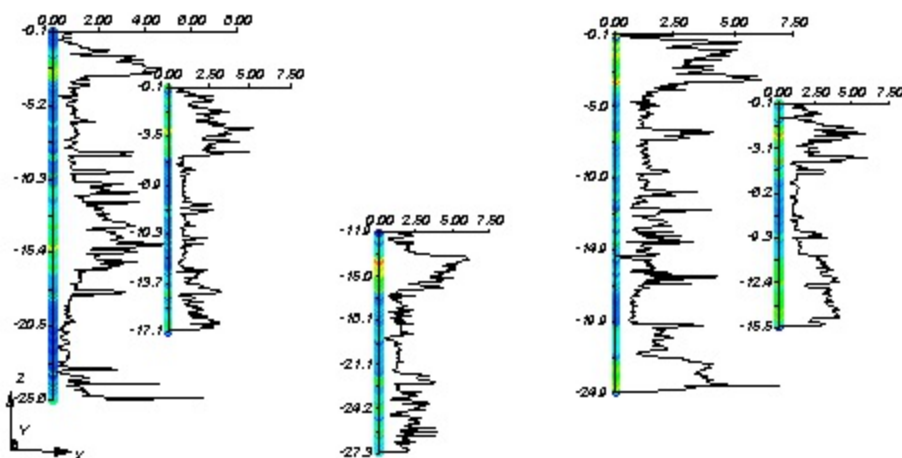

Boreholes with sample data

Creating and Editing Boreholes

Boreholes can be created by importing borehole data, importing sample data, or using the [borehole tools](#) to manually enter the boreholes.

To create a borehole data file, make a file with the borehole name, x, y, z, locations and a material ID. The z location will be the top of the soil layer. Once a borehole has been created and imported, it can be edited in the *Borehole Editor* or by using the borehole tools.

When right-clicking on a borehole in the [Project Explorer](#), copy the borehole by selecting the **Duplicate** command in the pop up menu. This will create a new borehole offset in x and y by 10% of the extents of the current data in GMS. This command is useful when there is a large gap between boreholes. A new borehole with similar stratigraphy to neighboring boreholes can be placed in the gap and the contacts can be positioned as desired. Adding an artificial borehole or a "pseudo-borehole" in the gap gives more control over the shape of the [TINs](#) and solids created from the boreholes.

Boreholes can be locked to prevent them from being edited. When the boreholes are locked, all graphical editing is disabled and a check appears on the menu. This prevents the boreholes, the borehole contacts, and the borehole segments from being inadvertently dragged with the mouse. Also, the [Edit Window](#) becomes disabled. The boreholes can still be edited using the [Borehole Editor](#). The boreholes can be unlocked by selecting the **Lock All Boreholes** command again, and the check in the menu will disappear.

Auto Select

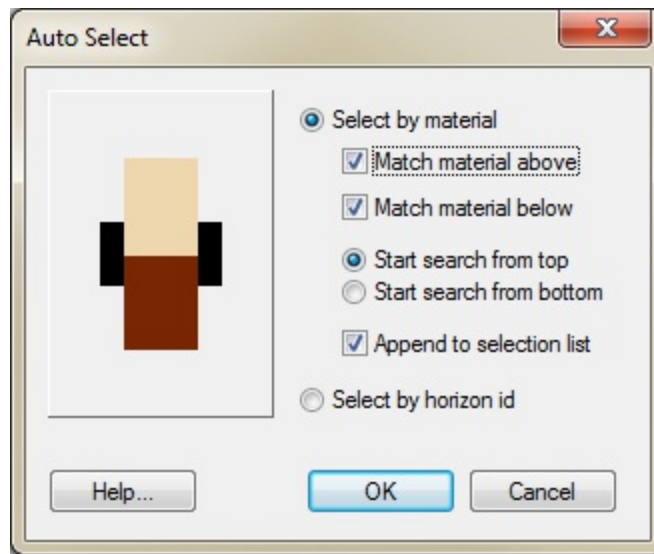

The Auto Select dialog in the Boreholes module

With a large number of boreholes, it may be tedious to individually select all the borehole contacts necessary for an operation. For this reason, the capability to automatically select multiple contacts is provided with the **Auto Select Contacts/Segments** command. One contact representing a prototype or example is first selected and the **Auto Select Contacts/Segments** command is chosen. The *Auto Select* dialog appears showing a close-up of the selected contact and allows for:

- Matching of the material above, below, or both.
- Starting the search from the top or the bottom of the borehole.

Since only one contact per borehole is selected, the appropriate combination of the above options is important. Each borehole is searched from either the top or bottom of the hole until the first match is made. That contact is then added to the set of selected contacts.

The **Auto Select Contacts/Segments** command can also be used with the **Select Segment** tool in the [Borehole tool palette](#) to quickly select all segments matching a selected borehole segment. In this case, the segments are selected automatically and the *Auto Select* dialog does not appear.

Borehole Editor

The *Borehole Editor* can be used to create new boreholes and edit existing boreholes. The existing boreholes are displayed in a tree window at the top of the dialog, with the currently selected borehole being highlighted. The currently selected borehole is drawn along the right side of the dialog. Both Hydrogeologic Units (HGU) and Soils are shown.

The name of the borehole can be changed by clicking on the borehole name in the text window and typing in a new name.

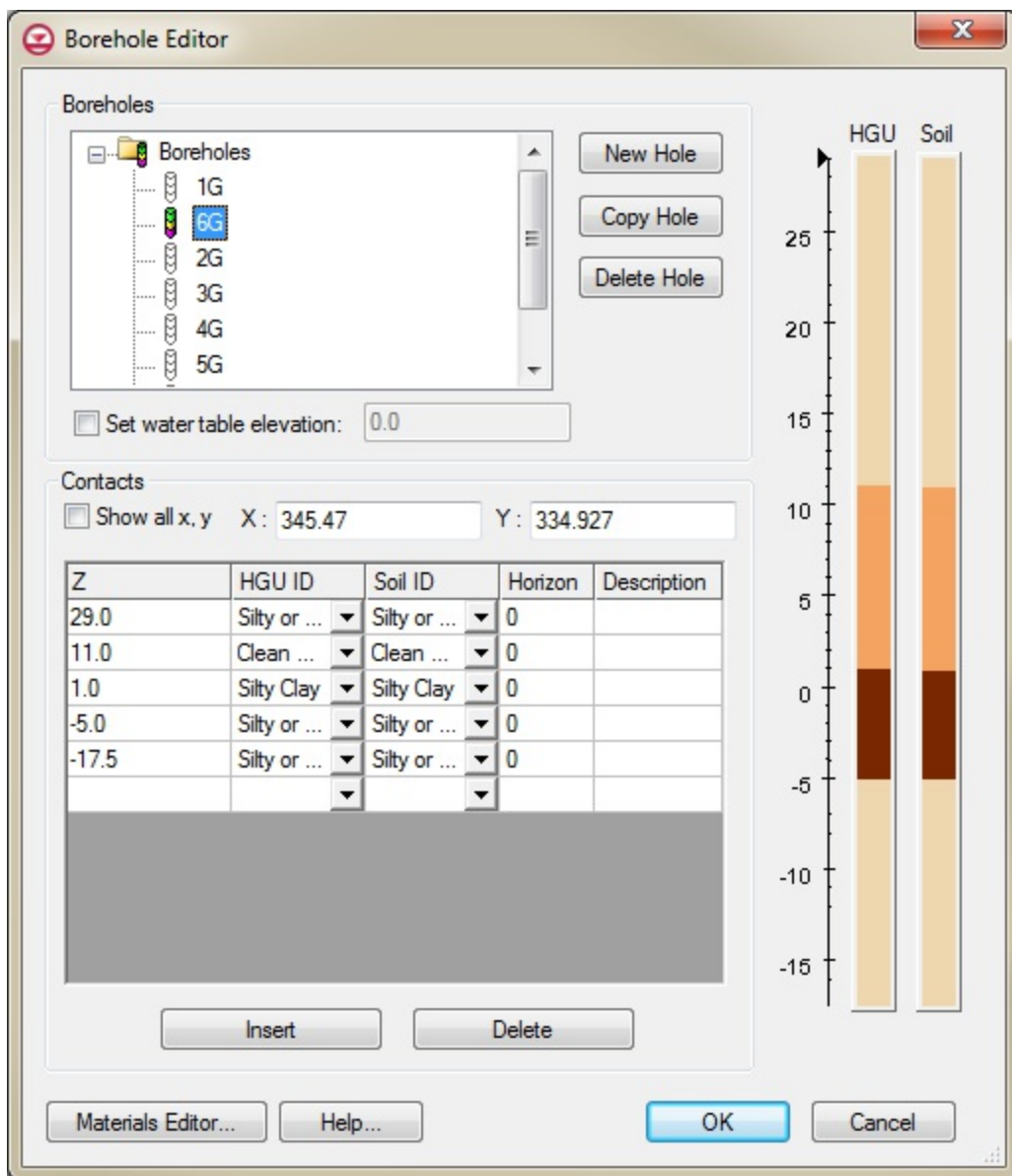

If the **Set water table elevation** toggle is on, a water table elevation can be entered. This can be used to display a water table symbol on each hole.

The borehole's contacts are listed in the spreadsheet in the middle of the dialog. Contacts can be deleted and new contacts can be inserted above the currently selected contact using the buttons just below the spreadsheet. The material below the contact is specified by selecting the material name.



Borehole Editor dialog

Borehole Display Options

The properties of all borehole data that GMS displays on the screen can be controlled through the *Borehole* tab of the *Display Options* dialog. This dialog is opened by right-clicking on the Borehole Data  entry in the *Project Explorer* and selecting the **Display Options** command. It can also be accessed from the *Display* menu or the **Display Options**  macro. The following table describes the display options available for the Borehole module.



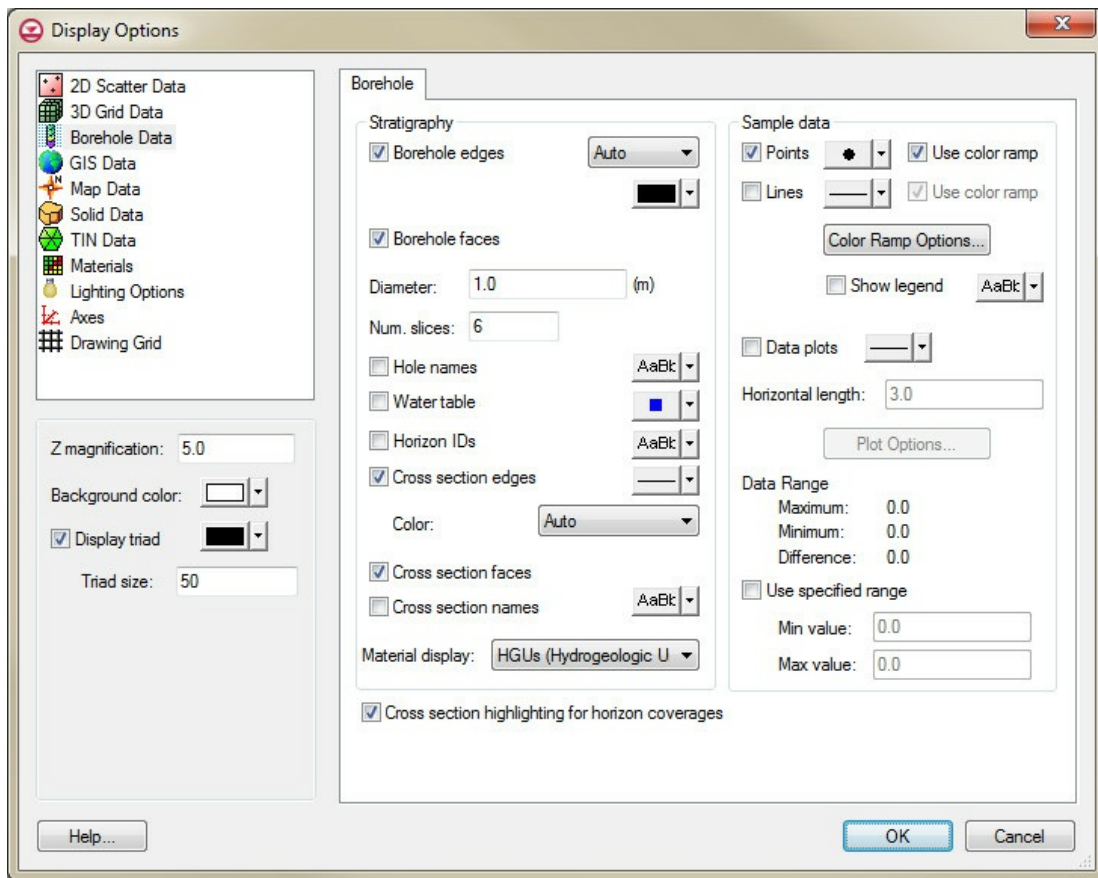



Display Option	Description
Borehole edges	This option controls the display of the lines that show the outline of the boreholes. The color of the borehole edges can be adjusted according to the following options: <ol style="list-style-type: none"> 1. Auto – draws the material color if faces are not displayed. Uses black or white if the faces are displayed 2. Specified – used the color specified next to the borehole edges 3. Material – displays the material color of the borehole segment
Borehole faces	If this option is on then the borehole segments are displayed are filled polygons.
Diameter	This value determines the display size of the boreholes in the graphics window in world length coordinates.
Num. slices	This edit field determines the number of slices to display the borehole. The default is 6 making the boreholes display as hexagons.
Hole names	If the <i>Hole name</i> box is checked, the name of each hole is displayed at the top of the hole.
Water table	If the <i>Water table</i> box is checked, an icon representing the water table is displayed at the water table elevation of each borehole.
Horizon IDs	The <i>Horizon IDs</i> option controls the display of the horizon id next to each borehole contact.
Cross sections edges	The <i>Horizon IDs</i> option controls the display of the horizon id next to each borehole contact. Three options are available for the cross section edges: <ol style="list-style-type: none"> 1. Auto – draws the material color if faces are not displayed. Uses black or white if the faces are displayed 2. Specified – used the color specified next to the cross section edges 3. Material – displays the material color of the stratigraphic unit in the cross section
Cross section faces	If this option is on then the borehole segments are displayed as filled polygons.
Cross section names	If this option is on then the borehole names are displayed above the boreholes.
Material display	This radio group determines the display color of the boreholes. The borehole segments can be colored either by the Soil or HGU assigned.
Cross Section Highlighting for Horizon Coverages	Option displays of the lines showing the part of the cross sections where the material with the horizon ID of the active horizon coverage exists. This highlighting only appears when in plan view and the active coverage is a horizon coverage.
Points	If the <i>Points</i> box is checked, every sample data point is displayed. If the Use color ramp box is checked, the points are colored according to the current dataset and the current color ramp settings.
Lines	If the <i>Lines</i> box is checked, the sample points are connected by a series of line segments. If the Use color ramp box is checked, the line segments are colored according to the current dataset and the current color ramp settings.
Data plots	If the <i>Data plots</i> box is checked, a plot of the current dataset is drawn next to each borehole with sample data. The width (horizontal length) can be adjusted and the options associated with the plot scale, plot axes, etc., can be accessed by selecting the Plot Options button.
Data range	By default, the minimum color on the color ramp is associated with the minimum dataset value and the maximum color is associated with the maximum dataset value. The ramp of colors can be confined to a smaller interval defined by the Maximum and Minimum values. This forces all of the color gradation to be concentrated in a particular range of interest.



The Display Options dialog show the Boreholes tab.

Borehole Tool Palette

The following tools are available in the dynamic portion of the [tool palette](#) whenever the [Borehole Module](#) is activated. Only one tool is active at any given time. The action that takes place when clicking in the [Graphics Window](#) depends on the current tool. The following table describes the tools in the borehole tool palette.

Tool	Tool Name	Description
	Select Borehole	The Select Borehole tool is used to select entire boreholes. Information about the selected borehole can be obtained by using the Get Info command from the <i>File</i> menu. Selected boreholes can be deleted, or dragged with the mouse. In plan view, the borehole can be dragged anywhere in the XY plane. In other views, the borehole can only be dragged up and down along the Z axis unless the <i>Control</i> key is held down, in which case the borehole can be dragged anywhere in the viewing plane. The coordinates of the top of the borehole can be edited in the <i>Edit Window</i> . The name associated with a selected borehole can be edited by double-clicking on the borehole or by selecting the Attributes command from the <i>Edit</i> menu while the borehole is selected.
	Select Segment	The Select Segment tool is used to select the region between two contacts. Information about the selected segment can be obtained by using the Get Info command from the <i>File</i> menu. The selected segment can be deleted unless it is the only segment on the borehole. In plan view, the segment can be dragged anywhere in the XY plane with the mouse. In other views, the selected segment can only be dragged up and down along the Z axis, unless the <i>Control</i> key is held down, in which case the segment can be dragged anywhere in the viewing plane. The coordinates of the top contact on the segment can be edited in the <i>Edit Window</i> . The material associated with the segment can be changed by double-clicking on the segment or by using the Attributes command in the <i>Edit</i> menu. Several segments with the same material type can be selected automatically by using the Auto Select command or they can be selected sequentially while holding down the <i>Shift</i> key.
	Select Contact	The Select Contact tool is used to select the interfaces between soil layers. Selected contacts can be deleted as long as there are at least two contacts remaining on the borehole after deletion. In plan view, the selected contact can be dragged anywhere in the XY plane with the mouse. In other views, the selected contact can only be dragged up and down along the Z axis, unless the <i>Control</i> key is held down, in which case the contact can be dragged anywhere in the viewing plane. The coordinates of the contact can be edited in the <i>Edit Window</i> . Multiple contacts can be selected sequentially by holding down the <i>Shift</i> key, or they can be selected automatically using the Auto Select command. Selected contacts can be used to create TINs. A horizon id can be assigned to a selected contact(s) by selecting the Properties command in the <i>Edit</i> menu.
	Select Cross Section	The Select Cross Section tool selects existing cross sections by clicking on the selection icon in the GMS graphics window when this tool is active. See the figure below.
	Create Borehole	The Create Borehole tool can be used to create a new borehole at the location clicked on by the mouse. First a prompt asks for the missing coordinate (i.e., in plan view, the z coordinate is asked for). Boreholes can not be created in oblique view. The borehole is given a default name of "New Borehole" and three segments which are ten units long by default. A newly created borehole can be edited using the other tools in the Tool Palette or the <i>Borehole Editor</i> .
	Create Contact	The Create Contact tool can be used to create a new contact on an existing borehole by clicking on the borehole at the location where the new contact is to be located. A prompt then asks for the material associated with the contact (the material for the segment below the contact).
	Create Cross Section	The Create Cross Section tool creates user defined cross sections between existing boreholes. To create a single cross-section, click on the first hole and then double-clicks on the second hole. Multiple panels of a cross section can be created at once (i.e., a fence diagram) by single-clicking on sequence of boreholes and double-clicking on the last borehole.

The figure below shows a set of borehole cross sections. The cross section selection icon is the black diamond near the center of each of the cross sections. A cross section can be edited by selecting its corresponding icon and selecting the **Cross Section Editor** command from the *Borehole* menu or by double-clicking on the selection icon.

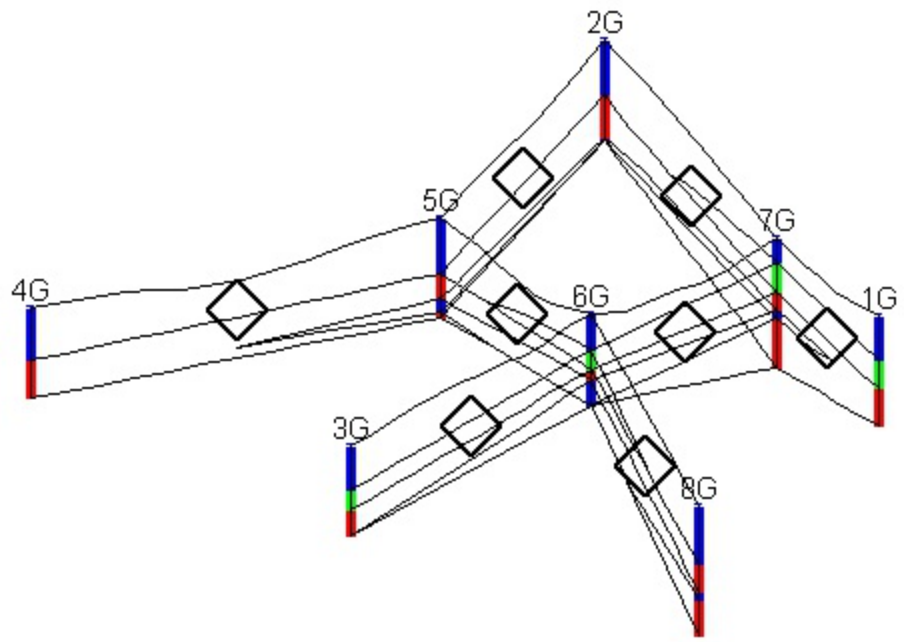

Set of borehole cross sections

Borehole Hydrogeologic Units

Hydrogeologic units (HGUs) can be defined on boreholes. HGUs are typically a simplified representation of the soil layers from the borehole field data. For example, the borehole log may include several types of sand ("brown sand", "gray silty sand", "clean sand"), but for modeling purposes, treat these all as one [material](#), "sand". GMS now shows both the original soils and the simplified HGUs on the boreholes.

Importing Borehole Data

When [importing](#) borehole data, both an HGU and Soil ID column can be [specified](#) in the input. Files containing only a single set of materials can be imported to either field and the other field can be populated using the conversion tools described below.

Creation

The HGU and soil IDs can be edited using the [Borehole Editor](#).

Display

The boreholes can be displayed in the main graphics window using either the HGU IDs or the soil IDs. The ID used for display can be selected in the [Display Options](#) dialog.

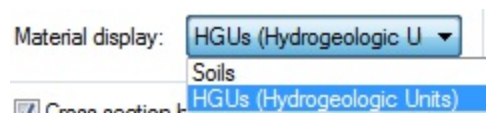

Borehole display options

Soils → HGUs, HGUs → Soils

A set of soil IDs can be converted to a set of HGU IDs using the **Soils→HGUs** command in the *Borehole* menu. Likewise, a set of HGU IDs can be converted to a set of soil IDs using the **HGUs→Soils** command.

Building Cross-Sections, Solids

When building cross-sections or solid models using boreholes, the HGU IDs are used by GMS. The soil IDs are used purely for visualization or for setting up the HGU IDs.

Converting Borehole Data

Borehole data can be converted to other types of objects with in GMS such as 2D Scatter Points, TINs, 3D Meshes. Borehole data is converted by using the following commands in the *Boreholes* menu:

Horizons to Solids

Horizons to HUF

Horizons to 3D Mesh

Contacts to TIN

Used to create a **TIN** surface from a set of selected contacts.

Contacts to 2D Scatter Points

A set of selected contacts can be converted to a 2D scatter point set using the **Contacts** → **2D Scatter Points** command.

Sample Data to 3D Scatter Points

Brings up the *Sample Data* → *Scatter Points* dialog that is used to create a 3D scatter point set from sample data.

Sample Data to Stratigraphy

Opens the *Sample Data* → *Stratigraphy* dialog that allows defining stratigraphy (borehole contacts) based on the sample data.

Watertable to 2D Scatter Points

The water table coordinates for a set of boreholes can be converted to a 2D scatter point set using the **Water Table** → **2D Scatter Points** command. A dialog will appear asking to assign a name to the new scatter set before the conversion is completed.

Add Contacts to TIN

Used to enter a point from a contact into the active TIN. The contact(s) are first selected and the command is then chosen from the *Borehole* menu. Typically all contacts which should be part of a TIN are selected before generating the TIN, but sometimes one is inadvertently left out, or more boreholes are added later.

Borehole Cross Sections

A borehole cross section is a set of polylines and polygons that define the stratigraphy between two boreholes. A borehole cross section can be created manually or automatically.

Creation

Automatic creation

Cross sections can be created automatically using the *Boreholes* | **Auto-Create Blank Cross Sections** menu command. This uses a triangulation process to determine the most likely connections between boreholes. The top and/or bottom arcs of the new cross sections can be warped to match the elevation of [TIN](#) surfaces using the *Snap Cross Sections to TIN* dialog which appears when the *Boreholes* | **Auto-Create Blank Cross Sections** command is executed. Snapping the tops and bottoms of cross sections to TIN surfaces can also be done at any time via the *Boreholes* | *Advanced* | **Snap Cross Sections to TIN** menu command. Keep in mind, however, that warping the top and bottom of a cross section may interfere with the internal polygons that are defined in the cross section, so snapping to a TIN is best done before filling in the cross sections.

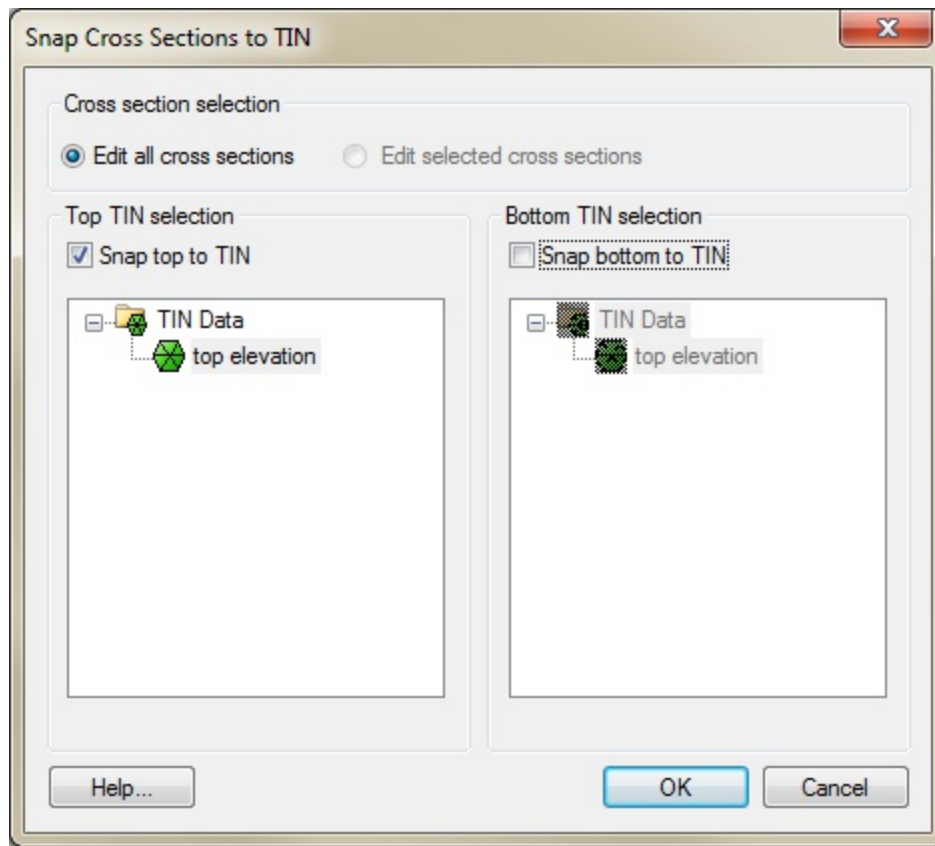

The Snap Cross Sections to TIN dialog

Manual creation

Cross sections can be created manually by using the [Create Cross Section](#) tool and clicking on boreholes.

Editing

When a borehole cross section is first created, it is made up of a set of default lines. The figure below shows a default cross section. Notice that "arcs" (polylines) have been created defining the top and bottom of the cross section and an arc (polyline) has been created for each segment in the boreholes.

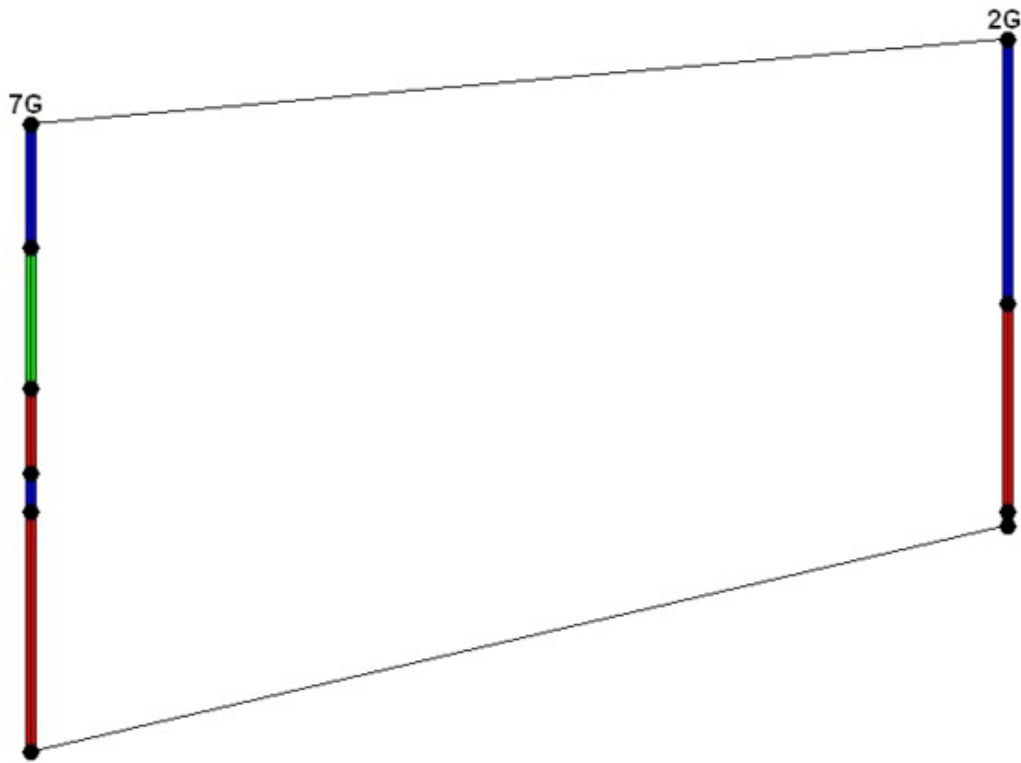

Default cross section

Automatic editing

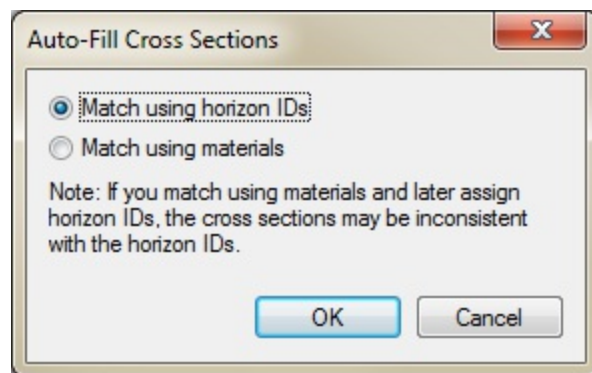

The Auto-Fill Cross Sections dialog

The *Boreholes* | **Auto-Fill Blank Cross Sections** menu command can be used to automatically fill in all existing blank cross sections. The command can use either the [horizon](#) IDs (preferred) or materials information on the boreholes.

Manual editing

To edit a cross section manually, use the **Select Cross Section** tool and select a cross section. The *Cross Section Editor* dialog can be then opened by selecting the **Cross Section Editor** command from the *Borehole* menu while either a single or a series of cross sections selected. It is also possible to launch the *Cross Section Editor* dialog by double-clicking on a single cross section. The next figure shows a finished cross section.

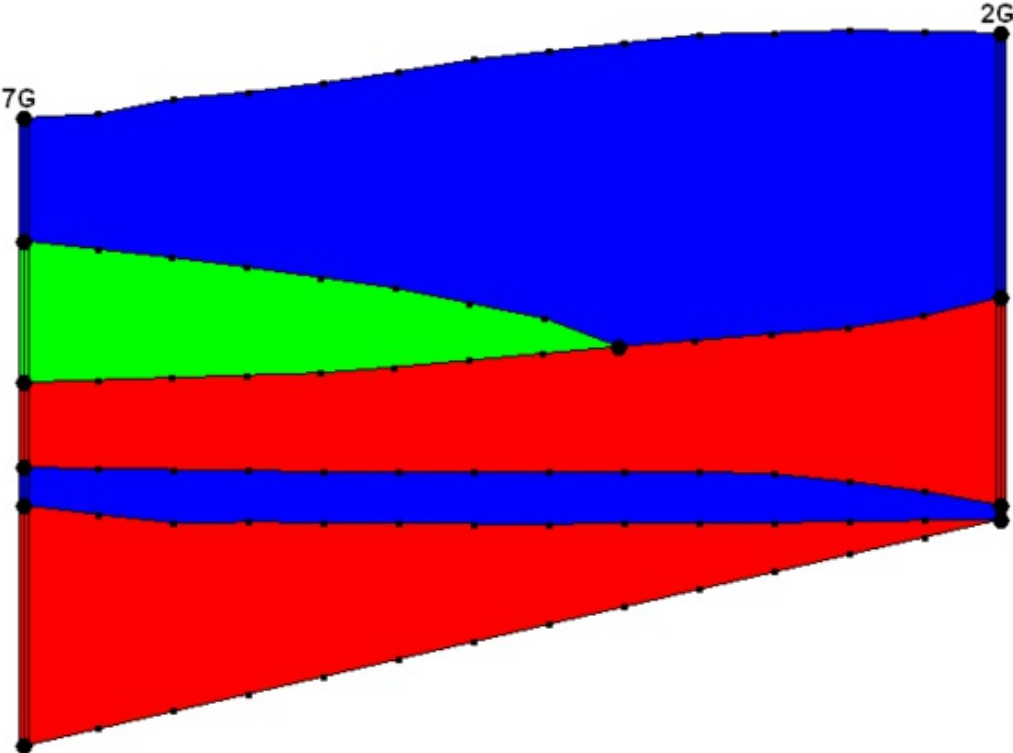

Complete cross section

Restrictions

GMS imposes the following restrictions on cross sections that should be kept in mind when editing:

1. All polygons must be connected to boreholes
2. All arcs must connect to borehole contacts





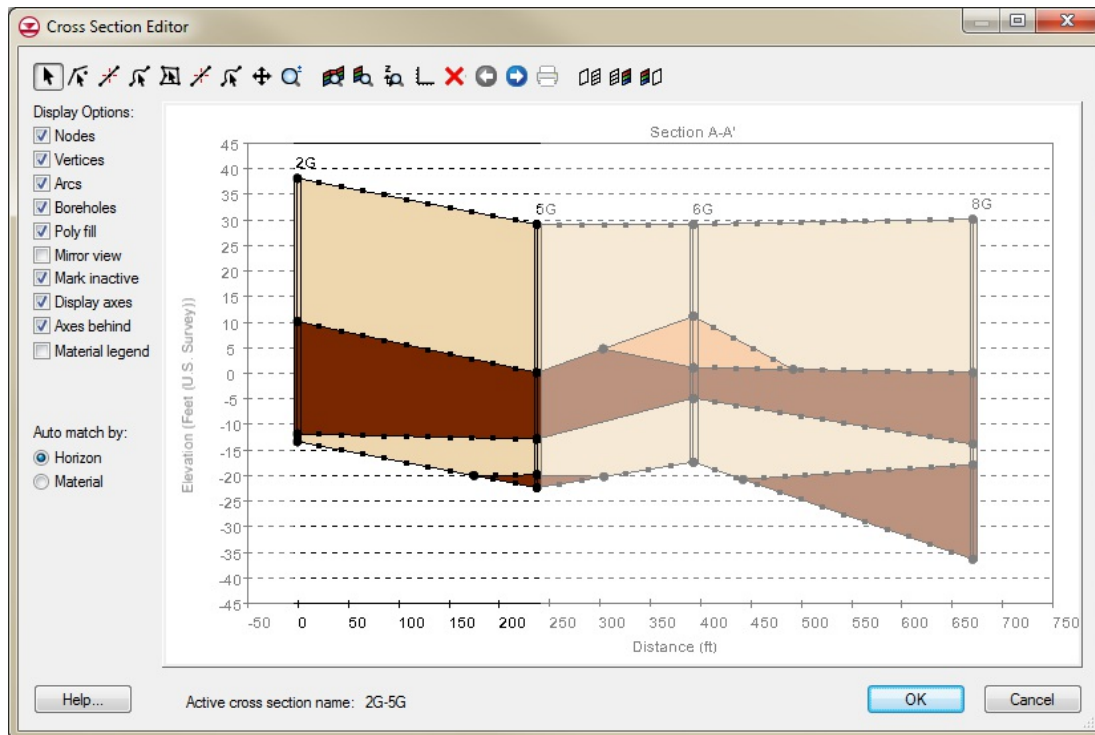















Borehole Cross Section Editor

The *Cross Section Editor* can be used to manually construct and view cross sections between boreholes. The *Cross Section Editor* in GMS 6.5 has been updated to allow for the display and editing of multiple borehole cross sections. The *Cross Section Editor* has a set of tools and toggles used to create, edit, and view the cross sections. The tools used to create the nodes, polylines, and polygons are similar to the tools available in the [Map module](#) used to create feature objects (points, arcs, and polygons). The following tables describe the tools and display options available in the *Cross Section Editor*.



The Cross Section Editor dialog

Tools

Tool	Tool Name	Description
	Select Tool	Generic selection tool that selects nodes, vertices, arcs, and polygons
	Select Point/Node	Selection tool that will only select points or nodes
	Select Vertex	Selection tool that will only select vertices
	Select Arc	Selection tool that will only select arcs
	Select Polygon	Selection tool that will only select polygons
	Create Vertex	Creates new vertices along arcs within the cross section
	Create Arc	Creates arcs between two nodes or vertices within the cross section
	Pan	Pans in the viewing area of the Graphics Window
	Zoom	Magnifies or shrinks the current viewing area
	Frame All Cross Sections	Frames to the extents of all the cross sections
	Frame Current Cross Section	Frames to the extents of the current cross section
	Z-Magnification	Adjusts the Z-Magnification factor to increase or decrease the graphical display along the Y (real world Z) axis, making more or less room at the top and bottom of the screen while maintaining the boreholes and cross sections in the middle of the screen
	Plot Options	Adjusts the axes plot options, including: title, background color, font, font color, grid display, axes titles, and axes display
	Delete	Deletes the currently selected vertices, nodes, arcs, or polygons
	Left	Activates the cross section to the left of the current cross section as the current cross section
	Right	Activates the cross section to the right of the current cross section as the current cross section
	Print	Prints the current Graphics Window
	Auto-Match Cross Section	Creates a set of straight arcs connecting matching contacts on adjacent boreholes based on the selection to use Horizons or Materials
	Build Cross Section Polygons	Deletes all current polygons, builds new polygons using all of the arcs, and checks to see if every polygon built is valid. A polygon is valid only if it contains either one arc representing a borehole region or two arcs representing two matching borehole regions on two holes. Thus, every valid polygon can be assigned one and only one material type. If every polygon built is valid, the Color Fill toggle will be automatically turned on and all polygons built will be filled with the color representing the material they are assigned. Otherwise, a dialog saying "Invalid polygons present" will pop up and all polygons built will be deleted.
	Delete All	Deletes all of the vertices, nodes, arcs, and polygons in the current cross section

Display Options

Display Toggle	Description
<i>Nodes</i>	Controls the display of the nodes in the graphics window
<i>Vertices</i>	Controls the display of the vertices in the graphics window
<i>Arcs</i>	Controls the display of the arcs in the graphics window
<i>Boreholes</i>	Controls the display of the arcs in the graphics window
<i>Poly fill</i>	Controls the display of the polygons in the graphics window
<i>Mirror view</i>	Reverses the order in which the cross sections are displayed
<i>Mark inactive</i>	Dims the inactive cross sections
<i>Display axes</i>	Controls the display of the plot axes in the graphics window
<i>Axes behind</i>	When checked, the axes are drawn behind the cross section. When unchecked, the axes are drawn on top of the cross section.
<i>Material legend</i>	Controls the display of the material legend

Borehole Commands

When the Borehole module is active the *Borehole* menu become active. The menu has the following commands:

New Borehole

Creates a new Borehole.

Borehole Editor...

Opens the *Borehole Editor*.

Cross Section Editor...

Brings up the *Cross Section Editor* dialog where one or multiple 2D cross sections between boreholes are filled.

Lock All Boreholes

Turns off the ability to change the position (drag) of created boreholes.

Auto Select Contacts/Segments...

When one contact or segment is selected, automatically selects matching contacts or segments on other boreholes.

Auto-Create Blank Cross Sections...

Automatically connects boreholes with blank borehole cross sections.

Auto-Assign Horizons...

Automatically assigns horizon IDs to borehole contacts based on material ordering and adjacent boreholes.

Auto-Fill Blank Cross Sections...

Automatically fills all blank cross sections by connecting the contacts on one borehole to those on the other.

Horizons → Solids...

Opens the *Horizons to Solids* wizard which can be used to create **solids** from a combination of boreholes, TINs and conceptual models.

Horizons → 3D Mesh...

Opens the *Horizons to Mesh* wizard which can be used to create a **3D mesh** from a combination of boreholes, TINs and conceptual models.

Horizons → UGrid

Opens the *Horizons to UGrid* wizard which can be used to create a UGrid from a combination of boreholes, TINs and conceptual models.

Zoom To Extents

Frames the Graphics Window around the selected objects.

Advanced >

HGUs → Soils

Copies the HGU material IDs to the soil IDs, overwriting the existing soil IDs.

Soils → HGUs

Copies the soil material IDs to the HGU IDs, overwriting the existing HGU IDs.

Snap Cross Sections to TIN...

Opens a dialog that allows snapping the top and/or bottom arcs of the cross sections to TINs.

Snap Boreholes to TIN...

Opens a dialog that allows selecting a TIN. The selected boreholes (or all, if none are selected) are moved up or down in the Z direction such that their tops just touch the TIN surface. Multiple TINs can be selected. If a borehole can be snapped to more than one TIN, it will be snapped to whichever TIN is last.

Add Contacts to TIN

Inserts a new vertex into the active TIN at the location of every selected borehole contact.

Bounding 3D Grid...

Opens the *Create Finite Difference Grid* dialog with dimensions defaulted such that the new grid will surround all existing boreholes.

Contacts → TIN

Creates a new TIN with vertices at the locations of the selected contacts.

Contacts → 2D Scatter Points...

Creates a new 2D scatter point set with vertices at the locations of the selected contacts.

Watertable → 2D Scatter Points...

Creates a new 2D scatter point set with vertices at the locations of the water

table specified on each borehole.

Sample Data → 3D Scatter Points...

Brings up the *Sample Data → Scatter Points* dialog that is used to create a 3D scatter point set from sample data.

Sample Data → Stratigraphy

Opens the *Sample Data → Stratigraphy* dialog that allows defining stratigraphy (borehole contacts) based on the sample data.

Horizons → HUF

Opens the *Horizons → HUF* wizard to create **MODFLOW HUF** data from TINs and boreholes. TINs or boreholes with horizon data defined are required, along with a MODFLOW simulation which uses the HUF package.

Related Topics

- [Boreholes](#)

5.2.1. Horizons

Horizons

The term “horizon” refers to the top of each stratigraphic unit that will be represented in a corresponding Solid, HUF unit, or 3D Mesh Layer. Horizons are numbered consecutively in the order that the strata are “deposited” (from the bottom up). Horizons can be assigned to [Boreholes](#), [TINs](#), and [Coverages](#). Beginning with version 9.0, [raster catalogs](#) can also be used to define horizons.

Once horizons have been assigned to boreholes, TINs, and/or [Rasters](#), the [Horizons Wizard](#) can be used to create solids, 3D mesh, or HUF data.

Assigning Horizons to Boreholes

On boreholes, horizons are defined at borehole contacts. Each contact included in the construction of the solid must have a non-zero horizon ID. If wanting to ignore a contact, this can be done by leaving the horizon ID set to zero. Horizons are numbered in the order that the strata are “deposited” (from the bottom up). Gaps can exist in the horizon numbering. For example, horizons can be assigned using 1, 2, 3, etc..., or assigned horizons using 10, 20, 30, etc... . Using larger numbers with gaps can be useful if more horizons are added at a later time.

Automatic Assignment

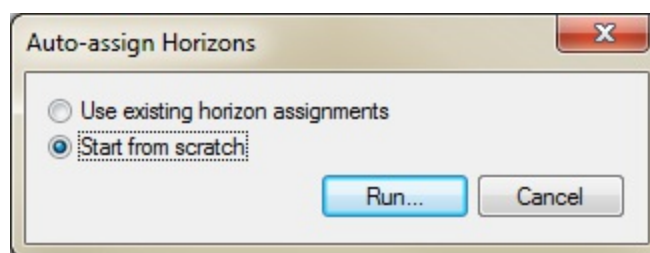

The Auto-assign Horizons dialog

To have GMS automatically assign horizon IDs to boreholes, use the [Boreholes | Auto-](#)

Assign Horizons menu command. Depending on the number and complexity of the boreholes, this command can take a considerable amount of time.

The *Auto-assign Horizons* dialog has two options:

- *Use existing horizon assignments*
- *Start from scratch*

Selecting **Run** in the *Auto-assign Horizons* dialog will start the *Horizon Optimizer* model wrapper. With bigger and more complex sets of boreholes, the optimizer can take a significant amount of time.

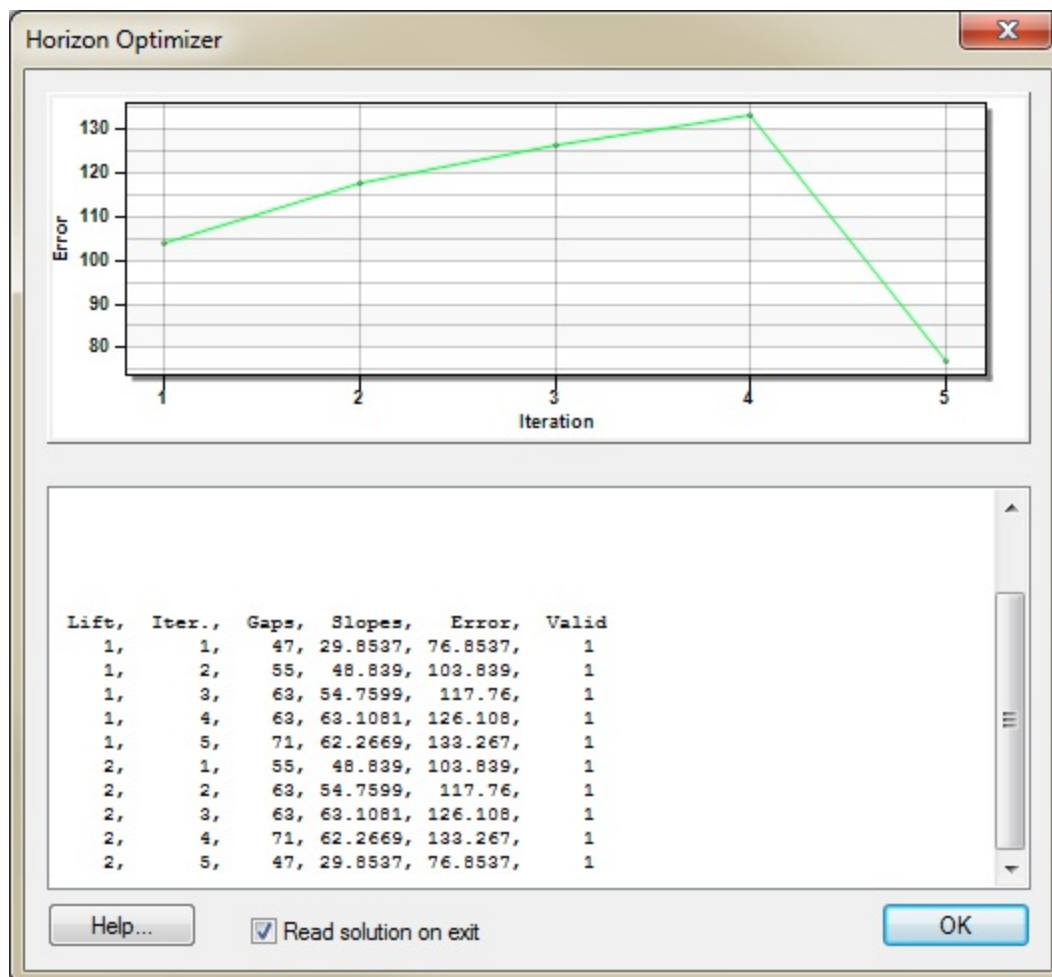

The Horizon Optimizer

Manual Assignment

Horizons are defined at borehole contacts (interface between different materials on a

borehole log) by double-clicking on a contact with the **Select Contact** tool. The *Contact horizon ID* dialog is used to manually enter horizon IDs. More than one contact can be selected and assigned the same horizon ID. The *Boreholes | Auto Select* command can be helpful in assigning horizons to a large group of boreholes.

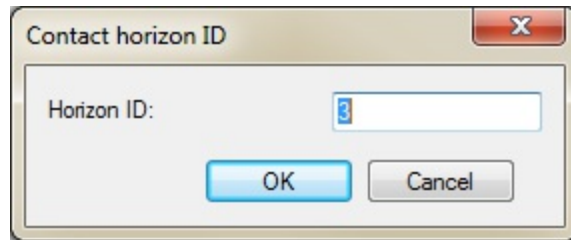

The Contact horizon ID dialog

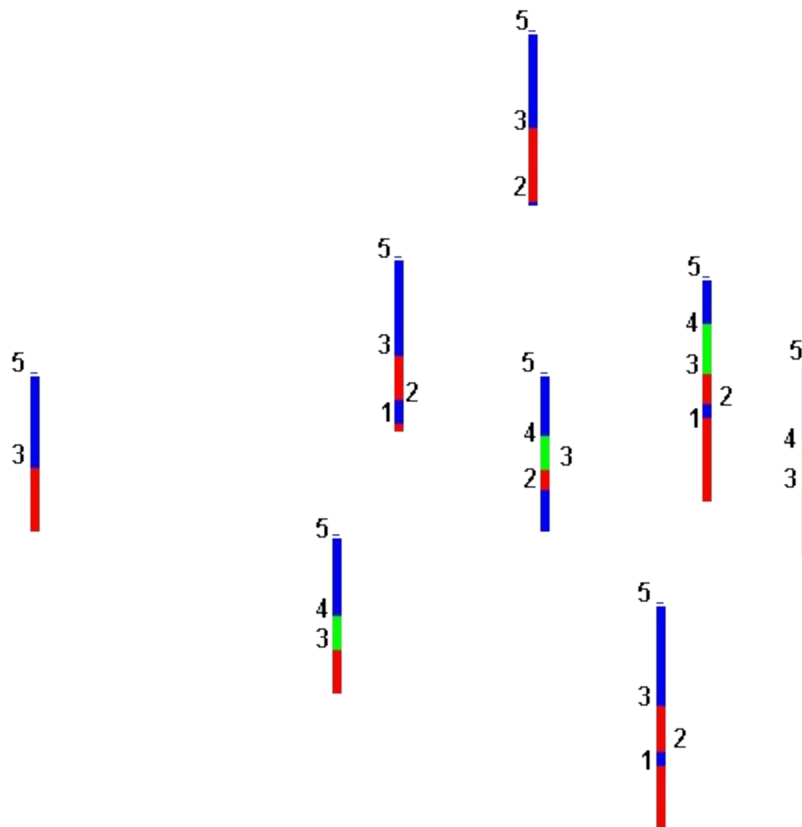

Horizons assigned to contacts on boreholes

Assigning Horizons to TINs

A TIN horizon is assigned in the TIN *Properties* dialog. This dialog can be accessed by right-clicking on a TIN in the [Project Explorer](#) and selecting the properties command. Each TIN can be assigned one Horizon ID. Each TIN included in the horizons algorithm must have a horizon ID. If wanting to ignore a TIN, this can be done by setting the horizon ID to zero.

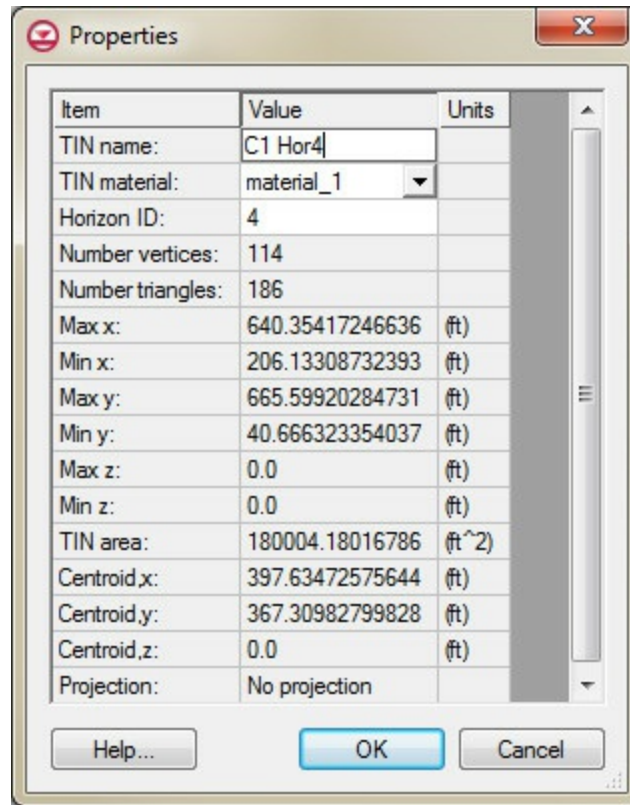

Horizons assigned to contacts in TIN Properties dialog

Assigning Horizons to Rasters

Raster can also be used to define horizons. See the [Raster Catalog](#) page for more information on using rasters with horizons.

Horizon Conceptual Model

If wanting to explicitly control the areal extent of a solid created from horizons, this can be done using horizon coverages. GMS has a conceptual model type for horizons. Coverages that are inside of a horizon's conceptual model can be associated with a horizon ID. The polygons in a horizon coverage determine the areal extent of the solid for the associated horizon. The first figure below shows a horizon coverage for the green material. The solid associated with this horizon will not extend beyond the boundary of the polygon. The second figure shows the solid resulting from the boreholes and the horizon coverage. When the **Horizons** → **Solids** command is executed it is possible to include a Horizons conceptual model as part of the input to the command.

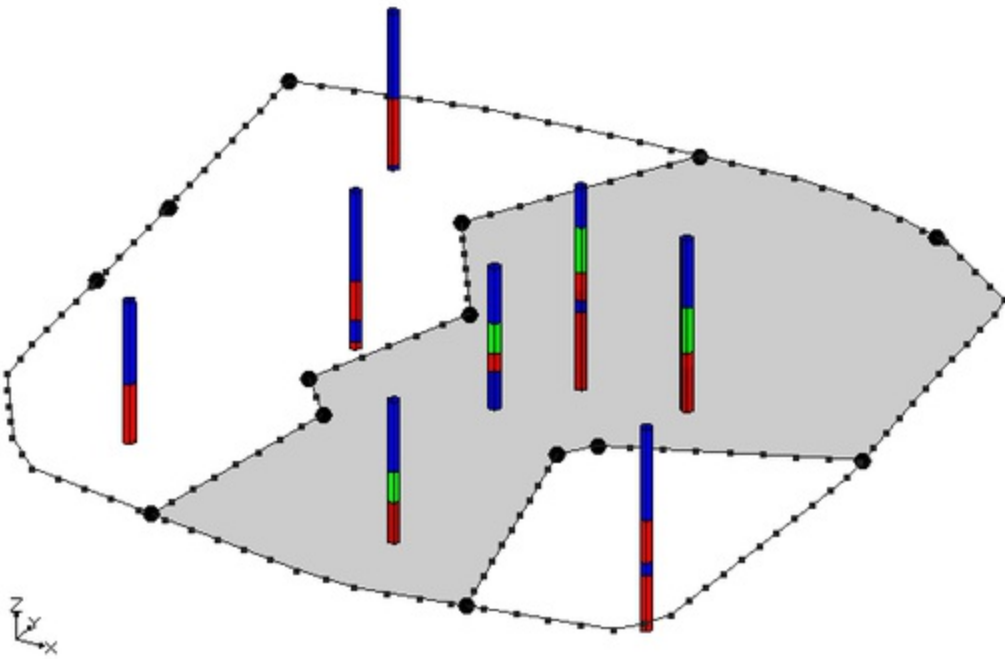

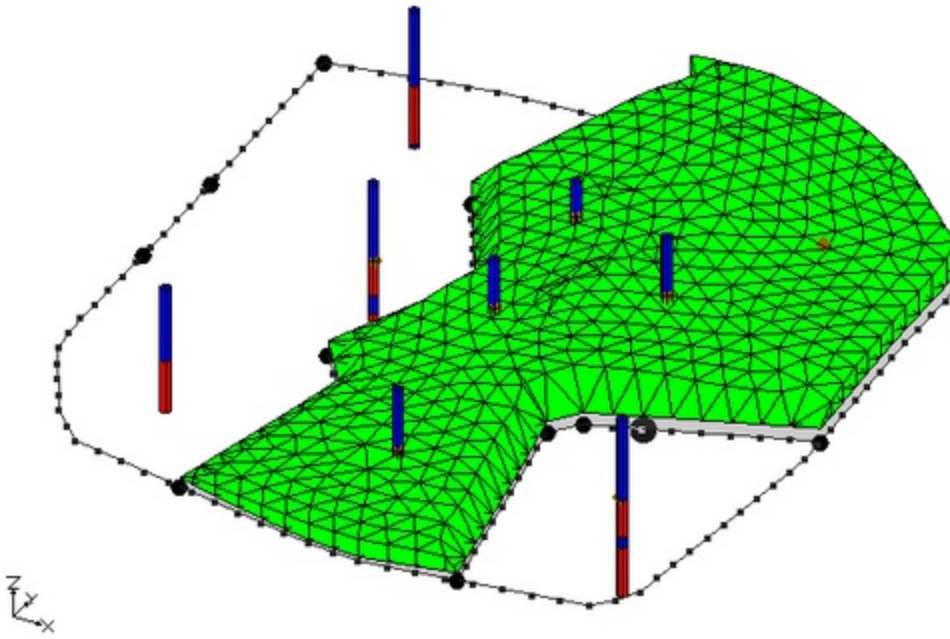

The Horizons algorithm is used to create either solids, HUF units, or 3D Meshes from Borehole and TIN data. How to use the three Horizon commands are explained in more detail below:

- [Horizons to Solids](#)
- [Horizons to 3D Mesh](#)
- [Horizons to HUF](#)

Build Horizon Coverages

The right-click menu for the horizon conceptual model contains the **Build Horizon Coverages** command. This command will bring up the *Build Horizon Coverages* wizard. All Horizon IDs must have been assigned to boreholes and there must be a coverage with a polygon before the *Build Horizon Coverages* wizard can be used. The wizard will offer options for which boreholes to use, which boundary coverage to use, and which horizons to generate. After running the wizard, horizons will appear as new coverages in the Project Explorer.

Horizons Applications

The horizons method has been applied at a variety of sites to construct solid models of the subsurface. This page highlights example applications of the Horizons Method.

Modeling a Slope Failure

In this example, a combination of boreholes, user-defined cross sections, and TINs were used to create solids at a site with a slope failure.

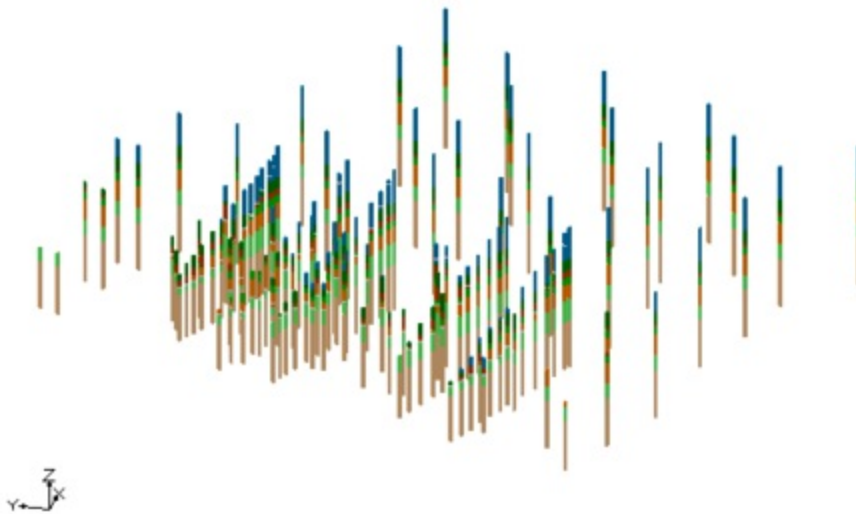

Borehole data

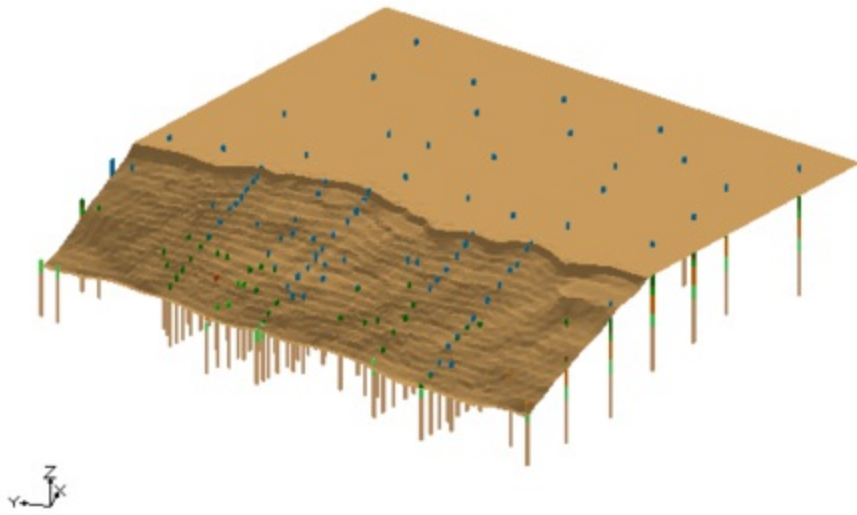

Surface elevations

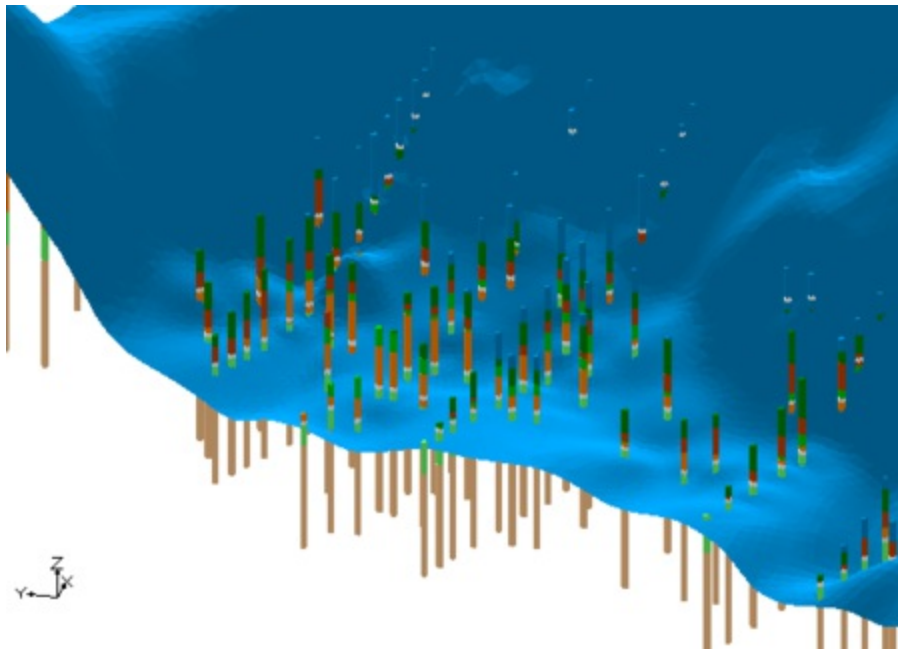

Failure surface

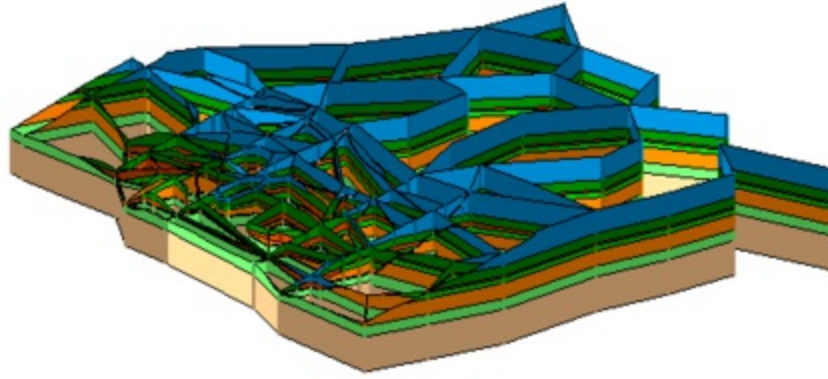

User defined cross sections

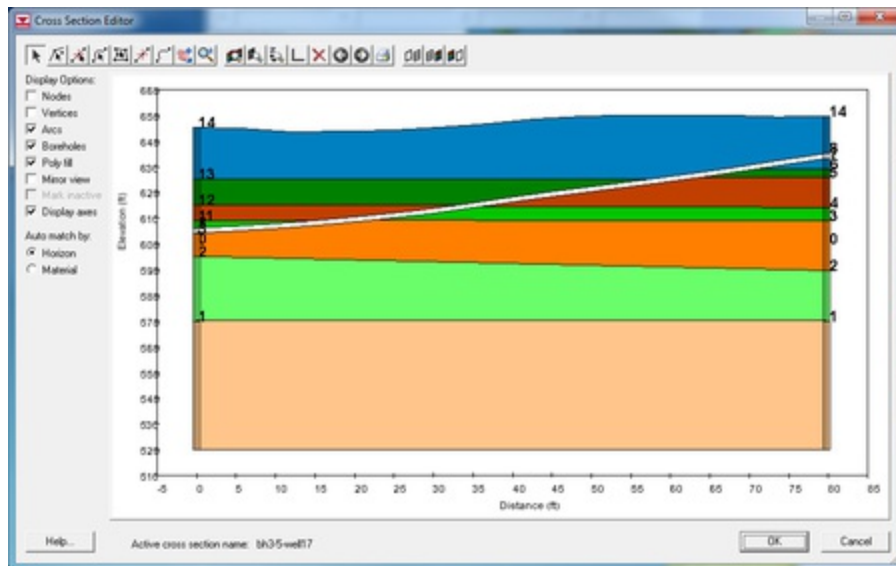

One user cross section

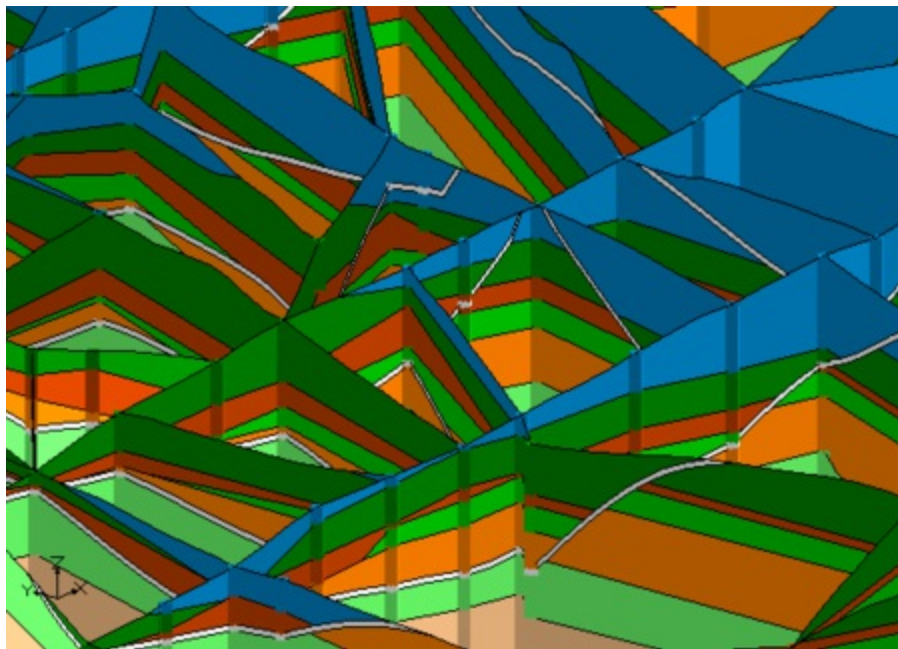

Zoomed in on cross sections

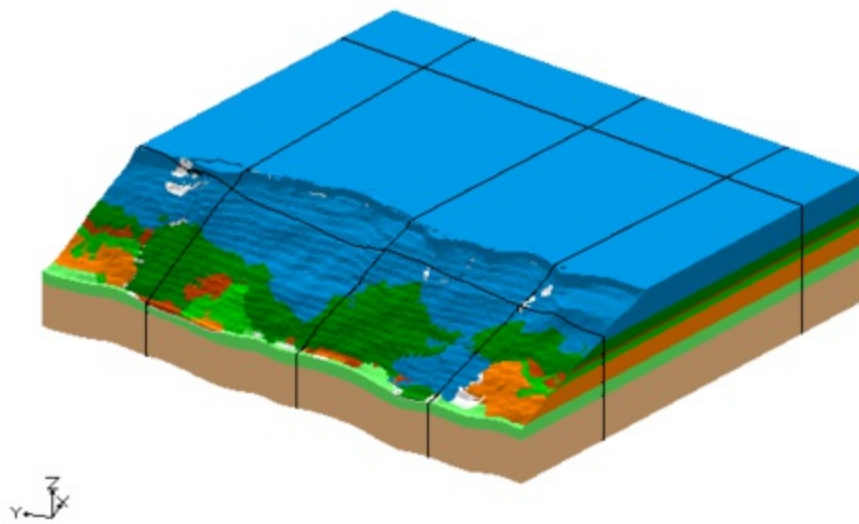

Solids created from user data

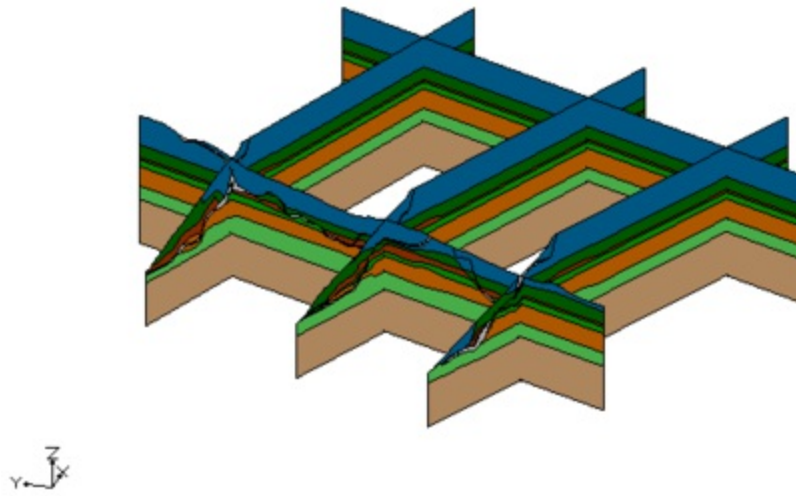

Cross sections from solids

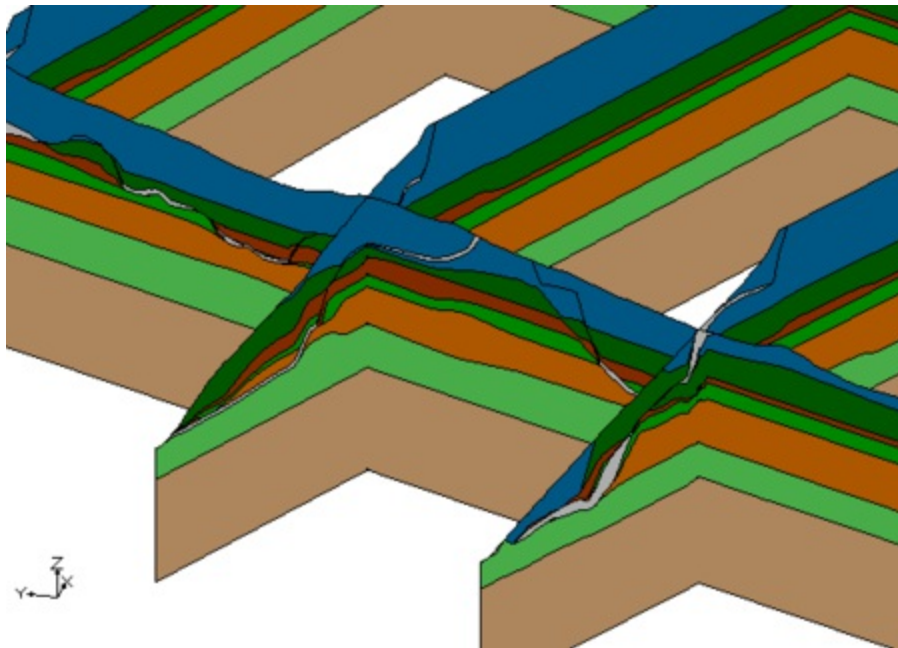

Zoomed in on cross sections

Vertical Boundary Between Solids

In this application, the project required creating a set of solids where there would be distinct materials below a river bed compared to the other materials in the study area. The

following cross section shows what project wanted to create.

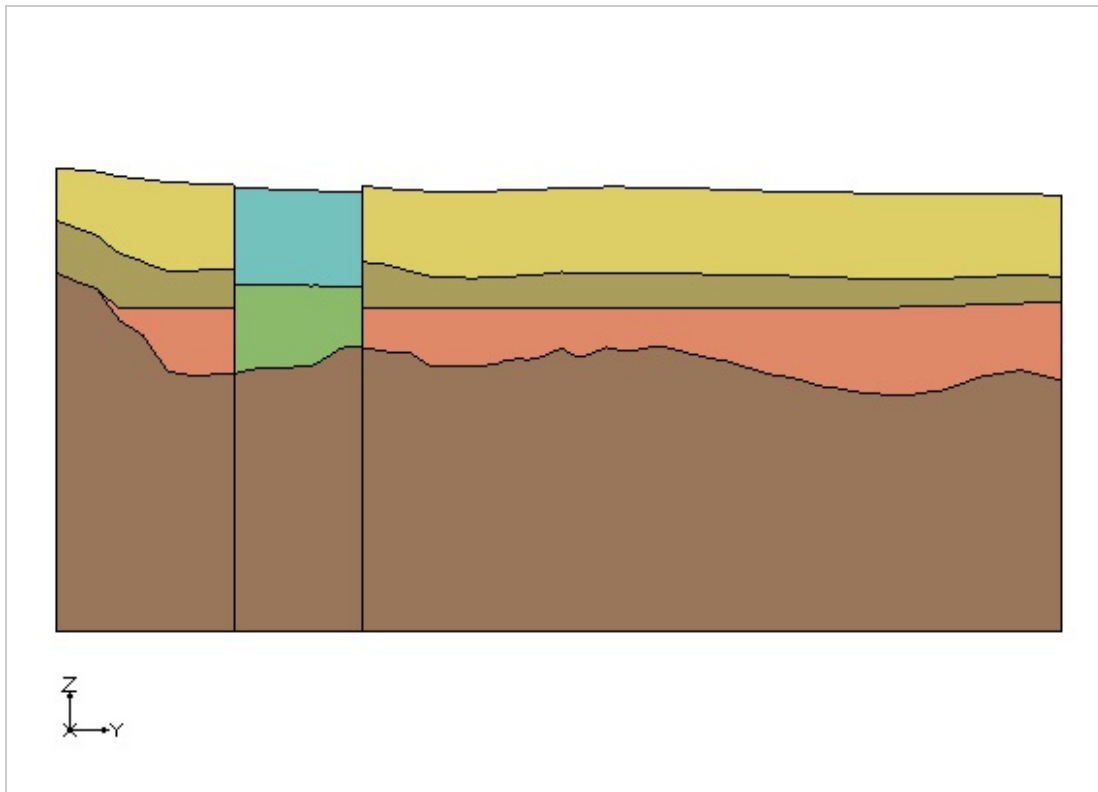

Primary TINs

To create solids that would match this cross section, create two different primary tins and executed the **Horizons**→**Solids** command for each primary TIN. The first TIN covered the area of the river and the second TIN covered the remainder of the study area as show in the images below.

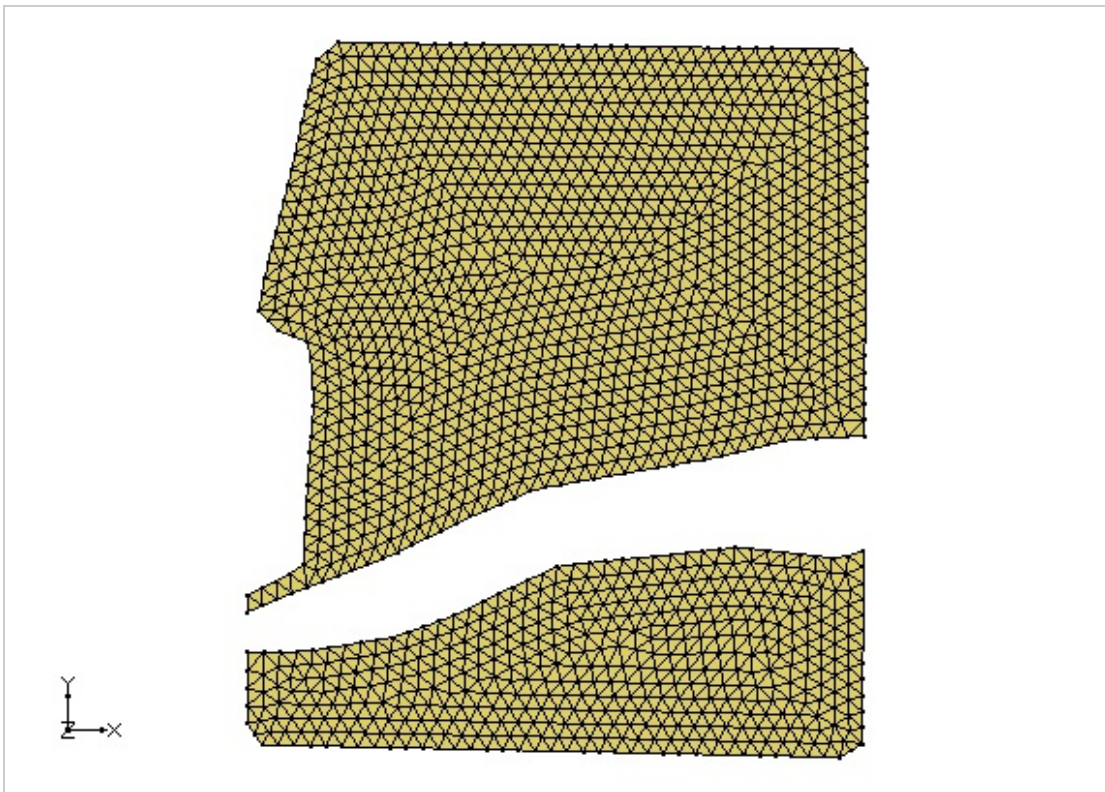
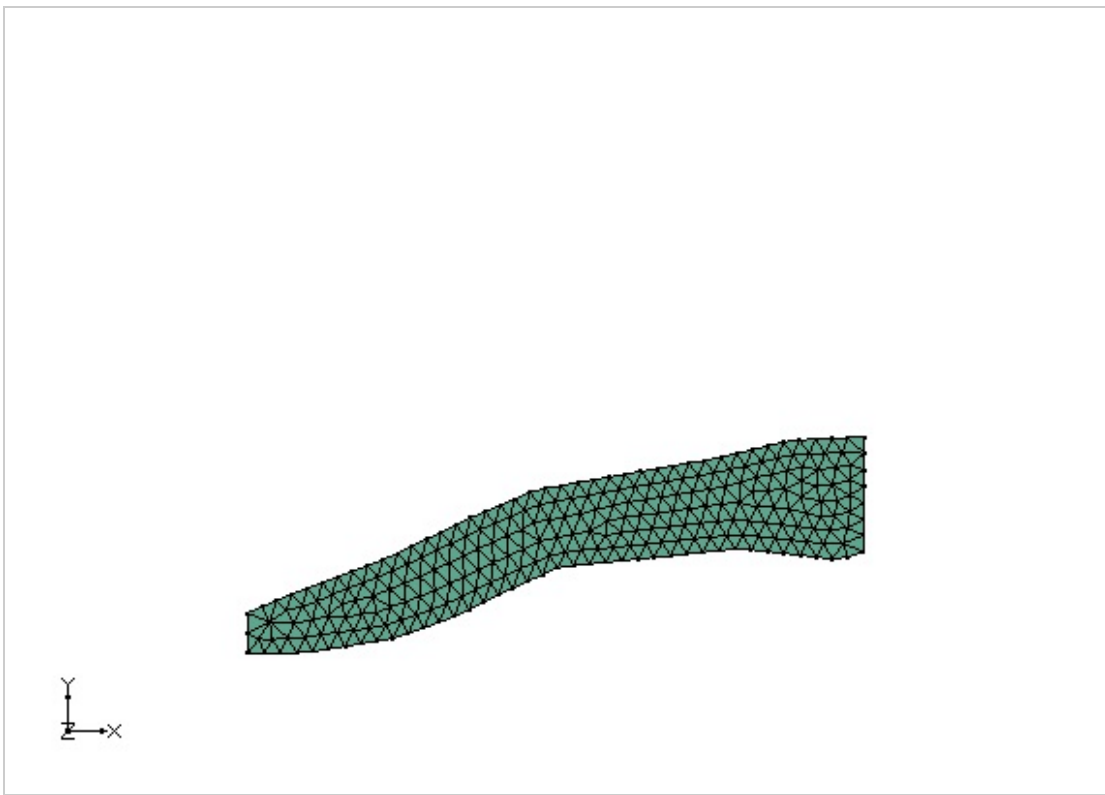

Solids

There are now TINs that defined the top elevations of the horizon surfaces. There were three TINs used in the area around the river and there were four TINs used the remainder of the study area. Solids were created for the river area using the first TIN as the primary TIN. Solids were also created in remainder of the study area by using the second TIN as the primary TIN. Solids were also created in remainder of the study area by using the second TIN as the primary TIN. Notice the the bottom most material matches in both sets of solids. This is because the same TIN with that horizon was used when creating both sets of solids.

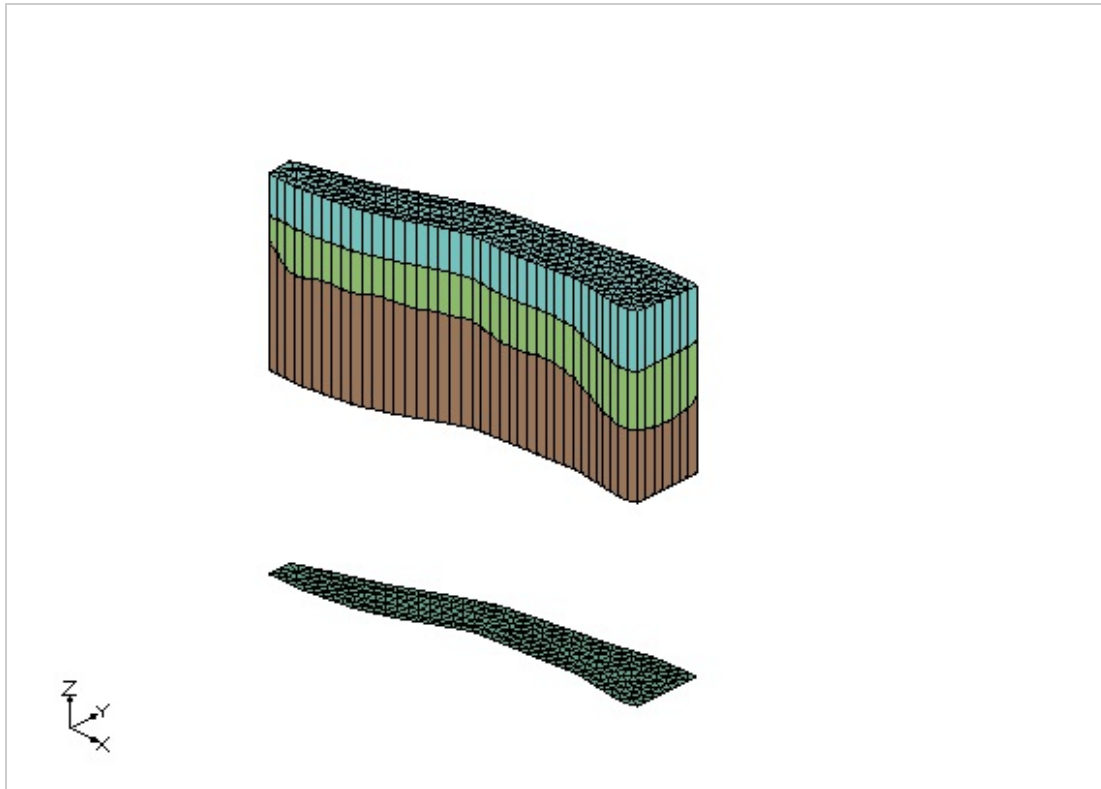

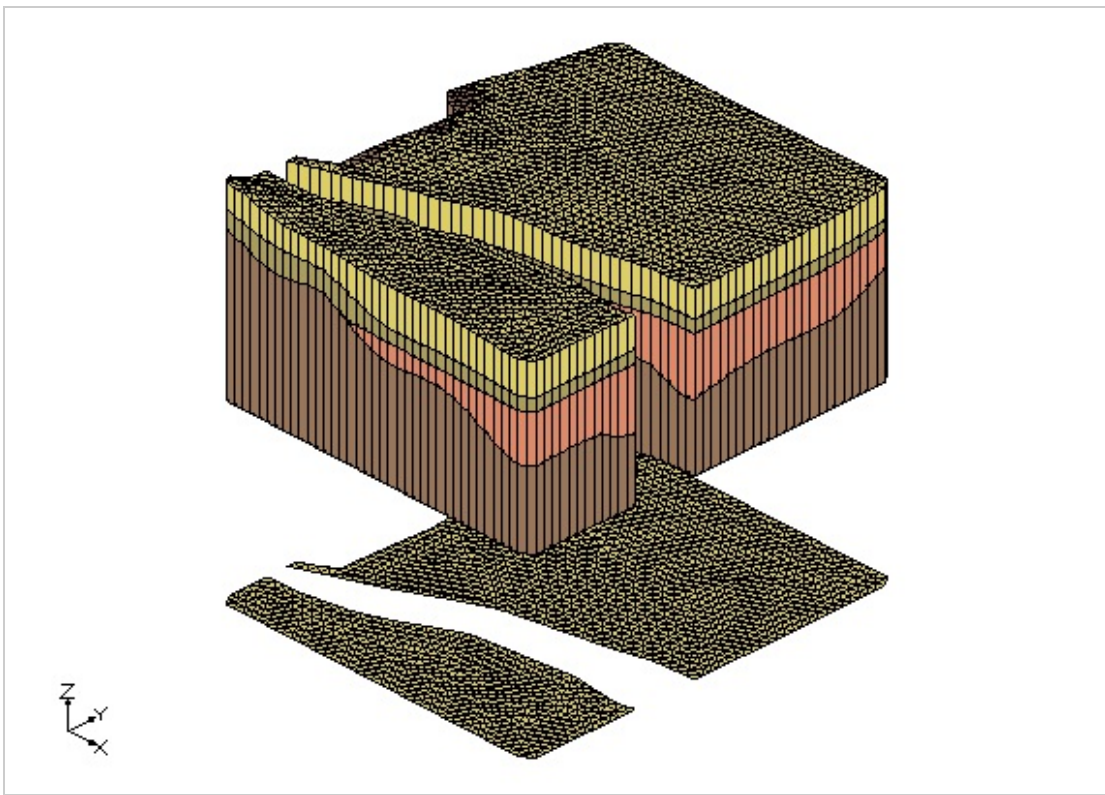

Cross Sections from Solids

These images show the solids together and cross section cut through the solids. Again notice how the bottom most material matches across both sets of solids.

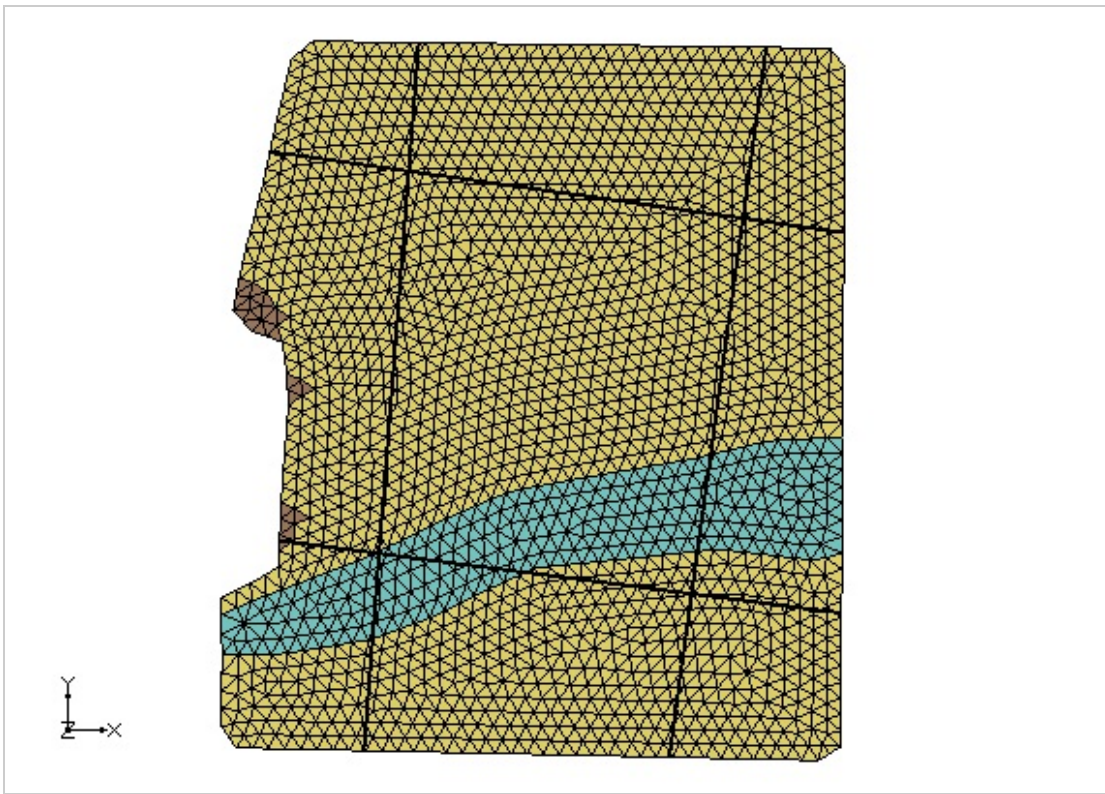
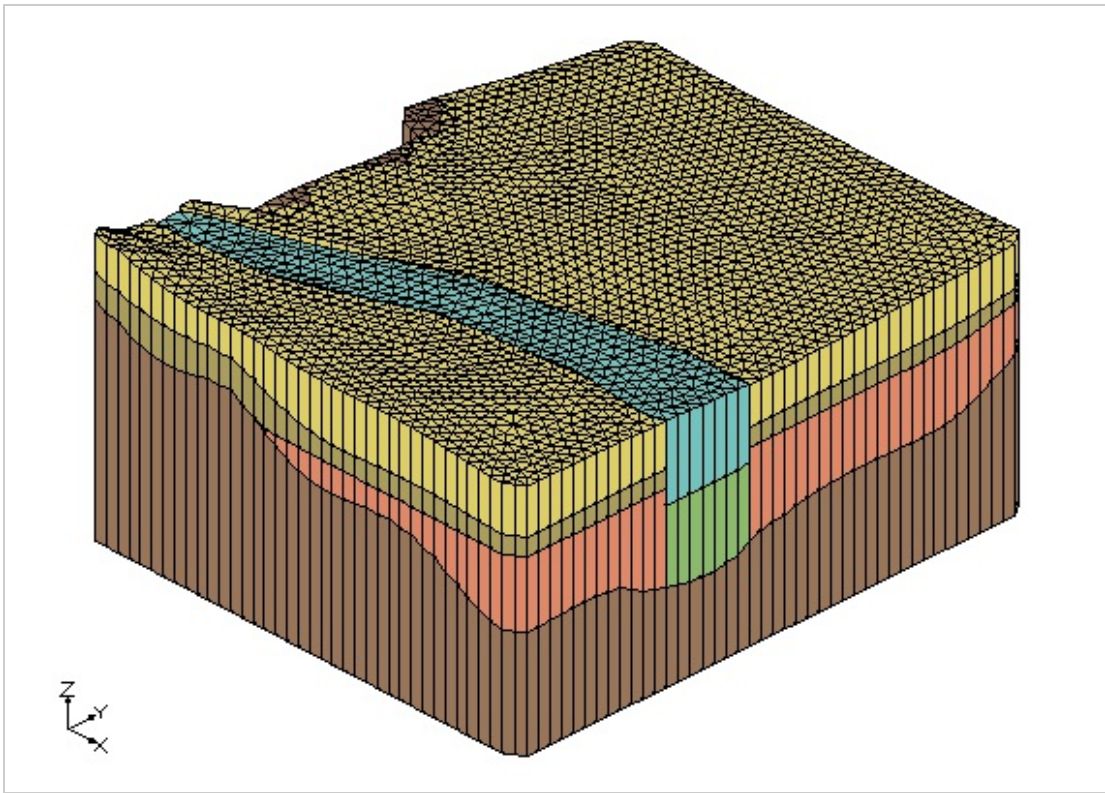

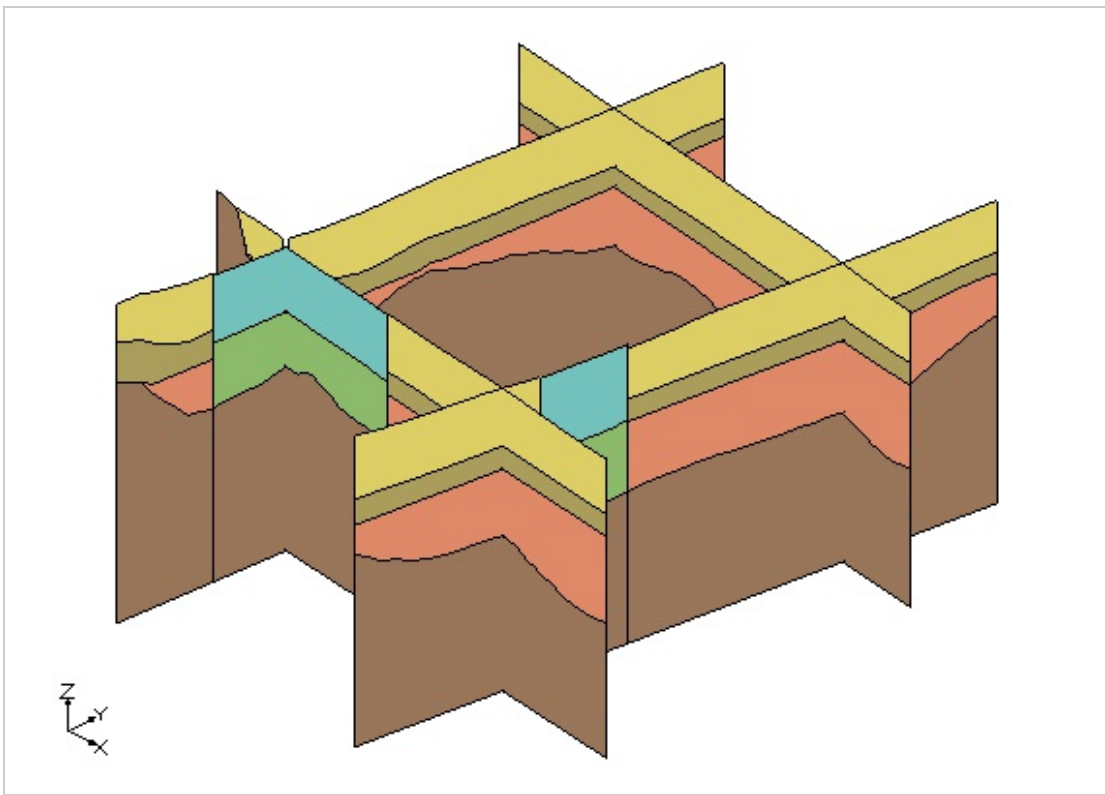

Horizons Wizard

The *Horizons Wizard* is used to create [solids](#), a [3D mesh](#), or [HUF](#) layers from [horizon](#) data. The wizard is started via the [Horizons → Solids](#), [Horizons → 3D Mesh](#), [Horizons → UGrid](#), and [Horizons → HUF](#) commands. These commands are in the *TIN* and *Boreholes* menus.

Step 1

The first step is to define the inputs to be used, which can include [boreholes](#), [TINs](#), and a [Horizon Conceptual model](#).

Beginning with *GMS 9.0*, a [raster catalog](#) can be included as input.

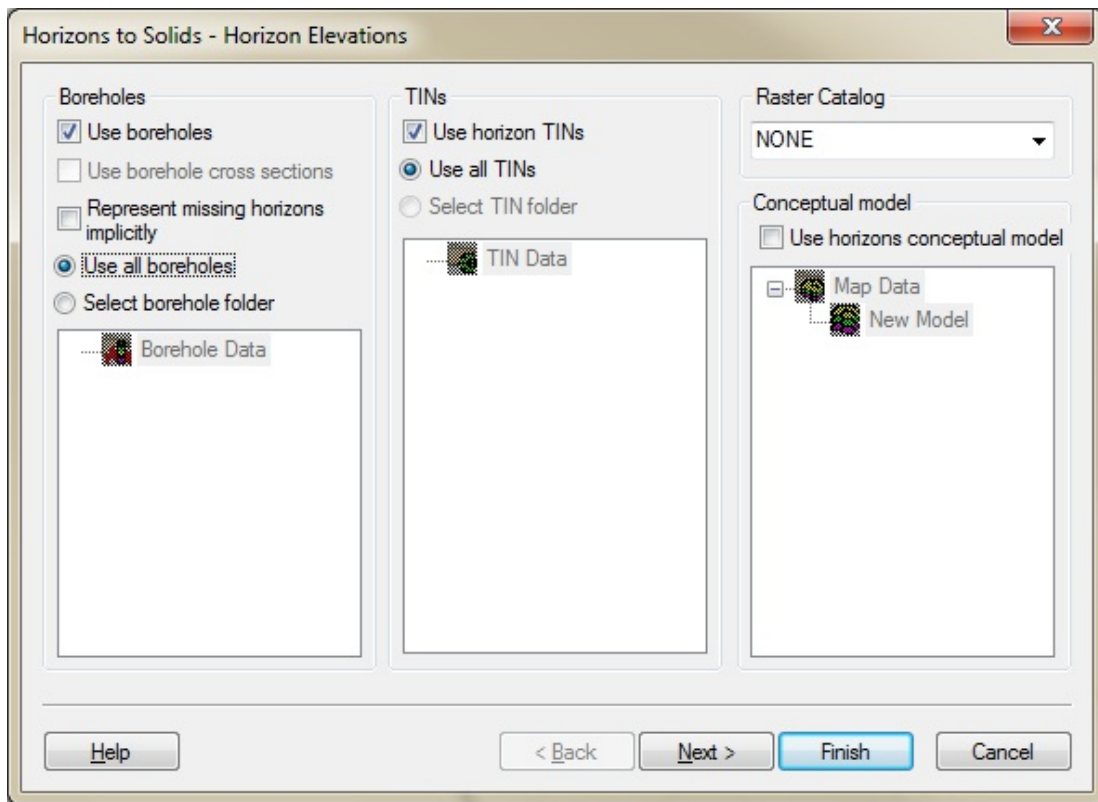

The Horizon Elevation step of the Horizons wizard

Step 2

The second step is to define the top and bottom of the solid, mesh, or HUF layers. When creating HUF data, the grid elevations can be edited.

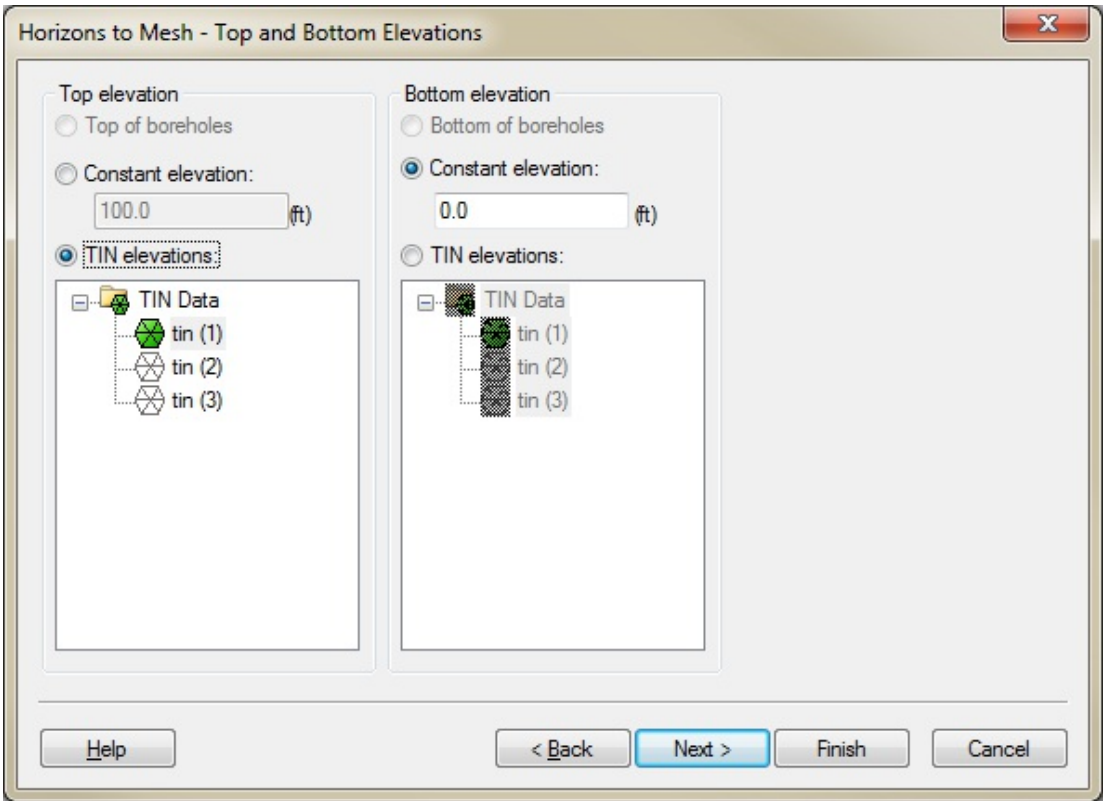

The Top and Bottom Elevations step of the Horizons wizard

Step 3

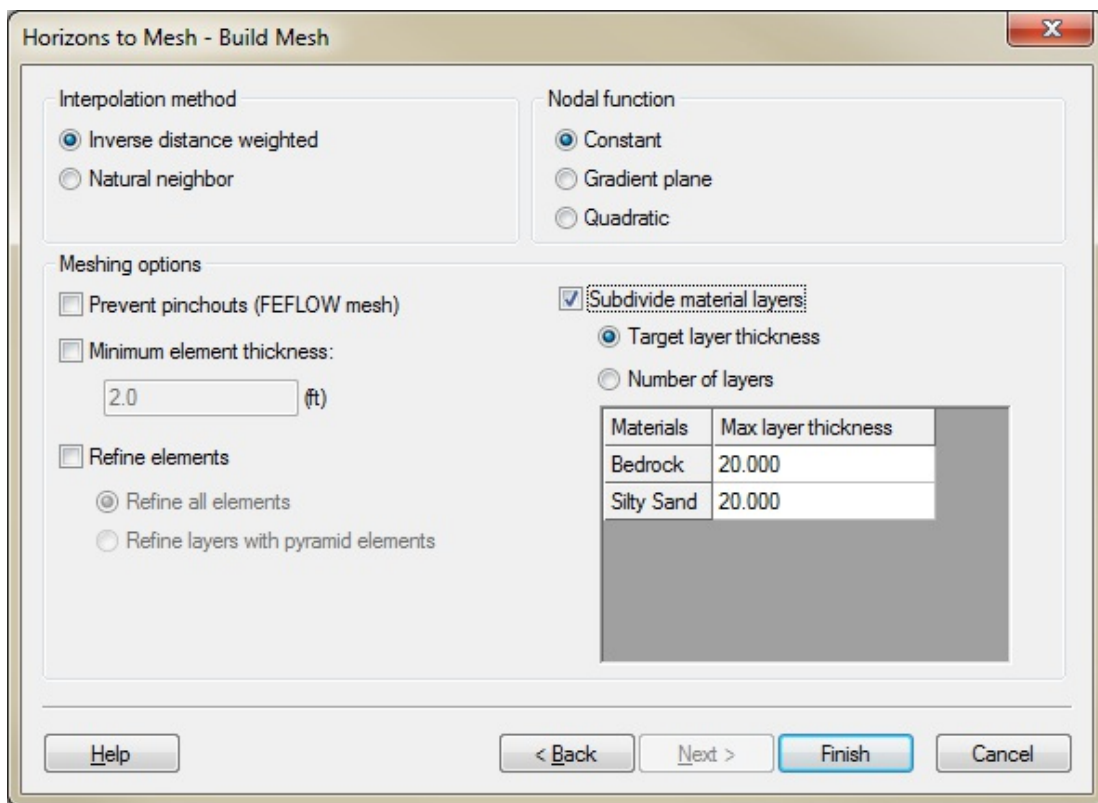

The Build Mesh step of the Horizons wizard

The third step is to define the [interpolation](#) method to be used, as well as options specific to creating solids, a mesh, or HUF package.

Beginning with GMS 7.0, when creating solids, the user can choose the option *Preserve projection TIN datasets*. This option will create a new TIN that will have a dataset for each horizon. This is often useful so that the user can see the result of the interpolation process for each Horizon. The user can then edit the TIN by hand and include the TIN when executing the **Horizons**→**Solids** command.

When creating a 3D mesh for a FEFLOW simulation, make sure to turn on the *Prevent pinchouts (FEFLOW mesh)* option. This will ensure that the mesh will contain all prism elements and that every mesh layer is continuous throughout the mesh.

Including Borehole Cross Sections

If the Horizon process using horizons on borehole contacts does not produce the desired results, the borehole data can be supplemented with [user-defined cross sections](#) using the [Cross Section Editor](#).

For example, when the **Horizons** → **Solids** command is executed, the user can choose to include cross section data. If this option is selected, the material boundaries (arcs) on the cross sections inherit the horizon ID assigned to the adjacent borehole contact and the points along the material boundary are added to the contacts when interpolating the horizon surfaces. The resulting solids match the user-defined cross sections as closely as possible. In other words, by creating a few simple cross section, the user has complete control over the shape of the solids created by the horizons technique.

The match between the resulting solid and the user defined cross section is a function of two things: first, the density of the points on the user defined cross section, and second the triangle density of the primary TIN. As mentioned, the arcs on the cross sections inherit the horizon ID from the borehole contact as shown below.

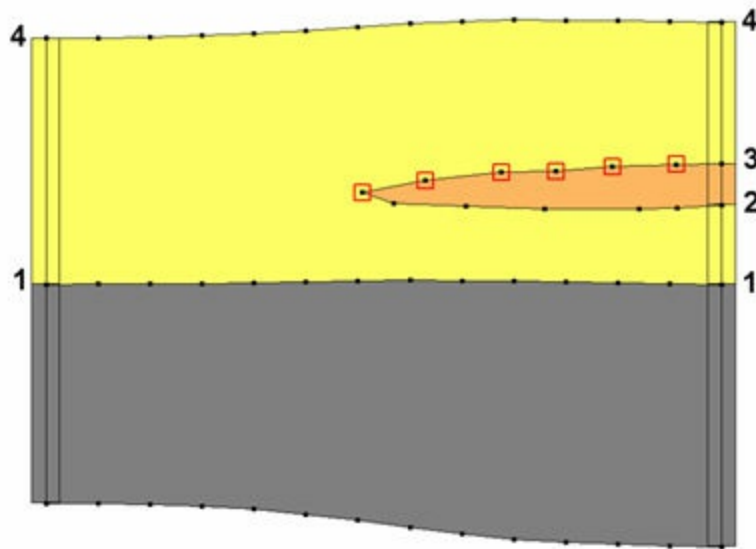

Example of how cross section data inherits horizon ID from boreholes

In this case, the marked points on the cross section inherit horizon ID 3. If wanting more

control over the interpolation of horizon 3, then add more points to the arc. This can be done by selecting the **Select Arc** tool's right-click **Redistribute Vertices** command in the *Cross Section Editor*. The triangle density of the primary TIN also controls how well the resulting solid matches the user-defined cross section. Since the points on the cross section are interpolated to the primary TIN, if the TIN does not have a significant number of triangles in the vicinity of the cross section then there is no way the TIN surface can match the cross section.

Horizons to HUF

The following steps illustrate how to use the [Horizons](#) method to create HUF data:

- 1. Create/Import Inputs** – There are two main types of inputs for the horizons method:
 - 1. Boreholes** – Boreholes can be created by importing borehole data by using the [File Import Wizard](#), importing sample data after boreholes already exist, or using the borehole tools to manually enter the boreholes. Once a borehole has been created it can be edited in the *Borehole Editor* or by using the borehole tools. Also an existing borehole can be copied. Boreholes can be locked to prevent them from being edited.
 - 2. TINs** – TINs can be created 3 different ways in GMS: manually entering the vertex locations and triangulating, converting a different GMS data type to a TIN, and copying a currently existing TIN. (See [Creating TINs](#))
 - 3. Raster Catalog** – A set of rasters defining the top of each horizon (available beginning in version 9.0).
- 2. Assign Horizon IDs** – The term “horizon” refers to the top of each stratigraphic unit that will be represented in a corresponding solid, HUF unit or material layer. Horizons are numbered consecutively in the order that the strata are “deposited” (from the bottom up). Horizons can be assigned to both boreholes and TINs. (See [Horizons](#))
- 3. Create 3D Grid/MODFLOW model** – A 3D grid and MODFLOW model need to be first created to use the **Horizon rarr; HUF** command. The flow package for the MODFLOW model must also be set to use the HUF package. Before building a MODFLOW simulation, a [3D grid](#) must be created which covers the area to be modeled. A grid can be created by selecting the **Create Grid** command in the *Grid* menu. A suite of tools and commands for editing grids (inserting rows, changing column widths, etc.) are also provided in the 3D Grid module. If the [conceptual model approach](#) is used to construct a MODFLOW model, the grid can be automatically constructed from the conceptual model data using the **Grid Frame** and the **Map → 3D Grid** command in the *Feature Objects* menu. The grid can be automatically refined around wells and cells outside the model domain can be inactivated.
- 4. Setup additional optional inputs** – Two additional options exist to help constrain and provide user intervention in the horizon modeling process. The two options are to create borehole cross sections or a horizon conceptual model.
 - 1. Including Borehole Cross Sections**

5. **Run the Horizons Wizard** – Select the **Horizons** → **3D Mesh** command in the *Borehole* or *TINs* menu.

Horizon → HUF Algorithm

When the **Horizon** → **HUF** command is executed the horizons specified on the borehole contacts or TIN nodes are converted to a set of scatter points with one dataset for each horizon. The scatter points are then used to interpolate a surface for each horizon. Starting with the lowest numbered horizon, the surface is extruded down to create a HUF layer. The surface corresponding to the next horizon is then extruded down to fill in the space between that surface and the previous surface. This process is repeated for each surface. At each step, HUF layer is created for the current horizon and all previously layers are subtracted from that layer, resulting in an incremental buildup of the stratigraphy from the bottom to the top. In conclusion the HUF package elevation and thickness arrays are generated from the horizon data.

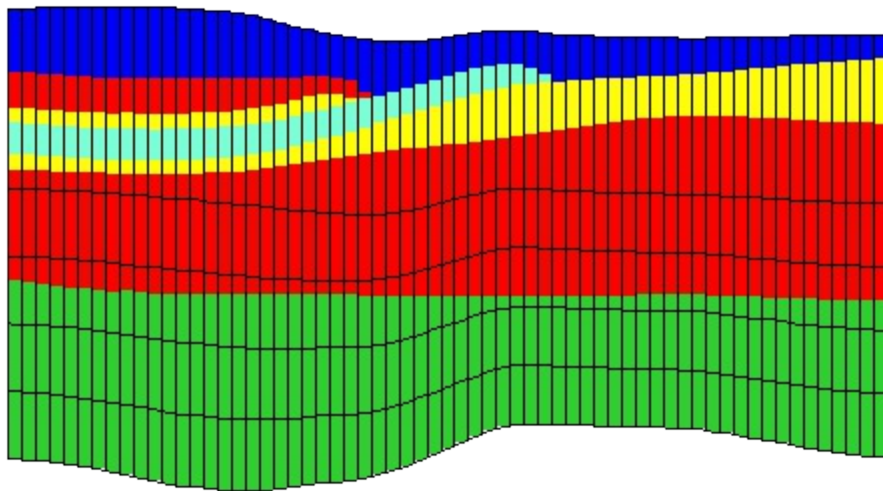

Example of Horizons to HUF

Horizons to Solids

The following steps illustrate how to use the [Horizons](#) method to create solid stratigraphy.

- 1. Create/Import Inputs** – There are two main types of inputs for the horizons method:
 - 1. Boreholes** – Boreholes can be created by importing borehole data by using the [File Import Wizard](#), importing sample data after boreholes already exist, or using the borehole tools to manually enter the boreholes. Once a borehole has been created it can be edited in the *Borehole Editor* or by using the borehole tools. Also an existing borehole can be copied. Boreholes can be locked to prevent them from being edited.
 - 2. TINs** – TINs can be created 3 different ways in GMS: manually entering the vertex locations and triangulating, converting a different GMS data type to a TIN, and copying a currently existing TIN. (See [Creating TINs](#))
 - 3. Raster Catalog** – a set of rasters defining the top of each horizon (available beginning in version 9.0).
- 2. Assign Horizon IDs** – The term “horizon” refers to the top of each stratigraphic unit that will be represented in a corresponding solid, HUF unit or material layer. Horizons are numbered consecutively in the order that the strata are “deposited” (from the bottom up). (See [Horizons](#))
- 3. Create Primary TIN** – A TIN must be created or imported into GMS to be used as the primary TIN for the horizons method. The primary TIN defines the boundary of the solids that will be generated. Also, the density of the triangles in the primary TIN controls the density of the triangles in the solids that are created. (See [Creating TINs](#))
- 4. Setup additional optional inputs** – Two additional options exist to help constrain and provide user intervention in the horizon modeling process. The two options are to create borehole cross sections or a horizon conceptual model.
 - 1. Including Borehole Cross Sections**
 - 2. Horizon Conceptual Model**
- 5. Run the Horizons Wizard** – Select the **Horizons**→**Solids** command in the [Borehole](#) or [TINs](#) menu.

Horizon → Solid Algorithm

When the **Horizon**→**Solids** command is executed the horizons specified on the borehole

contacts or TIN nodes are converted to a set of scatter points with one dataset for each horizon. The scatter points are then used to interpolate a surface for each horizon. Starting with the lowest numbered horizon, the surface is extruded down to create a solid. The surface corresponding to the next horizon is then extruded down to fill in the space between that surface and the previous surface. This process is repeated for each surface. At each step, a solid is created for the current horizon and all previously defined solids are subtracted from that solid, resulting in an incremental buildup of the stratigraphy from the bottom to the top. The entire process is simpler, more intuitive, and more robust than the old set operations approach.

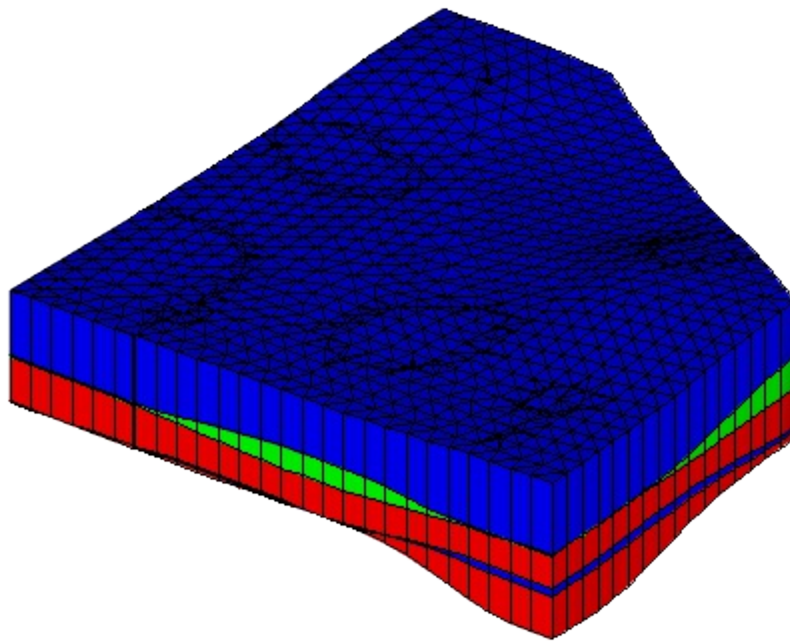

Solids created from the horizons method

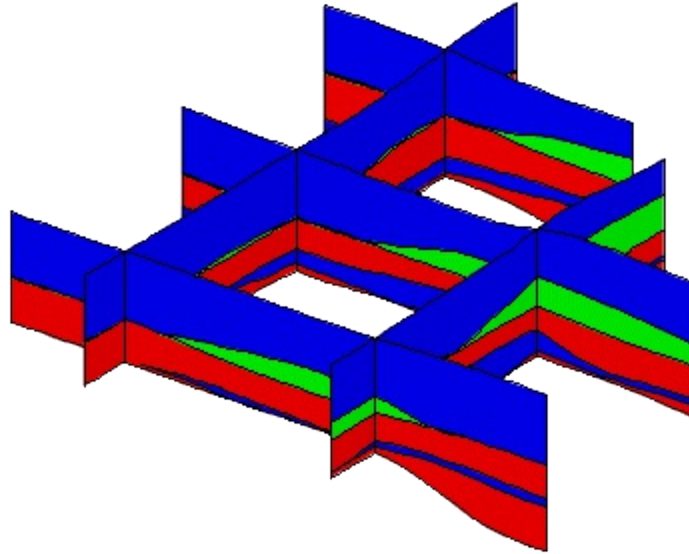

Cross sections from the solid created via the horizons method

Horizons to 3D Mesh

The following steps illustrate how to use the Horizons method to create 3D Mesh stratigraphy.

- 1. Create/Import Inputs** – There are two main types of inputs for the horizons method:
 1. Boreholes – Boreholes can be created by importing borehole data by using the [File Import Wizard](#), importing sample data after boreholes already exist, or using the borehole tools to manually enter the boreholes. Once a borehole has been created it can be edited in the *Borehole Editor* or by using the borehole tools. Also an existing borehole can be copied. Boreholes can be locked to prevent them from being edited.
 2. TINs – TINs can be created 3 different ways in GMS: manually entering the vertex locations and triangulating, converting a different GMS data type to a TIN, and copying a currently existing TIN. (See [Creating TINs](#))
 3. [Raster Catalog](#) – A set of rasters defining the top of each horizon (available beginning in version 9.0).
- 2. Assign Horizon IDs** – The term “horizon” refers to the top of each stratigraphic unit that will be represented in a corresponding solid, HUF unit or material layer. Horizons are numbered consecutively in the order that the strata are “deposited” (from the bottom up). Horizons can be assigned to both boreholes and TINs. (See [Horizons](#))
- 3. Create Primary 2D Mesh** – A 2D mesh is needed to be used as a projection for the resulting 3D mesh. A 2D mesh or a meshing coverage needs to be created and selected as the primary mesh. The 2D mesh defines the boundary of the 3D mesh. Also, the [meshing options](#) assigned to primary coverage controls the elements of the 3D mesh that is created. (See [Creating 2D Meshes](#))
- 4. Setup additional optional inputs** – Two additional options exist to help constrain and provide user intervention in the horizon modeling process. The two options are to create borehole cross sections or a horizon conceptual model.
 1. [Including Borehole Cross Sections](#)
 2. [Horizon Conceptual Model](#)
- 5. Run the Horizons Wizard** – Select the **Horizons**→**3D Mesh** command in the *Borehole* or *TINs* menu. (See [Horizons Wizard](#))

Horizon → 3D Mesh Algorithm

When the **Horizon → 3D Mesh** command is executed the horizons specified on the borehole contacts or TIN nodes are converted to a set of scatter points with one dataset for each horizon. The scatter points are then used to interpolate a surface for each horizon. Starting with the lowest numbered horizon, the surface is extruded down to create a set of elements in a 3D mesh. The surface corresponding to the next horizon is then extruded down to fill in the space between that surface and the previous surface. This process is repeated for each surface. At each step, a set of elements are created for the current horizon and all previously defined elements are subtracted from that layer, resulting in an incremental buildup of the stratigraphy from the bottom to the top. The entire process results in a 3D mesh with each horizon layer represented by a material zone.

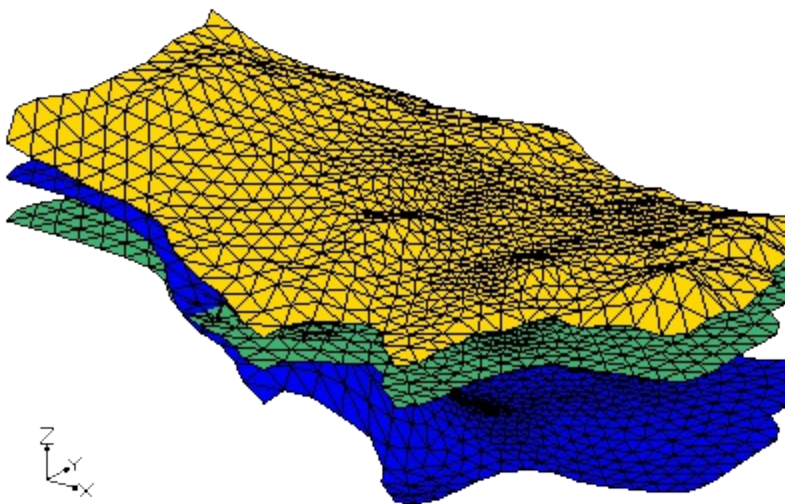

TINs used to create a 3D mesh

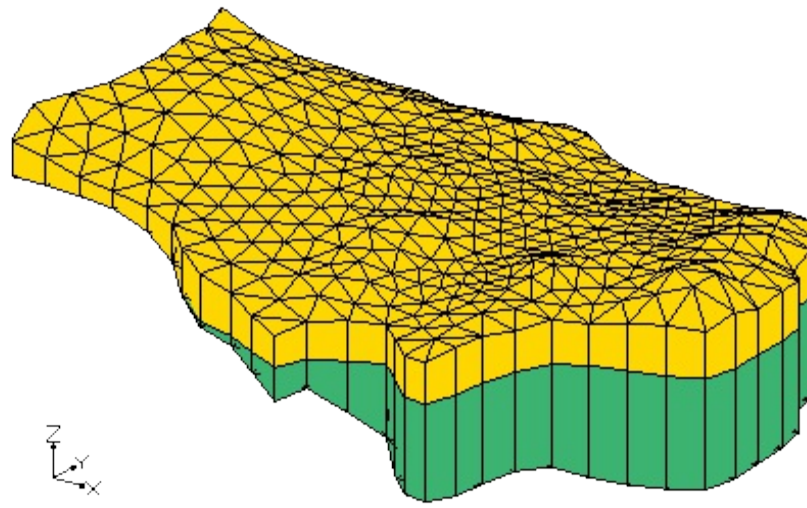

3D mesh created via the horizons method

Horizons to UGrid

The following steps illustrate how to use the Horizons method to create a UGrid.

- 1. Create/Import Inputs** – There are two main types of inputs for the horizons method:
 1. Boreholes – Boreholes can be created by importing borehole data by using the [File Import Wizard](#), importing sample data after boreholes already exist, or using the borehole tools to manually enter the boreholes. Once a borehole has been created it can be edited in the *Borehole Editor* or by using the borehole tools. Also an existing borehole can be copied. Boreholes can be locked to prevent them from being edited.
 2. TINs – TINs can be created 3 different ways in GMS: manually entering the vertex locations and triangulating, converting a different GMS data type to a TIN, and copying a currently existing TIN. (See [Creating TINs](#))
 3. [Raster Catalog](#) – A set of rasters defining the top of each horizon (available beginning in version 9.0).
- 2. Assign Horizon IDs** – The term “horizon” refers to the top of each stratigraphic unit that will be represented in a corresponding solid, HUF unit or material layer. Horizons are numbered consecutively in the order that the strata are “deposited” (from the bottom up). Horizons can be assigned to both boreholes and TINs. (See [Horizons](#))
- 3. Create Primary UGrid (2D)** – A 2D UGrid is needed to be used as a projection for the resulting 3D UGrid. A 2D UGrid needs to be created and selected as the primary UGrid. The 2D UGrid defines the boundary of the 3D UGrid.
- 4. Setup additional optional inputs** – Two additional options exist to help constrain and provide user intervention in the horizon modeling process. The two options are to create borehole cross sections or a horizon conceptual model.
 1. [Including Borehole Cross Sections](#)
 2. [Horizon Conceptual Model](#)
- 5. Run the Horizons Wizard** – Select the *Horizons* → *UGrid* command in the *Borehole* or *TINs* menu.

Horizon → UGrid Algorithm

When the **Horizon** → **UGrid** command is executed, the horizons specified on the borehole contacts or TIN nodes are converted to a set of scatter points with one dataset for each horizon. The scatter points are then used to interpolate a surface for each horizon. Starting

with the lowest numbered horizon, the surface is extruded down to create a set of cells in a UGrid. The surface corresponding to the next horizon is then extruded down to fill in the space between that surface and the previous surface. This process is repeated for each surface. At each step, a set of cells are created for the current horizon and all previously defined cells are subtracted from that layer, resulting in an incremental buildup of the stratigraphy from the bottom to the top. The entire process results in a UGrid with each horizon layer represented by a material zone.

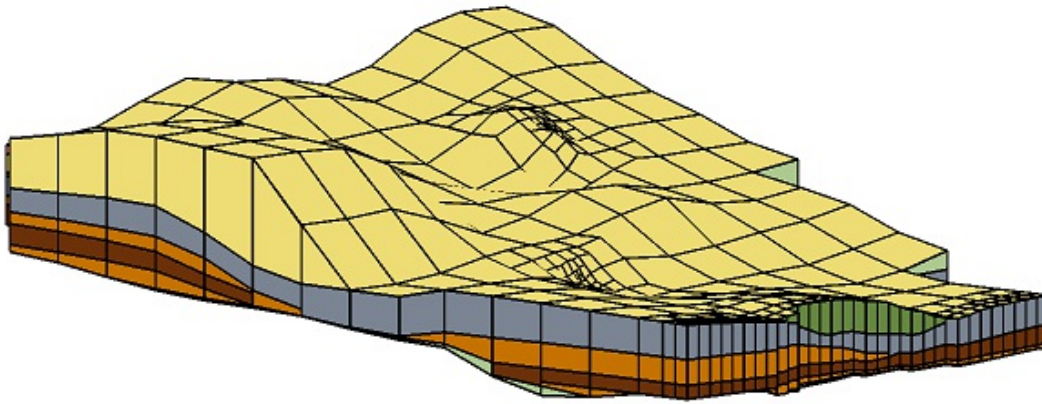

UGrid created via the horizons method

5.3. Solid Module

Solid Module

The Solid module of GMS is used to construct three-dimensional models of stratigraphy using solids. The module contains its own set [tools](#) and [menu commands](#) that can be used to modify solid data. [Properties](#) for solid data can be viewed and edited. The module also has its own [display options](#) for convenience in visualizing solid data.

Once such a model is created, [cross sections](#) can be cut anywhere on the model to create fence diagrams.

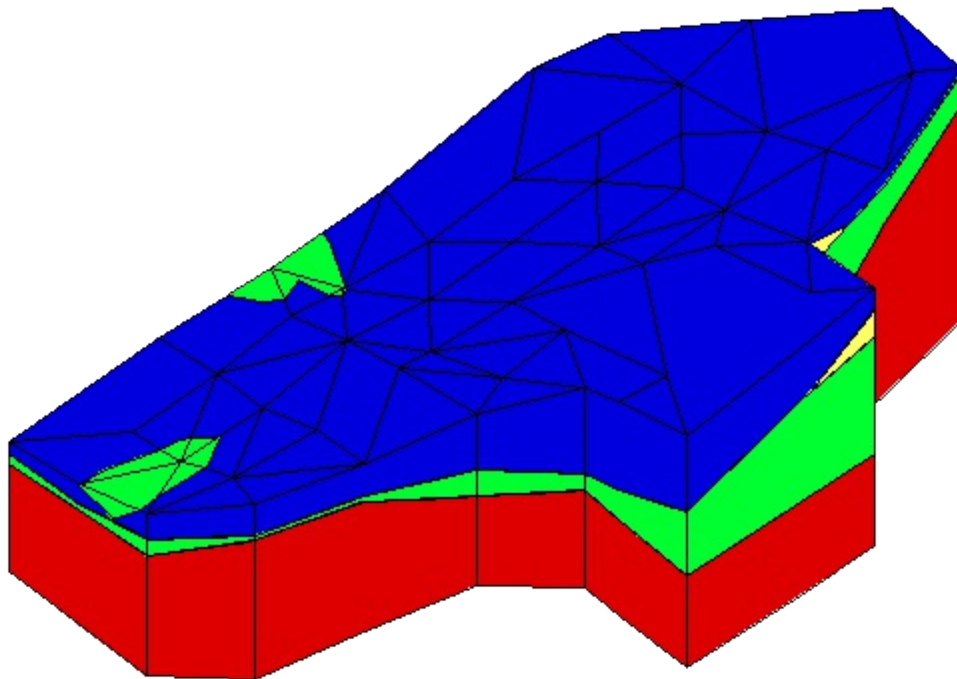

Example of a solid created in GMS

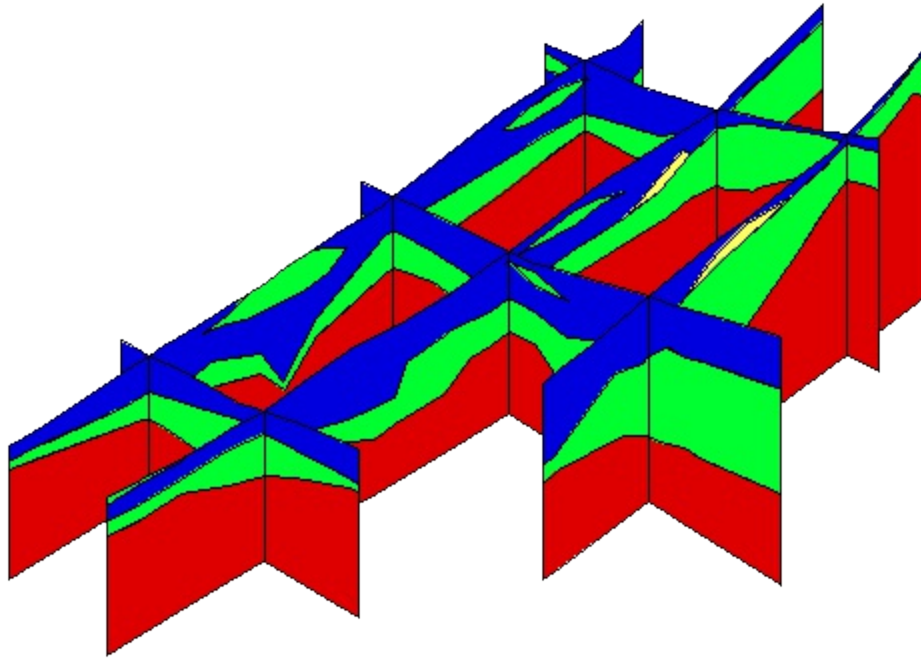

Example of fence diagrams created using solids

Solids are used for site characterization and visualization. Solids can also be used to define layer elevation data for MODFLOW models using the **Solids → MODFLOW command** or **Solids to HUF** and to define a layered 3D mesh using the **Solids → Layered Mesh**.

Solid Properties

The *Solid Properties* dialog allows the user to edit/view attributes of the selected solid. This dialog can be accessed by selecting a solid from the [Project Explorer](#), right-clicking to access the pop up menu, and selecting the **Properties** command. It can also be accessed by double-clicking on a solid in the graphics window, or by selecting a solid and then selecting the **Properties** command from the *Edit* menu.

The following items can be edited in the *Properties* dialog:

- *Solid Name* – Name of the solid.
- *Solid Material* – Material associated with the solid. The list will only show materials contained in the [Materials](#) dialog.
- *Begin Layer* – Beginning grid layer assigned to solid used with the [Solids](#)→**MODFLOW** procedure.
- *End Layer* – Ending grid layer assigned to solid used with the **Solids**→**MODFLOW** procedure.
- *Use top cell bias*– Option for using the top cell bias used with the **Solids**→**MODFLOW** procedure.
- *Top cell bias* – The percent to bias the thickness of the top cell with the **Solids**→**MODFLOW** procedure.
- *Target min. cell thickness* – Minimum cell thickness used with the **Solids**→**MODFLOW** procedure.

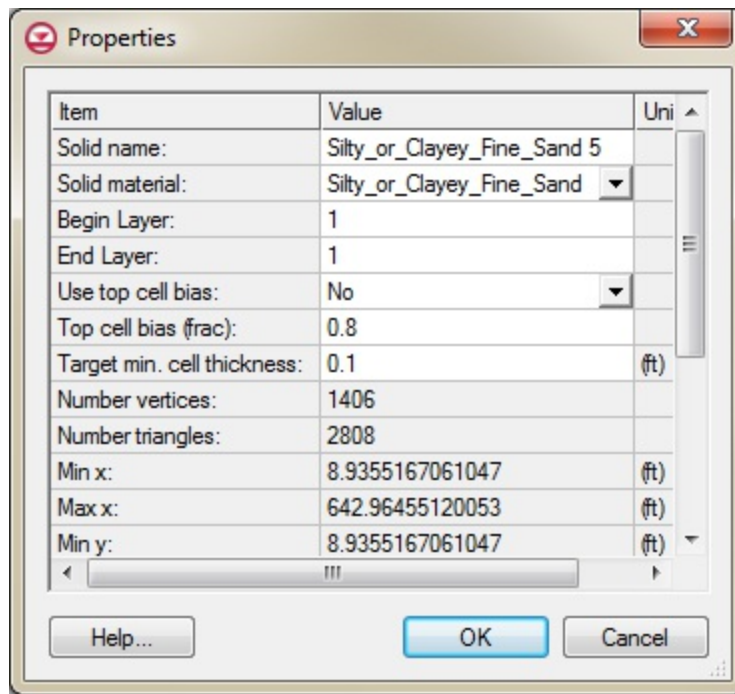

Example of the solids Properties dialog

The following items are displayed as information about the solid and cannot be edited in the dialog:

- *Number vertices* – Total number of vertices used in the solid.
- *Number triangles* – Total number of triangle elements used in the solid.
- *Max x* – The maximum distance away from the origin on the x-axis.
- *Min x* – The minimum distance away from the origin on the x-axis.
- *Max y* – The maximum distance away from the origin on the y-axis.
- *Min y* – The minimum distance away from the origin on the y-axis.
- *Max z* – The maximum distance away from the origin on the z-axis.
- *Min z* – The minimum distance away from the origin on the z-axis.
- *Centroid,x* – The point on the x-axis that is at the center of the solid.
- *Centroid,y* – The point on the y-axis that is at the center of the solid.
- *Centroid,z* – The point on the z-axis that is at the center of the solid.
- *Volume* – The calculated volume of the solid.

- *Projection* – The projection coordinates the solid is using.

Solid Primitives

To allow the addition of a trench, building, excavation, tunnel, etc. to a solid model, GMS provides the capability of generating several types of simple solid primitives. The solid primitives can be combined using [set operations](#) to model man made objects or other subsurface features which cannot be conveniently modeled by extruding TINs.

Cube

Simple cubes or, more precisely, hexahedrons whose faces are all parallel to the x, y, and z planes, can be created by selecting the **Cube** command from the *Solids* menu and specifying the center point of the cube and the x, y, and z dimensions.

Sphere

A sphere can be created by selecting the **Sphere** command from the *Solids* menu and inputting the radius of the sphere, the coordinates of the centroid of the sphere, and the number of subdivisions. The number of subdivisions determines the density of triangles used to approximate the sphere.

Cylinder

A cylinder can be created by selecting the **Cylinder** command from the *Solids* menu and inputting the coordinates of both ends of the cylinder, the radius of the cylinder, and the number of subdivisions in the cylinder. The number of subdivisions determines the density of triangles used to approximate the cylinder. The larger the number, the more accurate the representation will be, however the increased number of triangles will also cause display operations to be slower.

Prism



A prism can be created by first putting the image into plan view and then selecting the **Prism** command from the *Solids* menu. A prompt then asks to input a polygon. As with other polygons entered in GMS, the *Backspace* or *Delete* key can be used to delete the

last point entered, the *ESC* key can be used to abort the process, and double-clicking terminates point entry. A prompt then asks to enter a bottom elevation and a top elevation for the prism. The default values given for the top and bottom elevation represent elevations just above and just below all of the other solids. The polygon is then extruded from the top to the bottom elevation to create a solid object.

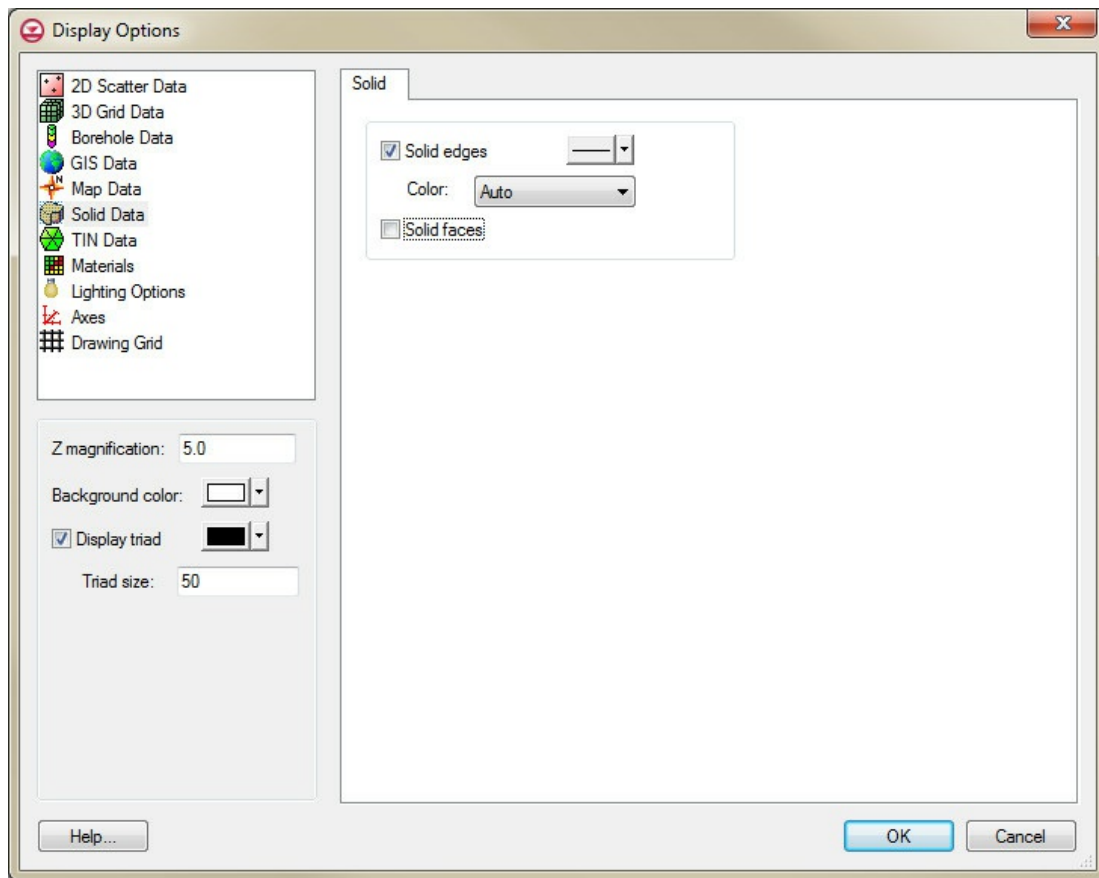
Solid Display Options



The Display Options dialog showing the Solids tab.

The properties of all solid data that GMS displays on the screen can be controlled through the *Solids* tab of the *Display Options* dialog. This dialog is opened by right-clicking on the Solid Data  entry in the [Project Explorer](#) and selecting the **Display Options** command. It can also be accessed from the *Display* menu or the **Display Options**  macro.

The following describes the display options available for the solids module.

- *Solid edges*

The Solid edges item is used to display the edges of the solid. The solids are either drawn using the default cell color or the color of the material associated with each solid.

The color of the solid edges can be adjusted according to the following options:





1. *Auto* – draws the material color if faces are not displayed. Uses black or white if the faces are displayed
2. *Specified* – used the color specified next to the solid edges
3. *Material* – displays the material color of the solid

- *Solid faces*

The Solid faces item causes the faces of the solid to be drawn as filled polygons.

Solid Module Tool Palette

The following tools are available in the dynamic portion of the tool palette whenever the Solid module is activated. Only one tool is active at any given time. The action that takes place when clicking in the [Graphics Window](#) depends on the current tool. The following table describes the tool in the solid tool palette.

Tool	Tool Name	Description
	Select Solid	The <i>Select Solid</i> tool is used to select solids for deletion or for set operations . When this tool is active, a solid icon appears at the centroid of each solid. A solid is selected by selecting the icon. When a different tool is selected, the icons disappear.
	Select Face	The Select Face tool is used to select the faces of a solid.
	Select Cross Section	Once a set of cross sections has been created, they can be selected using the Select Cross Section tool. Selected cross sections can be deleted or made visible or invisible using the Hide and Show commands. When this tool is active, a cross sections icon appears on each cross section. A cross section is selected by selecting the icon. When a different tool is selected, the icons disappear. When there are several cross sections, it is often easier to differentiate cross section icons in plan view (assuming the cross sections were created in plan view). As a general rule, the icons are placed in the center of the first line segment used to cut the cross section.
	Create Cross Section'	Cross sections can be created from the solids that are currently being displayed using the Create Cross Section tool. Cross sections are formed when entering a polyline. A polyline is entered by clicking on several points and double-clicking on the final point when the line is finished. The <i>Delete</i> or <i>Backspace</i> key may be used to remove a point from the polyline, and the <i>ESC</i> key can be used to abort the process. A cross section or fence diagram is then computed by cutting perpendicular to the current viewing orientation through the currently visible solids (a solid can purposefully be left out of a cross section by hiding it before making the cross section). A section or "panel" in the fence diagram is created for each line segment in the polyline. While most cross sections are created with the solids in plan view, any viewing orientation can be specified. When cross sections are created, the materials associated with the solids are inherited by cross sections. Cross sections can be saved to a file if desired.

Solids to Layered Mesh

The **Solids** → **Layered Mesh** command in the *Solids* menu can be used to quickly build a 3D finite element mesh that matches the stratigraphy defined by a set of solids. This option is similar to the *Boundary Matching* option of the **Solids** → **MODFLOW** command except it results in a layered 3D finite element mesh that honors the horizontal boundaries of the stratigraphic layers defined by a set of solids. The steps involved in using the **Solids** → **Layered Mesh** command are as follows:

1. Create a 2D Projection Mesh

The first step is to create a 2D projection mesh. This mesh represents a plan view of the 3D mesh. Each triangle in the 2D mesh will result in a column of 3D wedge elements and each quadrilateral in the [2D mesh](#) will result in a column of 3D hexahedral elements. The 2D mesh can be refined around well locations if desired. This mesh is typically created using the [Map module](#) as part of the [FEMWATER](#) conceptual model.

2. Create the Solids

The next step is to create the solids defining the stratigraphy. The boundary of the solids should be slightly larger than the 2D projection mesh.

3. Assign layer ranges to the Solids

As is the case with the *Solids* → *MODFLOW Boundary Matching* option, a layer range should be assigned to each of the solids. There is one significant difference in assigning layer ranges with the **Solids** → **Layered Mesh** command is that every layer in the 3D mesh must be present in the solids. There cannot be "inactive" mesh elements similar to "inactive" grid cells.

4. Solids → Layered Mesh Command

Unlike the *Solids → MODFLOW Boundary Matching* option, it is not necessary to create a [3D mesh](#) before selecting the **Solids → Layered Mesh** command. The 3D mesh is automatically generated. Each element in the 2D projection mesh is extruded into a vertical column of cells and the solids are used to assign the elevations to the nodes. The material ids are assigned to the 3D elements by finding the solid that encompasses the centroid of each 3D element assigning the material id of that solid to the element.

Sample Mesh

A sample mesh created with the *Solids → Layered Mesh* option is shown below. Note that the solids boundaries are preserved at the tops and bottoms of the solids but the transition along the edges of the solids can be irregular.

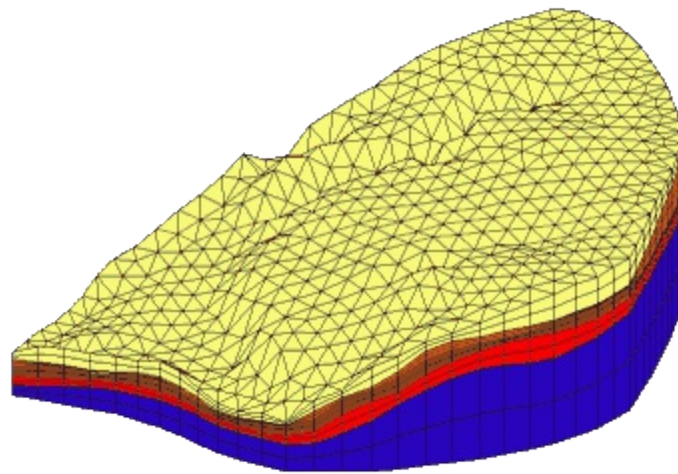

*Sample mesh created using the **Solids → Layered Mesh** command*

Related Topics

- [Solid Module](#)

Solids to HUF

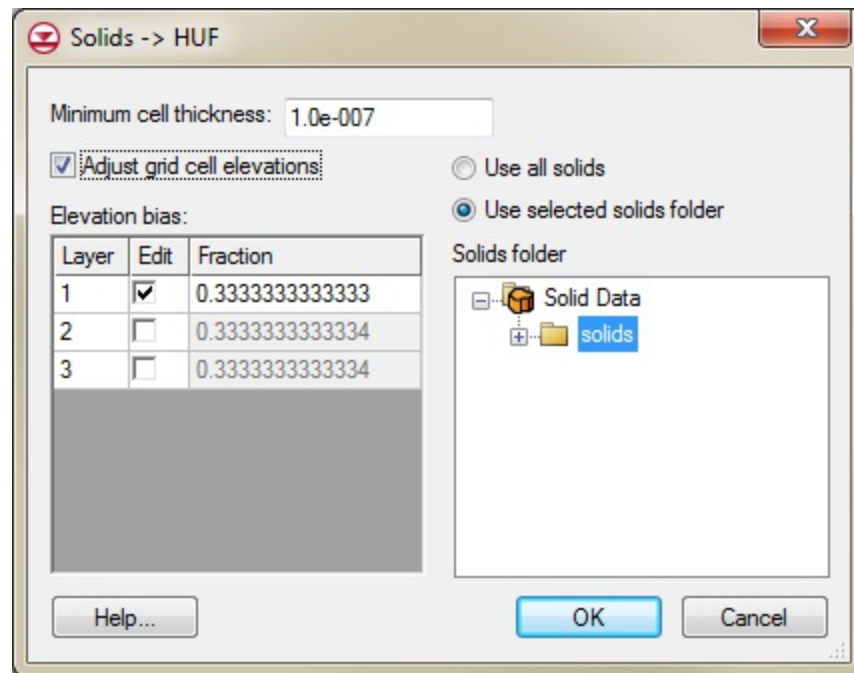

The Solids → HUF dialog

The **Solids** → **HUF** command in the *Solids* menu of the [Solid Module](#) can be used to generate the HUF package input data from the solids currently in the project.

This command brings up the *Solids* → *HUF* dialog. By turning on the *Adjust grid cell elevations* option, the 3D grid cell elevations can be adjusted. The *Minimum cell thickness* edit field allows specifying a minimum cell thickness. When the elevations are adjusted, if a cell has a thickness less than the minimum the bottom cell in that column will be inactivated and the cell elevations will be recalculated. The *Fraction spreadsheet* contains a row for each layer in the 3D grid. By default, each layer is assigned an equal fraction. Edit the fraction assigned to any layer by checking the *Edit* option and changing the fraction. Any layers that don't have the *Edit* option checked are evenly distributed so that the sum of the all the fractions is one.

When selecting **OK** from the *Solids* → *HUF* dialog the solids are intersected by the grid. The intersections of the solids are then converted into HUF hydrogeologic unit top and thickness arrays.

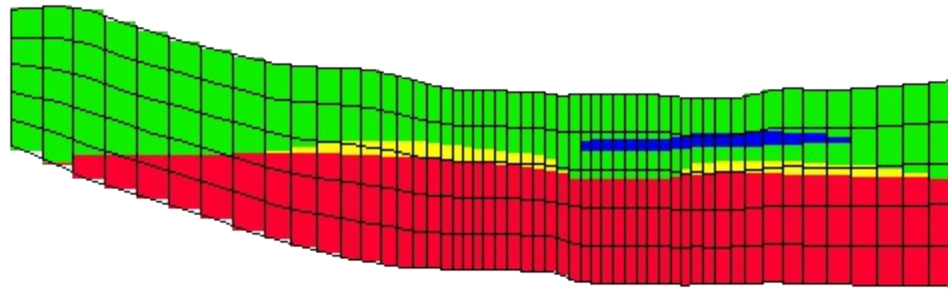

Example of HUF data created from solids

Solids to MODFLOW Command

The **Solids** → **MODFLOW** command represents a powerful tool for modeling complex stratigraphy in a completely grid-independent fashion. As part of the overall conceptual model building process, the stratigraphy at a site is modeled as a set of solids. The solids are built using tools in the [Borehole](#), [TIN](#), and [Solids](#) modules. These solids can represent a wide variety of complex stratigraphic relationships. Then assign hydraulic conductivity (K_h and K_v) and storage coefficients to the solids as material properties and a multi-layer grid is constructed where the boundary of the grid occupies the same region of the solids in plan view. The **Solids** → **MODFLOW** command can then be used to automatically define the elevation arrays in [MODFLOW](#). If the grid is refined or edited in any way, this command can be selected again to rebuild the arrays in seconds with no further user intervention. Together with the feature objects in the Map module, a set of solids can be used to build a completely grid-independent conceptual model regardless of the complexity of the site.

Following is the set of steps required to use the **Solids** → **MODFLOW** command:

1. Building the Solids
2. Material Properties
3. Creating the Grid
4. When using Boundary matching, match layers to solids
5. Execute **Solids** → **MODFLOW**

Building the Solids

Before executing the **Solids** → **MODFLOW** command, a set of solids should be constructed that match the site stratigraphy. These solids are typically constructed using the [horizons](#) approach. When building these solids, it is best to build the primary TIN with a larger outer polygon boundary than the boundary that is used to define the [MODFLOW](#) conceptual model. This ensures that the stratigraphy will encompass all of the grid.

Material Properties

The next step is to create a set of material properties for the solids using the **Material** command in the *Edit* menu.

Creating the Grid

Once the solids are created and the layer assignments are made, the next step is to create a grid. The grid boundary in the xy plane (plan view) should either match the boundary of the solids or encompass the solids. The grid can be refined around wells if desired. The number of layers in the grid should be compatible with the layer assignments made to the solids. When the grid is first created, the z elevations can be ignored since they will be inherited from the solids. A sample grid is shown below.

After the grid is created, the cells outside the model domain should be inactivated using the **Activate Cells in Coverage** command in *Feature Objects* menu in the Map module.

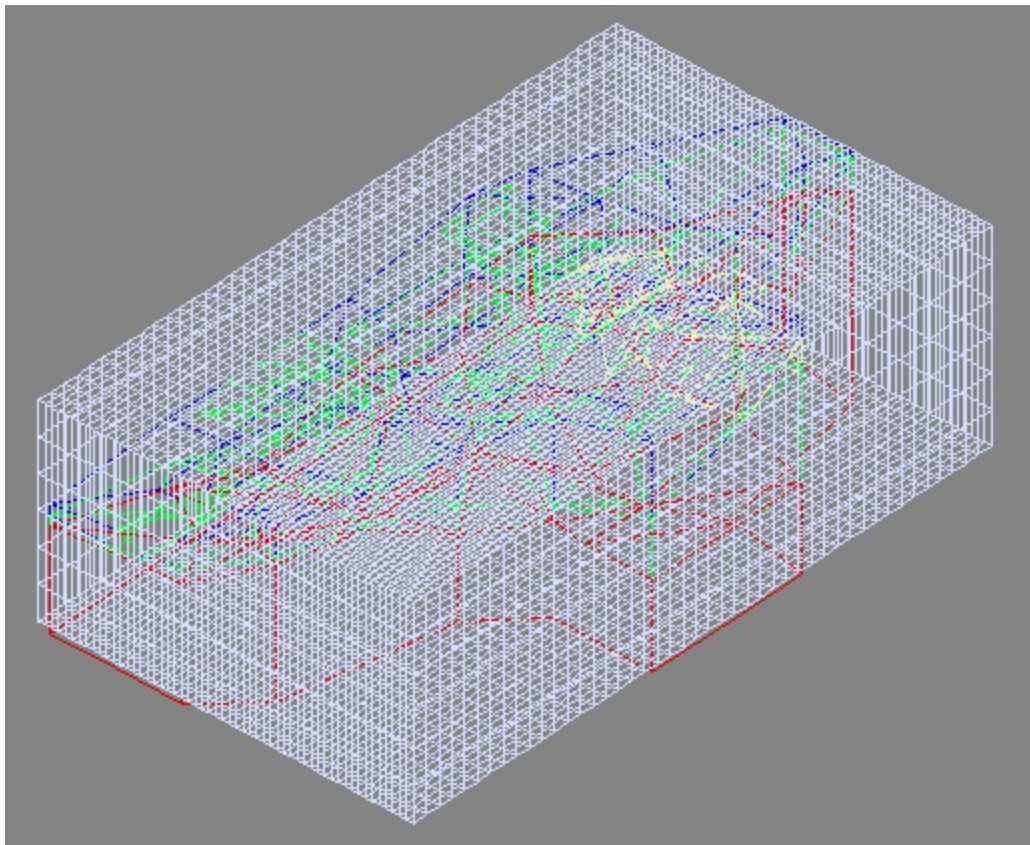

Sample grid created in GMS

Solids → MODFLOW Options

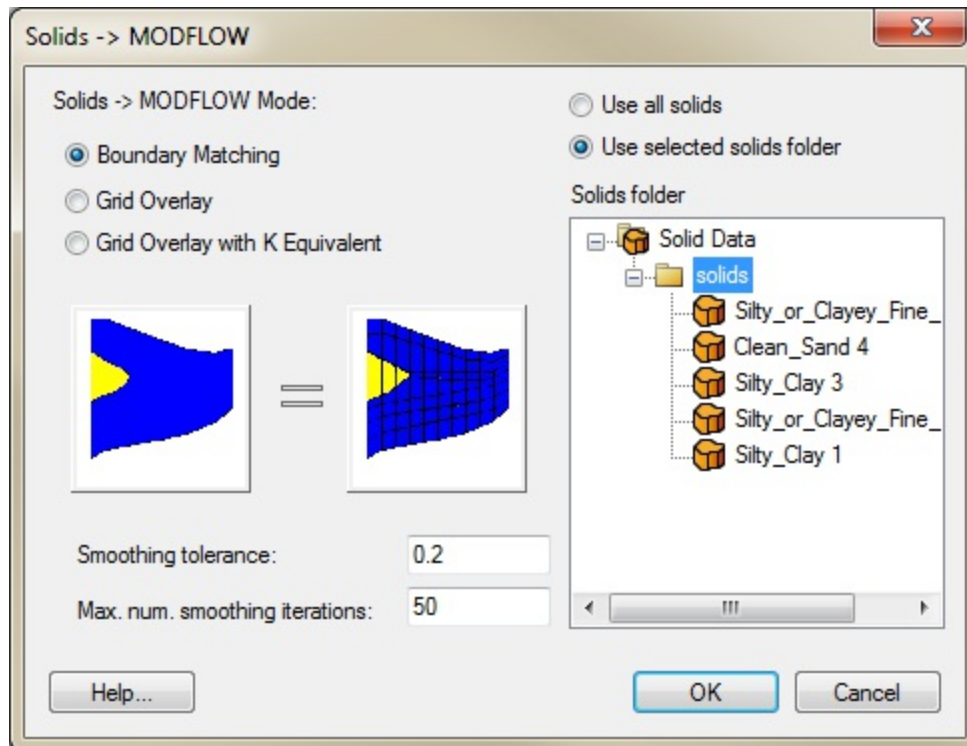

The Solids → MODFLOW dialog

The **Solids** → **MODFLOW** command brings up a dialog listing the three basic options associated with the **Solids** → **MODFLOW** command. Each option utilizes a different approach for converting the solid stratigraphy to the MODFLOW BCF input arrays. The three options are:

1. [Boundary Matching](#)
2. [Grid Overlay](#)
3. [Grid Overlay with Keq](#)

Boundary Matching

One of the three basic options associated with the **Solids** → **MODFLOW** command is the *Boundary Matching* option. The goal of the boundary matching algorithm is to compute a set of elevation arrays that honor the boundaries between the stratigraphic units as closely

as possible.

Solids and Layer Ranges

Next a layer range must be assigned to each solid. The layer range represents the consecutive sequence of layer numbers in the MODFLOW grid that are to coincide with the solid model. A sample set of layer range assignments is shown in the figure below (a). The example in the figure below is a case where each solid is continuous through the model domain and there are no pinchouts. Each of the solids is given a layer range defined by a beginning and ending grid layer number. The resulting MODFLOW grid is shown in the figure below (b).

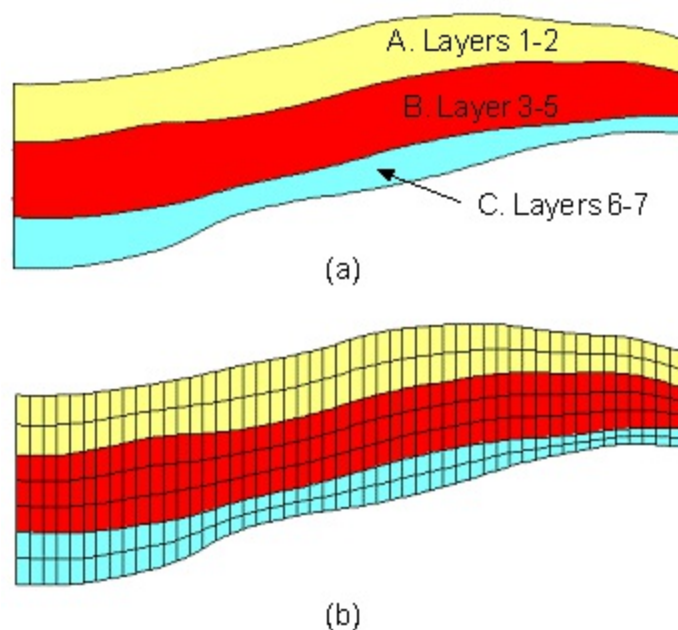

(a) A Set of Simple Solids with Grid Layer Assignments (b) The MODFLOW Grid Resulting From the Layer Assignments

A more complex case with pinchouts is illustrated in the next figure (a). Solid A is given the layer range 1–4, and the enclosed pinchout (solid B) is given the layer range 2–2. The set of grid layers within the defined range that are actually overlapped by the model may change from location to location. The layer range represents the set of grid layers potentially overlapped by the solid anywhere in the model domain. For example, on the left side of the problem shown in the figure below (a), solid A covers grid layers 1, 2, 3 and 4. On the right side of the model, solid A is associated with grid layers 1, 3 and 4 since the

enclosed solid (solid B) is associated with layer 2. Likewise, Solid C is associated with grid layers 5 and 6 on the left side of the model but only with layer 6 on the right side of the model where solid D is associated with layer 5. The resulting MODFLOW grid is shown in the figure below (b).

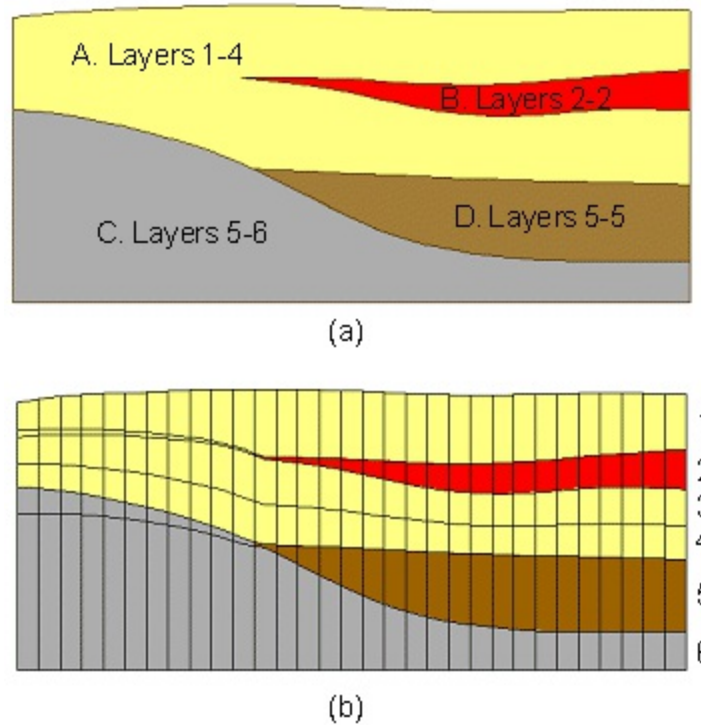

(a) Grid Layer Assignments for a Set of Solids with Pinchouts (b) The MODFLOW Grid Resulting From the Layer Assignments

When assigning layer ranges to solids, care must be taken to define associations that are topologically sound. For example, since solid B in the figure above (a) is enclosed by solid A, solid B could not be assigned a layer range that is outside the layer range of solid A.

Layer ranges are assigned using the [Solids Properties](#) dialog.

Solids → MODFLOW Command

The final step is to select the **Solids → MODFLOW** command in the *Solids* menu. The layer elevations and material properties for the 3D grid will then be automatically assigned from the solids as shown below.

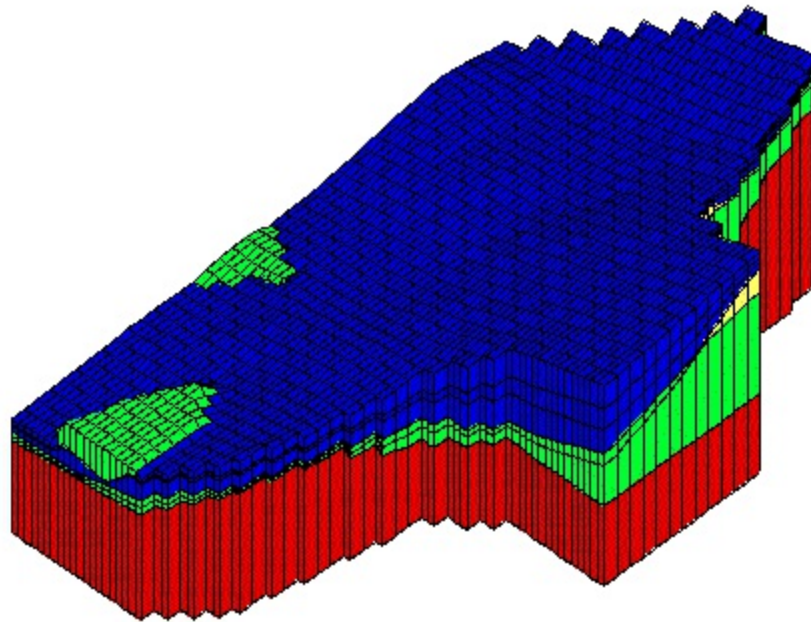

*Grid after using the **Solids**→**MODFLOW** command*

The following images represent cross-sections at selected locations of the grid shown above. Notice that the grid elevations precisely match the stratigraphic boundaries defined by the solids while maintaining the continuous layers required by **MODFLOW**.

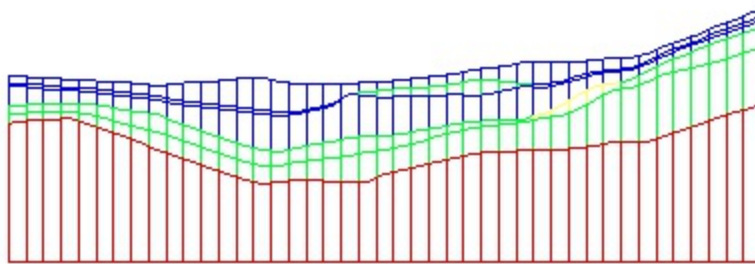

Sample cross-section

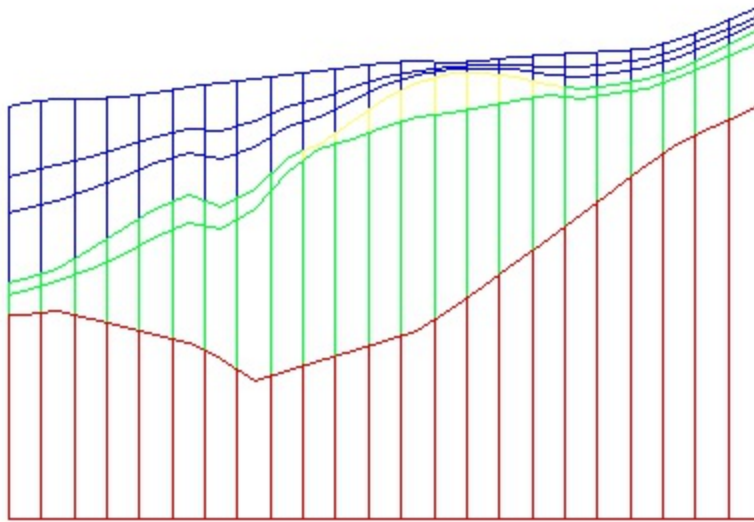

Smoothing Tolerance

When the **Solids** → **MODFLOW** command is executed with the *Boundary Matching* option, it is common to have seams that occupy only a portion of a layer as shown in the above cross sections. The top and bottom elevations for cells adjacent to these seams must be adjusted by GMS using a "smoothing" process to ensure that there are not drastic cell size differences in the horizontal direction from one cell to the next. The smoothing is accomplished by iteratively changing the elevation of selected cells until the cell elevations change less than the *Smoothing Tolerance* specified in the *Solids* → *MODFLOW Options* dialog.

Minimum Thickness

This option enables avoiding extremely thin layers at edges of pinchouts and represents the minimum thickness of grid cells created from the solids. Solids with thickness less than this amount are ignored and the surrounding material is used instead. This property is assigned in the [solids Properties](#) dialog. The figure below demonstrates the application of this property.

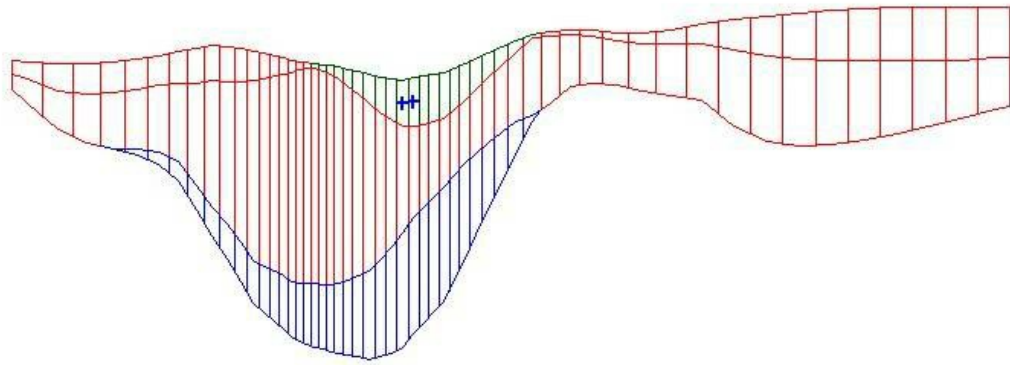

Small minimum thickness

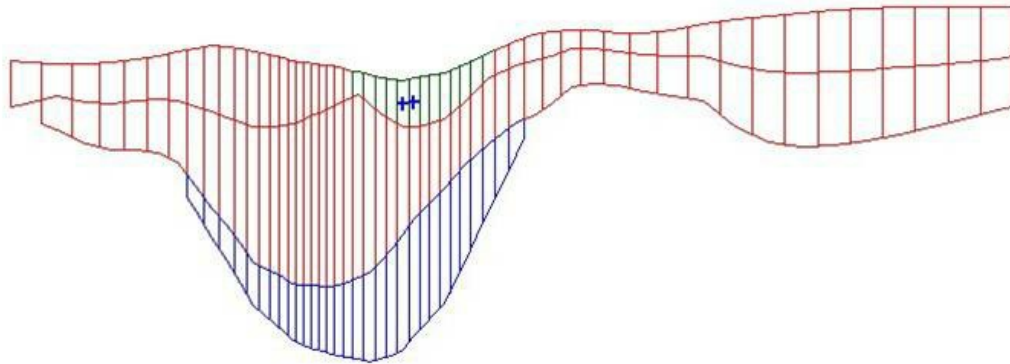

Larger minimum thickness

Top Cell Bias

The top cell bias is the percentage of the thickness which is assigned to the top layer of the MODFLOW grid create from the solids. The thickness of the top layer increases as the top cell bias increases. A large top cell bias can be used to prevent top-layer cells from going dry. This property is assigned in the [solids properties](#) dialog.

Grid Overlay

The **Grid Overlay** option is one of the three basic options for the **Solids** → **MODFLOW** command. The *Grid Overlay* option is similar to the [Boundary Matching](#) option. While the *Boundary Matching* option precisely matches stratigraphic boundaries, it does have some

drawbacks. It can result in very thin layers at certain locations in the grid such as transition points at the boundary of a solid that pinches out to a sharp edge. In some cases, these thin layers can cause stability problems with MODFLOW or with a subsequent transport analysis. For such cases, the *Grid Overlay* method or the [Grid Overlay with Keq](#) method may provide superior results.

With the *Grid Overlay* option, no layer range assignments are necessary. Once the solids and grid are created, the **Solids** → **MODFLOW** command can be immediately selected. For each vertical column of cells, GMS intersects a vertical ray through the cell center and finds the highest and lowest intersection, i.e. the top and bottom of the entire set of solids. These elevations become the top and bottom elevation of the entire grid. The elevations of any intermediate layer boundaries are then linearly interpolated between these two extremes. The material properties are then assigned by computing the xyz coordinates of the center of each cell and determining which solid encloses the cell center. The material properties from that solid are then assigned to the cell. The result is shown in the following figure (compare this to the example shown in the [Boundary Matching](#) topic). Note that the boundaries of the solids are not preserved as accurately as they are with the boundary matching algorithm. However, the cell sizes are much more consistent and extremely thin cells are avoided.

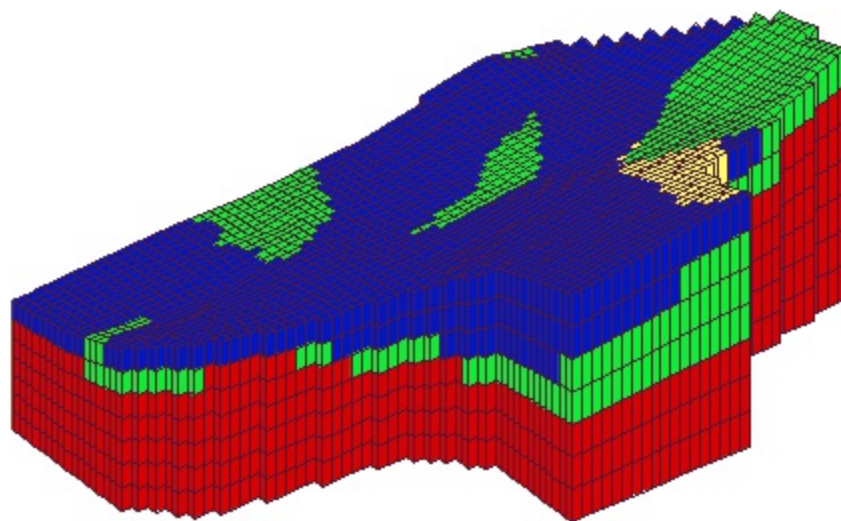

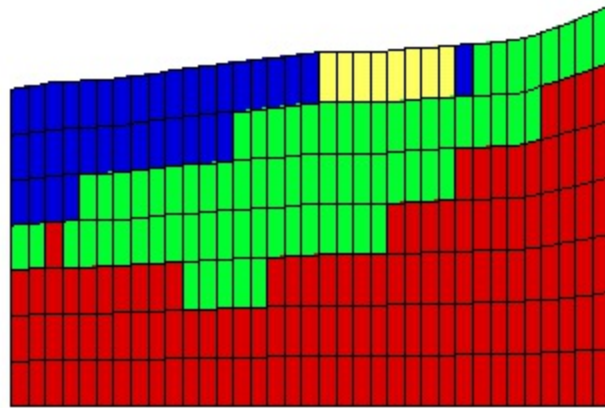
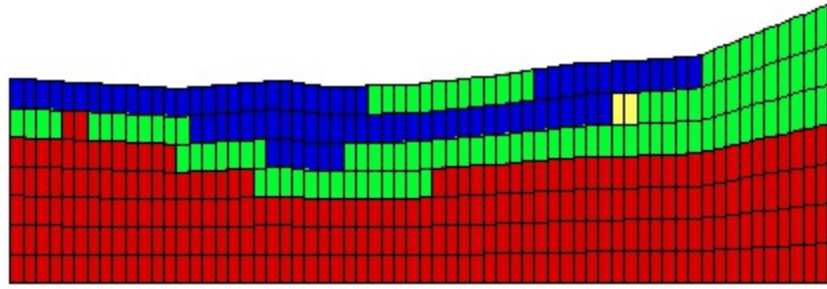

Minimum Thickness

In some cases, the set of solids used with the *Grid Overlay* method may have thin sections where the vertical thickness of the entire set of solids becomes extremely small. In such cases, the resulting grid cells become very thin as they are "squeezed" in this thin region. The cell thickness in these regions can be controlled using the *Minimum Thickness* value in the *Solids Attributes* dialog. When each vertical column of cells is processed, the height of the cells in the column is compared to the minimum thickness. If the cell height is less than the minimum, one or more cells at the bottom of the grid are inactivated until the minimum thickness is satisfied.

Grid Overlay with Keq

The *Grid Overlay with K Equivalent* option is one of the three basic options for the **Solids**

→ **MODFLOW** command. This option is very similar to the *Grid Overlay* option.

One of the problems with the *Grid Overlay* option is that if there is a relatively thin layer in the solids and the layer does not happen to encompass any cell centers or it encompasses few cell centers, the layer will be under-represented in the MODFLOW grid. This becomes particularly important if the layer is meant to represent a low permeability layer. For such cases, the *Grid Overlay with K Equivalent* option may give superior results. The *Grid Overlay with K Equivalent* method is identical to the *Grid Overlay* method in terms of how the elevations of the grid cells are defined. The two methods differ in how the material properties are assigned. Rather than simply assigning materials based on which solid encompasses the cell centers, the Keq method attempts to compute a custom K_h and K_v value for each cell. When assigning the material properties to a cell, GMS computes the length of each solid in the cell (from a vertical line at the cell center that intersects the solids) and computes an equivalent K_h , K_v , and storage coefficient for the cell that takes each of the solids in the cell into account. Thus, the effect of a thin seam in a cell would be included in the K_h and K_v values for the cell.

The equivalent K_h is computed as follows:

$$K_h = \frac{\sum K_{hi} M_i}{\sum M_i}$$

where K_{hi} is the K_h of a solid and M_i is the length of the same solid intersected at the cell center.

The equivalent K_v is computed as follows:

$$K_v = \frac{\sum M_i}{\sum \frac{M_i}{K_{vi}}}$$

where K_{vi} is the K_v of a solid and M_i is the length of the same solid intersected at the cell center.

A horizontal cross-section through a sample grid defined via the *Grid Overlay with Keq* method is shown below. The colors represent the resulting K_h values. Note how the K values transition at the boundaries of the solids.

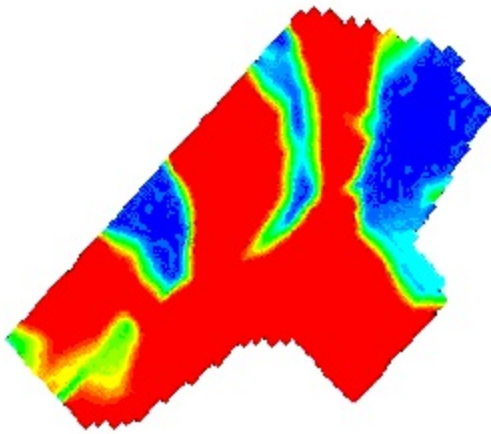

Parameter Estimation

Caution should be taken when using the *Grid Overlay with Keq* method when performing [automated parameter estimation](#). The "key value" approach to defining parameter zones for PEST requires that the values assigned to the zones be unique within each zone. With the *Boundary Matching* and *Grid Overlay* methods, the key values could be assigned to the solids and the values would be properly inherited by the grid cells. With the *Grid Overlay with Keq* method, the parameter values are "blurred" at the edges of the solids and the key values assigned to the solids would be lost.

Solid Commands

When the Solids module is active, the *Solids* menu become available. The *Solids* menu has one submenu; the *Advanced* submenu. Below is a list of commands in the *Solids* menu:

Cube...

Creates a new 3D cube object.

Sphere...

Creates a new 3D sphere object.

Cylinder...

Creates a new 3D cylinder object.

Prism...

Creates a new 3D prism object.

Group Faces

Adds selected solid faces to a new group. Thereafter selecting any face in the group will select all faces in the group. Useful for assigning properties to solid faces for ADH.

Ungroup Faces

Eliminates the selected face group so that faces in the group can be selected individually.

Solids → MODFLOW...

Opens the *Solids* → *MODFLOW* dialog allowing mapping solids to MODFLOW layer elevations.

Solids → HUF...

Opens the *Solids* → *HUF* dialog allowing mapping solids to MODFLOW HUF units.

Zoom To Extents

Frames the Graphics Window around the selected objects.

Advanced>

Solids → Layered Mesh...

Using a 2D mesh for to project from, builds a 3D mesh matching mesh elements to the solid geometry.

Set Operations...

Deprecated. Union, difference, and intersection operations on solids.

Related Topics

- [Boreholes](#)

5.4. 2D Mesh Module

2D Mesh Module

The 2D Mesh module is used to construct two-dimensional finite element meshes. The mesh consists of nodes that are grouped together to form elements. Numerous [tools](#) are provided for [automated mesh generation](#) and [mesh editing](#). 2D meshes are used for [SEEP2D](#) modeling and to aid in the construction of 3D meshes.

The figures below show an example of a SEEP2D model and a [3D mesh](#) created using the 2D Mesh module.

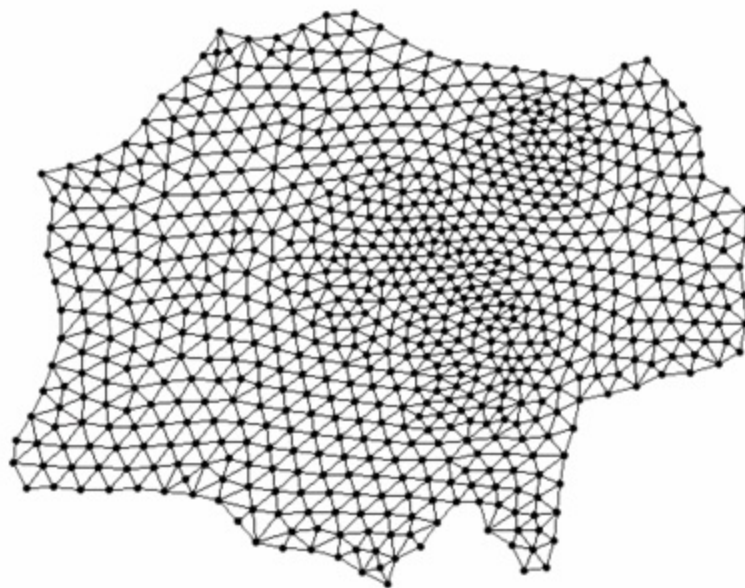

2D Projection Mesh

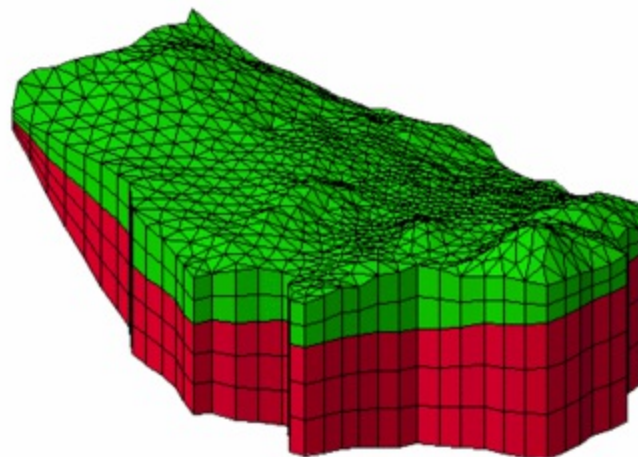

Extruded 3D Mesh

3D Mesh created by extruding a 2D mesh

Sample Confined Seepage Problem

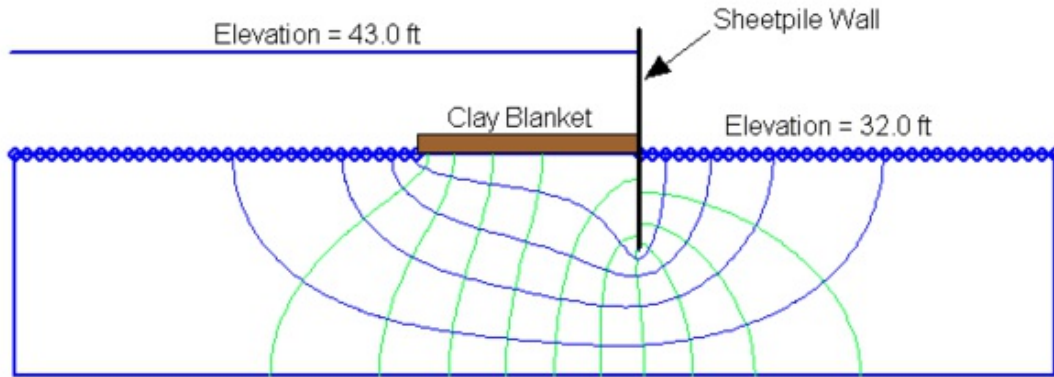

Sample SEEP2D problem

The module contains its own [settings](#) and [display options](#) including options to for contour and vector display. Currently, GMS only allows one 2D mesh to be included in a project.

Datasets in a mesh store scalar or vector values at each node. Individual datasets can be duplicated or exported.

2D mesh data can be exported from GMS by right-clicking on the 2D mesh and selecting the **Export** command. The entire mesh can be exported as a Text GMS 2D Mesh File (*.2dm), FEFLOW ASCII FEM Format (*.fem), Polygon Shapefile (*.shp), or Point Shapefile (*.shp).

The 2D Mesh module can be added to a [paid edition](#) of GMS.

Mesh Element Types

Elements are used to describe the area to be modeled. Elements are formed by joining nodes. The element types supported vary from model to model. Element types include:

- Three-node linear triangle
- Six-node quadratic triangle
- Eight-node "serendipity" quadrilateral

- Nine-node "Lagrangian" quadrilateral

Creating a 2D Mesh

2D Meshes can be created 3 different ways in GMS: using an automatic meshing technique, manually entering the node locations and triangulating, or converting a different GMS data type to a 2D Mesh.

Using an Automatic Meshing Technique

[Map → 2D Mesh](#) is the preferred method for mesh generation in GMS.

Manually Creating a 2D Mesh

In order to create a 2D Mesh in GMS there must be a set of 2D Mesh nodes. Elements can be created by using one of the **Create Element** tools in the [2D Mesh Tool Palette](#) and then selecting the mesh nodes to create elements. A 2D Mesh can also be created by [triangulating](#) the nodes. The triangulation algorithm assumes that each of the vertices being triangulated is unique in the xy plane, i.e., no two points have the same xy location.

Duplicate points can be removed by selecting **Find Duplicates** command from the *Mesh* menu. A prompt will ask to input a tolerance to be used when checking for duplicate nodes. Two nodes are considered to be duplicates if the XY distance between them is less than or equal to the specified tolerance. Also specify whether the duplicate nodes are to be deleted or simply displayed in red.

A 2D Mesh can be created manually from the following steps:

1. Select the **Create Nodes** tool from the [2D Mesh Tool Palette](#).
2. Create the Nodes by clicking inside the Graphics Window at the xy coordinates where the vertex is to be located. (To change the node location see [Editing 2D Meshes](#))
3. Select the **Create Linear Triangle Element** tool from the [2D Mesh Tool Palette](#).
4. Select the [Triangulate](#) command from the *Mesh* menu.

Creating a 2D Mesh from GMS Data

TINs, 2D grids, 2D scatter points, and 3D meshes can all be converted to a 2D Mesh. This is accomplished by using the following commands:

TIN → 2D Mesh

One triangular element is created for each triangle in the TIN. Any datasets associated with the TIN are copied to the new mesh.

2D Grid → 2D Mesh

A four node quadrilateral element is created from each cell in the grid.

2D Scatter Points → 2D Mesh Nodes

Creates a set of 2D finite element nodes from the points in the active scatter point set. Requires triangulating the nodes to create the 2D mesh.

3D Mesh → 2D Mesh

Creates a 2D mesh from the upward facing elements of the 3D mesh. Datasets associated with the 3D mesh are not transferred to the 2D mesh.

Editing 2D Meshes

Editing Nodes

Insert Node

New nodes in a 2D mesh are created by selecting the **Create Nodes** tool from the [2D Mesh Tool Palette](#) and clicking where the new node is to be located. The default parameters governing the creation of new nodes can be specified using the **2D Mesh Settings** command in the *Mesh* menu. This brings up the *Node Options* dialog.

Delete Node

A set of selected nodes can be deleted by hitting the *Delete* key or selecting the **Delete** command from the *Edit* menu. If the deleted node is connected to one or more elements, the action taken when the node is deleted depends on the status of the options in the *2D Mesh Settings* dialog.

If the *Retriangulate voids when deleting* option is turned on, the void created when a node and the elements surrounding the node are deleted is re-triangulated or filled in with triangles. This feature makes it possible to selectively "unrefine" a region of the mesh or reduce the density of the nodes in a region of the mesh without having to completely recreate all of the elements in the region.

If the *Retriangulate voids when deleting* item in the *Node Options* dialog is not set, the selected node and the elements surrounding the node are simply deleted and the resulting void is not filled in with triangles.

If the **Confirm Deletions** option in the *Edit* menu is active, GMS will ask to confirm each deletion. This feature is helpful in preventing accidental deletions. The *Confirm Deletions* item is toggled by selecting it from the menu.

Move Node

The coordinates of a 2D Mesh node can be edited by selecting the mesh node and entering

the new coordinates in the edit boxes in the *Edit Window*. It is also possible to drag an existing node to a new location by clicking on the node and moving the mouse with the button held down until the node is in the desired position.

If the *Snap to Grid* option in the *Drawing Grid Options* dialog is set, the node will move in increments corresponding to the drawing grid. If the node being dragged is connected to one or more elements, GMS will not allow the node to be dragged to a position where one of the surrounding elements would become ill-formed.

Since it is possible to accidentally drag points, nodes can be "locked" to prevent them from being dragged by selecting the **Lock All Nodes** item from the *Mesh* menu. The nodes can be unlocked by unselecting **Lock All Nodes** from the *Mesh* menu.

Editing Elements

Convert Between Linear and Quadratic

Linear elements (three node triangles and four node quadrilaterals) can be converted to quadratic elements (six node triangles and eight node quadrilaterals) and vice versa by selecting the **Convert Elements** item from the *Mesh* menu.

If there are both linear and quadratic elements in the mesh (as may be the case with a disjoint mesh), a prompt will ask to specify the type of conversion desired; linear to quadratic or quadratic to linear.

Merging Triangles

The *triangulate* operation creates a mesh composed entirely of triangles. In some cases it is desirable to have the mesh composed primarily of quadrilateral elements. Quadrilateral elements result in a more concise mesh which leads to faster solutions, and quadrilateral elements are often more stable numerically. To address this need, two options are provided for converting triangular elements to quadrilateral elements: The Merge Triangles command, the Merge/Split Tool.

The Merge Triangles Command

The **Merge Triangles** command in the *Modify Mesh* menu can be used to automatically

merge pairs of adjacent triangular elements into quadrilateral elements. Upon selecting the **Merge Triangles** command, a prompt will ask to input a minimum interior angle. This angle should be between 0° and 90° . If no elements are selected, all of the triangular elements in the mesh are then processed. If some elements have been selected, only the selected elements are processed. The conversion process works as follows:

1. The set of elements to be processed is traversed one element at a time. Each triangular element that is found is compared with each of its three adjacent elements. If the adjacent element is a triangle, the trapezoid formed by the triangle and the adjacent triangle is checked.
2. Each of the four interior angles of the trapezoid is computed and compared to a minimum interior angle. If all of the angles are greater than the user-specified minimum interior angle, then the two triangles are merged into a single quadrilateral element.

This process is repeated for all of the elements. The merging scheme will not always result in a mesh composed entirely of quadrilateral elements. Some triangular elements are often necessary in highly irregular meshes to provide transitions from one region to the next.

The Merge/Split Tool

The other option for merging triangles involves the use of the **Merge/Split** tool in the [2D Mesh Tool Palette](#). This tool can be used to manually merge triangles one pair at a time rather than using the automatic scheme described above.

The manual method is also useful to edit or override the results of the automatic merging scheme in selected areas. The **Merge/Split** tool can also be used to undo a merge. A quadrilateral element can be split into two triangles by clicking anywhere in the interior of the element. This tool is useful if a pair of triangles is inadvertently merged.

Splitting Quadrilaterals

Occasionally it is necessary to split quadrilateral elements into triangular elements. For example, in order for new nodes to be automatically inserted into a mesh, the elements in the region where the node is inserted must be triangular. Also, in order to process a breakline, the elements in the region of the breakline must be triangular. In such situations, it

may be necessary to split a group of quadrilateral elements into triangular elements. Two options are provided for splitting quadrilateral elements:

- **The Split Quads Command** – The **Split Quads** command in the *Mesh* menu can be used to split a group of quadrilateral elements into triangular elements. If no elements are selected, all of the quadrilateral elements in the mesh are split. If some elements have been selected, only the selected quadrilateral elements are split.
- **The Merge/Split Tool** – The other option for splitting quadrilateral elements involves the use of the **Merge/Split** tool in the *2D Mesh Tool Palette*. If the Merge/Split tool is selected, clicking anywhere in the interior of a quadrilateral element with the mouse cursor will cause the element to be split into two triangles. The shortest diagonal through the quadrilateral is chosen as the common edge of the two new triangular elements

Refining Elements

In some cases, a mesh does not have enough elements in a particular region of the mesh to ensure stability. Rather than inserting supplemental nodes and re-creating the mesh, it is possible to refine a selected region of the mesh using the **Refine Elements** command in the *Mesh* menu. This increases the mesh density of a selected area of the mesh. If no elements are selected, the entire mesh is refined. The elevations of the new nodes are interpolated from the existing nodes.

Change Element Materials

Elements can have a material ID associated to it. The **Materials** command in the *Edit* menu brings up the *Material Editor* dialog. The material ID associated with the element can be changed using the **Properties** command in the *Edit* menu. (See [Materials](#))

Boundary Triangles

The perimeter of the TIN resulting from the triangulation process corresponds to or approximates the convex hull of the TIN vertices. This may result in some long thin triangles or "slivers" on the perimeter of the triangulated region. There are several ways to deal with the long thin triangles. Thin triangles can be selected and deleted using the normal selection

procedures. There is also an option for selecting thin triangles when the **Select Triangles** tool is selected. If the *Control* key is held down, it is possible to drag a line with the mouse. All triangles intersecting the line are selected. Long thin triangles on the perimeter of the TIN can also be selected by selecting the **Select Boundary Triangles** command from the *TINs* menu. The **Select Boundary Triangles** command checks triangles on the outer boundary first. If the length ratio of the triangle is less than the critical length ratio, the triangle is selected and the triangles adjacent to the triangle are then checked. The process continues inward until none of the adjacent triangles violate the minimum length ratio. The critical length ratio for selecting thin triangles can be set by selecting the *TINs* | **TIN Settings** menu command. The length ratio is defined as the longest side of the triangle divided by the sum of the two shorter sides.

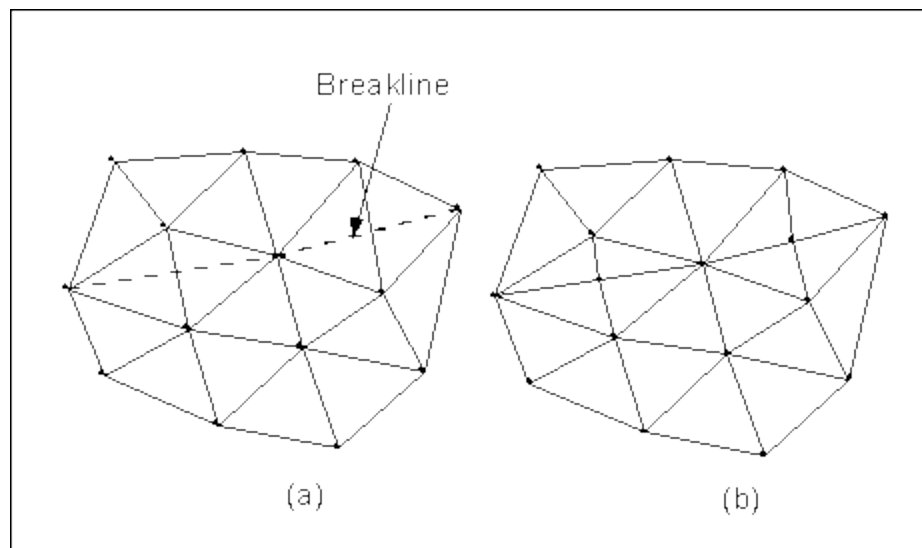

Breaklines (a) Triangulated Mesh and Breakline. (b) Triangulated Mesh After the Breakline has been Processed.

Breaklines

A breakline is a feature line or polyline representing a ridge or some other feature to be preserved in a mesh made up of triangular elements. In other words, a breakline is a series of edges to which the triangles should conform to, i.e., not intersect.

Breaklines can be processed using the **Add Breaklines** command from the *Mesh* menu. Before selecting the command, one or more sequences of nodes defining the breakline(s) should be selected using the **Select Node Strings** tool in the *2D Mesh Tool Palette*.

As each breakline is processed, the triangles intersected by the breakline are modified by adding new nodes at necessary locations to ensure that the edges of the triangles will conform to the breakline. The elevations of the new nodes are based on a linear interpolation of the breakline segments. The locations of the new nodes are determined in such a way that the [Delauney criterion](#) is satisfied.

2D Mesh Settings

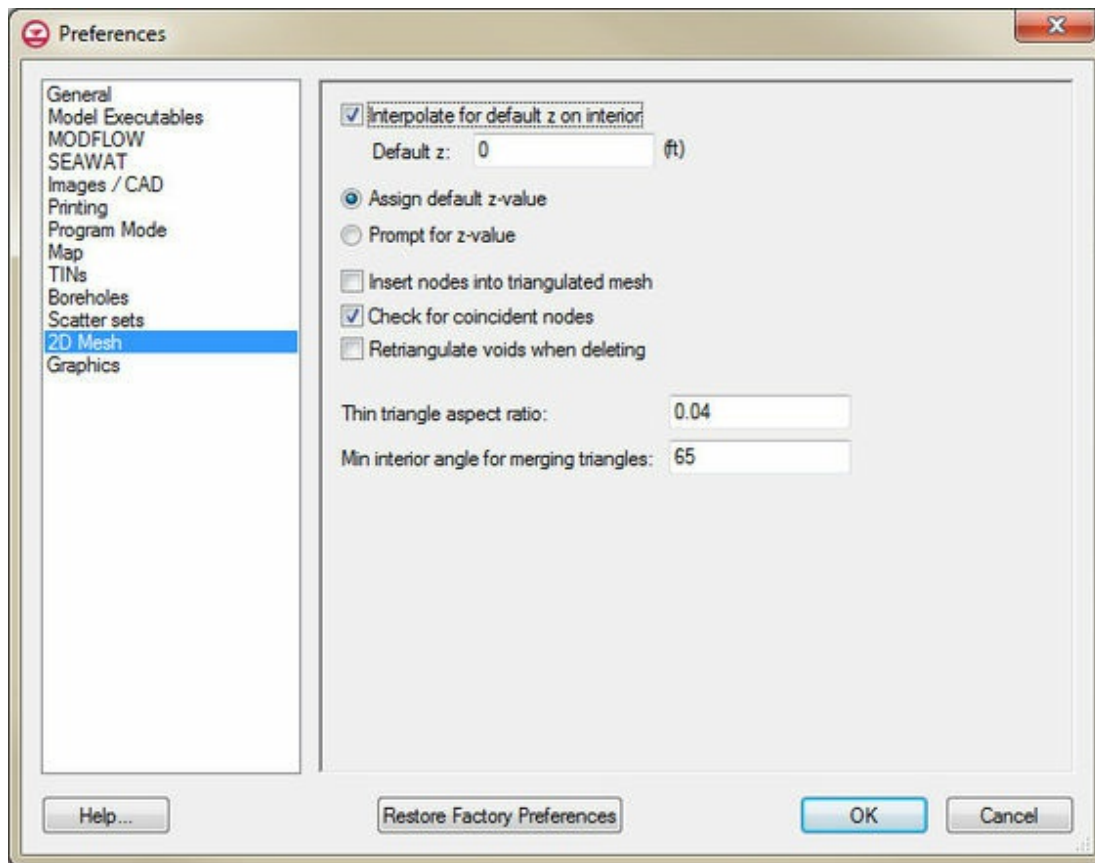

The Preference dialog showing the 2D Mesh tab

New nodes in a 2D mesh are created by selecting the **Create Nodes** tool from the [2D Mesh Tool Palette](#) and clicking where the new node is to be located. The default parameters governing the creation of new nodes can be specified using the **2D Mesh Settings** command in the *Mesh* menu. This brings up the *2D Mesh* tab of the *Preferences* dialog. The options in the dialog are as follows:

Default Z

If the check box entitled *Interpolate for default z on interior* is selected when a new node is inserted in the interior of the mesh, the element enclosing the node is linearly interpolated to get the Z value. If the node is on the exterior of the mesh, the default z value is used. If the toggle is not selected, the default Z is used everywhere.

The options in the center of the dialog are used to specify whether to use a default Z value for all new nodes or to have GMS prompt for the Z value every time a new node is created.

Insert Nodes into Triangulated Mesh

If the check box entitled *Insert nodes into triangulated mesh* is selected, any new node that lies in a region of the mesh consisting of triangular elements will automatically be incorporated into the mesh. New nodes will not be automatically incorporated into quadrilateral meshes.



Check for Coincident Nodes

If the check box entitled *Check for coincident nodes* is selected, any new node created using the **Create Nodes** tool will be checked to see if it lies on top of an existing node.

Thin Triangle Aspect Ratio

Sets the minimum aspect ratio for determining thin triangles in the mesh. Triangles with an aspect ration below the entered value can be selected using the **Select Thin Triangles** command or highlighted in the 2D Mesh display options.

2D Mesh Display Options

The properties of all [2D mesh](#) data that GMS displays on the screen can be controlled through the *2D Mesh* tab of the [Display Options](#) dialog. This dialog is opened by right-clicking on " 2D Mesh Data" in the [Project Explorer](#) and selecting the **Display Options** command. It can also be accessed from the from the *Display* menu or the **Display Options**  macro. The following table describes the display options available for the 2D Mesh module.



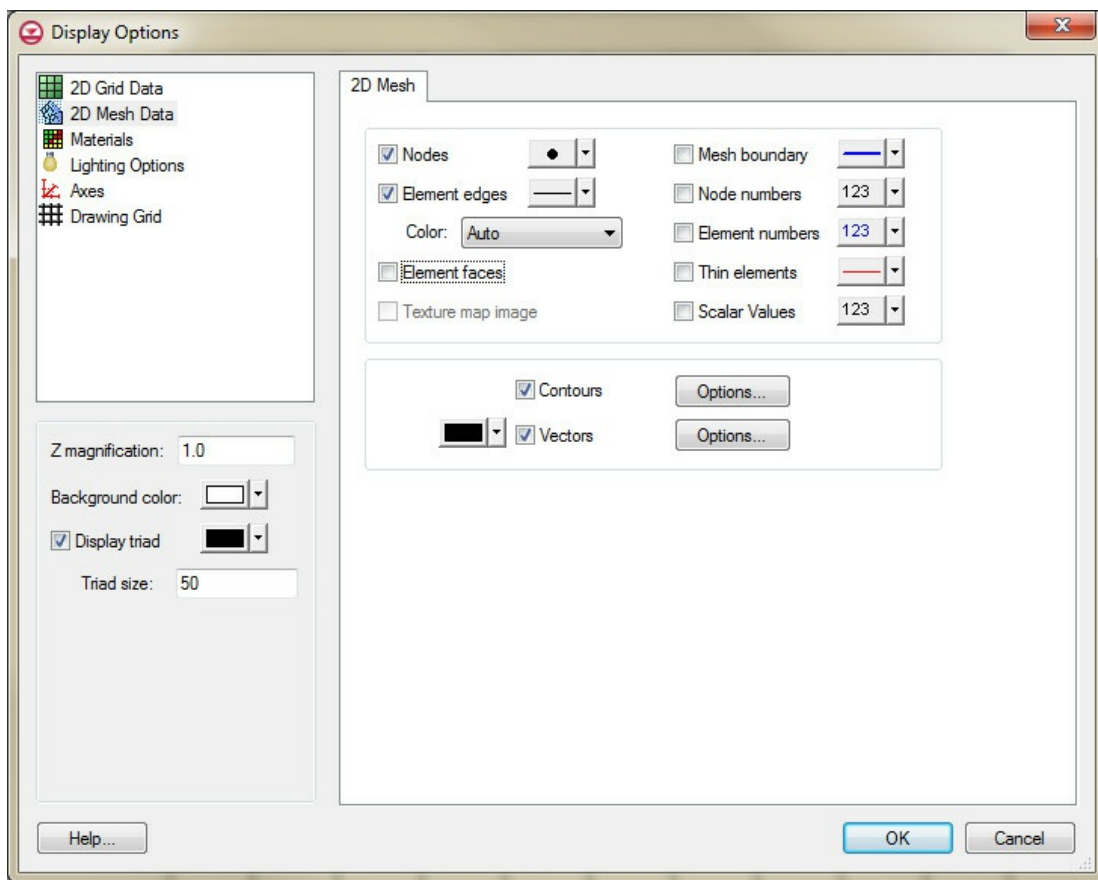









Display Option	Description
Nodes	Displays mesh nodes. A small circle is drawn at each node.
Element edges	Displays the edges of elements. The elements can be drawn using either the default color for elements or using the color of the material associated with each element. The color of the element edges can be adjusted according to the following options: <ol style="list-style-type: none">1. Auto – draws the material color if faces are not displayed. Uses black or white if the faces are displayed.2. Specified – used the color specified next to the cell edges3. Material – displays the material color of the cell
Element faces	This option fills the elements with the material color.
Texture map image	Used to "drape" an image over the surface of the 2D Mesh.
Mesh boundary	Displays a solid line around the perimeter of the mesh. Displaying the boundary is useful when contours are being displayed with the element edges turned off.
Node numbers	Displays the ID associated with each node next to the node.
Element numbers	Displays the ID associated with each element at the centroid of the element.
Thin elements	When set, triangular elements with small aspect ratios are highlighted. The minimum aspect ratio can be set using the <i>Thin triangles aspect ratio</i> option in the 2D mesh <i>Preferences</i> dialog.
Scalar values	Displays the scalar values of the active dataset for each node next to the node.
Contours	Most of the objects supported by GMS can be contoured by turning on the Contours option in the <i>Display Options</i> dialog. When an object is contoured, the values associated with the active dataset for the object are used to generate the contours.





The Display Options dialog showing the 2D Mesh tab.

2D Mesh Tool Palette

The following tools are contained in the dynamic portion of the [tool palette](#) when the [2D Mesh module](#) is active. Only one tool is active at any given time. The action that takes place when clicking in the [Graphics Window](#) depends on the current tool. The following table describes the tools in the 2D Mesh tool palette.

Tool	Tool Name	Description
	Select Nodes	The Select Nodes tool is used to select a set of nodes for some subsequent operation such as deletion. The coordinates of a selected node can be edited by dragging the node while this tool is active. The coordinates of selected nodes can also be edited using the Edit Window . A node can also be selected by using the Find Node command in the <i>Mesh</i> menu. A prompt will ask for a node ID and the node is selected. Any previously selected nodes are unselected.
	Select Elements	The Select Elements tool is used to select a set of elements for operations such as deletion or assigning a material type. An element can also be selected by using the Find Element command in the <i>Mesh</i> menu. A prompt will ask for an element ID and the element is selected. Any previously selected elements are unselected.
	Select Node Strings	<p>The Select Node Strings tool is used to select one or more strings of nodes. Node strings are used for operations such as adding breaklines to the mesh.</p> <p>The procedure for selecting node strings is somewhat different than the normal selection procedure. Strings are selected as follows:</p> <ul style="list-style-type: none"> Click on the starting node for the string. The node selected will be highlighted in red. Click on any subsequent nodes to add to the string (nodes do not have to be adjacent). The selected nodes are now connected by a solid red line. <p>To remove the last node from a string, press the Backspace key. To abort entering a node string, press the <i>ESC</i> key. To end a node string, press Return or double-click on the last node in the string. Another node string can then be selected.</p>
	Create Nodes	The Create Nodes tool is used to manually add nodes to a mesh. When this tool is selected, clicking on a point within the Graphics Window will place a node at that point. What happens to the node after it is added (whether and how it is triangulated into the mesh) depends on the settings in the <i>Node Options</i> dialog in the <i>Modify Mesh</i> menu.
	Create Linear Triangle Element	<p>Four types of elements are supported by the 2D Mesh module:</p> <ol style="list-style-type: none">  Three node triangles (linear triangles).  Six node triangles (quadratic triangles).  Four node quadrilaterals (linear quadrilaterals).  Eight node quadrilaterals (quadratic quadrilaterals).
	Create Quadratic Triangle Element	
	Create Linear Quadrilateral Element	
	Create Quadratic Quadrilateral Element	
		<p>Elements can be created using automatic meshing techniques such as triangulation. However, it is often necessary to edit a mesh by creating elements one at a time using the four Create Element tools. See the "Creating an Element" section below.</p>

	Element	
	Merge/Split	<p>If the Merge/Split tool is selected, clicking on a triangle edge with the mouse cursor will cause the two triangular elements adjacent to the edge to be merged into a quadrilateral element provided that the quadrilateral shape formed by the two triangles is not concave.</p> <p>The Merge/Split tool can also be used to undo a merge or to "unmerge" a quadrilateral element. A quadrilateral element can be split into two triangles by clicking anywhere in the interior of the element. This tool is useful if a pair of triangles are inadvertently merged.</p>
	Swap Edges	<p>If the Swap Edges tool is selected, clicking on the common edge of two adjacent triangles will cause the edge to be swapped as long as the quadrilateral shape formed by the two triangles is not concave.</p> <p>Occasionally, it is useful to interactively or manually swap the edges of two adjacent triangles. This can be thought of as a quick and simple alternative to adding breaklines to ensure that the edges of the triangular elements honor a geometrical feature that needs to be preserved in the mesh.</p>
	Contour Labels	<p>The Contour Label tool is used to manually place numerical contour elevation labels at points clicked on with the mouse. These labels remain on the screen until the contour options are changed, until they are deleted using the Contour Labels dialog, or until the mesh is edited in any way. Contour labels can be deleted with this tool by holding down the <i>Shift</i> key while clicking on the labels. This tool may only be used when the 2D mesh is in plan view.</p>

Creating an Element

A single element can be constructed from a set of existing nodes using the following steps:

1. Select the tool corresponding to the type of element to be created.
2. Select the nodes corresponding to the corner nodes of the element in consecutive order around the perimeter of the element. The nodes can be selected in either clockwise or counter-clockwise order. It is also possible to build an element by dragging a rectangle to enclose the nodes making up the new element rather than selecting each node one by one. A beep will sound if the wrong number of nodes for the current element type are selected.

If the current element type is a quadratic element (six or eight node element), the midside nodes of the element are created automatically. If the new element is adjacent to an existing element, the midside node of the existing element is used for the new element and a new midside node is not created, i.e. midside nodes are not duplicated. The coordinates of midside nodes cannot be edited. Midside nodes are always assumed to be located at the midpoint of the two adjacent corner nodes. When a corner node is edited, the coordinates of the adjacent midside nodes are updated accordingly.

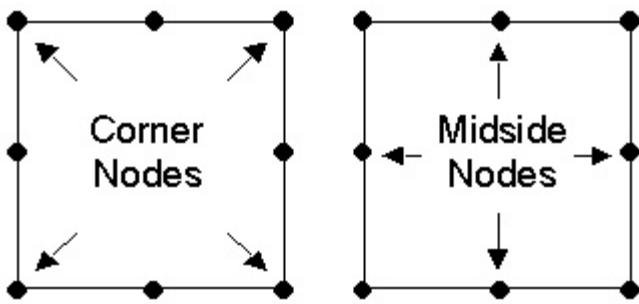

GMS performs several checks when a new element is constructed. The new element is checked to see whether or not it is ill-formed (the element has a twist in it or is self intersecting). The element is also checked to see if it overlaps any of the elements adjacent to the nodes comprising the new element. In addition, the elements adjacent to a new element are checked to ensure that the elements are conforming, i.e. linear elements (three and four node elements) are not allowed to be placed adjacent to quadratic elements (six and eight node elements). If any of the above checks fail, the construction of the new element is aborted

Converting a 2D Mesh to Other Types of Data

2D meshes may be converted to other types of data used in GMS, such as a [TIN](#) or [2D scatter points](#). 2D meshes are converted by using the following commands in the grid menu:

Mesh → 2D Scatter Points

The **Mesh → 2D Scatter Points** command in the *Mesh* menu is used to create a new scatter point set using the nodes in a mesh. A copy is made of each of the datasets associated with the mesh and the datasets are associated with the new scatter point set.

Mesh → TIN

A new TIN can be created from a 2D finite element mesh by selecting the **Mesh → TIN** command from the Build *Mesh* menu. A triangle is created from each triangular element in the mesh and two triangles are created from each quadrilateral element in the mesh by splitting the quadrilateral element along the shortest diagonal.

Mesh → 3D Tets

The **Mesh→3D Tets** command in the *Mesh* menu is used to convert a 2D mesh to a 3D mesh of tetrahedron.

This command brings up the *Mesh→3D Tets* dialog. At the top of the dialog, select two datasets that will represent the Top elevation and the Bottom elevation of the 3D mesh. In general the top elevation dataset should be completely above the bottom elevation dataset. Also select how the 3D mesh will be extruded. There are two options: *Constant number of layers* and *Layers distributed by depth*. When using *Constant number of layers*, simply enter the number of layers in the edit field. When using the *Layers distributed by depth*, enter a maximum layer thickness for each material present in the 2D mesh in the spread sheet.

How it works

Specify a top and bottom elevation dataset and the 3D mesh is extruded between the two datasets. This process is illustrated in the figures below.

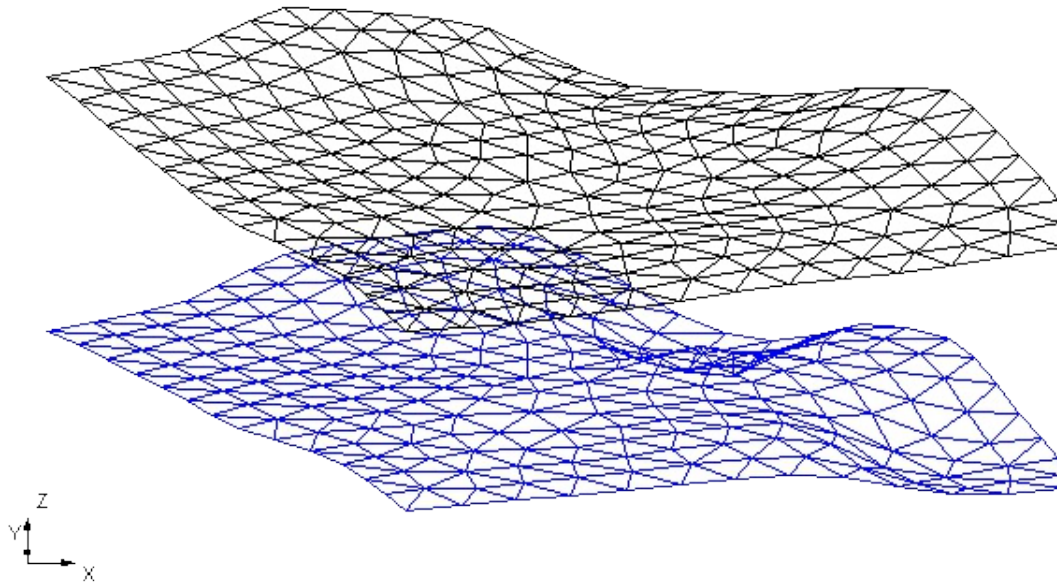

Two surfaces defining the top and bottom of the 3D mesh

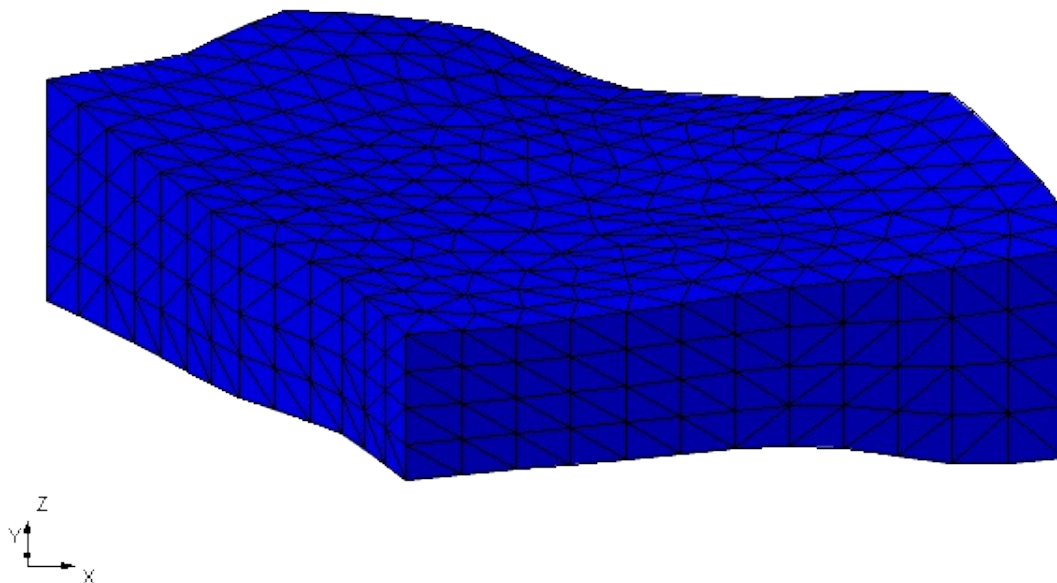

Tet mesh extruded between the top and bottom datasets

Two methods are available for determining the number of 3D mesh nodes to place between the two surfaces: *Constant number of layers* and *Layers distributed by depth*.

- The first option is a constant number of layers. The figure above was created by specifying 4 layers between the top and bottom surface. In this case five 3D mesh nodes are created between the top and bottom elevation datasets creating 4 layers.
- The second option uses the materials assigned to the 2D mesh. Then specify a maximum layer thickness for each of the materials. Then as the 3D mesh is extruded the number of nodes will vary depending on the material and the distance between the top and bottom elevation. This is illustrated in the figures below. The first figure show a 2D mesh with 3 materials assigned to it.

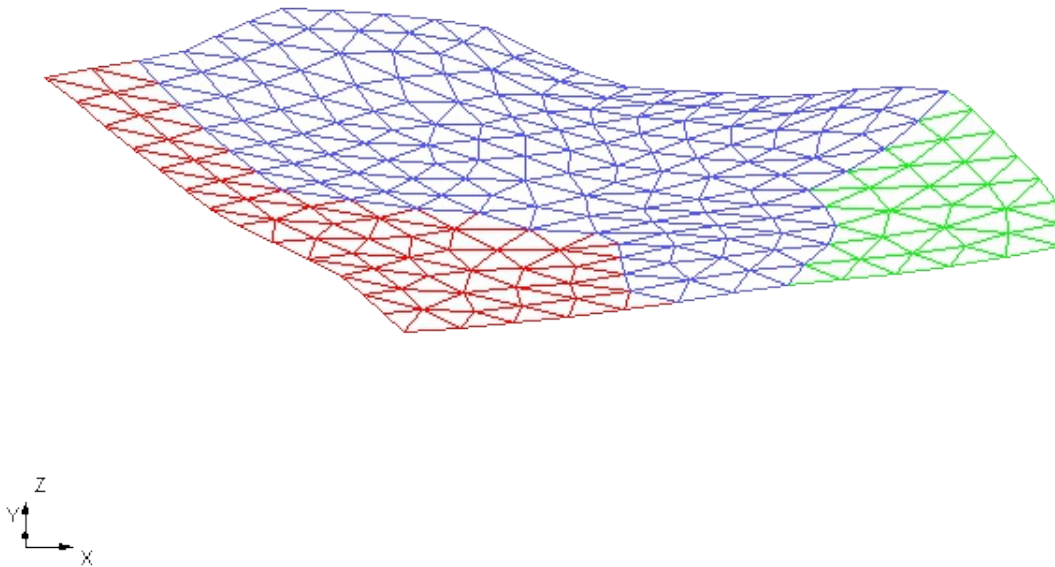

2D mesh with 3 materials

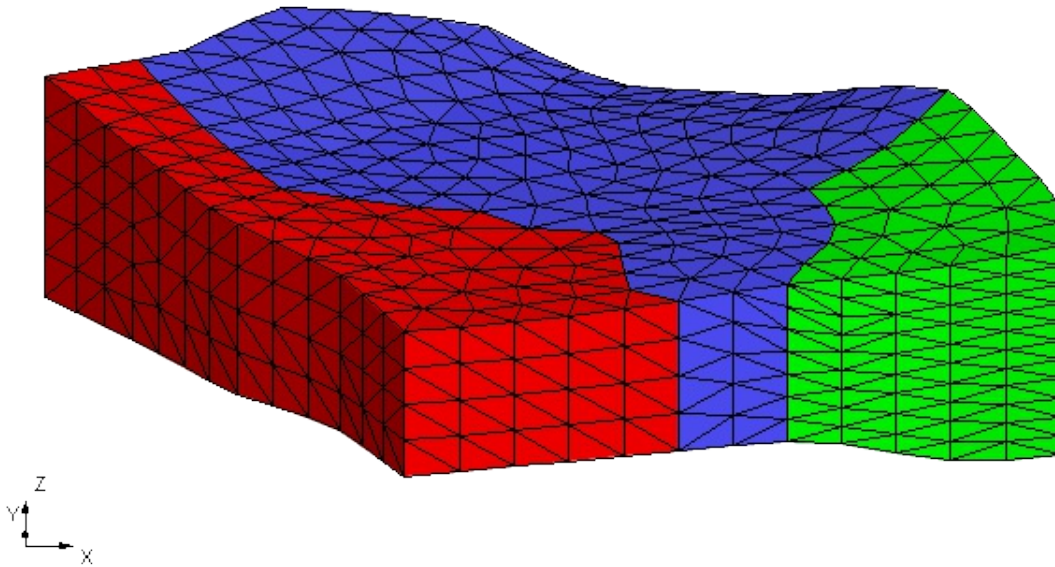



3D tet mesh created with materials and max layer thickness

A maximum layer thickness was assigned to each of the materials: red = 14.0 ft., blue = 10.0 ft., and green = 6.0 ft. The resulting 3D mesh is shown below.

Element Types

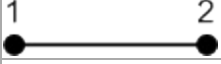
Element types used in XMS software.

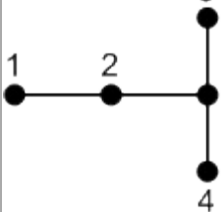
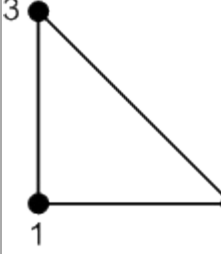
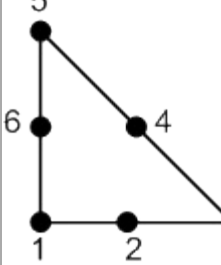
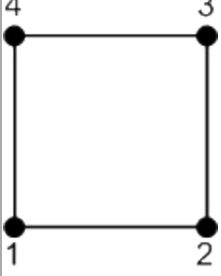
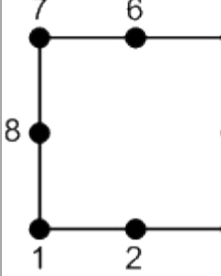
Element Type	Image	Faces
1D linear element with 2 nodes		
1D linear element with 3 nodes		
transition element		
2D linear triangle		
2D quadratic triangle		
2D linear quadrilateral		
2D quadratic quadrilateral		
2D quadratic quadrilateral with center node		

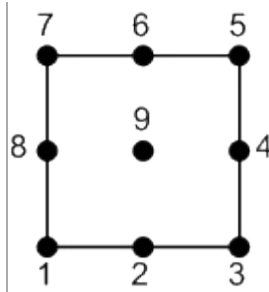

3D linear tetrahedron

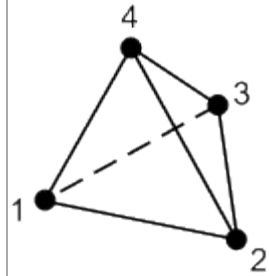

FaceID	Node Indices
1	2,3,4
2	1,4,3
3	1,2,4
4	1,3,2

3D linear prism

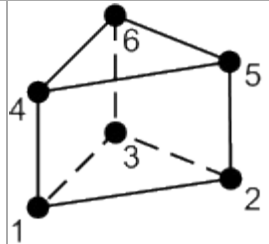

FaceID	Node Indices
1	1,3,2
2	4,5,6
3	1,2,5,4
4	2,3,6,5
5	3,1,4,6

3D linear hexahedron

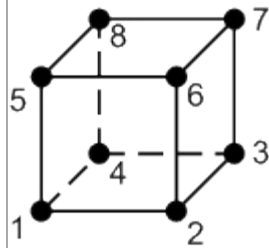

FaceID	Node Indices
1	1,4,3,1
2	5,6,7,8
3	1,2,6,5
4	2,3,7,6
5	3,4,8,7
6	4,1,5,8

3D linear pyramid

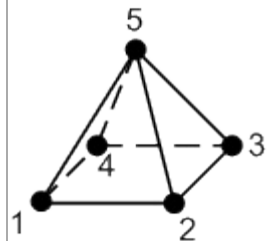

FaceID	Node Indices
1	1,4,3,2
2	1,2,5
3	2,3,5
4	3,4,5
5	4,1,5

2D Mesh Polygon Attributes

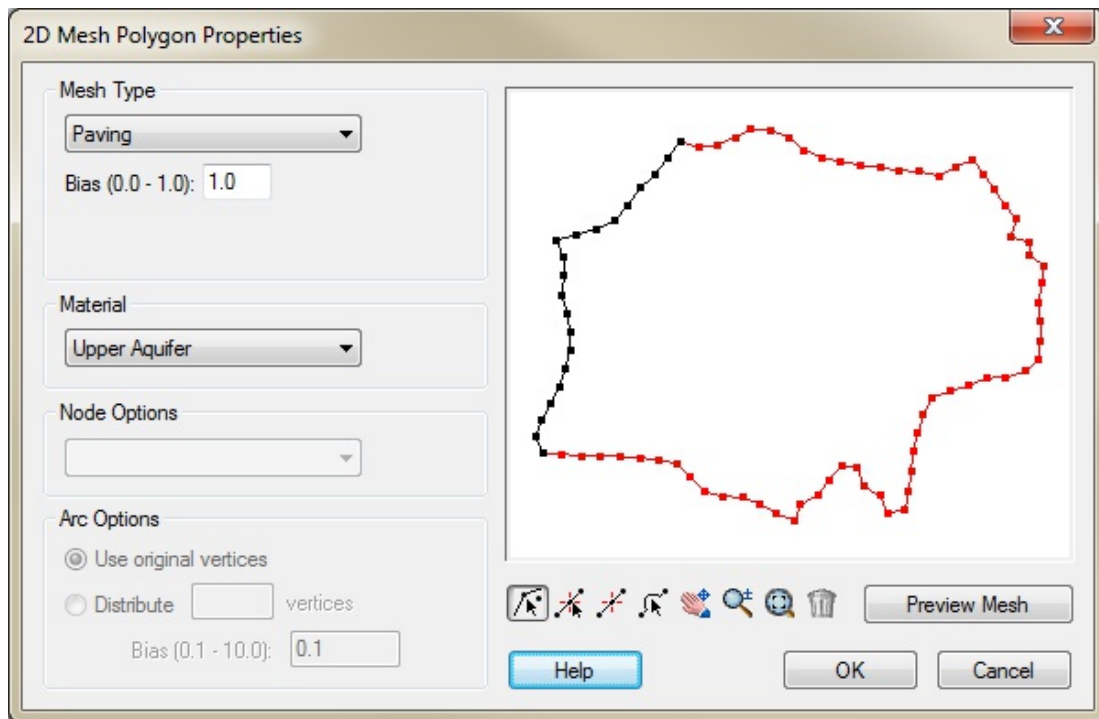

Example mesh created using adaptive tessellation

This dialog is used to set the attributes for feature polygons with a [SEEP2D](#) or [FEMWATER](#) coverage. The dialog is reached through the *Attribute Table* for a selected polygon in the map coverage. Attributes that can be specified for each polygon include:

Mesh Type

Set the meshing type to be used to fill the interior of the polygon. The options include (different options are given according the [coverage](#) type):

None

This results in a hole in the finite element network (no elements are created inside the polygon).

Adaptive Tessellation

Adaptive tessellation is a mesh generation technique used to fill the interior of a polygon. A polygon is assigned to be adaptive tessellation in the *Polygon Attributes* dialog and is filled with the **Map** → **2D Mesh** command.

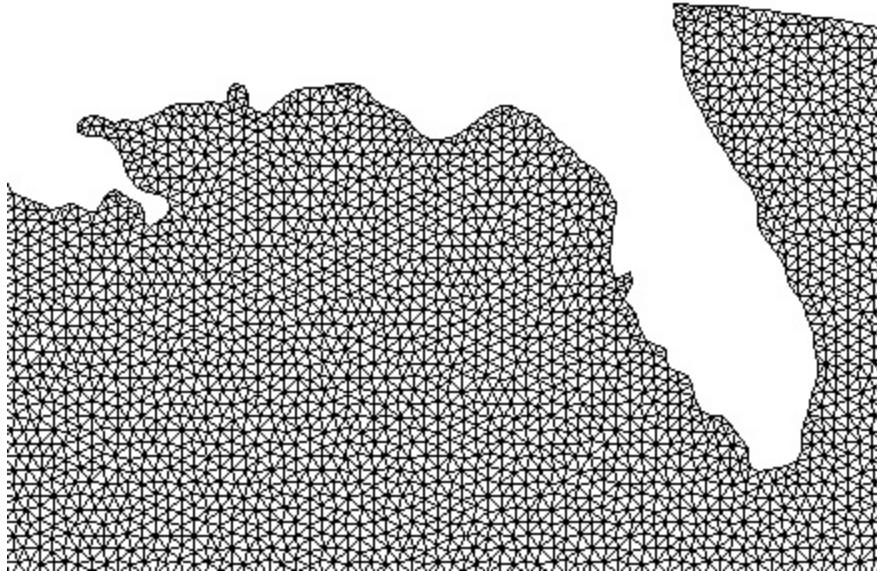

Example mesh created using adaptive tessellation

Adaptive tessellation uses the existing spacing on the polygons to determine the element sizes on the interior. Any interior arcs and refine points are forced into the new mesh. If the input polygon has varying node densities along its perimeter, GMS attempts to create a smooth element size transition between these areas of differing densities. By altering the size bias, it is possible to indicate whether GMS should favor the creation of large or small elements. Decreasing the bias will result in smaller elements; increasing the bias will result in larger elements. In either case, the elements in the interior of the mesh will honor the arc edges and the element sizes specified at nodes. The bias simply controls the element sizes in the transition region.

Patch

Map Patches

Patching is a mesh generation technique used to fill the interior of a polygon. A polygon is assigned to be a patch in the polygon attributes dialog and is filled with the *Feature Objects* | **Map** → **2D Mesh** command.

The coordinates of the new nodes on the interior of the patch are computed by constructing a partial bicubic Coons patch using the polygon as patch edges. This ensures that interior nodes are smoothly interpolated from the nodes making up the perimeter of the patch. Patches are applicable when the data points are gathered along parallel lines, such as cross sections in a river.

Rectangular Patches

The following are some hints when using rectangular patches:

The curvature of the patch can change somewhat, but it should not switch directions. If it does, then the patch should be split at the inflection point of the curve.

Although opposite sides in the rectangular patch are not required to have the same number of nodes, the best patches occur when this is close. In the example shown above, the two ends have the same number of nodes and the two sides only differ by three nodes.

Triangular Patches

All three sides of a triangular patch must have the same number of nodes.

Errors

When the patch is previewed in the polygon attributes dialog, the elements in a new patch are checked to make sure they do not overlap each other. If any problems are detected, an error message is given and the patch is not created. Errors may occur especially when the region is highly irregular in shape. In such cases, the region can either be divided into smaller patches, or it can be filled using a different mesh generation technique.

If a polygon cannot be patched, a help string under the preview window in the polygon attributes dialog explains what needs to be changed.

Paving

With paving the polygon boundary is "paved" inward until the interior is filled. The mesh triangles created from this method are aligned to the boundary.

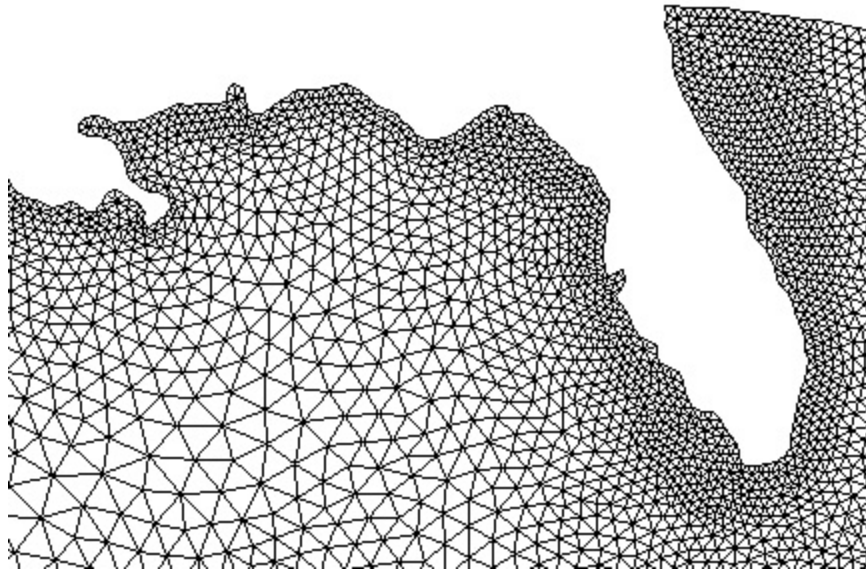

Example of a mesh created using paving





Polygon Type/Material

Polygons can be assigned a [Material](#) type.

Graphical Tools

The *Polygon Attributes* dialog includes a preview window on the left side. This window shows the arcs and nodes of the selected polygon and allows interacting with that definition. The **Preview** button generates the elements that will be created for the polygon. It is recommended that the preview is used with the patch and adaptive tessellation options only due to the time required performing density meshing. There are several tools for modifying the existing polygon. Zooming, panning and framing work in the preview window just as they normally would in the graphics window of GMS. They are used to facilitate the selection tools.

All entities are selected by clicking on the entity or by dragging a box to select several entities after selecting the tool. The graphical tools are described in the following table.

Tool	Tool Name	Description
	Select Vertex	Select a vertex in the window (red point on arc). Drag the vertex to move it.
	Create Vertex	Create a vertex by clicking on a red arc.
	Select Point/Node	Select a large blue or red node in the window.
	Select Arc	Selects arcs in the preview window.

Arc Options

The options dealing with selected arc(s).

- **Use original n nodes** – Use the original vertices on the arc (before entering the dialog). If a vertex is moved, deleted, or created using the above tools, clicking this option will not undo the vertex.
- **Distribute n nodes**. Specify the number of nodes and vertices to put on the arc (minimum of 2). The nodes are evenly spaced if the Bias is 1.0. A Bias of 2.0 will space the nodes more densely to one side; the last space will be twice as big as the first space. A Bias of 0.5 swaps this; the first space is twice as big as the last.

Node Options

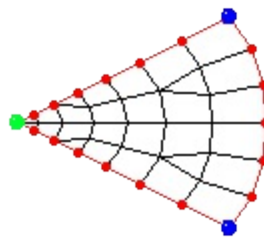

Example of the node options

The options dealing with selected node(s). These options are used for patches. Patches require 3 or 4 edges. An edge is an arc segment from one blue point to another blue point.

- **Split** – Split two merged arcs. This turns the node blue.

- **Merge** – Merge two arcs. This turns the node red.
- **Degenerate Edge** – This works with 4-sided patches. The degenerate node is treated as an edge, as shown in the figure below.

2D Mesh Commands

When the 2D Mesh module is active, the *Mesh* menu becomes available. The *Mesh* menu has two submenus: *Convert To* and *Advanced*. Below is a list of all commands in the *Mesh* menu:

New 2D Mesh

Creates a new, empty 2D mesh.

2D Mesh Settings...

Opens the 2D mesh settings which include: default z values for new nodes, options for deleting triangles etc.

Lock All Nodes

Since it is possible to accidentally drag points, nodes can be "locked" to prevent them from being dragged or edited by toggling on this command.

Find Element...

Selects an element given the element ID.

Find Node...

Selects a node given the node ID.

Triangulate

Creates triangular elements from all or selected nodes using the Delauney criteria. If triangles already exist, they will be deleted.

Renumber

Renumbers mesh nodes eliminating gaps in numbering. Optionally a [node string](#) can be created and used to guide the renumbering.

Z Values → Dataset

Creates a dataset from the Z locations of the nodes.

Map to Z Values

Moves the Z locations of the nodes to the values in the dataset.

Zoom To Extents

Frames the Graphics Window around the selected objects.

***Convert To*>**

Mesh → 2D Scatter Points

A new 2D scatter point set is created from the 2D mesh nodes.

Mesh → TIN

A new TIN is created from the 2D mesh.

Contours → Arcs

Creates a new coverage containing feature arcs derived from the linear contours displayed on the 2D mesh.

***Advanced*>**

Select Thin Triangles

Selects triangles which meet the "thin triangle aspect ratio" specified in the 2D mesh settings.

Find Duplicate Nodes...

Selects nodes that are close to each other within a user specified tolerance.

Merge Triangles

Used to convert triangular elements into quadratic elements.

Split Quadrilaterals

Used to convert quadrilateral elements into triangular elements.

Add Breaklines

Inserts the node strings into the mesh as a new edge, creating new elements and nodes.

Convert Elements

Converts linear elements to quadratic and quadratic elements to linear.

Refine Elements

Subdivides elements into smaller elements.

Relax Elements...

Moves mesh nodes in order to improve the quality (element shape and size) of the mesh.

Mesh → 3D Tets

Creates a 3D mesh consisting of tetrahedron from the 2D mesh.

Export

Exports a 2D mesh to a file (*.2dm, *.fem etc).

Related Topics

- [2D Mesh Module](#)
- [Converting a 2D Mesh to other types of Data](#)

5.5. 2D Grid Module

2D Grid Module

The 2D Grid module is used for creating and editing two-dimensional Cartesian grids. A number of [tools](#) are provided for working with 2D grids. Currently, GMS only allows one 2D grid per project.

2D grids are primarily used for surface visualization and [contouring](#). This is accomplished by [interpolating](#) to the grid. The figure below is an example of interpolating contaminant concentration data to a 2D grid.

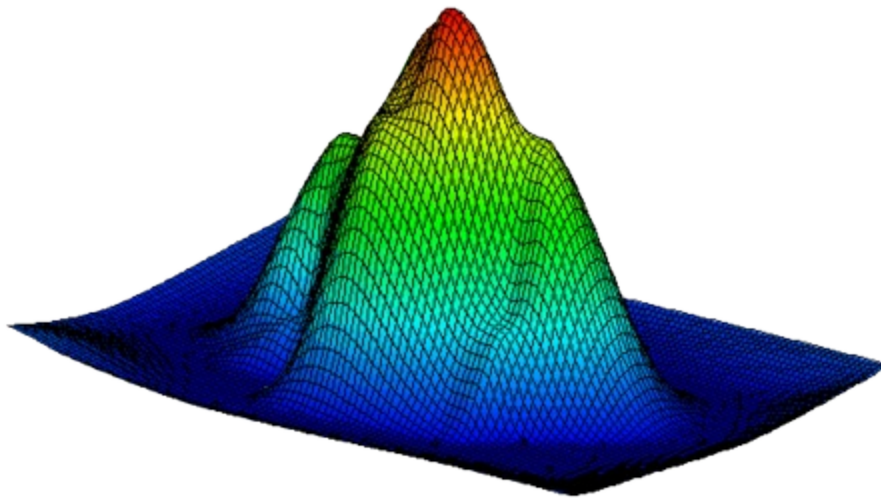

Concentration data interpolated to a 2D grid

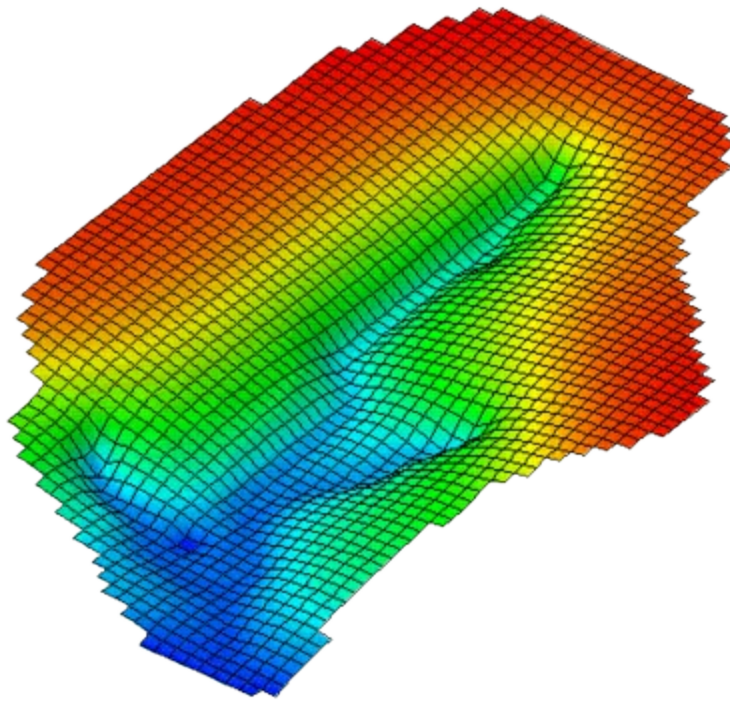

Watertable elevations from a MODFLOW simulation

2D Grid Types

Two types of grids are supported in the 2D Grid module: mesh-centered grids and cell-centered grids. With a mesh-centered grid, the data values are stored at the corners of the grid cells. With a cell-centered grid, data values are stored at the cell centers.

When a [dataset](#) is imported to a cell-centered grid, there is one value in the dataset for each cell. The [contouring](#) and [fringing](#) functions use scalar values at the cell corners. Therefore, whenever contouring or fringing is performed, the values at the cell centers are interpolated to the cell corners. Interpolation to cell corners is only done for visualization purposes. All computations performed using the data calculator are performed on the original values at the cell centers. With mesh-centered grids, all visualization and computations are performed at the cell corners and no interpolation is necessary.

Grids in GMS are Cartesian grids. That is, the row and column spacing in the grid can vary, but the row and column boundaries are straight. Each cell center or grid node can have a unique elevation. The grid can also be rotated about the Z axis if desired.

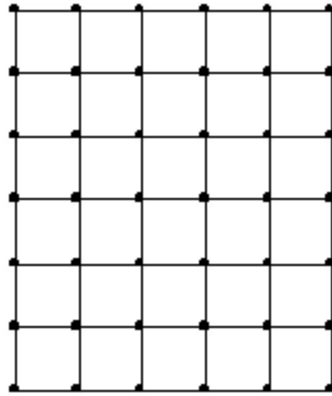

(a)

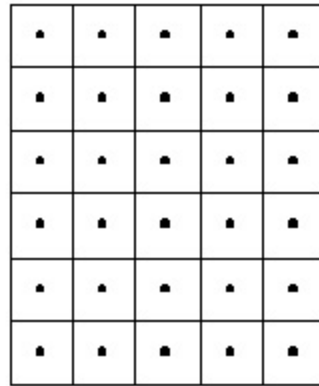

(b)

Types of 2D grids supported in GMS. (a) Mesh-centered grid (b) Cell-centered grid.

See also

- [Importing/Exporting GIS Grids](#)

2D Grid Creation and Editing

GMS provides two methods for creating 2D grids and multiple ways to edit a 2D grid.

Creating 2D Grids

Two types of 2D grids are supported by GMS, [mesh centered and cell centered](#). The two main techniques used to create 2D grids are: the **Create Grid** command and the **Map → 2D Grid** command. A 2D grid can also be created from an existing 3D grid using the **Grid → 2D Grid** command in the *Grid* menu of the [3D Grid Module](#). A [GIS grid](#) may also be imported.

Create Grid

A new grid can be created by selecting the **Create Grid** command from the *Grid* menu. This command brings up the *Create Grid* dialog. The options in the dialog are as follows:

- **Origin, Length, Rotation** – By default, the rows and columns of [2D grids](#) are aligned with the x and y axes. However, grids can be rotated about the z-axis, if desired. Thus, the information needed to determine the overall size and location of the grid is the xy coordinates of the lower left corner of the grid (the lower left corner prior to rotation), the length of the grid in the x and y directions, and the rotation angle. The xy coordinates of the origin are entered in the Origin edit fields, the dimensions are entered in the Length fields, and the angle of rotation is entered in the field entitled Rotation about Z-axis.
- **Bias** – Several options are available for defining the number and locations of the cell boundaries. A bias can be defined which controls how the cell size varies from one cell to the next. For example, an X bias of 1.5 causes each cell to be 50% larger than the previous cell when moving in the positive x direction.
- **Number of Cells** – The total number of cells in each direction (number of rows or

columns) can be defined by explicitly entering a number or by entering a base cell size and a limit cell size. The base and limit cell size options are used when a bias other than 1.0 is specified. The base cell size is the size of the first cell in the sequence. The cells are then generated by altering the cell size according to the bias until the limit cell size is reached. The remainder of the cells are constructed using the limit cell size.

- **Type and Orientation** – The controls at the bottom of the *Create Grid* dialog are used to define the type and orientation of the grid. The user can specify whether the grid should be a mesh-centered grid or a cell-centered grid. The orientation of the ij axes with respect to the XY axes can also be specified.

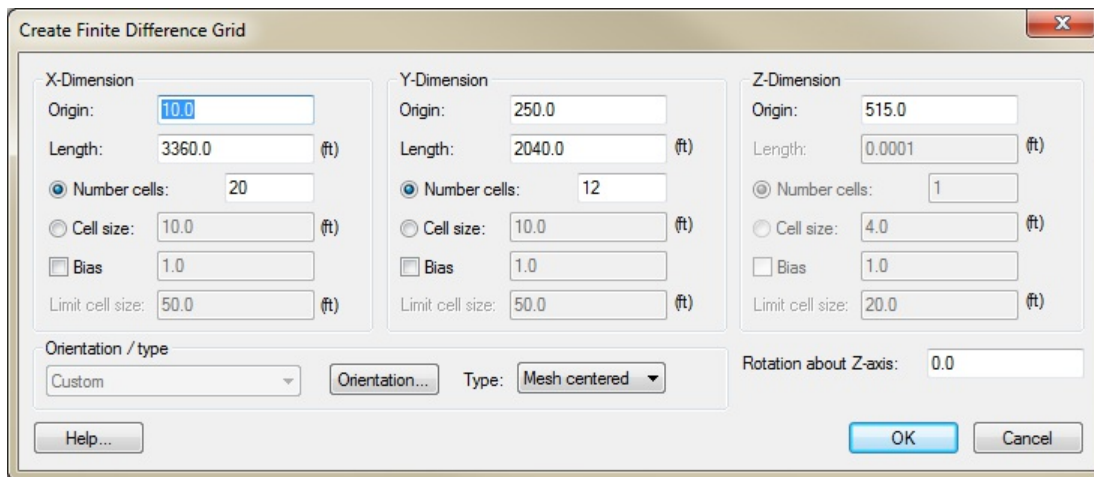

The Create Finite Difference Grid dialog

Map → 2D Grid

The **Map → 2D Grid** command is used to construct a 2D grid using the feature objects in a 2D grid coverage. When the **Map → 2D Grid** command is selected, the *Create Grid* dialog appears. If a grid frame has been defined, the size and location of the grid frame are used to initialize the fields in the *Create Grid* dialog. In most cases, these values will not need to be changed so simply select the **OK** button to create the grid. If a grid frame has not been defined, the size and location of the grid are initialized so that the grid just surrounds the currently defined feature objects. If desired, the grid dimensions can be edited prior to selecting the **OK** button to create the grid.

If one or more refine points are defined in the conceptual model (available when

"Refinement" is selected in the [Coverage Setup](#) dialog), the number of rows and columns in the grid will be automatically determined when the grid is created. Thus, these fields cannot be edited and will be dimmed. If refine points are not defined, enter the number of rows and columns.

Editing 2D Grids



Each of the cells in a 2D grid can be active or inactive. An inactive cell is ignored when contours, fringes, or vectors are displayed on the mesh.

Each cell in the grid has an associated material type. When a new grid is created, the material type for each cell corresponds to the default material type. The default material type can be set using the [Materials Editor](#) command in the *Edit* menu. A new material can be assigned to a cell or a set of cells by selecting the cell(s) and then selecting the **Properties** command from the *Edit* menu.



Inserting Rows and Columns

Rows and columns can be added to an existing 2D grid by using the **Add i Boundary** tool and the **Add j Boundary** tool. Also, the interface between a row and a column can be moved by using the **Move Boundary** tool. (See [2D Grid Tool Palette](#))

Merging Rows and Columns

Rows or columns can be merged together by selecting the rows or columns using the **Select i**  or **Select j**  tools, right-clicking and selecting the **Merge** command from the pop-up menu. This command is the same as the **Merge Cells** command in the [Grid menu](#) in the main menu bar.

2D Grid Display Options

The properties of all [2D Grid](#) data that GMS displays on the screen can be controlled through the *2D Grid* tab of the [Display Options](#) dialog. This dialog is opened by right-clicking on the 2D Grid Data  entry in the [Project Explorer](#) and selecting the **Display Options** command. It can also be accessed from the *Display* menu or the **Display Options**  macro. The following table describes the display options available for the 2D Grid module.



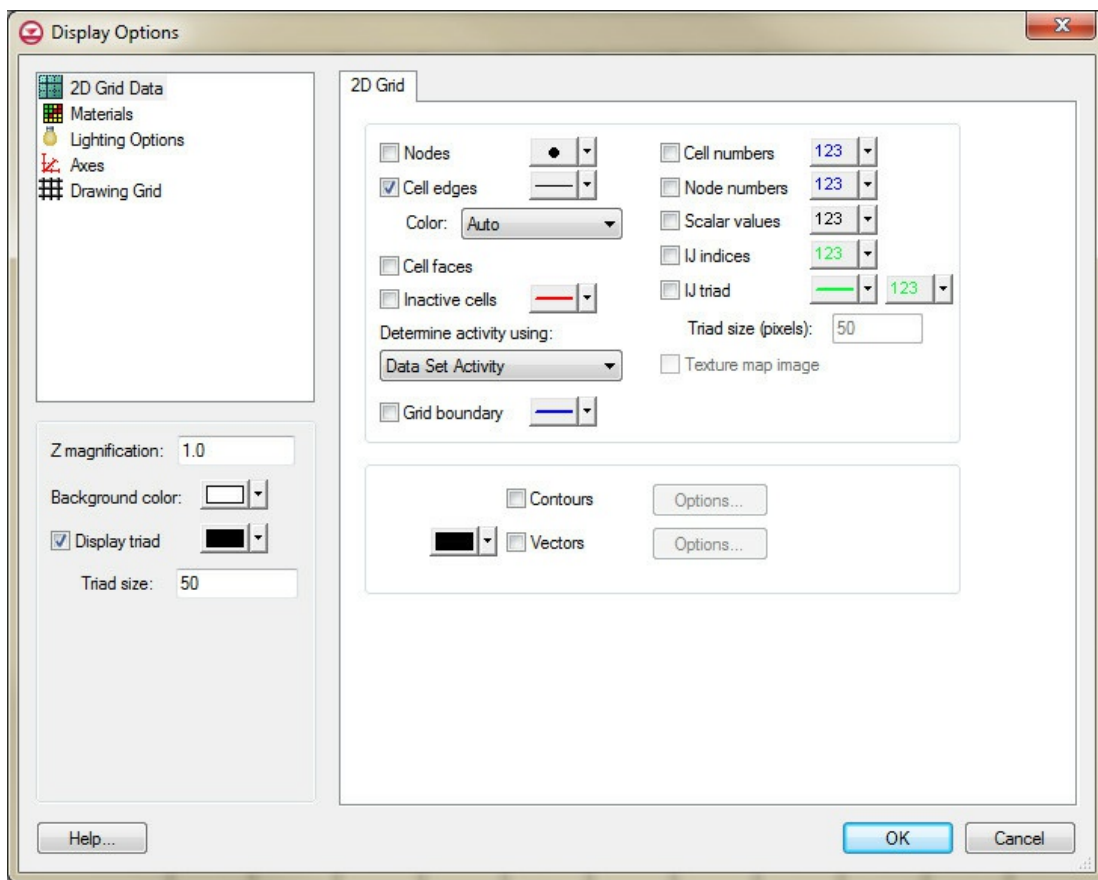



Display Option	Description
Nodes	The <i>Nodes</i> item is used to display grid nodes on the corners of the cells for both mesh- and cell-centered Grid Types .
Cell edges	<p>The <i>Cell edges</i> item is used to display the edges of grid cells. The cells are either drawn using the default cell color or the color of the material associated with each cell.</p> <p>In addition to turning the display of cells on or off, grid cells can be temporarily hidden.</p> <p>The color of the cell edges can be adjusted according to the following options:</p> <ol style="list-style-type: none">1. Auto – draws the material color if faces are not displayed. Uses black or white if the faces are displayed.2. Specified – used the color specified next to the cell edges3. Material – displays the material color of the cell
Cell faces	The <i>Cell faces</i> item causes the faces of the grid cells to be drawn as filled polygons.
Inactive cells	The <i>Inactive cells</i> item is used to display cells which are inactive. If this option is turned off, inactive cells are not displayed. Inactive cells must be displayed before they can be selected.
Grid boundary	The <i>Grid boundary</i> item is used to display a solid line around the perimeter of the grid. Displaying the boundary is useful when contours are being displayed with the cell edges turned off.
Cell numbers	The <i>Cell Numbers</i> item is used to display the ID of each grid cell.
Node numbers	The <i>Node Numbers</i> item is used to display the ID of each grid node.
Scalar values	The <i>Scalar Values</i> item is used to display the scalar values of the active dataset for each node next to the node.
IJ indices	The <i>IJ indices</i> item is used to display the ij indices of each cell or node.
IJ triad	The <i>IJ triad</i> item is used to display a symbol at one of the corners of the grid showing the orientation of the ij axes.
Texture map image	The <i>Texture map image</i> item is used to "drape" an image over the surface of the 2D Grid.
Contours	Most of the objects supported by GMS can be contoured by turning on the Contour Options in the <i>Display Options</i> dialog. When an object is contoured, the values associated with the active dataset for the object are used to generate the contours.
Vectors	If the Vectors item in the <i>Display Options</i> dialog is selected for an object (TIN, Grid, or Mesh), vector plots can be generated using the active vector dataset for the object. One vector is placed at each node, cell, or vertex.



The Display Options dialog showing the 2D Grid tab.

2D Grid Tool Palette

The following tools are contained in the dynamic portion of the [tool palette](#) when the [2D Grid Module](#) is active. Only one tool is active at any given time. The action that takes place when clicking in the [Graphics Window](#) depends on the current tool. The following table describes the tools in the 2D grid tool palette.

Tool	Tool Name	Description
	Select Cell	<p>The Select Cell tool is used to select individual grid cells or grid nodes. Multi-selection can be performed by holding down the <i>SHIFT</i> key while selecting or by dragging a rectangle to enclose the cells to be selected. The ij indices of the selected cell are displayed in the Edit Window.</p> <p>Only visible cells can be selected. Cells which have been hidden cannot be selected. Inactive cells can only be selected when they are being displayed by turning on the <i>Inactive Cells</i> item in the Display Options dialog.</p> <p>To select specific cell based on the ij of the cell or by cell ID, use the Find Cell command in the <i>Grid</i> menu. The Find Grid Cell dialog provides edit fields for both an ID or an IJ value. Entering a value for ID will automatically update the IJ fields. Likewise, entering a value for the IJ location will automatically update the ID. When the OK button is selected, the indicated cell will be selected in the grid.</p> <p>In addition to selecting one cell at a time, the Find Grid Cell dialog can select an entire row column or layer. A zero may be entered in either of the I or J fields indicating that all cells in that direction will be selected. The ID of the cells that will be selected is also displayed as static text at the top of the dialog.</p>
	Select i	The Select i tool is used to select an entire "row" (set of cells with the same i index) of cells at once. Multi-selection can be performed by holding down the <i>SHIFT</i> key. The i index of the selected row is displayed in the Edit Window .
	Select j	The Select j tool is used to select an entire "column" (set of cells with the same j index) of cells at once. Multi-selection can be performed by holding down the <i>SHIFT</i> key. The j index of the selected column is displayed in the Edit Window .
	Select Node	The Select Node tool is used to select nodes and interactively edit cell boundary coordinates by clicking on the intersection of two cell boundaries and dragging the boundaries with the mouse button held down. The coordinates of the cell boundary intersection are displayed in the Edit Window as the boundaries are dragged. If the current view is not the plan view, the dragging movement is constrained to follow the Z axis. The coordinates of a selected boundary intersection can also be edited by directly entering the coordinates in the Edit Window .
	Add i Boundary	The Add i Boundary tool is used to insert a new i boundary into the grid. The new boundary is inserted at the cursor location when the mouse button is clicked. Inserting a new cell boundary changes the dimensions of the grid and all data sets associated with the grid are deleted. If the <i>control</i> key is held down while executing this command, the row will be evenly divided.
	Add j Boundary	The Add j Boundary tool is used to insert a new j boundary into the grid. The new boundary is inserted at the cursor location when the mouse button is clicked. Inserting a new cell boundary changes the dimensions of the grid and all data sets associated with the grid are deleted. If the control key is held down while executing this command, the column will be evenly divided.
	Contour Labels	The Contour Label tool manually places numerical contour elevation labels at points clicked on with the mouse. These labels remain on the screen until the contour options are changed, until they are deleted using the Contour Labels dialog, or until the grid is edited in any way. Contour labels can be deleted with this tool by holding down the <i>SHIFT</i> key while clicking on the labels. <i>This tool can only be used in plan view.</i>

Converting 2D Grids

2D Grids may be converted to other types of data used in GMS, such as a [TIN](#), [2D mesh](#), or [2D scatter points](#). 2D Grids can be converted by using the following commands in the *Grid* menu:

Grid → 2D Scatter Points

Creates a new scatter point set using the nodes or cells of the 2D grid. A copy is made of each of the datasets associated with the grid and the datasets are associated with the new scatter point set. A prompt will ask to name the new scatter set.

Grid → TIN

Creates a new TIN from the selected 2D grid. Two triangles are created from each cell in the grid. The *TIN Properties* dialog will appear before the conversion is completed allowing the new TIN to be named, assigned a material, and the TIN data can be reviewed.

Grid → 2D Mesh

Creates a new 2D finite element mesh from the 2D grid. A four node quadrilateral element is created from each cell in the grid. A prompt will ask whether to create the mesh using the cell center (centroids) or using the cell corners.

Grid → Ugrid

Creates a new unstructured grid using the 2D grid. The new [Ugrid](#) will use the dimension of the 2D Grid.

Contours → Arcs

Creates a new feature [coverage](#) containing arcs derived from the linear contours on the 2D grid. The command only works if linear contours are being [displayed](#).

2D Grid Commands

When the 2D Grid module is active, the *Grid* menu becomes active. The *Grid* menu contains one submenu; the *Convert To* submenu. The following commands are found in the *Grid* menu:

Create Grid...

Brings up the *Create Finite Difference Grid* dialog.

Merge Cells

Merges selected grid rows or columns into one grid row or column.

Find Cell...

The **Find Cell** command in the *Grid* menu opens a dialog that lets you find a grid cell or node by ID or by IJ (for 2D grids) or IJK (for 3D grids).

Find Node...

Selects a node given an ID or IJ coordinate.

Zoom To Extents

Frames the Graphics Window around the selected objects.

Convert To>

Grid → 2D Scatter Points

Creates a scatter point set with a point on the center of each cell with the value of the cell.

Grid → TIN

Creates a TIN based on cell centers of the grid.

Grid → 2D Mesh

Creates a mesh typically from the cell centered values in the grid for the different layers. The first dialog allows choosing between the cell centers or the cell corners to create the mesh. A disclaimer is given that data values are given at the cell center and that datasets will not be converted.

UGrid

Creates a Ugrid based on the grid dimensions.

Contours → Arcs

Converts layer contours into arcs that can be manipulated as drawing objects.

Right-click Menu

Right-clicking on 2D grid  item in the Project Explorer has the following additional commands:

Import Dataset

Allows opening datasets to be add values to the grid.

Related Topics

- [2D Grid Module](#)
- [Converting 2D Grids](#)

5.6. 2D Scatter Point Module

2D Scatter Point Module

The 2D Scatter Point module is used to interpolate from groups of 2D scattered data to other objects (meshes, grids, TINs). Several [interpolation](#) schemes are supported, including [Clough-Tocher](#), [inverse distance weighted](#), and [kriging](#).

Interpolation is useful for setting up input data for analysis codes and for site characterization. The two figures below show examples of using interpolation.

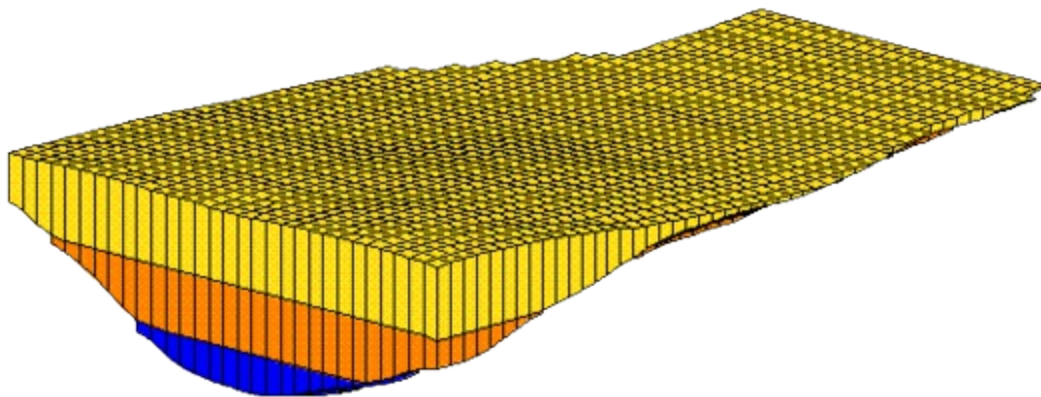

Interpolation of Modflow layer elevations to a 3D grid

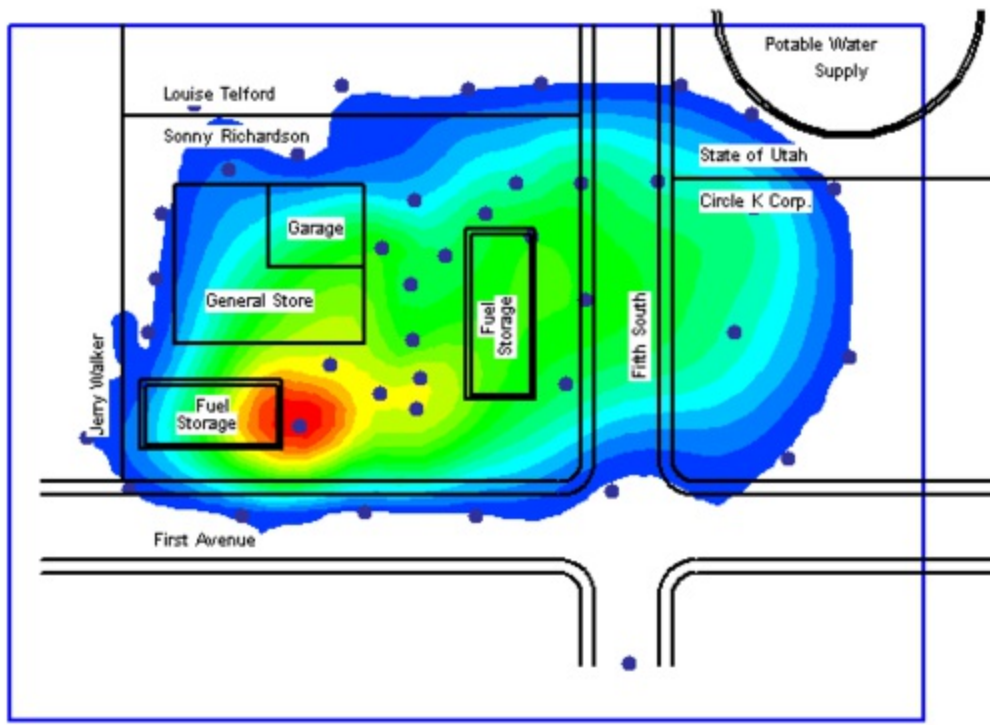

Sample interpolation for site characterization

A number of [tools](#) are included for creating and manipulating 2D scatter point sets. In general, 2D scatter sets are imported using the [File Import Wizard](#). 2D scatter sets can also be [created](#) from other objects in GMS such as GIS objects, feature objects, meshes, grids, TINs, etc.

Multiple 2D scatter sets can be in the module. Existing scatter sets can be duplicated or merged together.

Besides interpolating 2D scatter sets to other data, the module can also be used to [create objects \(meshes, grids, TINs\)](#) from the scatter data.

The module contains its own [display options](#) which include [contour](#) displays. Also, each scatter point has an [active/inactive](#) status. A scatter point with an inactive status can be displayed, but the dataset value at the point is ignored when interpolation takes place.

The 2D Scatter Point module also allows exporting scatter sets by right-clicking on the scatter set and selecting the **Export** command. Options for export include: Text Tab Delimited 2D Scatter Point Files (*.txt), Text GMS 2D Scatter Point Files (*.xy), and Shapefiles (*.shp).

2D Scatter Point Set Creation and Editing

Each of the points from which values are interpolated are called scatter points. A group of scatter points is called a scatter point set. Each of the scatter points is defined by a set of xy coordinates.

Each scatter point set has a list of scalar datasets. Each dataset represents a set of values which can be interpolated to a TIN, mesh, or grid.

Multiple scatter point sets can exist at one time in memory. One of the scatter point sets is always designated as the "active" scatter point set. Interpolation is performed from the active dataset of the active scatter point set only.

Creating Scatter Points

Scatter point sets can be created in one of three ways: interactively creating scatter points, converting from other data types, or importing from a file.

Interactively Creating Scatter Points

The **Create scatter point** tool is used to click out new scatter points in the GMS Graphics Window. The new scatter points are added to the active scatter point set. If wanting the new points in their own scatter point set, select the *Scatter Points* | **New Scatter Point Set** command.

Converting from Other Types

Scatter point sets are often created by converting from other data types (TINs, meshes, grids, boreholes). The following commands are available to convert an object to a scatter point set:

- [TIN → 2D Scatter_Points](#)
- [Contacts → 2D Scatter Points](#)

- [Watertable](#) → 2D Scatter Points
- [Grid](#) → 2D Scatter Points
- [Mesh](#) → 2D Scatter_Points
- [Map](#) → 2D Scatter Points
- [Modflow Layers](#) → 2D Scatter_Points

Importing Tabular Scatter Point Data

In most cases, scatter point sets are created by importing a text file through the [File Import Wizard](#).

Editing Scatter Points

The location of a scatter point can be edited by selecting the scatter point and dragging it to a new location or by typing in the new coordinates in the [Edit Window](#).

The dataset value associated with a scatter point can be edited using the edit field labeled "F:" in the [Edit Window](#). Dataset values can also be edited using a spreadsheet dialog by selecting the **Edit Values** button in the [Dataset Info](#) dialog.

In addition to the dataset values, each scatter point has three properties that can be edited on a point by point basis:

- label
- material
- [activity](#)
- Fixed pilot point

The label is a text string that can be displayed by turning on the ID option in the Display Options dialog. The material type is used for indicator simulations.

The fixed [pilot point](#) property is used with PEST(See [Automated Parameter Estimation](#)). If

this option is on, then the value at this point is not estimated during the parameter estimation process.

The scatter point properties can be edited by double-clicking on a point or by selecting a set of points and selecting the **Properties** command in the *Edit* menu.



Deleting Scatter Points

Individual scatter points can also be deleted. This command results in the removal of the point from all the datasets associated to the scatter point set.

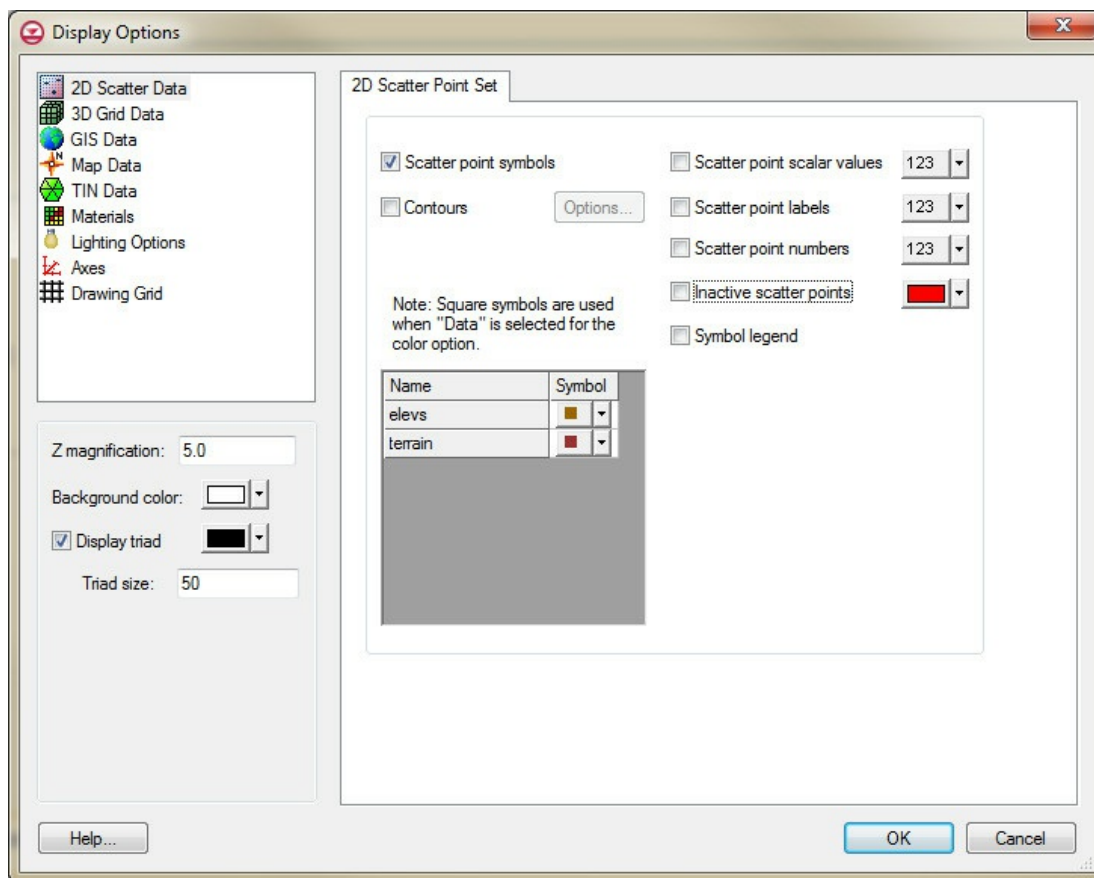
2D Scatter Point Display Options



The Display Options dialog showing the 2D Scatter Point Set tab.

The properties of all **2D scatter** data that GMS displays on the screen can be controlled through the **2D Scatter** tab of the **Display Options** dialog. This dialog is opened by right-clicking on the 2D Scatter Data  entry in the **Project Explorer** and selecting the **Display Options** command. It can also be accessed from the **Display** menu or the **Display Options**  macro. The following table describes the display options available for the 2D Scatter Point module.

Display Option	Description
Active scatter point set	The name of the active scatter point set is listed at the top of the dialog. The symbol selected using the Scatter point symbols option (described below) applies to the active scatter point set. This makes it possible to use a different set of symbols for the points in each set so that the sets are easily distinguishable.
Scatter point symbols	<p>The Scatter point symbols item is used to display a symbol at the location of each scatter point. The widget to the left of the toggle is used to bring up a dialog listing the available symbols. The color of each of the scatter points in a set may be changed in this dialog also.</p> <p>The color of the scatter points can be adjusted according to the following options:</p> <ol style="list-style-type: none"> 1. Specified – uses the color specified next to the scatter point symbols 2. Data – the color ramp is used to assign a color to each of the symbols according to the value of the active scalar dataset
Contours	Individual scatter points can be colored based on the current dataset by using contour options .
Inactive scatter points	Individual scatter points can either be active or inactive . The Inactive scatter points option can be used to control the display of the inactive points.
Scatter point scalar values	The Scatter point scalar values option is used to display the value of the active data set next to each of the scatter points.
Scatter point labels	The Scatter point labels item is used to display the scatter point label next to each scatter point.
Scatter point numbers	The Scatter point IDs item is used to display the scatter point ID next to each scatter point.
Symbol legend	The Symbol legend item is used to display a symbol legend listing each of the scatter point sets by name and showing the symbol associated with the scatter point sets.

2D Scatter Point Tool Palette

The following tools are active in the dynamic portion of the [tool palette](#) whenever the [2D Scatter Point module](#) is active. Only one tool is active at any given time. The action that takes place when clicking in the [Graphics Window](#) with the cursor depends on the current tool. The list below describes the tools in the 2D scatter set tool palette.

Select Scatter Point

Used to select individual scatter points for editing using the Edit Window. Scatter points can also be dragged with the mouse. Scatter points can be deleted. With extremely large sets of scatter points, it may become difficult to identify a scatter point with a particular ID, even if the scatter point IDs are being displayed. In such cases, the **Find Point** command in the *Scatter Points* menu can be used to quickly locate a point. The command prompts for the ID of the desired point and the point is selected.

Select Scatter Point Set

Used to select entire scatter point sets for deletion or to designate the active scatter point set. When this tool is active, an icon appears at the centroid of the set for each of the scatter point sets. A scatter point set is selected by selecting the icon for the set.

Create Scatter Point

Used to interactively create scatter points by clicking in the GMS graphics window.

Related Topics

- [2D Scatter Point Module](#)

Interpolating with 2D Scatter Points

Scatter point sets are used for interpolation to other data types such as TINs, grids, and meshes.

Interpolation is useful for such tasks as contouring or setting up input data to a model. Since no interpolation scheme is superior in all cases, several [interpolation](#) techniques are provided in GMS.

The basic approach to performing an interpolation is to select an appropriate interpolation scheme and interpolation parameters, and then interpolate to the desired object using one of the [2D interpolation commands](#).

The interpolation options are selected using the [Interpolation Options](#) dialog accessed through the **Interpolation Options** command in the *Interpolation* menu. Once a set of options is selected, those options are used for all subsequent interpolation commands.

A 2D grid can be created which will enclose the scatter points by using the **Bounding 2D Grid** command in the *Scatter Points* menu. A 3D grid can also be created using the **Bounding 3D Grid** command in the *Scatter Points* menu.

Interpolation Method

The following 2D [interpolation methods](#) are supported by GMS:

- [Linear](#) – Uses data points that are first triangulated to form a network of triangles.
- [Inverse Distance Weighted](#) – Based on the assumption that the interpolating surface should be influenced most by the nearby points and less by the more distant points.
- [Clough-Tocher](#) – A finite element method because it has origins in the finite element method of numerical analysis.
- [Natural Neighbor](#) – Based on the Thiessen polygon network of the point data.
- [Kriging](#) – Based on the assumption that the parameter being interpolated can be

treated as a regionalized variable.

[Log interpolation](#) is also supported.

Related Topics

- [Interpolation](#)

Converting 2D Scatter Points to Other Types of Data

2D scatter points may be converted to other types of data used in GMS, such as a [TIN](#), [2D mesh nodes](#), or [observation points](#). 2D scatter points are converted by using the following commands in the *Scatter Points* menu:

Scatter Points → TIN

Creates a set of TIN vertices. These vertices are automatically triangulated to form a TIN.

Scatter Points → Mesh Nodes

Creates a set of 2D finite element nodes from the points in the active scatter point set. Requires triangulating the nodes to create the 2D mesh.

Scatter Points → Obs. Pts.

Creates one observation point for each of the scatter points in the active scatter point set. The active dataset values become the measured values for the observation points. Create a coverage with a measurement before executing this command.

Scatter Points → 3D Scatter Points

Creates a 3D scatter point set from the 2D scatter points. All of the datasets are copied to the 3D scatter points. The Z (elevation) of the 3D scatter points is set to the Z of the 2D scatter points at the time of conversion.

Scatter points can also be converted to either a 2D grid or 3D grid by using the bounding grid commands.

Bounding 2D Grid...

Creates a 2D grid that bounds or contains all of the scatter points in the active set. Will launch the [Create Finite Difference Grid](#) dialog which allows defining the grid dimensions.

Bounding 3D Grid...

Creates a 3D grid that bounds or contains all of the scatter points in the active set. Will launch the [Create Finite Difference Grid](#) dialog which allows defining the grid

dimensions.

Active/Inactive Points

Each scatter point has an active/inactive status. A scatter point with an inactive status can be displayed, but the [dataset](#) value at the point is ignored when interpolation takes place. As a result, interpolation proceeds as if the point did not exist.

The active/inactive flags for scatter points are particularly useful when dealing with transient data. For example, suppose that a set of scatter points represents TCE concentrations measured at a series of observation wells over a year's time. The locations of the wells and the measured concentrations can be imported to GMS as a scatter point set with a transient dataset. Once they are imported, the transient dataset can be interpolated to a grid and a film loop showing color shaded contours can be generated to illustrate how the plume has changed with time. However, in preparing the data for import, it is discovered that some of the data values are missing. One approach is to make up a dummy value for the missing sample and enter the entire dataset anyway. The problem with this approach is that it is difficult to determine an appropriate dummy value. Another option is to enter this value as a "non-detect". This causes the point to become inactive for the time step where the sample is missing. GMS disregards the point for that time step and performs the interpolation using the remaining active points.

Active/inactive flags are stored with datasets. If the active dataset is changed, the active/inactive flags will be reassigned based on the flags in the new active dataset. Not all datasets contain active/inactive flags. If a dataset does not contain flags, all points are assumed to be active.

The following methods can be used for controlling or assigning the active/inactive status of points:

Tabular Scatter Point Input

If the scatter points are imported using the [File Import Wizard](#) then a special data value can be designated as NONDETECT. This value is typically assigned to a number not likely to be encountered such as -999. Then, as the dataset columns are being read, any value with the

NONDETECT value is assumed to be inactive and the status flag is set accordingly.

Active/Inactive Flags Dialog

After a scatter point set has been imported to GMS, the active/inactive status flags for the active dataset can be edited by selecting the **Edit Inactive Flags** button in the [Dataset Info](#) dialog accessed from the *Dataset Properties* dialog (this dialog is accessed from the [Project Explorer](#)). This brings up the *Active/Inactive Flags* dialog. This dialog is used to either delete all of the current active/inactive flags (making all points active), or enter one or more key values (ex., -999) which are used to inactivate all points with the listed values.

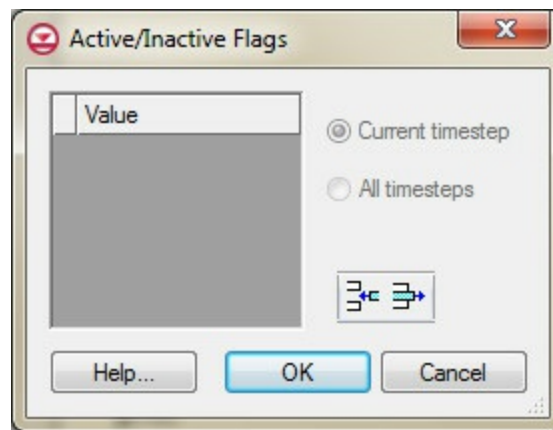

The Active/Inactive Flags dialog.

2D Interpolation Options

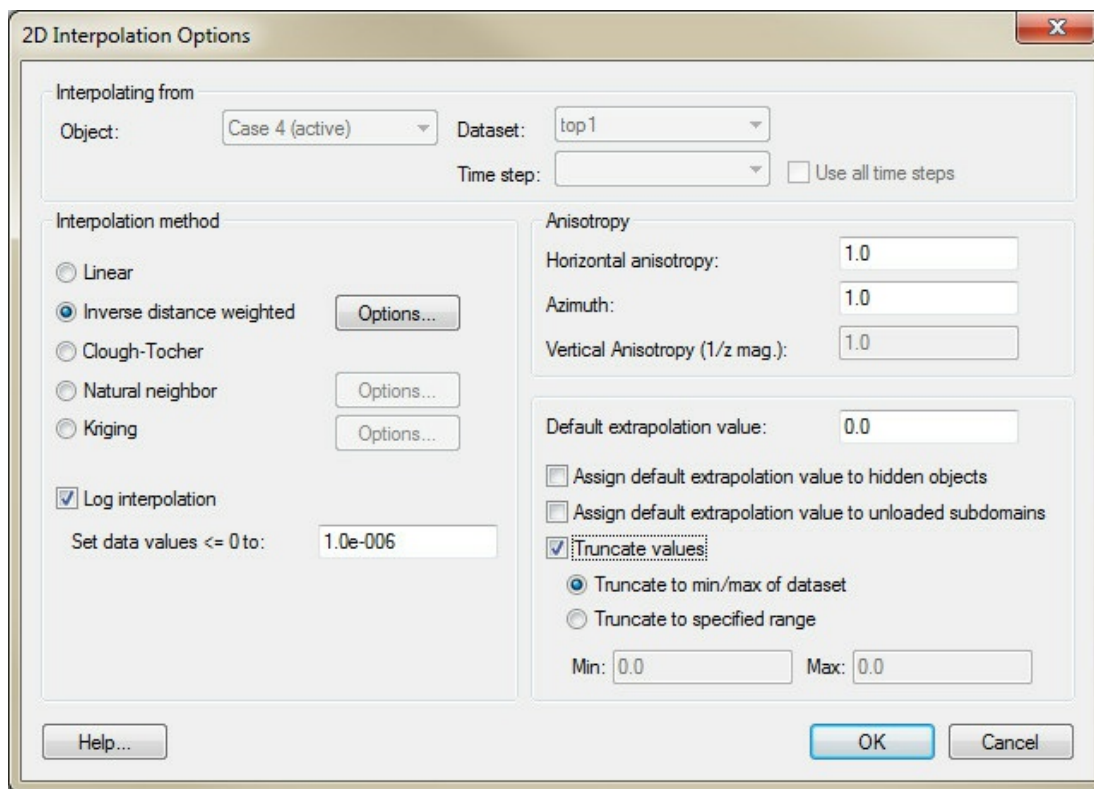

Example of the Interpolation Options dialog.

The [interpolation](#) options are selected using the *Interpolation Options* dialog accessed through the **Interp. Options** command in the *Interpolation* menu. Once a set of options is selected, those options are used for all subsequent interpolation commands. The items in the *2D Interpolation Options* dialog are as follows:

Active Dataset

Interpolation is always performed using the [active dataset](#) of the active scatter point set. The active dataset is normally selected in the [Project Explorer](#). The name of the current active dataset is listed at the top of the *2D Interpolation Options* dialog. The active dataset can not be changed with this dialog.

If the active dataset is transient then more interpolation options are available.

Steady State vs. Transient Interpolation

If the active dataset happens to be a transient dataset, two options are available:

1. Steady state interpolation can be performed using only the selected time step of the active dataset.
2. Transient interpolation can be performed using all of the time steps.

By default, only the selected time step is used. The time step is shown next to the dataset name at the top of the dialog. All of the time steps can be selected by selecting the *Use all time steps* option next to the *Time step* combo box. If all time steps are chosen, GMS begins with the first time step in the list and repeatedly interpolates from the scatter point set to the target object, one time step at a time, for all of the time steps. As a result, a dataset is created on the target object with a set of time steps matching the time steps on the scatter point set.

When performing transient interpolation with the [kriging](#) option, special care should be taken with regard to the variogram. Since each time step represents a separate set of data, technically, a separate variogram (or set of variograms) should be created for each time step (GMS stores a separate variogram for each step). This can be accomplished by selecting each time step one at a time using the *Time step* combo box at the top of the *Interpolation Options* dialog, and creating a new variogram for each time step.

Interpolation Method

The following 2D [interpolation methods](#) are supported by GMS:

- [Linear](#) – Uses data points that are first triangulated to form a network of triangles.
- [Inverse Distance Weighted](#) – Based on the assumption that the interpolating surface should be influenced most by the nearby points and less by the more distant points.
- [Clough-Tocher](#) – A finite element method because it has origins in the finite element method of numerical analysis.
- [Natural Neighbor](#) – Based on the Thiessen polygon network of the point data.

- **Kriging** – Based on the assumption that the parameter being interpolated can be treated as a regionalized variable.

Log interpolation is also supported.

Log Interpolation

When interpolating chemical data, it is not uncommon to have a small "hot spot" somewhere in the interior of the data where the measured concentrations are many orders of magnitude higher than the majority of the other concentrations. In such cases, the large values dominate the interpolation process and details and variations in the low concentration zones are obliterated. One approach to dealing with such situations is to use log interpolation. If this option is selected, GMS takes the log of each data value in the active scatter point set prior to performing interpolation. By interpolating the log of the dataset, small values are given more weight than otherwise. Once the interpolation is finished, GMS takes the anti-log (10^x) of the interpolated dataset values before assigning the dataset to the target grid or mesh.

Note that it is impossible to take the log of a zero or negative value. When the *log interpolation* option is turned on, a value must be entered to assign to scatter points where the current data value is less than or equal to zero. Typically, a small positive number should be used.

Anisotropy

Sometimes the data associated with a scatter point set will have directional tendencies. The *azimuth and horizontal anisotropy* allows taking into account these tendencies.

Extrapolation

Although they are referred to as interpolation schemes, most of the schemes supported by GMS perform both interpolation and extrapolation. That is, they can estimate a value at points both inside and outside the convex hull of the scatter point set. Obviously, the

interpolated values are more accurate than the extrapolated values. Nevertheless, it is often necessary to perform extrapolation. Some of the schemes, however, perform interpolation but cannot be used for extrapolation. These schemes include [Linear](#) and [Clough-Tocher](#) interpolation. Both of these schemes only interpolate within the convex hull of the scatter points. Interpolation points outside the convex hull are assigned the *Default extrapolation value*.

Truncation

When interpolating a set of values, it is sometimes useful to limit the interpolated values to lie between a minimum and maximum value. For example, when interpolating contaminant concentrations, a negative value of concentration is meaningless. However, many interpolation schemes will produce negative values even if all of the scatter points have positive data values. This occurs in areas where the trend in the data is toward a zero value. The interpolation may extend the trend beyond a zero value into the negative range. In such cases it is useful to limit the minimum interpolated value to zero. Interpolated values can be limited to a given range by selecting the *Truncate values* option in the *Interpolation Options* dialog. The range can be user-defined or automatically set to the maximum and minimum values of the dataset being interpolated.

Related Topics

- [3D Interpolation Options](#)

2D Scatter Point Commands

The *Scatter Point* menu becomes available when the 2D Scatter Point module is active. The menu has one submenu: the *Interpolation* submenu. Below are the commands available in this menu.

New Scatter Point Set

Creates a new dataset.

Lock All Scatter Points

Prevents adjusting the location of scatter points.

Scatter Point Settings...

Opens the Scatter sets tab under the [Preferences](#) dialog.

Find Point...

Locates a point based on ID number or text label.

[Interpolation](#) >

Interpolation Options...

Sets the interpolation options used when interpolating to other objects. The interpolation options are saved with the project.

Interpolate → Active TIN

Interpolate the active dataset on the active scatter set to the active TIN.

Interpolate → 2D Mesh

Interpolate the active dataset on the active scatter set to the 2D mesh.

Interpolate → 2D Grid

Interpolate the active dataset on the active scatter set to the 2D grid.

Interpolate → 3D Mesh

Interpolate the active dataset on the active scatter set to the 3D mesh.

Interpolate → 3D Grid

Interpolate the active dataset on the active scatter set to the 3D grid.

Interpolate → UGrid

Interpolate the active dataset on the active scatter set to the active UGrid.

Gaussian Simulation Options...

[Gaussian Sequential Simulation \(GSS\)](#) is a form of Kriging that can only be used for 2D interpolation and only works when interpolating to 3D cell-centered grids.

Run Gaussian Simulation

Launches the [Gaussian simulation run](#).

Jackknifing...

Interpolates the active scatter point set to itself using the currently selected interpolation scheme.

Summary...

Brings up the [Jackknifing Summary](#) dialog.

Bounding 2D Grid...

Creates a 2D Grid that bounds or contains all of the scatter points in the active set.

Bounding 3D Grid...

Creates a 3D Grid that bounds or contains all of the scatter points in the active set.

Scatter Points → Mesh Nodes

Creates nodes from the scatter points for a 2D mesh.

Scatter Points → Obs. Pts.

Creates Observation Points from the active dataset. A coverage that is set for observation data must already exist.

Merge Scatter Point Sets

Creates a merged scatter set from two or more scatter sets selected with the [Select Scatter Sets](#) tool.

Selected Scatter Point Right-Click Menu

In addition to the standard right-click menu commands, the following commands are available:

Activate

"Activates" selected scatter points by changing the active flags in the active dataset, or in all datasets. A dialog asks whether to change only the active dataset or all datasets. If the datasets are transient, all time steps will be changed.

Inactivate

Same as the **Activate** command but in reverse. Inactive points can be selected only if they are displayed via the option in the *Display Options* dialog.

Scatter Point Set Project Explorer Right-Click Menu

In addition to the standard right-click menu commands, the following commands are available:

Z Values → **Dataset**

Creates a dataset from the Z locations of the points.

Map to Z Values

Moves the Z locations of the points to the values in the dataset.

Zoom To Extents

Frames the Graphics Window around the selected objects.

Related Topics

- [2D Scatter Point Module](#)

5.7. 3D Mesh Module

3D Mesh Module

The 3D Mesh module is used to [create](#) and [edit](#) 3D finite element meshes. A 3D mesh consists of nodes, elements, and faces. A 3D mesh can be created from a 2D mesh, a 3D grid, 3D scatter points, or by using the automated meshing tools in GMS.

Once a mesh is constructed, the [FEMWATER](#) interface can be used to assign boundary conditions and analysis parameters and perform a FEMWATER analysis.

The module includes [tools](#) for manipulating 3D meshes as well as its own [menu commands](#) and [display options](#). 3D meshes can be [converted](#) into 2D meshes, 3D scatter points, Ugrids, or solids. The module also can [classify material zones](#) and use [isosurface](#) rendering.

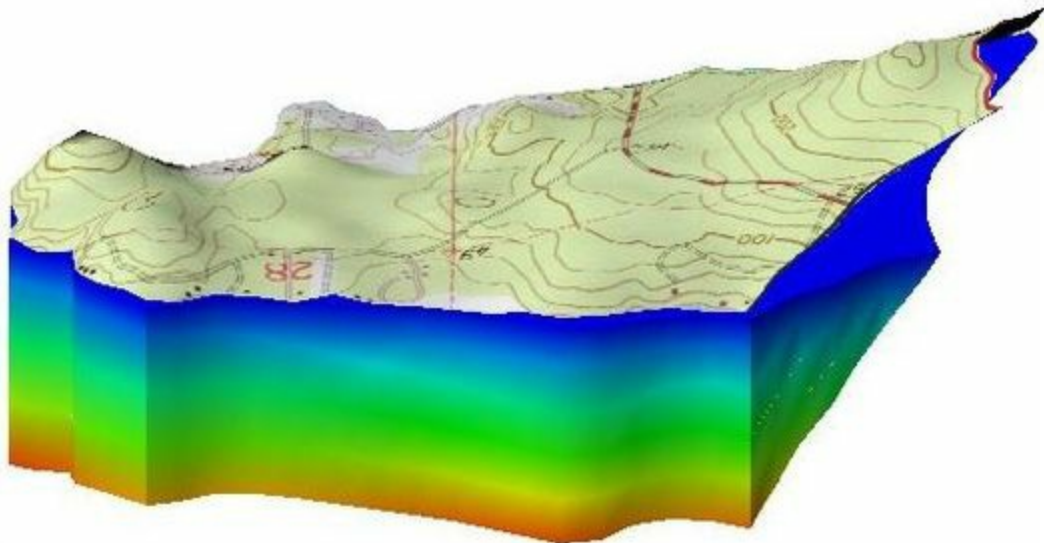

Isosurface of Pressure Head from a FEMWATER Simulation

Currently, only one 3D mesh can exist in a GMS project. GMS is able to work with large or complicated 3D finite element meshes.

The 3D Mesh module can be added to a [paid edition](#) of GMS.

3D Element Types

Four types of 3D elements are supported by GMS: eight node hexahedra, six node prisms or wedges, four node tetrahedra, and five node pyramids. Hexahedra and wedges are created by projecting a 2D mesh. Tetrahedral elements are constructed with the **Tessellate** command or they can be created elsewhere and imported into GMS.

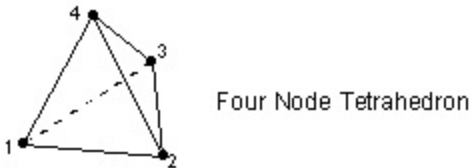
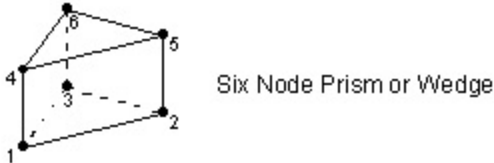
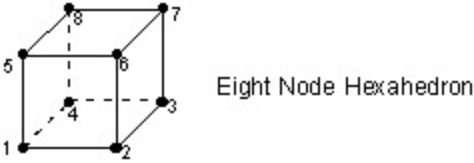

Types of 3D elements supported by GMS

Creating a 3D Mesh

In order to create a 3D mesh in GMS, there must be a set of 3D Mesh nodes. Elements can be created by using one of the [Create Element tools](#) and then selecting the mesh nodes to create elements. Duplicate points can be removed by selecting **Find Duplicates** command from the *Mesh* menu. If a node is found that is within a user specified tolerance of another node, the node is either selected or deleted.

3D Meshes can be created 2 different ways in GMS: converting a different GMS data type to a 3D mesh and using an automatic meshing technique.

Converting GMS data to a 3D Mesh

3D grids and 3D scatter points can be converted to a 3D mesh. This is accomplished by using the following commands:

Grid → 3D Mesh

A 3D grid can be converted into a 3D mesh. If the 3D grid is a mesh-centered grid, the grid nodes are simply converted into a mesh nodes. If the 3D grid is a cell-centered grid, a mesh node is placed at the centroid of each cell to form the 3D mesh. An eight node quadrilateral element is created from each cell in the grid.

Scatter Points → Mesh Nodes

The **Scatter Points → Mesh Nodes** command is used to convert each of the scatter points to a 3D mesh node. The nodes can then be used to generate a mesh using the **Tessellate** command in the *Mesh* menu in the 3D Mesh module.

Automated Meshing

3D finite element meshes are not always constructed within the 3D Mesh module. The following methods are available for the construction of 3D meshes:

Fill Between TINs → 3D Mesh

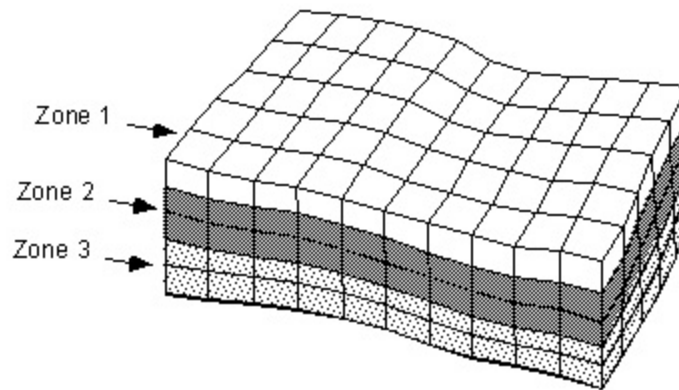

3D mesh with multiple zones

3D meshes are often constructed using a combination of tools in the [TIN module](#) and the [2D Mesh module](#). Portions of the mesh corresponding to "zones" or stratigraphic units are constructed one at a time as shown below. Each of these zones is bounded above and below by a surface and consists of one or more layers of 3D elements.

Before constructing a zone of elements, a 2D mesh must be created or imported using the 2D Mesh module. A pair of TINs must also be created which represent the top and the bottom of the zone. These TINs are typically constructed from borehole data or from scatter points. The zone is then created by selecting the two TINs and selecting the **Fill Between TINs → 3D Mesh** command in the *TINs* menu. At this point, the user is prompted to enter the number of layers of elements to be created between the TINs and the material that will be associated with the elements in the zone. Each of the elements in the 2D mesh is then "projected" through the two TINs to create a vertical column of 3D elements as shown below. For example, if N layers are specified, N 3D wedge elements are created from each of the triangular elements in the 2D mesh, and N 3D hexahedral elements are created from each of the quadrilateral elements in the 2D mesh. The Z coordinates of the nodes created for the 3D elements are distributed uniformly between the top and the bottom TINs.

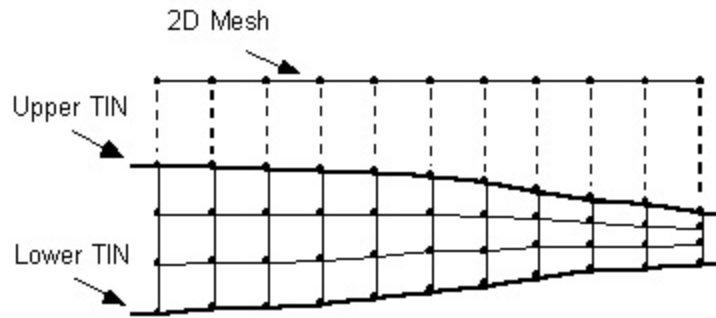

Projection technique for creating 3D meshes

This process is repeated for each of the zones in the mesh. In order for the nodes at the bottom of one zone to match the nodes at the top of another zone, the same TIN should be used at the bottom of the upper zone and at the top of the lower zone. If the vertices of the TIN are edited in any way after one layer is generated but before an adjacent layer is generated, a gap may be introduced between the two zones of 3D elements.

Classify Elements

One way to model features such as a clay seam is to create all of the layers in the mesh and then change the material type of selected elements. The **Classify Elements** command in the *Mesh* menu can be used to accomplish the same task using solid models of the soil stratigraphy. Using this command, a solid model can be constructed and used to change the material type of a set of elements corresponding to a complicated geometric feature. When the **Classify Elements** command is selected, the centroid of each element in the 3D mesh is computed and the centroid is checked with each of the solid models to determine which solid the centroid lies within. The material type of the element is then changed to correspond to the material type of the solid containing the element centroid. If the centroid of an element does not lie in the interior of any of the solids, the material type of the element is unaltered.

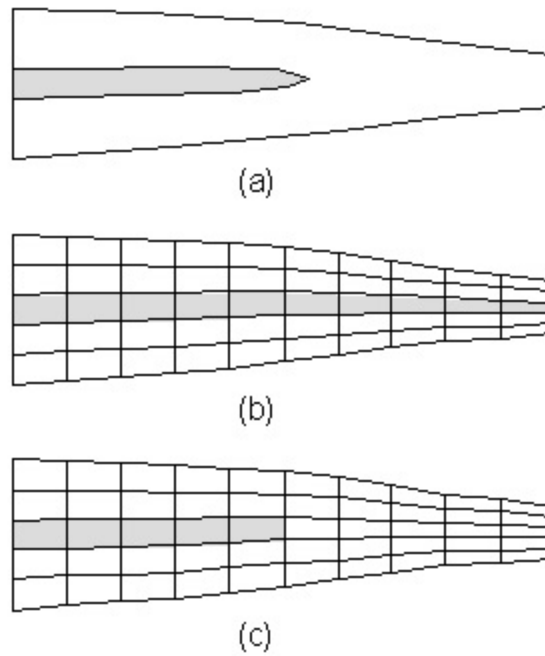

Modeling a clay seam using zones of elements

The advantage of this construction procedure for 3D meshes is that it is simple and it is fast. The disadvantage of the procedure is that truncations or pinchout zones in the stratigraphy are not directly modeled. However, such features can be simulated by selecting elements and changing the material type associated with the elements once a zone of elements has been created. For example, suppose an aquifer contains a clay lens that extends partially into the aquifer as shown in part a of the figure below. A zone of elements could be created for the clay layer which extends over the entire XY range of the model (part b). The elements in this set of clay elements that are not in the region actually occupied by the clay layer could be selected and assigned the material type of the aquifer (part c). This can also be accomplished with a Solid Model and the **Classify Elements** command.

Creating 3D Meshes From Solid Models

Unlike the *Solids* → *MODFLOW Boundary Matching* option, it is not necessary to create a 3D mesh before selecting the **Solids** → **Layered Mesh** command. The 3D mesh is automatically generated. Each element in the 2D projection mesh is extruded into a vertical column of cells and the solids are used to assign the elevations to the nodes. The material

ids are assigned to the 3D elements by finding the solid that encompasses the centroid of each 3D element assigning the material id of that solid to the element.

Creating 3D Meshes From Mesh Nodes

A mesh can be automatically constructed from a set of 3D nodes with the **Tessellate** command in the *Mesh* menu of the 3D Mesh module. This command performs the three-dimensional equivalent of the [Delauney triangulation](#) process. The Tessellation algorithm assumes that each of the vertices being tessellated is unique in xyz, i.e., no two points have the same xyz location. The result is a mesh composed entirely of tetrahedra. The region that is meshed corresponds to the convex hull of the nodes.

Editing a 3D Mesh

Editing Nodes

3D mesh nodes can be:

- **Moved** – The coordinates of a 3D mesh node can be edited by [selecting](#) the node and dragging it to its new location or by typing the new coordinates in the *Edit Window*.
- **Locked** – Once a mesh has been created and edited as desired, the locations of all of the mesh nodes can be locked using the **Lock All Nodes** command. This is generally done to avoid inadvertent movement of the nodes while assigning boundary conditions and manipulating the view. Once the nodes can be unlocked by unselecting **Lock All Nodes** command.
- **Deleted** – 3D mesh nodes can be deleted by selecting the node and then the **Delete** command from the *Edit* menu or the *Delete* key.
- **Renumbered** – As a 3D mesh is constructed within GMS, the nodes and elements in the mesh are numbered arbitrarily. If any nodes or elements are deleted, gaps are created in the numbering sequence. Such gaps can be removed and an optimal numbering sequence can be achieved by selecting the **Renumber** command in the *Mesh* menu. Prior to selecting the **Renumber** command, the user should select a series of boundary faces of the 3D mesh. These faces represent the location where the numbering process is to begin. In most cases, it is best to select all of the faces on an entire side of the mesh. This can be accomplished using the [Select Face](#) tool with the *Control* key held down. The renumbering process renumbers the nodes and elements in a logical order that tends to minimize the node and element bandwidth (which leads to more efficient solutions with some finite element solvers). The process begins by ordering the nodes and faces of the selected group of faces. This is essentially a 2D renumbering process. The longitudinal and lateral directions of the region of selected faces are determined and the numbering proceeds by sweeping along rows oriented in the lateral direction while progressing from row to row in the

longitudinal direction. Once the nodes and faces of the selected region are renumbered, the layer of elements adjacent to the faces are numbered in a similar sequence. This process is repeated by sweeping outward from the selected region, one layer of elements at a time, until the entire mesh is renumbered. The results of the renumbering process can be reviewed by turning on the display of node and/or element numbers in the *Display Options* dialog. The results can also be viewed by right-clicking on the 3D Mesh Data Folder in the *Project Explorer* and selecting the **Properties** command. The node and element bandwidths are listed in the dialog that comes up. If the objective of renumbering the mesh is minimizing the node and element bandwidths, the best results are generally achieved by selecting a side of the mesh corresponding to one of the two "ends" of the major or longitudinal axis of the mesh.

Refine Elements

3D mesh elements can be refined. Increasing the density of mesh elements can be accomplished by selecting a set of elements and selecting the **Refine Elements** command from the *Mesh* menu. This brings up the *Refine Elements* dialog.

Elements to Refine

The top portion of the dialog is used to specify which elements in the mesh are to be refined. If the *Refine all 3D mesh elements* option is selected, all elements in the mesh are refined regardless of which elements are selected. If the *Refine selected 3D mesh elements* option is selected, only the selected elements of the mesh are refined.

Even if the *Refine selected 3D mesh elements* option is selected, a few elements that were not selected must also be altered. This is due to the fact that the elements that were selected for refinement are refined, disjoint faces are created between the selected elements and the non-selected elements directly adjacent to the selected elements. To eliminate these disjoint faces, some transition elements are identified and refined. Transition elements are defined as any non selected element that shares at least one node with an element that is selected for refinement.

Refinement Method

There are three methods of refinement that can be used. The difference among the three methods is the shape of the resulting mesh elements. Each of the three methods is described below.

Vertical Column

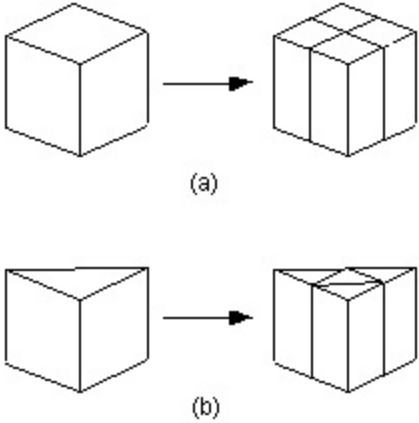

Vertical column refinement of (a) hexahedra and (b) wedges

Vertical column refinement is used to split hexahedra and wedges in the X and Y directions only, as shown on the right.

Vertical column refinement was designed to be used with meshes created by extruding a 2D mesh through several layers. Meshes created in this manner are composed strictly of hexahedra and wedges and can be made by following the mesh extrusion procedure.

Depending upon the type and orientation of the elements in a 3D mesh, vertical column refinement may not be possible. When the *Refine Elements options* is selected from the *Mesh* menu, the entire mesh is checked to see if it can be refined using vertical column refinement. If vertical column refinement is not possible, the *Vertical column refinement* option is dimmed. In order for vertical column refinement to be possible, the following conditions must be met.

1. If the entire mesh is to be refined, all elements in the mesh must be either hexahedra or wedges.
2. If only a selected portion of the mesh is to be refined, all selected elements must be

either hexahedra or wedges.

3. All wedges to be refined must be oriented in space such that their top and bottom faces correspond to the triangular faces of the wedge.
4. Both the top and bottom faces of each element to be refined must be on the boundary or adjacent to other elements that are also to be refined.
5. All transition elements (i.e., elements not intended to be refined but share at least one node with an element that was selected for refinement) must also satisfy conditions 2 and 3 above.

All Elements To Tetrahedra

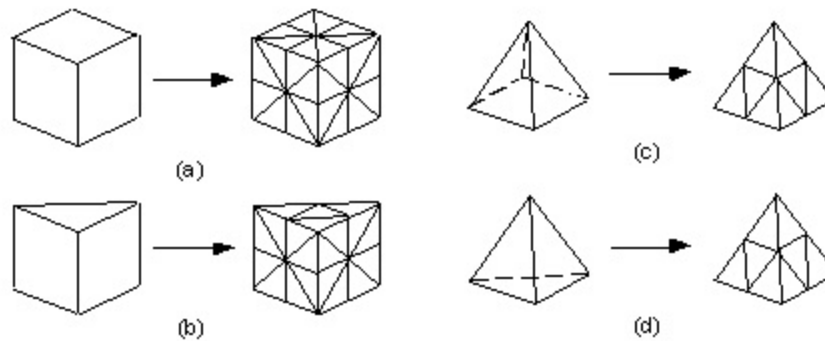

All elements to tetrahedra fine method of refinement of (a) hexahedra, (b) wedges, (c) pyramids, and (d) tetrahedra

All element types to tets refinement is used to convert any of the four basic element types to tetrahedra. This option is especially useful since some finite element solvers require meshes to be composed strictly of tetrahedra.

The *Coarse refinement* and *Fine refinement* options are used to specify the degree of refinement to be applied. If the *Fine refinement* option is selected, each tetrahedron is divided into eight smaller tetrahedra, each pyramid is divided into 16 smaller tetrahedra, each wedge is divided into 24 smaller tetrahedra, and each hexahedron is divided into 48 smaller tetrahedra. As with vertical column refinement, it is possible to refine either the entire mesh or selected portions of a mesh using the *Fine refinement* method.

If the *Coarse refinement* option is selected, each pyramid is divided into two smaller

tetrahedra, each wedge is divided into either three, or eight tetrahedra, and each hexahedra is divided into five, six, or twelve tetrahedra as shown below. Tetrahedra are not refined. Unlike the *Fine refinement* method, it is not possible to refine only a selected portion of a mesh when using the coarse method. The entire mesh gets refined.

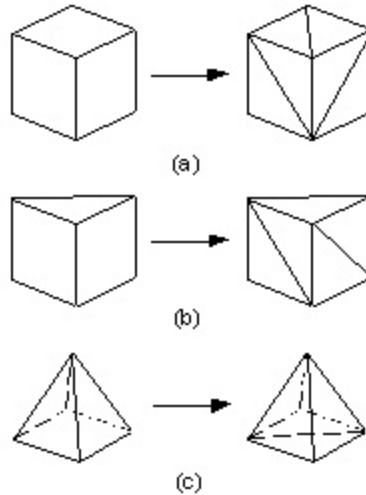

All elements to tetrahedra coarse method of refinement of (a) hexahedra, (b) wedges, and (c) pyramids

Retain Element Types

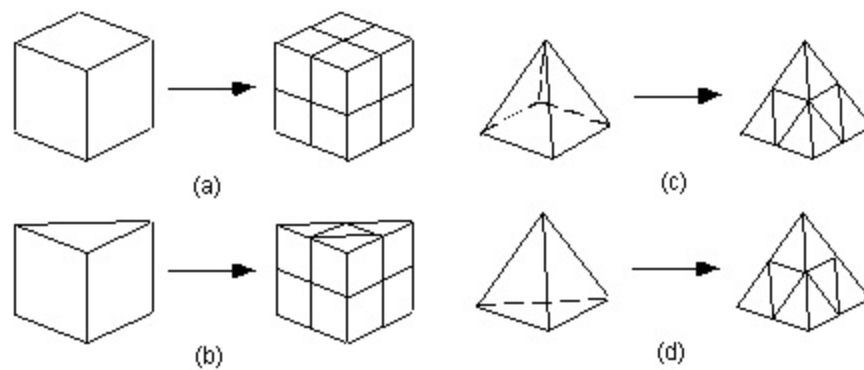



Retain element types refinement of (a) hexahedra, (b) wedges, (c) pyramids, and (d) tetrahedra.

Retain element types refinement is used to convert any of the four basic element types to smaller elements of the same type. For example, each hexahedra is divided into eight

smaller hexahedra as shown below. Pyramids are the exception since they are divided into five smaller pyramids and four tetrahedra. It is possible to divide a pyramid into four smaller pyramids, but the resulting pyramids are of poor quality.

Like *vertical column refinement*, it is possible to refine only selected portions of a mesh when using *Retain element types refinement*. However, it is not always possible to retain element types in the transition elements. If the original mesh is composed of strictly tetrahedra, any selected region of the mesh can be refined without introducing elements other than tetrahedra. However, if the mesh contains any element type other than tetrahedra, pyramids and wedges will be introduced into the transition region.

3D Mesh Display Options

The properties of all [3D mesh](#) data that GMS displays on the screen can be controlled through the *3D Mesh* tab of the [Display Options](#) dialog. This dialog is opened by right-clicking on the  3D Mesh Data entry in the [Project Explorer](#) and selecting the **Display Options** command. It can also be accessed from the *Display* menu or the  **Display Options** macro. The following table describes the display options available for the 3D Mesh module.



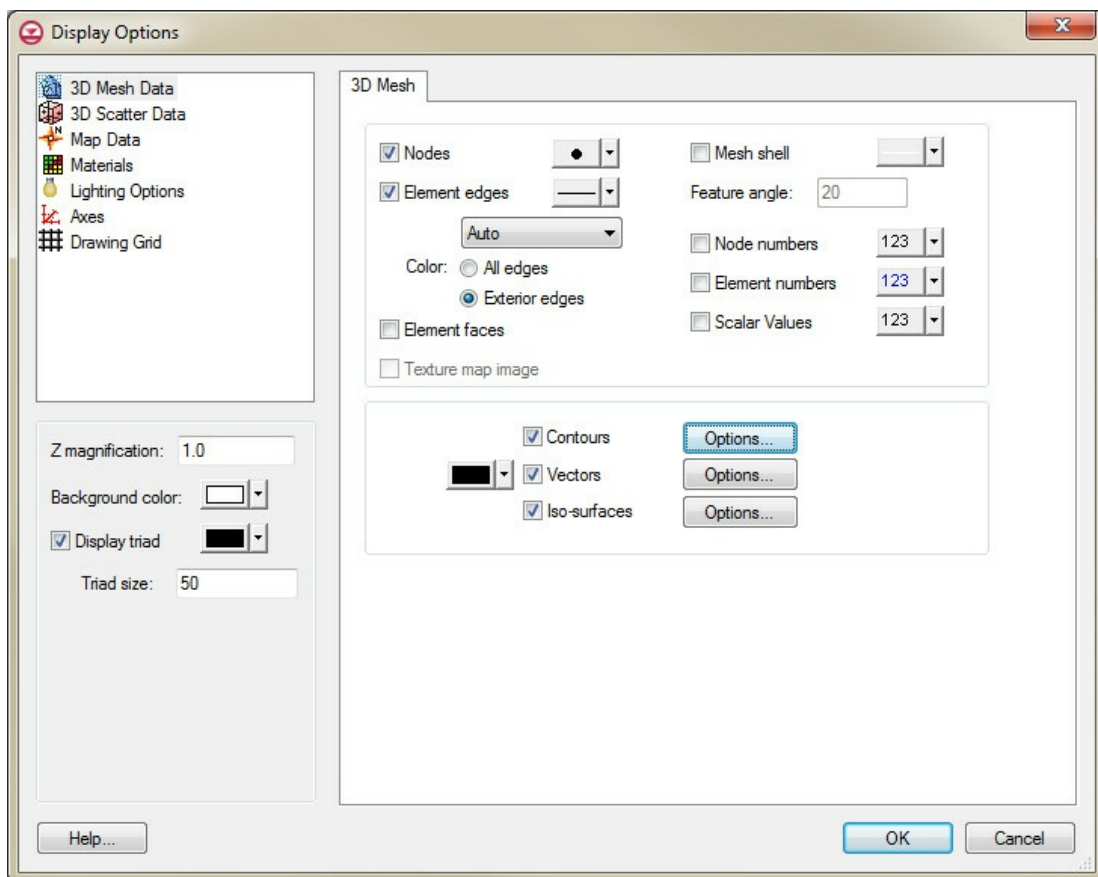

Display Option	Description
Nodes	The <i>Nodes</i> item is used to display the mesh nodes.
Element edges	<p>The <i>Elements</i> item is used to display the edges of elements. The elements are drawn using the color of the material associated with each cell. An option is included to display all of the edges or only the edges on the boundary of each material. Element can also be temporarily hidden.</p> <p>The color of the element edges can be adjusted according to the following options:</p> <ol style="list-style-type: none">1. Auto – draws the material color if faces are not displayed. Uses black or white if the faces are displayed.2. Specified – used the color specified next to the cell edges3. Material – displays the material color of the cell
Element faces	This option fills the elements with the material color.
Texture map image	The <i>Texture Map Image</i> item is used to "drape" an image over the top surface of the 3D Mesh.
Mesh shell	The <i>Mesh shell</i> item displays an edge for each of the edges on the exterior of the set of all elements (visible or invisible) which corresponds to a discontinuity in the mesh exterior. This display option provides a helpful spatial context when displaying isosurfaces or cross sections.
Feature angle	The mesh shell <i>feature angle</i> is used only when the <i>Mesh Shell</i> option is selected. This angle represents a threshold angle at which an edge of the shell will be displayed. If for example, an angle of 45 degrees is defined, any edge of the mesh which divides two element faces that are at an angle greater than 45 degrees to each other will not be displayed.
Node numbers	The <i>Node numbers</i> item displays the ID associated with each node next to the node. The numbers are only displayed on the front-facing faces of exterior elements.
Element numbers	The <i>Element numbers</i> item displays the ID associated with each element at the centroid of the element. The numbers are only displayed on the front-facing faces of exterior elements.
Scalar values	The <i>Scalar Values</i> item displays the scalar values of the active dataset for each node next to the node.
Contours	Most of the objects supported by GMS can be contoured by turning on the Contour Options in the <i>Display Options</i> dialog. When an object is contoured, the values associated with the active dataset for the object are used to generate the contours.
Vectors	If the Vectors item in the <i>Display Options</i> dialog is selected for an object (TIN, grid, or mesh), vector plots can be generated using the active vector dataset for the object. One vector is placed at each node, cell, or vertex.
Isosurfaces	If the Isosurfaces item in the <i>Display Options</i> dialog is selected for an object (3D grid or 3D mesh), isosurfaces will be generated. An isosurface is the 3D equivalent of a contour line. While a contour line is a line of constant value extracted from a surface, an isosurface is a surface of constant value extracted from a 3D dataset.



The Display Options dialog showing the 3D Mesh tab.

3D Mesh Tool Palette

The following tools are contained in the dynamic portion of the [tool palette](#) when the [3D Mesh module](#) is active. Only one tool is active at any given time. The action that takes place when the user clicks in the [Graphics Window](#) depends on the current tool. The following table describes the tools in the 3D Mesh tool palette.

Tool	Tool Name	Description
	Select Boundary Nodes	<p>The Select Boundary Nodes tool is similar in function to the Select Nodes tool except that it selects only nodes that are on the boundary of the mesh. This tool is useful when assigning nodal boundary conditions.</p> <p>All of the standard multi-selection techniques are available with this tool. In addition, if the <i>Control</i> key is depressed when a selection is made, all nodes on the same "side" of the mesh as the selected node are automatically selected. This option is useful when the same boundary condition is to be assigned to all nodes on the selected mesh side. The extent of the selected "side" is determined by feature breaks on the exterior of the mesh. If the angle between two adjacent element faces on the mesh is sharp, the common edge of the faces is assumed to be a feature break and is the boundary of a mesh side.</p>
	Select Boundary Faces	<p>The Select Boundary Faces tool is similar in function to the Select Boundary Nodes tool except that it selects faces of elements on the boundary of the mesh. This tool is useful when assigning flux type boundary conditions.</p> <p>All of the standard multi-selection techniques are available with this tool. In addition, if the <i>Control</i> key is depressed when a selection is made, all element faces on the same "side" of the mesh as the selected face are automatically selected. This option is useful when the same boundary condition is to be assigned to all faces on the selected mesh side. The extent of the selected "side" is determined by feature breaks on the exterior of the mesh. If the angle between two adjacent element faces on the mesh is sharp, the common edge of the faces is assumed to be a feature break and is the boundary of a mesh side.</p>
	Select Material Zones	<p>The Select Material Zones tool is used to select all elements of the mesh that have the same material type. This tool is useful for hiding or isolating zones in the mesh corresponding to a material type. When this tool is active, an icon appears on the mesh display for each of the material types. A material zone is selected by selecting the icon.</p>
	Select Elements	<p>The Select Elements tool is used to select individual elements. Elements are typically selected for hiding, or for changing the material type associated with the element. Multi-selection can be performed by holding down the <i>Shift</i> key while selecting or by dragging a rectangle to enclose the elements to be selected. The ID of the selected element is displayed in the Edit Window.</p> <p>Only visible elements can be selected. Elements which have been hidden cannot be selected. Hidden elements can be made visible by selecting the Show command in the Display menu. When selecting elements by dragging a box, all elements that lie within the box are selected. When selecting elements by clicking on individual elements with the cursor, only elements on the exterior of the visible portion of the mesh are selected. Elements in the interior of the mesh can be selected individually by first hiding the elements surrounding the elements to be selected. An element can also be selected by using the Find Element command in the Mesh menu user is prompted for an element ID and the element is selected. Any previously selected elements are unselected.</p>
	Select Nodes	<p>The Select Nodes tool is used to select individual nodes for editing. Multi-selection can be performed by holding down the <i>Shift</i> key while selecting or by dragging a rectangle to enclose the nodes to be selected.</p> <p>The ID of the selected node is displayed in the Edit Window. The coordinates of the selected node are also displayed in the Edit Window and can be edited by typing in new coordinates and selecting the TAB</p>

or Return key. Nodal coordinates can also be edited by dragging a node using the Select Nodes tool. When in plan view, nodes can be dragged in the XY plane. In any other view, nodes are constrained to move along the Z axis when they are being dragged. Since it is possible to accidentally drag points, nodes can be "locked" to prevent them from being dragged by selecting the **Lock All Nodes** command from the *Mesh* menu. The nodes can be unlocked by selecting **Unlock All Nodes** from the *Mesh* menu. A node can also be selected by using the **Find Node** command in the *Mesh* menu. The user is prompted for a node ID and the node is selected. Any previously selected nodes are unselected.

 **Select Node Strings** The **Select Node Strings** tool is used to select one or more strings of nodes. Node strings are used for operations such as adding breaklines to the mesh.

The procedure for selecting node strings is somewhat different than the normal selection procedure. Strings are selected as follows:

- Click on the starting node for the string. The node selected will be highlighted in red.
- Click on any subsequent nodes to add to the string (nodes do not have to be adjacent). The selected nodes are now connected by a solid red line.

To remove the last node from a string, press the Backspace key. To abort entering a node string, press the ESC key. To end a node string, press Return or double-click on the last node in the string. Another node string can then be selected.

 **Select Wells** The **Select Wells** tool is used to select nodes which have a well (point source/sink) type boundary condition assigned to them. Since wells are often assigned to nodes in the interior of the mesh, it may be difficult to select the node that a well has been assigned to using the **Select Nodes** tool due to the large number of nodes in a mesh. This tool makes this type of selection easier since only well nodes can be selected when the tool is active.

 **Select Cross Sections** Once a set of cross sections has been created, they can be selected using the **Select Cross Sections** tool. Selected cross sections can be deleted, or they can be made visible or invisible using the **Hide** and **Show** commands.

When this tool is active, a cross section icon appears on each cross section. A cross section is selected by selecting the icon. When a different tool is selected, the icons disappear. When there are several cross sections, it is often easier to differentiate cross section icons in plan view (assuming the cross sections were created in plan view). As a general rule the icons are placed in the center of the first line segment used to cut the cross section.

 **Select Particle Starting Locations** Particle starting locations, used in particle tracking, can be selected with the **Select Particle Starting Locations** tool. Selected particles can be deleted. Statistical information for the selected particles, such as the path length and time, is displayed in the status bar.

 **Create Cross Section** Cross sections can be created from a 3D mesh using the **Make Cross Section** tool. Cross sections are formed when the user enters a polyline. A polyline is entered by clicking on several points and double-clicking on the final point when the line is finished. The *Delete* or *Backspace* key may be used to remove a point from the polyline, and the *ESC* key can be used to abort the process. A cross section or fence diagram is then computed by cutting perpendicular to the current viewing orientation through the currently visible elements of the mesh. While most cross sections are created with the mesh in plan view, any viewing orientation can be specified.

Once cross sections are created, they can be deleted, hidden, or shown using the Select Cross Sections tool. Datasets are automatically interpolated from the 3D mesh to the cross sections for generation of contour and color fringe plots.

 **Define Tetrahedron** Four tools are provided for interactively creating the four types of elements supported in GMS. While it is not practical to create an entire mesh with these tools, they are often useful for editing an existing mesh.

 **Define Pyramid Element** The following steps are taken to construct individual elements:

- Click on the first node. The node will be highlighted in red.

 **Define Wedge Element**

- Click on the remaining nodes, one at a time, in the [standard order](#) for the element type.

If the wrong node is selected, hitting the *Delete* or *Backspace* key backs the process up by one node. Hitting the *ESCAPE* key aborts the entire process.



**Define
Hexahedron
Element**

Isosurfaces

Isosurface rendering is a powerful tool for visualizing 3D datasets. Isosurfaces can be generated for 3D grids and 3D meshes. An isosurface is the 3D equivalent of a contour line. While a contour line is a line of constant value extracted from a surface, an isosurface is a surface of constant value extracted from a 3D dataset.

Defining Isovalues

Isosurfaces are computed using the active scalar dataset for the grid or mesh. The *Isosurface Options* dialog is accessed through the **Isosurface Options** command in the *Data* menu or through a button in the *3D Grid Display Options* or *3D Mesh Display Options* dialogs. The items in the *Isosurface Options* dialog are as follows:

Active Dataset

At the top of the dialog the active scalar dataset and active time step is listed. The maximum and minimum dataset values are also listed.

Isovalues

In the next section of the dialog the number of isosurfaces and the isovalues are defined. A maximum of 12 isosurfaces may be created. The **Default** button can be used to automatically set up a number of isovalues. For example, if the number of isosurfaces is three and the button is selected, three isovalues, equally spaced between the maximum and minimum dataset values are generated.

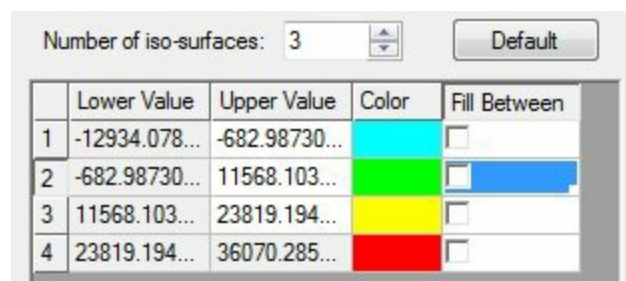

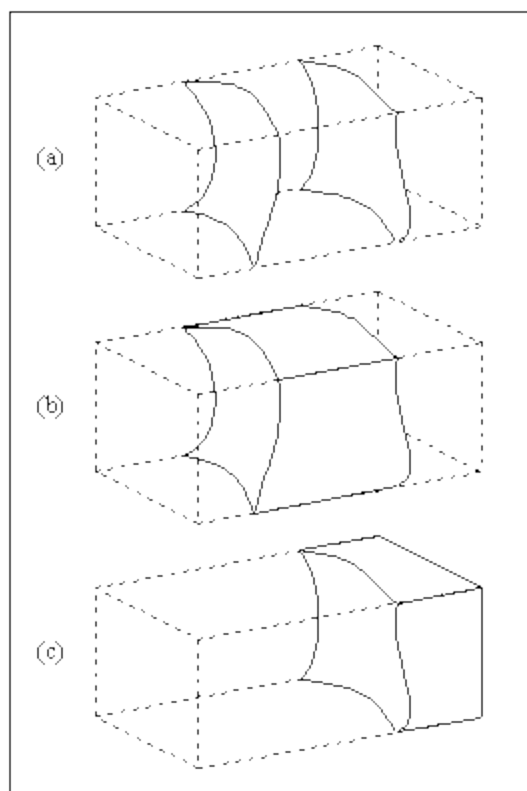

Fill Between

The *Fill Between* boxes to the right of the isovalues are used to generate surfaces on the exterior of the mesh or grid between two isovalues. For example, in part (a) of the figure shown below, two isosurfaces have been generated using two isovalues. The image shown in part (b) was computed using the same isovalues and with the *Fill Between* box checked similar to figure (d) below. This causes the region of the mesh or grid boundary between the two isovalues to be defined as surfaces. The image shown in part (c) was generated using a single isovalue with the *Fill Between* box checked on the line after the isovalue like figure (e). This causes the boundary with dataset values greater than the specified value to be defined as surfaces.





Isosurfaces (a) No fill; (b) Fill between two isovalues; (c) Fill above or below an isovalue

Number of iso-surfaces: 2

	Lower Value	Upper Value	Color	Fill Between
1	-12934.078...	3400.7096...		<input type="checkbox"/>
2	3400.7096...	19735.497...		<input checked="" type="checkbox"/>
3	19735.497...	36070.285...		<input type="checkbox"/>

(d) *Filling between 2 isosurfaces*

Number of iso-surfaces: 1

	Lower Value	Upper Value	Color	Fill Between
1	-12934.078...	11568.103...		<input type="checkbox"/>
2	11568.103...	36070.285...		<input checked="" type="checkbox"/>

(e) *Filling above an isosurface*

Transparency

Transparency can be specified for each Isosurface. Transparency affects the display of isosurface faces.

Define as Cross-Section

Like contour lines, isosurfaces are temporary in nature. In other words, if the active dataset is changed, the current isosurfaces are deleted and new isosurfaces are computed using the new dataset values. In some cases, it is useful to create an isosurface as a permanent object. This can be accomplished by selecting the *Define as cross section* option in the *Isosurface Options* dialog. This causes the computed isosurfaces to be treated as cross sections. As cross sections, these isosurfaces can be saved to a file, hidden, or deleted. In addition, if a new dataset is selected, the isosurfaces are not deleted. In fact, the values associated with the new dataset are interpolated to the cross section isosurfaces and can be displayed on the isosurfaces as color fringes or contours. This makes it possible to effectively display two datasets at once.

Interior Edge Removal

By default, whenever an isosurface is computed from a mesh or a grid, the lines corresponding to the intersection of the isosurface with the cell or element boundaries are displayed on the isosurfaces. If the *Interior edge removal* option is selected, only the edges on the isosurface corresponding to a feature angle break greater than the specified value are displayed on the isosurface. For example, if the feature angle were set at 30.00 degrees, the angle formed by the two polygonal faces adjacent to each edge in the isosurface would be checked and only those edges where the computed angle is less than $180 - 30 = 150$ degrees would be displayed. Typically, a small value (e.g., 0.001) is used so that only the edges adjacent to two coplanar faces are removed (made invisible).

Visible Region Only Option

If the *Compute for visible region only* option is chosen, the isosurfaces are not computed in regions where the cells or elements are not visible. Otherwise, isosurfaces are computed for all regions of the mesh or grid.

Isosurface Edges

If this option is on, the lines that make up the isosurface are displayed.

Isosurface Faces

If this option is on, the isosurface is displayed a color-filled surface.

Specify Range

The *specified range* command allows controlling the minimum and maximum value used to define the colors assigned to the isosurfaces.

Isosurface Volumes

The volume within an isosurface or the volume between two isosurfaces is computed using the **Isosurface Volume** command in the *Grid* menu. This command brings up a dialog with a list of isovalues and volumes. The listed isovalues correspond to the isovalues defined in the *Isosurface Options* dialog. The listed volumes represent the volumes between each of the isovalues. For example, the first volume represents the volume below (on the "low" side

of) the lowest isovalue, the second volume represents the volume between the first and second isovalues, etc. The total volume listed at the bottom of the dialog should correspond to the total volume of the grid or mesh.

Beginning with GMS 7.0 the *Isosurface Volumes* dialog has changed to display a single volume associated with each isosurface. In addition to showing a single volume, it is also possible to view the volume of the cells (or elements) that are less than the isovalue, the volume of the cells that are greater than the isovalue, and the volume of the cells intersected by the isosurface by turning on the *Display additional volume information* toggle. In some cases GMS is unable to compute the volume of the isosurface. In those cases there is still an estimate of the isosurface volume by looking at the volume of the cells. The volume of the cells should be close to the volume of the isosurface when the grid (or mesh) is composed of very "small" cells. The difference between the isosurface volume and the volume of the cells decreases as the size of the cells decreases.

See also

- [Datasets](#)

Converting 3D Meshes to Other Data Types

3D Mesh Nodes can be converted to 3D Scatter Points by using the following command in the *Mesh* Menu:

Mesh to 3D Scatter Points

The **Mesh** → **Scatter Points** command in the *Mesh* menu is used to create a new scatter point set using the nodes in a mesh. A copy is made of each of the datasets associated with the mesh and the datasets are associated with the new scatter point set.

This command is useful for comparing the solutions from two separate simulations from different meshes. For example, if two simulations have been performed with slightly different meshes (base vs. plan) it may be useful to generate isosurfaces or a fringe plot showing the difference between the solutions. It is possible to generate a dataset representing the difference between two datasets using the data calculator. However, the two datasets must be associated with the same mesh before the data calculator can be used. The datasets from one of the meshes can be transferred to the other mesh as follows:

1. Load the first mesh and its dataset into memory.
2. Convert the mesh to a scatter point set using the **Mesh** → **Scatter Points** command.
3. Delete the first mesh by selecting the **Delete All** command from the *Edit* menu.
4. Load the second mesh and its dataset into memory.
5. Switch to the 3D Scatter Point module and select an interpolation scheme using the **Interpolation Options** command in the *Interpolation* menu.
6. Interpolate the dataset to the second mesh by selecting the **3D Mesh** command from the *Interpolation* menu.

At this point, both datasets will be associated with the second mesh and the *Data Calculator* can be used to compute the difference between the two datasets. This same sequence of steps can be used to interpolate a dataset from a 3D grid to a 3D mesh, or vice versa.

3D Mesh to 2D Mesh

This command creates a 2D mesh from the upward facing elements of the 3D mesh. The materials of the 3D elements are preserved on the 2D mesh. The datasets associated with the 3D mesh are NOT transferred to the 2D mesh.

Mesh to Solids

This command will convert each material zone in the 3D Mesh to a solid.

Building the 3D Mesh from the FEMWATER Conceptual Model

Once the FEMWATER conceptual model is constructed, the next step is to use the conceptual model to build a 3D finite element mesh. This is accomplished by first building a 2D mesh, then building the 3D mesh by extruding each of the 2D elements in 3D elements.

Map → 2D Mesh

The first step in building the 3D mesh is to select the **Map → 2D Mesh** command in the *Feature Objects* menu. This command creates a 2D mesh by automatically filling in the interior of the conceptual model with nodes and elements. The size and spacing of the elements is controlled by the spacing of the vertices on the arcs and by the refine point attribute assigned to any wells in the interior of the conceptual model.

An example of the **Map → 2D Mesh** command is shown in the following figure. A sample FEMWATER conceptual model is shown in part a. The 2D mesh resulting from execution of the **Map → 2D Mesh** command is shown in part b.

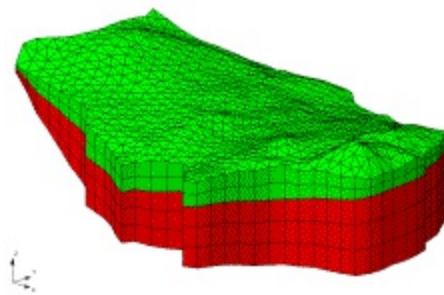

*Converting a FEMWATER conceptual model (a) conceptual model (b) 2D mesh created with **Map → 2D Mesh** command (c) 3D mesh created by extruding 2D mesh (d) 3D mesh after **Map → FEMWATER'** command.*

Creating the 3D Elements

Once the 2D mesh is created, the next step is to create the 3D mesh by extruding each of

the 2D elements into a series of 3D elements. The elevations of the 3D elements can be defined from a set of boreholes, a set of TINs, or a set of Solids.

For sites with relatively simple stratigraphy, the **Regions → 3D Mesh** command in the Borehole module can be used.

For sites with more complex stratigraphy, the Fill Between **TINs → 3D Mesh** command in the TIN module should be used.

A mesh can also be created using the **Solids → Layered Mesh** command in the Solid module.

3D Mesh Commands

The *Mesh* menu is available when the 3D Mesh module is active. The menu has one submenu: the *Convert To* submenu. The menu contains the following commands:

New 3D Mesh

Creates a new, empty 3D mesh.

Lock All Nodes

Since it is possible to accidentally drag points, nodes can be "locked" to prevent them from being dragged or edited by toggling on this command.

Find Duplicate Nodes...

Selects nodes that are close to each other within a user specified tolerance.

Find Element...

Selects an element given the element ID.

Find Node...

Selects a node given the node ID.

Tessellate

3D equivalent of Delauney triangulation. Creates a 3D tet mesh from mesh nodes.

Renumber

Renumbers mesh nodes eliminating gaps in numbering. Optionally a node string can be created and used to guide the renumbering.

Repack Nodes...

Refine Elements...

Subdivides elements into smaller elements.

Classify Elements

Element materials are assigned based on the solid the element centroid is within.

Isosurface Options...

Brings up the *Isosurface Options* dialog.

Isosurface Volumes...

Brings up the *Isosurface Volumes* dialog.

Zoom To Extents

Frames the Graphics Window around the selected objects.

Convert To >

Mesh → 3D Scatter Points

A new 3D scatter point set is created from the 3D mesh nodes.

3D Mesh → 2D Mesh

Creates a 2D mesh from the upward facing elements of the 3D mesh.

3D Mesh → Solids

Creates solids from each material zone of the 3D mesh.

New Material Set

Creates a new material set in the Project Explorer.

Export

Exports a 3D mesh to a file (*.3dm, *.fem etc).

Related Topics

- [3D Mesh Module](#)
- [Converting 3D Meshes to Other Data Types](#)

5.8. 3D Grid Module

3D Grid Module

The 3D Grid module is used to create 3D Cartesian grids. These grids can be used for [interpolation](#), [isosurface](#) rendering, [cross sections](#), and finite difference modeling.

Interfaces to the following 3D finite difference models are provided in this module:

- [MODFLOW](#)
- [MODPATH](#)
- [MT3DMS](#)
- [RT3D](#)
- [SEAM3D](#)

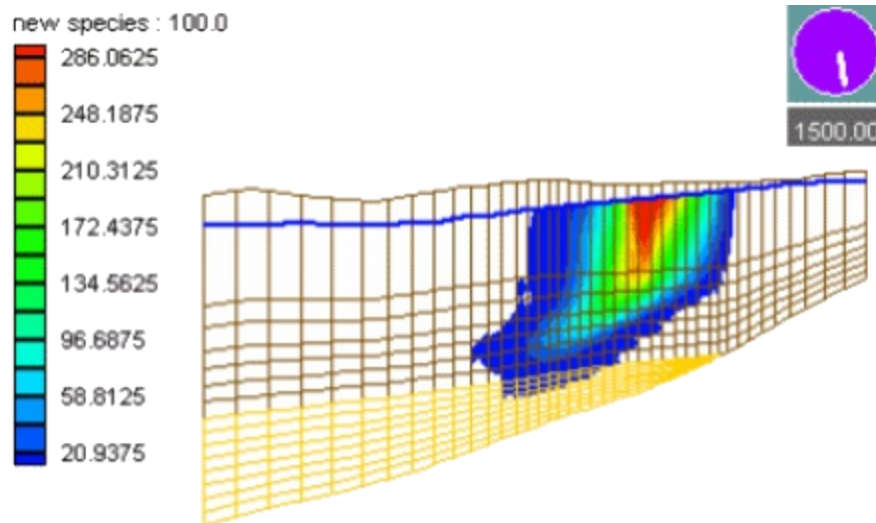

Sample MT3D Simulation

The 3D Grid tools are included with all [editions](#) of GMS, including the community version.

3D Grid Types

Two types of 3D grids are supported in GMS: cell centered and mesh centered. When computations are performed on a mesh-centered grid, the computation points are the grid nodes or the corners of the grid cells. With a cell-centered grid, computations are performed at the cell centers. The display options, however, shows both cell- and mesh-centered grids as having the node dots on the corners of the cells.

When a dataset is imported to a cell-centered grid, there is one value in the dataset for each cell. To use contouring or fringing the values at the cell corners must be known. Therefore, whenever contouring or fringing is performed, the values at the cell centers are interpolated to the cell corners. Interpolation to cell corners is only done for visualization. All computations performed using the [Data Calculator](#) are performed on the original values at the cell centers. With mesh-centered grids, all visualization and computations are performed at the cell corners and no interpolation is necessary.

All of the model interfaces in the 3D Grid module are based on cell-centered grids. Mesh-centered grids are useful for interpolation and isosurface visualization since no extra interpolation is necessary.

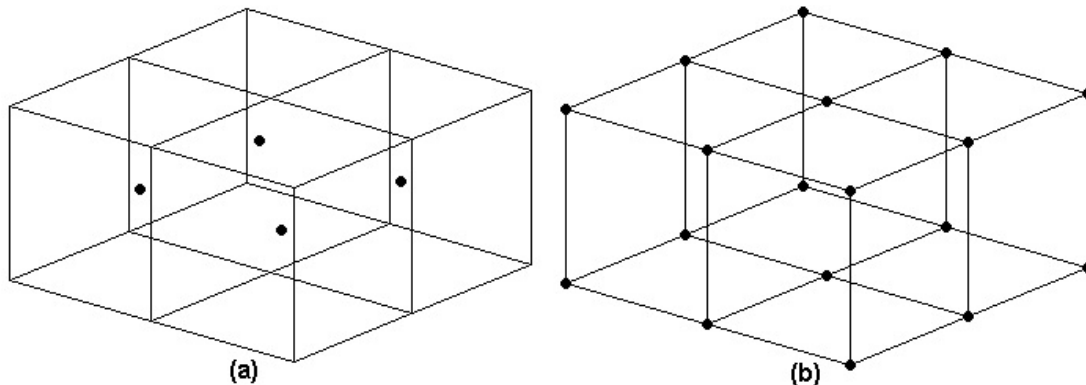

(a) Cell Centered Grid (b) Mesh Centered Grid

Creating and Editing 3D Grids

GMS provides two methods for creating 3D grids and multiple ways to edit a 3D grid.

Creating 3D Grids

Two techniques are available for creating 3D grids: the **Create Grid** command in the 3D Grid Module and the **Map** → **3D Grid** command in the Map Module. When a 3D Cell Centered Grid is created two different viewing modes are available.

Create Grid

A new grid can be created by selecting the **Create Grid** command from the *Grid* menu. This command brings up the *Create Grid* dialog. The options in the dialog are as follows:

- **Origin, Length, Rotation** – By default, the rows and columns of [2D grids](#) are aligned with the x and y axes. However, grids can be rotated about the z-axis, if desired. Thus, the information needed to determine the overall size and location of the grid is the xy coordinates of the lower left corner of the grid (the lower left corner prior to rotation), the length of the grid in the x and y directions, and the rotation angle. The xy coordinates of the origin are entered in the Origin edit fields, the dimensions are entered in the Length fields, and the angle of rotation is entered in the field entitled Rotation about Z-axis.
- **Bias** – Several options are available for defining the number and locations of the cell boundaries. A bias can be defined which controls how the cell size varies from one cell to the next. For example, an X bias of 1.5 causes each cell to be 50% larger than the previous cell when moving in the positive x direction.
- **Number of Cells** – The total number of cells in each direction (number of rows or columns) can be defined by explicitly entering a number or by entering a base cell size and a limit cell size. The base and limit cell size options are used when a bias other

than 1.0 is specified. The base cell size is the size of the first cell in the sequence. The cells are then generated by altering the cell size according to the bias until the limit cell size is reached. The remainder of the cells are constructed using the limit cell size.

- **Type and Orientation** – The controls at the bottom of the *Create Grid* dialog are used to define the type and orientation of the grid. The user can specify whether the grid should be a mesh-centered grid or a cell-centered grid. The orientation of the ij axes with respect to the XY axes can also be specified.

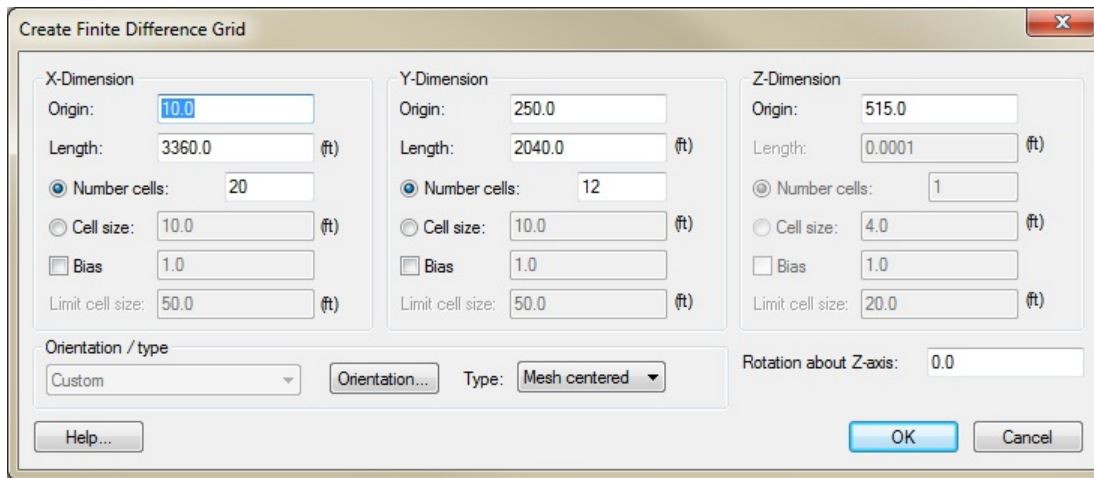

The Create Finite Difference Grid dialog

Map → 3D Grid

Once the feature object coverages defining a conceptual model have been completely defined, the conceptual model is ready to be converted to a numerical model. The first step in this conversion process is to create a grid using the **Map → 3D Grid** command. Typically, the **Grid Frame** command is used prior to this command to define the location and dimensions of the grid.

When the **Map → 3D Grid** command is selected, the *Create Grid* dialog appears. If a grid frame has been defined, the size and location of the grid frame are used to initialize the fields in the *Create Grid* dialog. In most cases, these values will not need to be changed and the user can simply select the **OK** button to create the grid. If a grid frame has not been defined, the size and location of the grid are initialized so that the grid just surrounds the currently defined conceptual model. Once again, in most cases,

no changes will need to be made and the user can typically immediately select the **OK** button to create the grid.



If one or more refine points are defined in the conceptual model (available when "Refinement" is selected in the [Coverage Setup](#) dialog), the number of rows and columns in the grid will be automatically determined when the grid is created. Thus, these fields cannot be edited by the user and will be dimmed. If refine points are not defined, the number of rows and columns must be entered.

When refine points are specified the user must enter the *Base size*, *Bias* and *Max size*. The *base size* is the size the user wants the cell to be right at the refine point. The *Max size* is the largest size that the user would like the cells to be in the entire grid. The *bias* determines how quickly the cell size will vary as they move away from the refine point. If using a bias of 1.1 then the row next to the refine point will be 1.1 times the *base size*. The next row will be 1.1 size the previous row.

Editing 3D Grids

Each cell in a 3D grid has attributes associated with it. Each grid cell can be specified as [active/inactive](#) and each cell has a [material](#) associated with it. To edit the cell attributes associated with a numerical model see [Cell Properties](#).

Rows, columns, or layers can be added or removed from a 3D grid. A row, column, or layer may be added to the grid by using one of the following tools found in the [3D Grid Tool Palette](#):

-  **Add i Boundary**
-  **Add j Boundary**
-  **Add k Boundary**



The boundary of a cell can also be moved to a new location by using the [Select Node](#) tool. Existing rows, columns, or layers can be deleted by using the **Merge Selected** command in the *Grid* menu which is used to merge two or more selected rows, columns, or layers into a

single row, column, or layer. Since the dimensions of the grid are changed, this command causes all datasets to be deleted. However, MODFLOW input parameters are preserved.

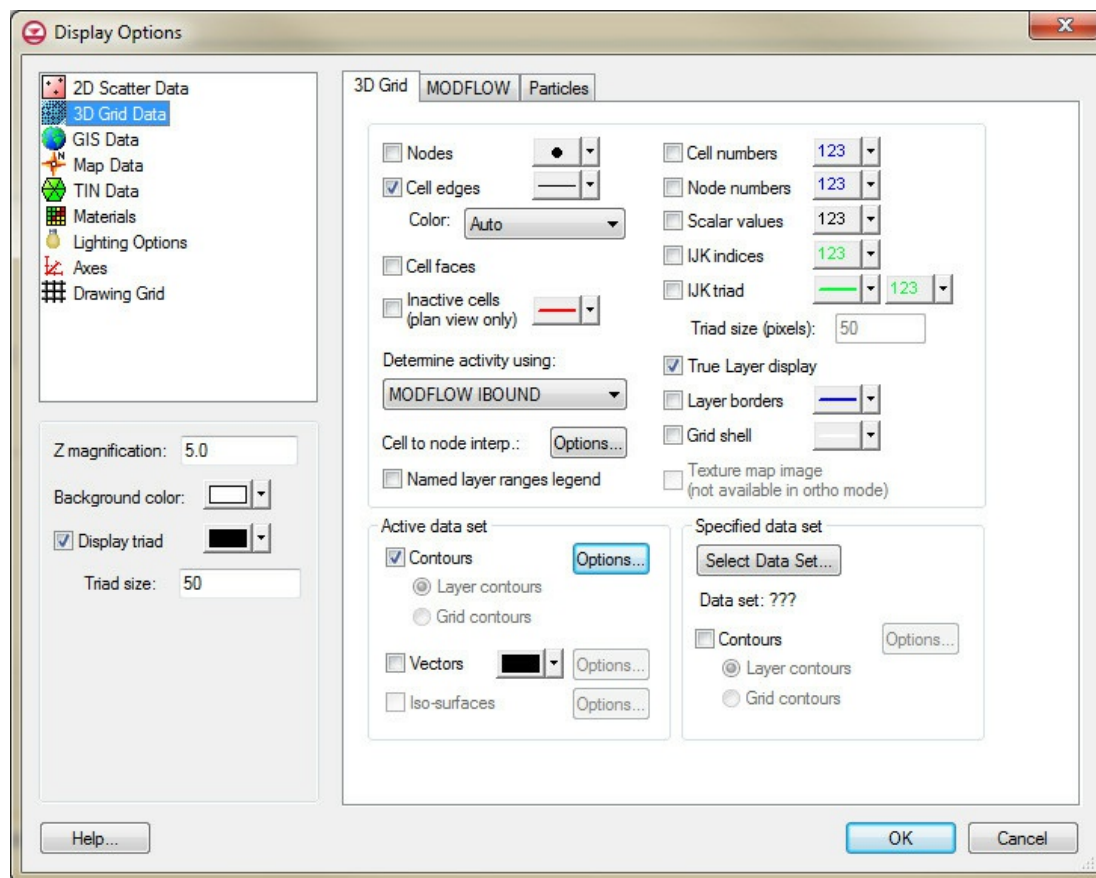
3D Grid Display Options









The Display Options dialog showing the 3D Grid dialog.

The properties of all **3D grid** data that GMS displays on the screen can be controlled through the **3D Grid** tab of the **Display Options** dialog. This dialog is opened by right-clicking on the 3D Grid Data  entry in the **Project Explorer** and selecting the **Display Options** command. It can also be accessed from the **Display** menu or the **Display Options**  macro. The following table describes the display options available for the 3D Grid module.





Display Option	Description
Nodes	The <i>Nodes</i> item displays grid node dots on the cell corners for both cell-centered and mesh-centered Grid Types .
Cell edges	The <i>Cell edges</i> item displays the edges of grid cells. The cells are either drawn using the default cell color or the color of the material associated with each cell. In addition to turning the display of cells on or off, GMS can temporarily hide grid cells. The color of the cell edges can be adjusted according to the following options: <ul style="list-style-type: none"> 1. Auto – draws the material color if faces are not displayed. Uses black or white if the faces are displayed 2. Specified – used the color specified next to the cell edges 3. Material – displays the material color of the cell
Cell faces	The <i>Cell faces</i> item causes the faces of the grid cells to be drawn as filled polygons.
Inactive cells	The <i>Inactive cells</i> item displays cells which are inactive. If this option is turned off, inactive cells are not displayed. Inactive cells must be displayed before they can be selected.
Named layer ranges legend	A legend showing the material and named layer ranges can be turned on.
Cell numbers	The <i>Cell Numbers</i> item displays the ID of each grid cell.
Node numbers	The <i>Node Numbers</i> item displays the ID of each grid node.
Scalar values	The <i>Scalar Values</i> item displays the scalar values of the active dataset for each node next to the node.
IJK indices	The <i>IJK indices</i> item displays the ijk indices of each cell or node.
IJK triad	The <i>IJK triad</i> item displays a symbol at one of the corners of the grid showing the orientation of the ijk axes.
True layer display	With MODFLOW models, a special option called the True Layer mode is available. If this mode is selected, the user provides a set of top and bottom elevation arrays for each layer. These arrays can be used to display the vertical variations in the stratigraphy when in one of the side views in orthogonal viewing mode or when in oblique view in general mode.
Layer borders	The <i>Grid boundary</i> item displays a solid line around the perimeter of the grid layers.
Grid shell	The <i>Grid shell</i> item displays a solid cube around the extents of the grid. Displaying the boundary is useful when isosurfaces are being displayed with the cell edges turned off.
Texture map image	The <i>Texture Map Image</i> item is used to "drape" an image over the surface of the 3D Grid.
Synch ortho levels with all grids	When using MODFLOW-LGR with parent and child grids, GMS will find and display the appropriate level for all grids when the level of the active grid changes. Otherwise only the active grid level will change.
Contours	Most of the objects supported by GMS can be contoured by turning on the Contour Options in the <i>Display Options</i> dialog. When an object is contoured, the values associated with the active dataset for the object are used to generate the contours.
Specified Dataset	Allows the user to display the contours of a second dataset that is specified by the user. All contouring options are the same for both the specified and active datasets.
Vectors	If the Vectors item in the <i>Display Options</i> dialog is selected for an object (TIN, Grid, or Mesh), vector plots can be generated using the active vector dataset for the object. One vector is placed at each node, cell, or vertex.
Isosurfaces	If the Isosurfaces item in the <i>Display Options</i> dialog is selected for an object (3D Grid or 3D Mesh), isosurfaces will be generated. An isosurface is the 3D equivalent of a contour line. While a contour line is a line of constant value extracted from a surface, an isosurface is a surface of constant value extracted from a 3D dataset.

3D Grid Tool Palette

The following tools are contained in the dynamic portion of the [tool palette](#) when the [3D Grid module](#) is active. Only one tool is active at any given time. The action that takes place when the user clicks in the [Graphics Window](#) depends on the current tool. The following table describes the tools in the 3D grid tool palette.

Tool	Tool Name	Description
	Select Cells	<p>The Select Cells tool is used to select individual grid cells. Multi-selection can be performed by holding down the <i>Shift</i> key while selecting or by dragging a rectangle to enclose the cells to be selected. The ijk indices of the selected cell are displayed in the Edit Window.</p> <p>Only visible cells can be selected. Cells which have been hidden cannot be selected. Inactive cells can only be selected when they are being displayed by turning on the <i>Inactive Cells</i> item in the Display Options dialog.</p> <p>When selecting cells by dragging a box, all cells that lie within the box are selected. When selecting cells by clicking on individual cells with the cursor, only cells on the exterior of the visible portion of the grid are selected. Cells in the interior of the grid can be selected individually by first hiding the layers, rows, or columns adjacent to the cells.</p>
	Select Node	<p>The Select Node tool is used to select nodes and to interactively edit cell boundary coordinates by clicking on the intersection of two cell boundaries and dragging the boundaries with the mouse button held down. The coordinates of the cell boundary intersection are displayed in the Edit Window as the boundaries are dragged. The coordinates of a selected boundary intersection can also be edited by directly entering the coordinates in the Edit Window.</p> <p>When dragging a boundary intersection, the intersection is moved in the plane of the face where the point was clicked. For example, when a boundary intersection on the top of the grid is dragged, the intersection is constrained to move in the XY plane. If a boundary intersection on the side of the mesh perpendicular to the X axis is dragged, the intersection is constrained to move in the YZ plane.</p> <p>If the <i>Control</i> key is depressed when dragging a boundary intersection in a view other than plan view, the intersection is constrained to move in a plane parallel to the viewing plane.</p>
	Select Material Zones	<p>The Select Material Zones tool is used to select all cells of the grid that have the same material type. This tool is useful for hiding or isolating zones in the grid corresponding to a material type. When this tool is active, an icon appears on the grid display for each of the material types. A material zone is selected by selecting the icon.</p>
	Select i	<p>The Select i tool is used to select an entire "row" (set of cells with the same i index) of cells at once. Multi-selection can be performed by holding down the <i>Shift</i> key while selecting. The i index of the selected row is displayed in the Edit Window.</p>
	Select j	<p>The Select j tool is used to select an entire "column" (set of cells with the same j index) of cells at once. Multi-selection can be performed by holding down the <i>Shift</i> key while selecting. The j index of the selected column is displayed in the Edit Window.</p>
	Select k	<p>The Select k tool is used to select an entire "layer" (set of cells with the same k index) of cells at once. Multi-selection can be performed by holding down the <i>Shift</i> key while selecting. The k index of the selected layer is displayed in the Edit Window.</p>
	Select Cross Sections	<p>Once a set of cross sections has been created, each cross section can be selected using the Select Cross Sections tool. Selected cross sections can be deleted, or they can be made visible or invisible using the Hide and Show commands.</p> <p>When this tool is active, a cross section icon appears on each cross section. A cross section is selected by selecting the icon. When a different tool is selected, the icons disappear. When there are several cross</p>

sections, it is often easier to differentiate cross section icons in plan view (assuming the cross sections were created in plan view). As a general rule the icons are placed in the center of the first line segment used to cut the cross section.

	Select Particle Starting Locations	Particle Starting Locations, used in particle tracking (MODPATH), can be selected with the Select Particle Starting Locations tool. Selected particles can be deleted. Statistical information for the selected particles, such as the path length and time, is displayed in the status bar.
	Add i Boundary	The Add i Boundary tool is used to insert a new i boundary into the grid. The new boundary is inserted at the cursor location when the mouse button is clicked. Inserting a new cell boundary changes the dimensions of the grid and all datasets associated with the grid are deleted. If the <i>control</i> key is held down while executing this command, the row will be evenly divided.
	Add j Boundary	The Add j Boundary tool is used to insert a new j boundary into the grid. The new boundary is inserted at the cursor location when the mouse button is clicked. Inserting a new cell boundary changes the dimensions of the grid and all datasets associated with the grid are deleted. If the <i>control</i> key is held down while executing this command, the column will be evenly divided.
	Add k Boundary	The Add k Boundary tool is used to insert a new k boundary into the grid. The new boundary is inserted at the cursor location when the mouse button is clicked. Inserting a new cell boundary changes the dimensions of the grid and all datasets associated with the grid are deleted. If the control key is held down while executing this command, the layer will be evenly divided.
	Create Cross Section	The Create Cross Section tool is used to create cross sections in a 3D. Cross sections are formed when the user enters a polyline. A polyline is entered by clicking on several points and double-clicking on the final point when the line is finished. The <i>Delete</i> or <i>Backspace</i> key may be used to remove a point from the polyline, and the <i>ESC</i> key can be used to abort the process. A cross section or fence diagram is then computed by cutting perpendicular to the current viewing orientation through the currently visible cells of the grid. While most cross sections are created with the grid in plan view, any viewing orientation can be specified. Datasets are automatically interpolated from the 3D grid to the cross sections for generation of contour and color fringe plots.

3D Grid Viewing Modes

When a 3D cell-centered grid is in memory, two viewing modes are available: **General Mode** and **Orthogonal Mode**. The general mode is the default mode and it is the mode used when a cell-centered 3D grid is not in memory. In general mode you can view the grid from top, front, or side view or from any oblique view. With the orthogonal view, the viewing direction are restricted to three views: looking down one of the *i*, *j*, or *k* axes. As you look down an axis, you view one row, column, or layer at a time. Oblique views and shading are not available in the orthogonal mode. The default viewing mode for cell-centered 3D grids is the orthogonal mode. Thus, whenever a new cell-centered grid is created or read from a file, GMS automatically goes into the orthogonal viewing mode

There are two main advantages of the orthogonal mode:

- It is a convenient way to view and manipulate layered models such as MODFLOW.
- Since you only view one row, column, or layer at a time, there are fewer things to display. Thus, redrawing a grid is much faster.

Switching Modes

A command is provided in the *View* menu for switching between the orthogonal and general viewing modes. If the current mode is orthogonal, the menu command is titled **Ortho Mode** will be selected. If the current mode is general, the command is titled **General Mode** will be selected. There is also a toolbar Macro that can be used to switch the mode .

Mini-Grid Plot

When in the orthogonal mode, the **Mini-Grid Plot** is activated in the [Tool Palette](#). The plot shows which row, column, or layer is currently being displayed. The edit field and arrows just beneath the plot can be used to change the current row, column, or layer. To change the view, select one of the **View Along I Axis**, **View Along J Axis**, or **View Along K Axis** macros at the bottom of the Tool Palette.

True Layer Mode

With **MODFLOW** models, a special option called the **True Layer** mode is available. If this mode is selected, the user provides a set of top and bottom elevation arrays for each layer. These arrays can be used to display the vertical variations in the stratigraphy when in one of the side views in orthogonal viewing mode or when in oblique view in general mode.

Converting 3D Grids to Other Data Types

3D Grid data can be converted to other types of data in GMS such as 2D grids, 2D scatter points, 3D Meshes, or 3D scatter points. 3D Grid data is converted using the following commands in the Grid menu:

Grid → 3D Scatter Points

The **Grid → Scatter Points** command in the *Grid* menu in the 3D Grid Module is used to create a new scatter point set using the nodes or cells of a 3D grid. A copy is made of each of the datasets associated with the grid and the datasets are associated with the new scatter point set.

Grid → 3D Mesh

A new 3D finite element mesh can be created from a 3D grid by selecting the **Grid → Mesh** command from the *Grid* menu in the *3D Grid* menu. An eight node quadrilateral element is created from each cell in the grid.

Grid → 2D Grid

A new 2D grid can be created from a 3D grid by selecting the **Grid → 2D Grid** command from the *Grid* menu in the 3D Grid module. This creates a 2D grid which matches the 3D grid, i.e., one cell is created in the 2D grid for each vertical (ij) column in the 3D grid. This command is typically used in conjunction with the **3D Data → 2D Data** command.

Grid → UGrid

A new unstructured grid can be created from a 3D grid by selecting the **Grid → UGrid** command from the *Grid* menu. The new [Ugrid](#) will use the dimension of the 3D Grid.

MODFLOW Layers → 2D Scatter Points

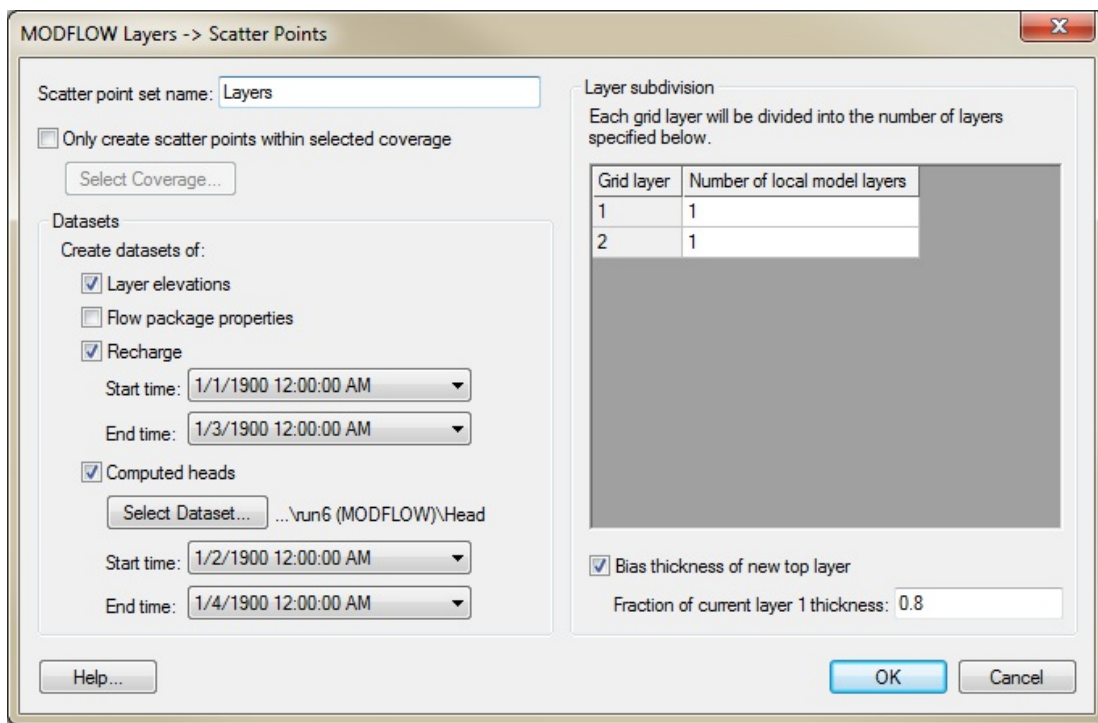

Example of the MODFLOW Layers → Scatter Points dialog

The **MODFLOW Layers → 2D Scatter Points** command in the *Grid* menu of the 3D Grid module is used for regional to local model conversion. It is only available if the true layer mode is being used with a MODFLOW model. When this command is selected, a new 2D scatter point set is created and a scatter point is created at the centroid of each vertical column of cells in the 3D grid. A dataset is then created on the scatter point set for the top and bottom elevations of each layer and for the computed head values (if a MODFLOW solution is in memory). The MODFLOW head data set is chosen in the following way: If a modflow head dataset is the active dataset then GMS uses that dataset for the starting heads. If the active dataset is in a modflow solution but is not a head dataset then GMS tries to use the head dataset in the active solution. If neither of the first 2 cases works then GMS just goes through the list of datasets and uses the last modflow head dataset that it finds (most likely the last solution that was read in). At a later point in time, these datasets can be interpolated from the scatter points to the cell centers of a smaller, local grid.

This dialog allows creating a scatter point set and datasets of the current MODFLOW simulation.

The process can limit the number of scatter points created by turning on the *Only create scatter points within selected coverage* option and selecting the appropriate coverage. This

is often used when converting between a regional model and a local scale model.

- *Layer Subdivision*

The layers of the current MODFLOW simulation can be subdivided by specifying the *Number of local model layers* for each layer in the current 3D grid.

Select which MODFLOW datasets to create by turning off/on the toggles below the *Create datasets of text*. Datasets for layer elevations, flow package data (HK, HANI, VK, SY, SS...), Recharge, and Heads can be created. The user must select a 3D grid dataset in order to create a dataset for the Heads (most often this will be the MODFLOW solution from the regional model).

The Recharge and Head datasets can be transient if the regional model was transient. The user can also select a Start and End time to limit the number of time steps for these datasets.

- *Bias Layer 1*

An option to bias the thickness of the new layer 1 is also available. This can be useful if equally subdividing layer 1 of the regional model would result in cells where the elevation would be above the computed heads. Thus, the user can choose to bias the thickness of the new layer 1 to ensure that the top layer in the new model will not be dry.

3D Data → 2D Data

The **3D Data → 2D Data** command in the *Data* menu of the [3D Grid module](#) is used to create datasets on a 2D grid created using the [Grid to 2D Grid](#) command. These two commands are useful for creating a 2D representation of a 3D dataset for contouring.

The **3D Data → 2D Data** command brings up the *3D Dataset → 2D Dataset* dialog. The button at the top of the dialog is used to select which 3D dataset is to be converted to a 2D dataset. The drop down box lists each of the options available for converting each column of 3D data values to a single 2D data value. The figure below shows an example of using the **3D Data → 2D Data** command.

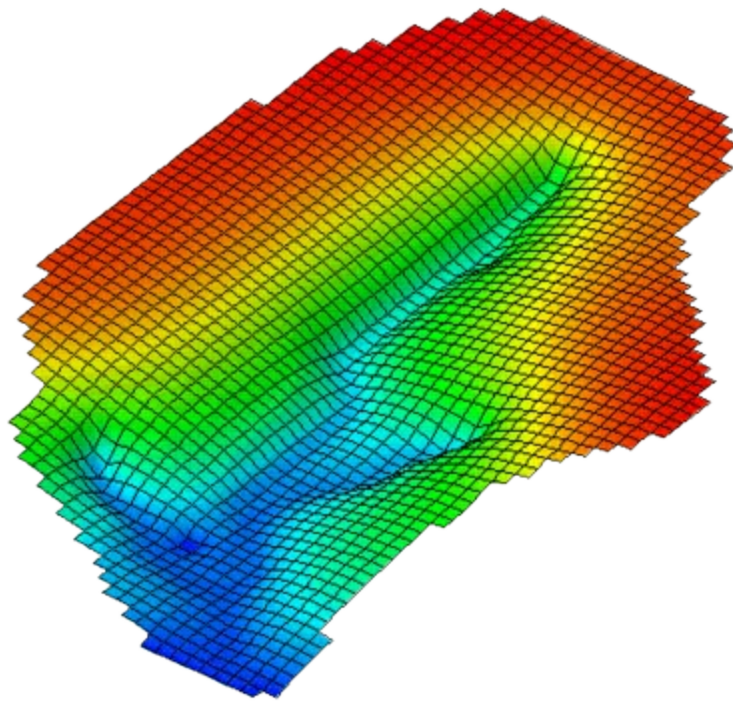

Watertable Elevations From a MODFLOW Simulation

Exporting Grids

2D and 3D grids can be exported from GMS in various formats by right-clicking on the grid in the [Project Explorer](#) and selecting the **Export** command. The options available include:

Exporting 2D grids

1. Text GMS 2D Grid File (*.2dg)

This is an older GMS grid file format that is described in [this document](#).

2. ARC/INFO Ascii Grid File (*.asc)

This is a raster format that can be opened in ArcMap. Because it's a raster, only use this option with cell-centered grids where all cells are the same size.

Exporting 3D grids

1. Text GMS 3D Grid File (*.3dg)

This is an older GMS grid file format that is described in [this document](#).

2. Shapefile

An ESRI ArcGIS compatible shapefile will be exported containing 2D polygons for all 3D grid cells in all grid layers. The attribute table fields include:

- cell ID
- cell I
- cell J
- cell K
- grid cell activity
- scalar dataset values (chose which datasets to save)
- dataset activity (if it exists)

A simple definition query using the grid cell activity and K fields can be created in ArcMap to see one layer of the grid at a time.

Active/Inactive Cells

Each of the cells in a cell-centered grid can be active or inactive. An inactive cell is a cell that is not part of the computational domain. An inactive cell is ignored when contours or vectors are displayed on the grid. Several methods are available for changing the active/inactive status of cells.

IBOUND/ICBUND Arrays

The active/inactive status of cells can also be controlled with model parameters. For example, MODFLOW uses an array of values known as the [IBOUND](#) array, to indicate what is active and what is inactive. If dataset flags are not currently present in the active dataset, and a MODFLOW simulation is currently in memory, the active/inactive status of cells will be determined by the IBOUND array. The [ICBUND](#) array in MT3DMS also has an effect on the active/inactive flags.

Activate Polygon Region

Active/inactive status of cells can be set using the [Activate Cells in Coverage](#) command in the [Map module](#). This command checks each cell in the grid to see if it is within the polygons defined in the MODFLOW/MT3DMS local Source/sink type coverage. All cells within the coverage are made active and all cells outside the coverage are made inactive. This command just modifies the IBOUND array in MODFLOW. If there is no MODFLOW model in memory, the command can hide the grid cells instead of making them inactive.

Dataset Flags

Often, the status of the cells of a finite difference grid will be determined from the solution to a numerical analysis. For example, a cell may go dry during a MODFLOW simulation, making the cell inactive. Two types of solution files supported by GMS may include active/inactive flags: [GMS dataset files](#) and MODFLOW solution files. After importing such a dataset, the active/inactive flags are stored with the datasets (or with the time steps of a transient dataset). When a dataset is selected as the active dataset, the flags (if they exist) are checked and any cell which is inactive is ignored when contouring and fringing. Active/inactive flags associated with datasets take

precedence over any other method of specifying active/inactive status. When the dataset is switched or deleted, the active/inactive flags for the grid revert to their previous values.

Active/Inactive Flags Dialog

In some cases, a dataset may not explicitly contain active/inactive flags, but the flags can be inferred from one or more key values. For example, a value of -999 in a dataset may mean that the cell is dry or inactive. A set of key values can be defined to set up the active/inactive flags for a dataset using the [Active/Inactive Flags](#) dialog. The *Active/Inactive Flags* dialog is accessed in the *Dataset Info* dialog. The active/inactive status of the cells is determined from the specified key values in the list. Any number of key values may be specified.



See also

- [Creating and Editing 3D Grids](#)

Named Layer Ranges

Starting at version 8.0, GMS allows creating named layer ranges via the *Grid* | **Named Layer Ranges** menu command. A layer range has a name, a [material](#), and a minimum and maximum layer.

- *Name* – Can be any name entered.
- *Material* – Enter the material ID number as define in the *Materials* dialog.
- *Min Layer* – The minimum layer range.
- *Max Layer* – The maximum layer range.
- *Material in undefined ranges* – Enter the material ID for any layers that are not defined above.
- *Update grid on OK* – Make the "Named Layer Ranges" material set the active set.

The order of the named layer range will determine range has precedence with named layer ranges on top having precedence over lower ranges. So if a layer range is from 1–5 and the layer range under it is 4–8, only layers 6–8 will receive the second layer name. The up ↑ and down ↓ arrows can be used to change this order. Rows can also be added  or deleted  to change the order.

If named layer ranges are defined, GMS will create a [material set](#) called "Named Layer Ranges" that matches the ranges defined in the dialog (if the material set already exists it is simply updated). If the *Update grid on OK* turned is on, GMS will make the "Named Layer Ranges" material set the active set. It is possible [display a legend](#) showing the named layer ranges.

Named layer ranges can be used in [T-PROGS](#) to target a subset of grid layers.

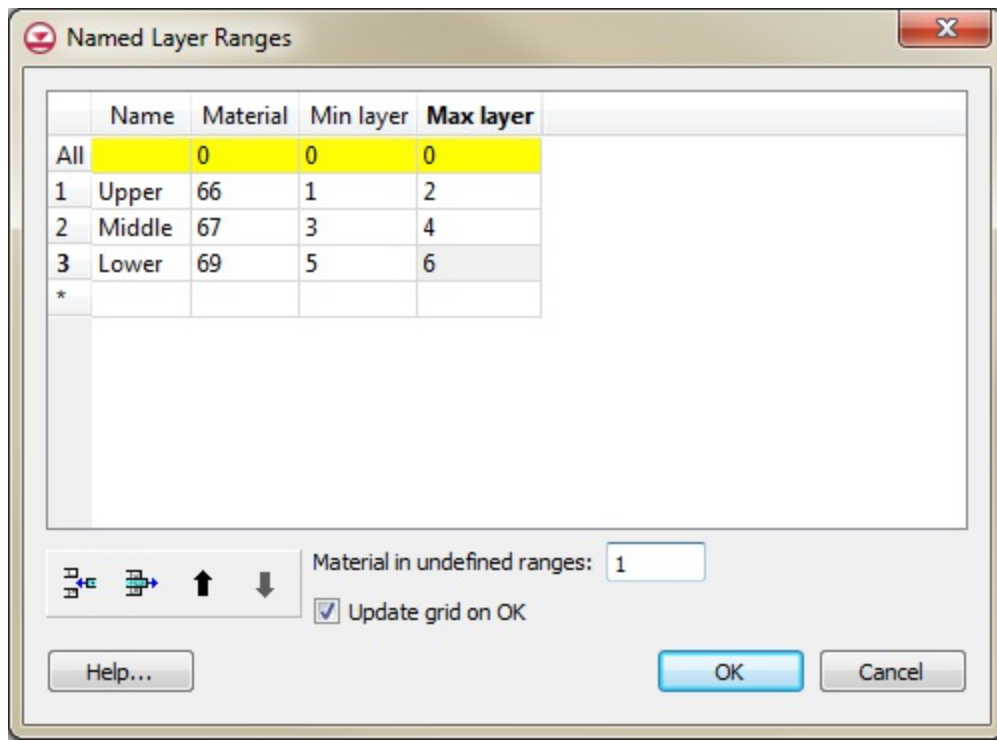

The Named Layer Ranges dialog

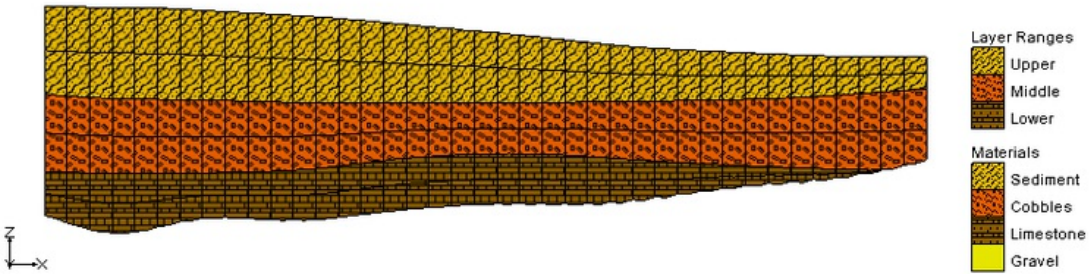

Redistribute Grid Cells

The number of [3D grid](#) rows, columns or layers can be changed via the *Redistribute Grid Cells* dialog. This dialog is accessed by selecting rows, columns or layers using the [Select i](#), [Select j](#) or [Select k tools](#), right-clicking and clicking the **Redistribute** menu command.

The *Redistribute Grid Cells* dialog indicates the number of ranks that are selected. The number of ranks equals the number of rows, columns, or layers depending on the tool used for the selection. It also allows entering a new number for the rank. Entering a new number will cause GMS to increase or decrease the number of ranks.

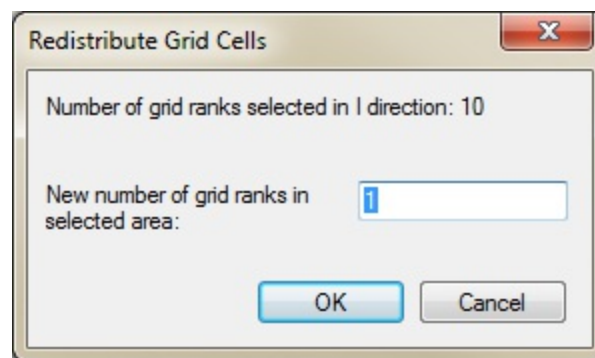

The Redistribute Grid Cells dialog

The new ranks are distributed evenly in the selected area and any model boundary conditions are positioned as close to their old locations as possible. Modifications may be necessary depending on the project needs. Ways to alter grid rows, columns and layers include:

- Grid ranks can be inserted manually using the [Add i Boundary](#), [Add j Boundary](#) and [Add k Boundary tools](#).
- Grid ranks can be merged manually using the [Select i](#), [Select j](#) or [Select k tools](#), right-clicking and selecting the **Merge** command.
- Use the [Redistribute Layers](#) dialog, accessed through the *Grid* menu, to alter the layer thickness.

Redistribute Layers

One way to alter [3D grid](#) layer thicknesses is via the *Redistribute Layers* dialog accessed via the *Grid | Redistribute Layers* menu command. This dialog has two sections: one section to specify grid top and bottom elevation and another section to specify layer thickness.

The dialog can specify grid elevation with the following options:

- *Specify top elevation* – Designates a constant top elevation for the grid.
- *Specify bottom elevation* – Designates a constant bottom elevation for the grid.

If not specified, GMS will evenly distribute the layer thickness to match the new elevation values, increasing or decreasing the thickness of all layers.

The layer thickness table lists all available layers and allows editing the relative thicknesses of each grid layer. It has the following options.

- *Edit* – Option must be checked to change the thickness of the layer. GMS requires that at least one layer not be selected as the thickness for this layer will automatically be calculated. If multiple layers are left unselected, GMS will even distribute the remaining layer thickness between the unselected layers.
- *Fraction* – Changes the thickness of the layer by the percentage value entered. The value needs to be a positive value between 0.01 and 0.99. GMS will automatically adjust the fraction value of other layers so the total equals 1 (100%).

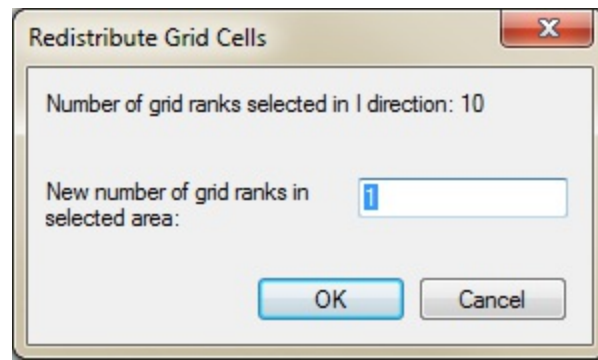

The Redistribute Layers dialog

Other ways to alter grid layer thicknesses:

- Dragging layer nodes with the **Select Node** tool.
- Using **Redistribute Grid Cells** dialog to change the number of layers.

3D Grid Commands

The *Grid* menu becomes available when the 3D Grid module is active. The menu has one submenu; the *Convert To* submenu. Below is a list of commands available in the *Grid* menu.

Create Grid...

Brings up the *Create Finite Difference Grid* dialog.

Merge Cells

This command will combine selected cells.

Redistribute Layers...

Brings up the *Redistribute Layers* dialog.

Named Layer Ranges...

Brings up the dialog better organize materials in multiple layers.

Find Cell...

Locates a cell based on "Cell ID" or "IJK" coordinates.

Find Node...

Locates a node based on "Cell ID" or "IJK" coordinates.

Isosurface Options...

Brings up the *Isosurface Options* dialog.

Isosurface Volumes...

Brings up the *Isosurface Volumes* dialog.

Convert To >

Grid → 3D Scatter Points

Creates a scatter point set with a point on the center of each cell with the value of the cell.

Grid → 3D Mesh

Creates a mesh typically from the cell centered values in the grid for the different layers. The first dialog allows choosing between the cell centers or the cell corners to create the mesh. A disclaimer is given that data values are given at the cell center and that datasets will not be converted.

Grid → 2D Grid

Creates a flat grid from the 3D grid dimensions at a given elevation.

Grid → UGrid

Creates an unstructured grid from the 3D grid.

MODFLOW Layers → 2D Scatter Points...

Converts all MODFLOW Layers that have values into scatter point sets.

Layer Contours → Arcs

Converts layer contours into arcs that can be manipulated as drawing objects.

Layer Contours → Shapefile

Exports layer contours to a line shapefile.

3D data → 2D data

Converts the 3D data to 2D data according to a user defined option (average, highest active value, maximum, minimum, sum, and value from k-layer) to get a single value from the multiple layers.

New Material Set

Creates a new [material set](#) in the Project Explorer.

Zoom To Extents

Frames the Graphics Window around the selected objects.

Related Topics

- [3D Grid Module](#)
- [Converting 3D Grids to Other Data Types](#)

5.9. 3D Scatter Point Module

3D Scatter Point Module

The 3D Scatter Point module is used to interpolate from groups of 3D scatter points to meshes, grids, or TINs. Several interpolation schemes are supported including [inverse distance weighted interpolation](#) and [kriging](#).

[Interpolation](#) is useful for setting up input data for analysis codes and it is also useful for site characterization.

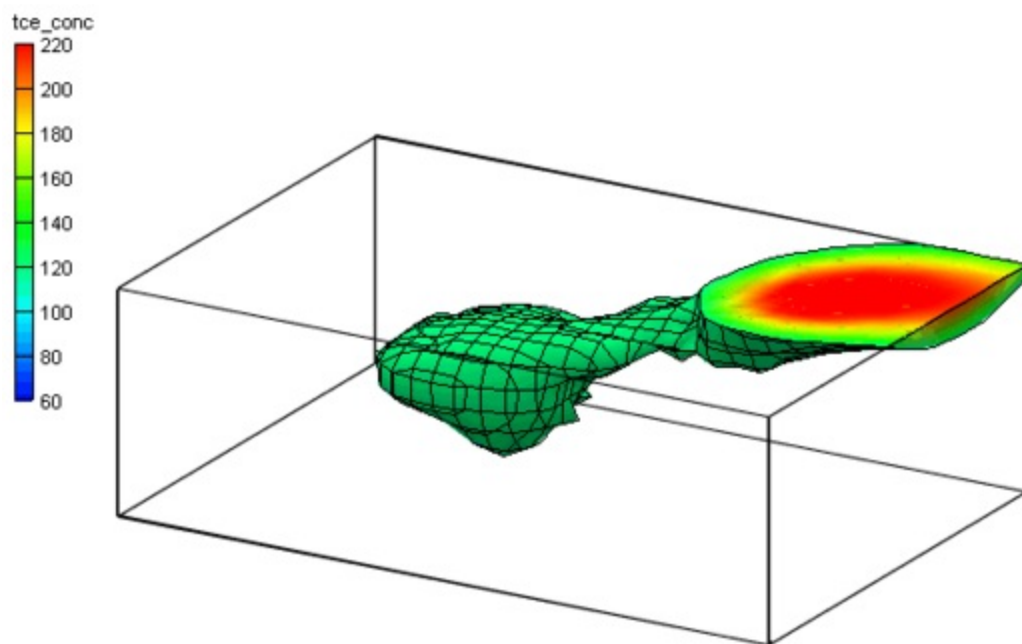

Interpolation of TCE data to a 3D grid

A number of [tools](#) are included for creating and manipulating 3D scatter point sets. In general, 3D scatter sets are imported using the [File Import Wizard](#). 3D scatter sets can also be created from other objects in GMS such as GIS objects, feature objects, meshes, grids, TINs, etc.



Multiple 3D scatter sets can be in the module. Existing scatter sets can be duplicated or merged together.

Besides interpolating 3D scatter sets to other data, the module can also be used to create objects from the scatter data.

The module contains its own [display options](#) which include contour displays. Also, each scatter point has an [active/inactive](#) status. A scatter point with an inactive status can be displayed, but the dataset value at the point is ignored when interpolation takes place.

The 3D Scatter Point module also allows exporting scatter sets by right-clicking on the scatter set and selecting the **Export** command. Options for export include: Text Tab Delimited 3D Scatter Point Files (*.txt), Text GMS 3D Scatter Point Files (*.xyz), and Shapefiles (*.shp).

3D Scatter Point Display Options

The properties of all **3D scatter** data that GMS displays on the screen can be controlled through the **3D Scatter** tab of the **Display Options** dialog. This dialog is opened by right-clicking on the 3D Scatter Data  entry in the **Project Explorer** and selecting the **Display Options** command. It can also be accessed from the **Display** menu or the **Display Options**  macro. The following table describes the display options available for the 3D Scatter Point module.

Display Option	Description
Active scatter point set	The name of the active scatter point set is listed at the top of the dialog. The symbol selected using the Scatter point symbols option (described below) applies to the active scatter point set. This makes it possible to use a different set of symbols for the points in each set so that the sets are easily distinguishable.
Scatter point symbols	<p>The Scatter point symbols item displays a symbol at the location of each scatter point. The widget to the left of the toggle is used to bring up a dialog listing the available symbols. The color of each of the scatter points in a set may be changed in this dialog also.</p> <p>The color of the scatter points can be adjusted according to the following options:</p> <ol style="list-style-type: none">1. Specified – used the color specified next to the scatter point symbols2. Data – the color ramp is used to assign a color to each of the symbols according to the value of the active scalar dataset
Inactive scatter points	Individual scatter points can either be active or inactive . The Inactive scatter points option is used to show inactive scatter points and to set their color.
Scatter point scalar values	The Scatter point scalar values option displays the value of the active dataset next to each of the scatter points.
Scatter point labels	The Scatter point labels item displays the scatter point label next to each scatter point.
Scatter point numbers	The Scatter point IDs item displays the scatter point ID next to each scatter point.
Symbol legend	The Symbol legend item displays a symbol legend listing each of the scatter point sets by name and showing the symbol associated with the scatter point sets.

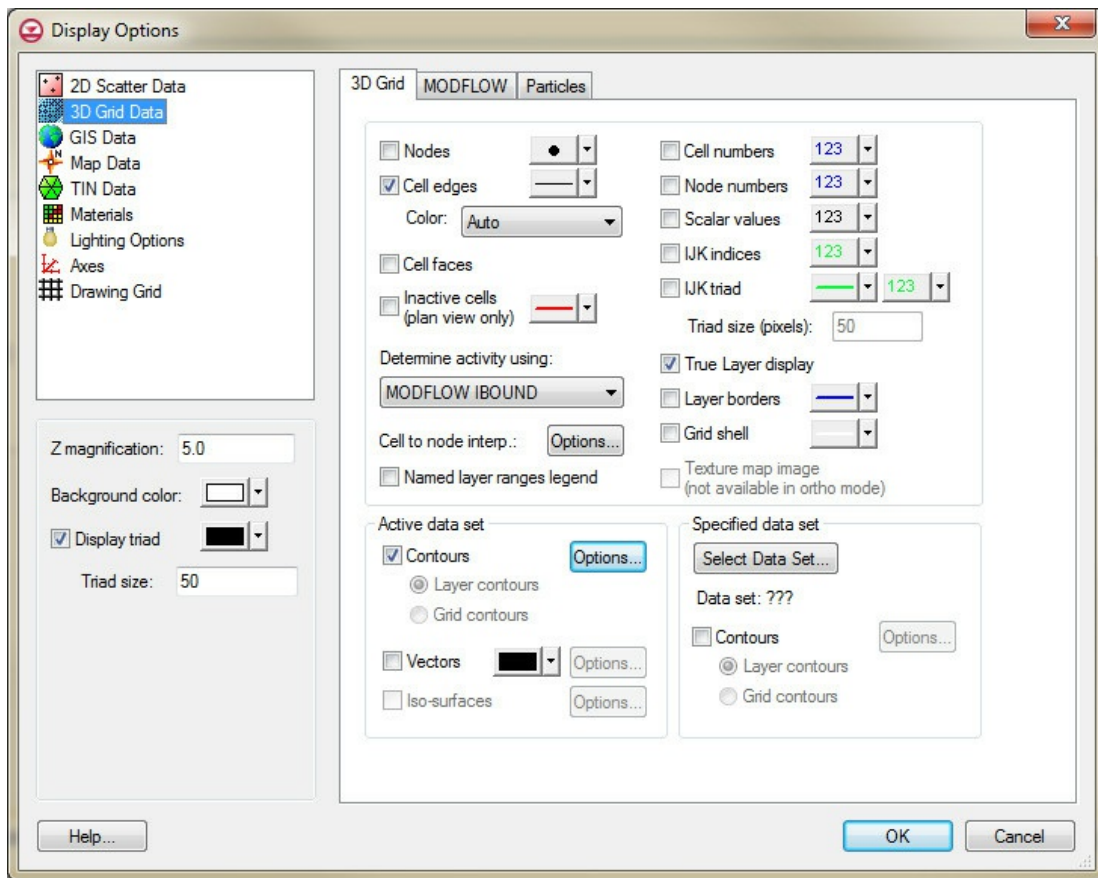

The Display Options dialog showing the 3D Scatter Point Set tab.

3D Scatter Point Tool Palette

The following tools are active in the dynamic portion of the [tool palette](#) whenever the [3D Scatter Point module](#) is active. Only one tool is active at any given time. The action that takes place when clicking in the [Graphics Window](#) with the cursor depends on the current tool. The list below describes the tools in the 3D scatter set tool palette.

Select Scatter Point

Used to select individual scatter points for editing using the Edit Window. Scatter points can also be dragged with the mouse. Scatter points can be deleted. With extremely large sets of scatter points, it may become difficult to identify a scatter point with a particular ID, even if the scatter point IDs are being displayed. In such cases, the **Find Point** command in the *Scatter Points* menu can be used to quickly locate a point. The command prompts for the ID of the desired point and the point is selected.

Select Scatter Point Set

Used to select entire scatter point sets for deletion or to designate the active scatter point set. When this tool is active, an icon appears at the centroid of the set for each of the scatter point sets. A scatter point set is selected by selecting the icon for the set.

Create Scatter Point

Used to interactively create scatter points by clicking in the GMS graphics window.

Related Topics

- [3D Scatter Point Module](#)

Interpolating with 3D Scatter Points

Scatter point sets are used for interpolation to other data types such as TINs, grids, and meshes.

Interpolation is useful for such tasks as contouring or setting up input data to a model. Since no interpolation scheme is superior in all cases, several [interpolation techniques](#) are provided in GMS.

The basic approach to performing an interpolation is to select an appropriate interpolation scheme and interpolation parameters, and then interpolate to the desired object using one of the [3D Interpolation Commands](#).

The interpolation options are selected using the [Interpolation Options dialog](#) accessed through the **Interpolation Options** command in the *Interpolation* menu. Once a set of options is selected, those options are used for all subsequent interpolation commands. Interpolation options are saved in the project file.

A 3D grid can be created which will enclose the scatter points by using the [Bounding 3D Grid](#) command in the *Scatter Points* menu. A 2D grid can also be created using the [Bounding 2D Grid](#) command in the *Scatter Points* menu.

Interpolation Methods

The following [methods](#) are supported for 3D interpolation in GMS:

- [Inverse Distance Weighted Interpolation](#) – Based on the assumption that the interpolating surface should be influenced most by the nearby points and less by the more distant points.
- [Kriging](#) – Based on the assumption that the parameter being interpolated can be treated as a regionalized variable.

[Log interpolation](#) is also supported.

Related Topics

- [Interpolation](#)

Converting 3D Scatter Points to Other Data Types

3D Scatter Points may be converted to [3D Mesh Nodes](#) or [Observation Points](#) by using the following commands available either in the *Scatter Points* menu or by right-clicking on a scatter set in the [Project Explorer](#):

Scatter Points → Mesh Nodes

The **Scatter Points → Mesh Nodes** command is used to convert each of the scatter points to a 3D mesh node. The nodes can then be used to generate a mesh using the **Tessellate** command in the *Mesh* menu. The *Mesh* menu can be made visible by selecting the 3D Mesh module.

Scatter Points → Obs. Pts.

The **Scatter Points → Obs. Pts.** command in the *Scatter Points* menu of the 3D Scatter Point module creates a new observation coverage with one observation point for each of the 3D scatter points in the active scatter point set. The measured values for the new observation points are taken from the scatter set's active dataset values.

MODPATH Starting Locations

The **Convert To → MODPATH Starting Locations** command creates [MODPATH](#) starting locations from the 3D scatter sets selected in the Project Explorer. A new particle set is created for each 3D scatter point set. This command is available by right-clicking on a 3D scatter set in the [Project Explorer](#). MODPATH starting locations can also be converted to 3D scatter points [via the MODPATH menu](#).

Bounding Grid

In many cases, it is useful to interpolate to a 3D grid which just contains the points from a 3D scatter set. The **Bounding Grid** command was designed in order to simplify the creation of such a grid. Selecting the **Bounding Grid** command from the *Scatter Points* menu brings up the *Create Finite Difference Grid* dialog pre-filled with grid dimensions set at 10% beyond the bounds of the active scatter point set.

Origin, Length, Rotation – By default, the rows and columns of 2D grids are aligned with the x and y axes. However, grids can be rotated about the z-axis, if desired. Thus, the information needed to determine the overall size and location of the grid is the xy coordinates of the lower left corner of the grid (the lower left corner prior to rotation), the length of the grid in the x and y directions, and the rotation angle. The xy coordinates of the origin are entered in the *Origin* edit fields, the dimensions are entered in the *Length* fields, and the angle of rotation is entered in the field entitled *Rotation* about Z-axis.

Bias – Several options are available for defining the number and locations of the cell boundaries. A bias can be defined which controls how the cell size varies from one cell to the next. For example, an X bias of 1.5 causes each cell to be 50% larger than the previous cell when moving in the positive x direction.

Number of Cells – The total number of cells in each direction (number of rows or columns) can be defined by explicitly entering a number or by entering a base cell size and a limit cell size. The base and limit cell size options are used when a bias other than 1.0 is specified. The base cell size is the size of the first cell in the sequence. The cells are then generated by altering the cell size according to the bias until the limit cell size is reached. The remainder of the cells are constructed using the limit cell size.

Type and Orientation – The controls at the bottom of the *Create Grid* dialog are used to define the type and orientation of the grid. Specify whether the grid should be a mesh-centered grid or a cell-centered grid. The orientation of the ij axes with respect to the XY axes can also be specified.

See [Create Grid](#) for more information on this dialog.

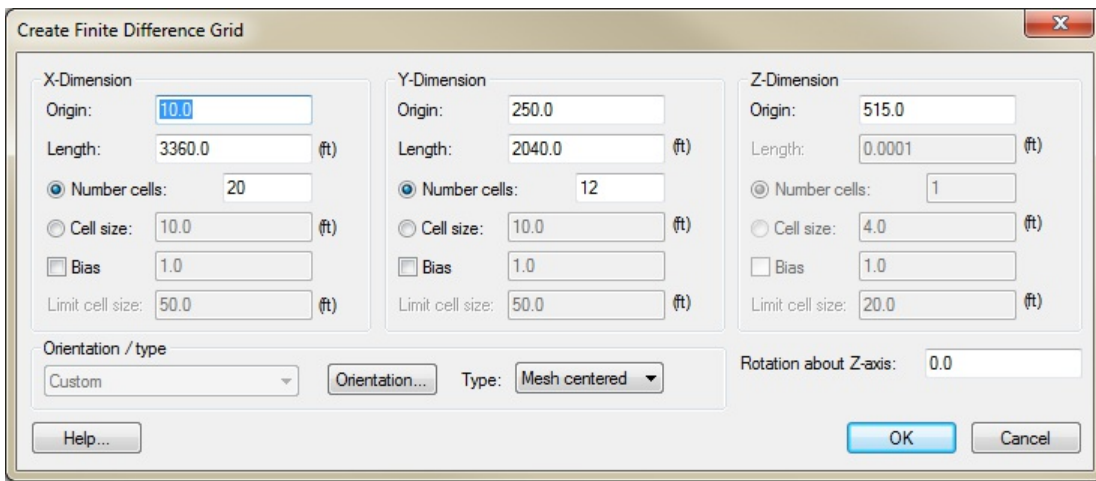

The Create Finite Difference Grid dialog

3D Scatter Point Commands

The *Scatter Points* menu become available when the 3D Scatter Point module is active. The menu has one submenu; the *Interpolation* submenu. The menu has the following commands:

New Scatter Point Set

Creates a new dataset.

Lock All Scatter Points

Prevents adjusting the location of scatter points.

Scatter Point Settings...

Opens the Scatter sets tab under the [Preferences](#) dialog.

Find Point...

Locates a point based on ID number or text label.

[Interpolation >](#)

Interpolation Options...

Sets the interpolation options used when interpolating to other objects. The interpolation options are saved with the project.

Interpolate → Active TIN

Interpolate the active dataset on the active scatter set to the active TIN.

Interpolate → 2D Mesh

Interpolate the active dataset on the active scatter set to the 2D mesh.

Interpolate → 2D Grid

Interpolate the active dataset on the active scatter set to the 2D grid.

Interpolate → 3D Mesh

Interpolate the active dataset on the active scatter set to the 3D mesh.

Interpolate → 3D Grid

Interpolate the active dataset on the active scatter set to the 3D grid.

Interpolate → UGrid

Interpolate the active dataset on the active scatter set to the active UGrid.

Gaussian Simulation Options...

[Gaussian Sequential Simulation \(GSS\)](#) is a form of Kriging that can only be used

for 2D interpolation and only works when interpolating to 3D cell-centered grids.

Run Gaussian Simulation

Launches the [Gaussian simulation run](#).

Jackknifing...

Interpolates the active scatter point set to itself using the currently selected interpolation scheme.

Summary...

Brings up the [Jackknifing Summary](#) dialog.

Bounding 2D Grid...

Creates a 2D Grid that bounds or contains all of the scatter points in the active set.

Bounding 3D Grid...

Creates a 3D Grid that bounds or contains all of the scatter points in the active set.

Scatter Points → Mesh Nodes

Creates nodes from the scatter points for a 2D mesh.

Scatter Points → Obs. Pts.

Creates Observation Points from the active dataset. A coverage that is set for observation data must already exist.

Merge Scatter Point Sets

Creates a merged scatter set from two or more scatter sets selected with the [Select Scatter Sets](#) tool.

Zoom To Extents

Frames the Graphics Window around the selected objects.

Related Topics

- [3D Scatter Point Module](#)

5.10. Map Module

Map Module

The Map module provides a suite of tools for using [feature objects](#) to build [conceptual models](#).

Feature objects are used to provide some GIS-like capabilities within GMS. Feature objects include points, arcs, and polygons. Feature objects can be grouped into layers or [coverages](#). Multiple coverages and conceptual models can exist in a single GMS project. A set of coverages can be constructed representing a conceptual model of a groundwater modeling problem. This high level representation can be used to automatically generate numerical models such as MODFLOW and MT3DMS. Feature objects can also be used for automated mesh generation.

The Map module is often used as a starting point for many project. Often, a project starts with an [image](#) then, on a coverage, the [module tools](#) are used to create feature objects over the image to represent boundaries and structures. Then the feature objects are [converted](#) to other data types for further processing.

For the purpose of converting feature objects to 2D or 3D grids, the module contains a [grid frame](#) tool to define the boundaries and properties of the grid being created.

The Map module also contains its own [menu commands](#) and its own [display options](#).

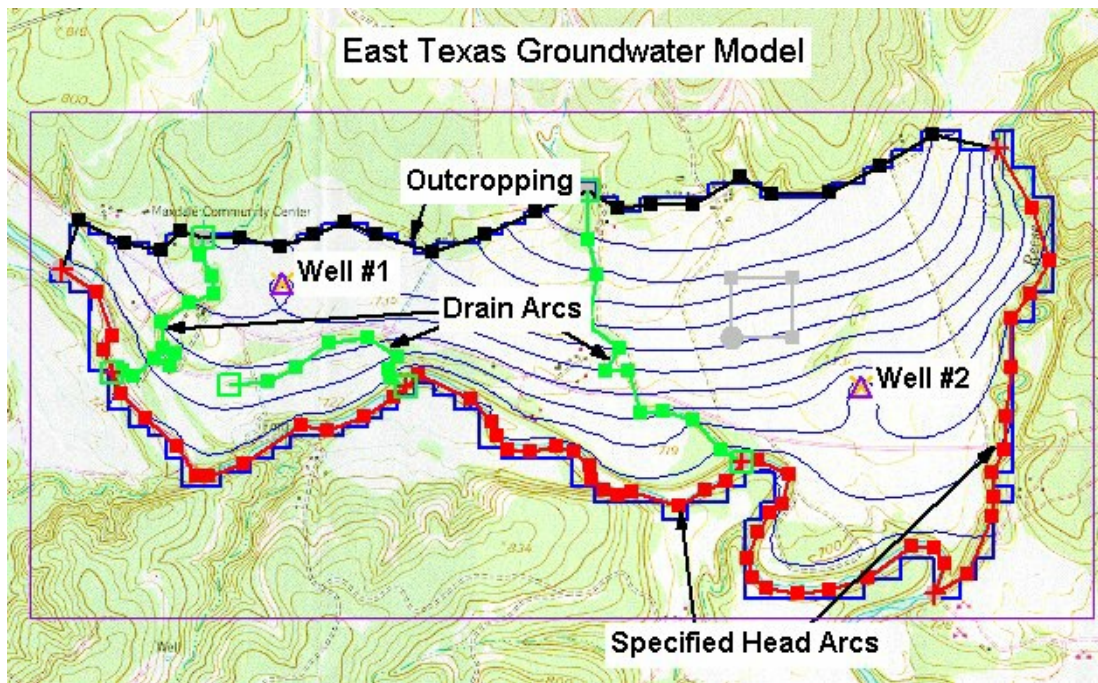

Example of feature objects drawn on a coverage over an image

The Map module, including the conceptual modeling tools, is included with all [paid editions](#) of GMS.

Feature Objects

Feature objects in GMS have been patterned after Geographic Information Systems (GIS) objects and include points, nodes, arcs, and polygons. Feature objects can be grouped together into coverages, each coverage defining a particular set of information. Since feature objects are patterned after GIS objects, it is possible to [import and export](#) feature objects to a GIS program such as Arc/Info or ArcView.

The primary use of feature objects is to generate a high level conceptual model representation of a site. In such a model, items such as rivers, drains, wells, lakes are represented with points, arcs, and polygons. Attributes such as conductance, pumping rates, and elevations are defined with the objects. This conceptual model is then used to automatically generate a grid or mesh and assign the boundary conditions and model parameters to the appropriate cells. Thus, the user can focus on a simplified, high level representation of the model and little or no tedious cell-by-cell editing is required. The feature object approach can be used to build models for [SEEP2D](#), [FEMWATER](#), [MODFLOW](#), [MT3DMS](#), [RT3D](#), and [SEAM3D](#). Feature objects are also used to construct cross sections.

Object Types

The definition of feature objects in GMS follows the paradigm used by typical GIS software that supports vector data. The basic object types are points, nodes, vertices, arcs, arc groups, and polygons. The relationship between these objects is illustrated in the following figure.

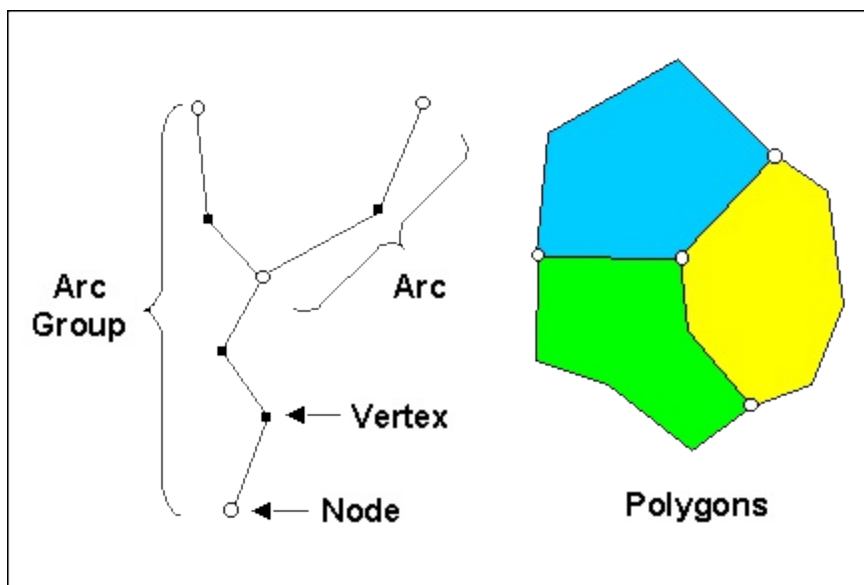

Feature object types

Points

Points are XY locations that are not attached to an arc. Points have unique IDs and can be assigned attributes. Points are often used to represent wells. Points are also used when importing a set of XY locations for the purpose of creating arcs or polygons.

Arcs

Arcs are sequences of line segments or edges which are grouped together as a single "polyline" entity. Arcs have unique IDs and can be assigned attributes. Arcs are grouped together to form polygons or are used independently to represent linear features such as rivers. The two end points of an arc are called "nodes" and the intermediate points are called "vertices".

Create Arc Group

This command is used to create an arc group from a set of selected arcs. Once the arc group is created, it can be selected using the **Select Arc Group** tool. Properties can be assigned to the arc group as a whole, and the arc group can be selected to display the computed flow through the arc group. An arc group is deleted by selecting the arc group and selecting the *Delete* key. Deleting an arc group does not delete the underlying arcs.

Reverse Arc Direction

Each arc has a direction. One node is the "from" node, the other node is the "to" node. For most applications, the direction of the arc does not matter. However, when the arc is used to define a MODFLOW stream network, the direction of the arc becomes significant. The **Reverse Arc Direction** command can be used to change the direction (upstream to downstream) for a stream type arc.

Nodes

Nodes define the beginning and ending XY locations of an arc. Nodes have unique IDs and can be assigned attributes.

Vertices

Vertices are XY locations along arcs in between the beginning and ending nodes. They are used solely to define the geometry of the arcs. Vertices do not have IDs or attributes.

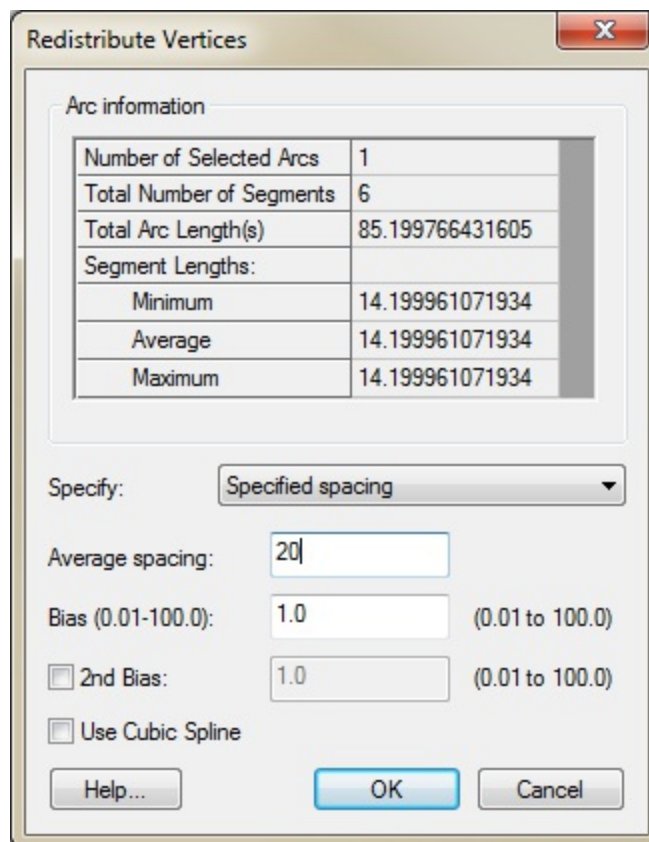

The Redistribute Vertices dialog

Redistribute Vertices

The primary function of the vertices of an arc is to define the geometry of the arc. In most cases, the spacing of the vertices does not matter. However, if the arcs are to be used for automatic mesh generation, the spacing of the vertices is important. In this case, the spacing of the vertices defines the density of the elements in the resulting mesh. Each edge defined by a pair of vertices becomes the edge of an element. The mesh gradation is controlled by defining closely spaced vertices in regions where the mesh is to be dense and widely spaced vertices in regions where the mesh is to be coarse.

When spacing vertices along arcs, the **Redistribute vertices** command in the *Feature Objects* menu can be used to automatically create a new set of vertices along a selected set of arcs at either a higher or lower density. The desired arc should be selected prior to selecting the **Redistribute vertices** command. The **Redistribute vertices** command brings up the *Redistribute Vertices* dialog. The following options are available for redistributing vertices:

Linear Interpolation – If the Linear interpolation option is specified, then either a number of subdivisions or a target spacing can be given to determine how points are redistributed along the selected arcs. In either case, the new vertices are positioned along a linear interpolation of the original arc.

Spline Interpolation – If the Spline interpolation option is specified, vertices are redistributed along a series of cubic splines defined by the original vertices of the selected arcs. The difference between the linear and spline interpolation methods is illustrated below:

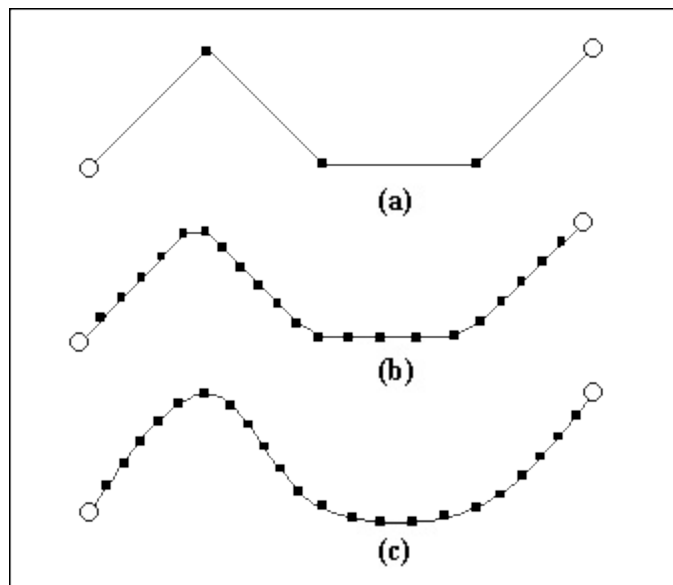

Redistributing vertices: (a) original arc (b) linear interpolation (c) spline interpolation

Vertex to Node

In some cases, it is necessary to split an arc into two arcs. This can be accomplished using the **Vertex** ↔ **Node** command. Before selecting this command, a vertex on the arc at the location where the arc is to be split should be selected. The selected vertex is converted to a node and the arc is split in two.

The **Vertex** ↔ **Node** command can also be used to combine two adjacent arcs into a single arc. This is accomplished by converting the node joining the two arcs into a vertex. Two arcs can only be merged if no other arcs are connected to the node separating the arcs. Otherwise, the node must be preserved to define the junction between the branching arcs.

Arc Groups

An arc group is a set of arcs that has been marked as a group by the user. As an arc group, attributes can be assigned to the entire group rather than to individual arcs. An arc group can also be selected as a single unit. Arc groups are primarily used for [flow observations](#).

Polygons

Polygons are a group of connected arcs that form a closed loop. A polygon can consist of a

single arc or multiple arcs. If two polygons are adjacent, the arc(s) forming the boundary between the polygons is shared (not duplicated).

Polygons may not overlap. However, a polygon can have a hole defined by having a set of closed arcs defining interior polygons. An example of such a case is shown in the figure below where three arcs are used to define two polygons. Polygon A is made up of arcs 1, 2, 3 and 4, whereas polygon B is defined by a single arc (arc 2). For polygon A arcs 1, 3, and 4 define the exterior boundary whereas arc 2 defines a hole.

Polygons have unique IDs and can be assigned attributes. Polygons are used to represent material zones, lakes, variable head zones, etc.

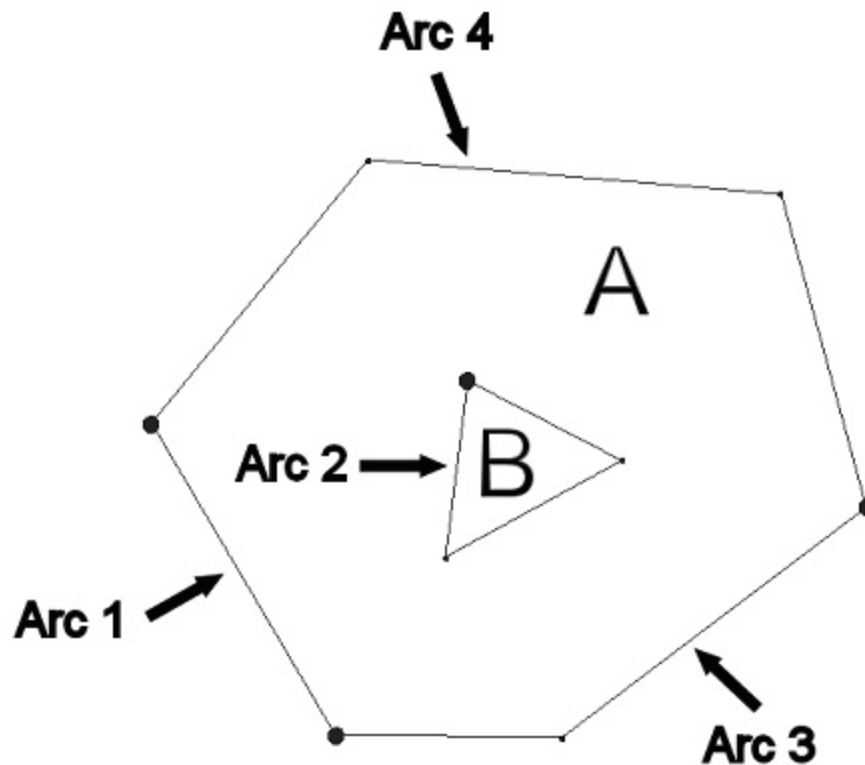

Polygon with holes

Build Polygons

While most feature objects can be constructed with [tools](#) in the Tool Palette, polygons are constructed with the **Build Polygons** command. Since polygons are defined by arcs, the first step in constructing a polygon is to create the arcs forming the boundary of the polygon. Once the arcs are created, they should be selected with the [Select Arc](#) tool, and the **Build Polygons** command should be selected from the *Feature Objects*

menu. If the selected arcs do not form a valid loop, an error message is given.

The **Build Polygons** command can be used to construct one polygon at a time or to construct several polygons at once. If the selected arcs form a single loop, only one polygon is created. If the arcs form multiple loops, a polygon is created for each unique (non-overlapping) loop. If no arcs are selected, all of the currently defined arcs in the active coverage are used to create polygons.

Coverages

Feature objects are grouped together into [coverages](#). Each coverage represents a particular set of data. For example, one coverage can be used to define recharge zones, and another coverage can be used to define zones of hydraulic conductivity.

Conceptual Models

In a generic sense, a conceptual model is a simplified, high level model of a site. In GMS, a conceptual model object consists of a set of coverages which are tied to a particular numerical model like MODFLOW or FEMWATER. The coverages below a conceptual model can have attributes that are related to the numerical model. For example, a coverage below a MODFLOW conceptual model can have drain or river arcs.

Feature Object Properties

The *Feature Object Properties* dialog is used to edit the properties of points, nodes, arcs, arc groups, and polygons. Three filters are located at the top of the dialog.

The *Feature type* combo box is used to choose which feature (point, arcs...) the spreadsheet displays. The Show combo box will show only the selected features or all features depending on which option is selected. The *BC type* combo box is used to display only certain boundary conditions. For example, if the filter is changed to "well," then only the wells would be displayed in the spreadsheet.

The *Show point coordinates* toggle is used to display the (x, y, z) coordinates of each point

in the spreadsheet. The **Add Point** and **Delete Point** buttons are used to create new points or remove points from the coverage.

The spreadsheet displays an attribute table associated with the current feature type (point, arc...). The columns available in the spreadsheet depend on the options selected in [Coverage Setup](#) dialog.

Converting Feature Objects

Feature objects can be converted to other data types in GMS such as cross sections and scatter points. This can be accomplished by either right-clicking on a [conceptual model](#), [coverage](#), grid frame, or by selecting a command from the *Feature Objects* menu. These commands are summarized on the following pages.

- [Map to Modules](#)
- [Map to Models](#)

Feature Object Commands

The *Feature Objects* menu becomes available when the conceptual model, or Map model, is active. The menu has the following commands:

Build Polygons

Creates polygons out of closed arcs.

Vertices↔Nodes

Switches selected vertices to nodes and vice versa.

Vertices → Node

Switches selected vertices to nodes.

Nodes → Vertices

Switches selected nodes to vertices.

Redistribute Vertices...

Redistributes the amount of vertices on a selected arc using an input value for spacing.

Create Arc Group

Creates the select multiple arcs as one. All arcs are still separate arcs, but one group.

Reverse Arc Direction

Arcs have a direction that follows the path that they were made. Direction is important with some parameters and need to be consistent throughout the model.

Clean...

Selecting this command brings up the *Clean* dialog. See [Clean Command](#) for more information.

Find Feature Object...

Select a feature object using the object ID.

New Grid Frame

Creates a new grid frame object in the project explorer.

Activate Cells in Coverage(s)

After creating a coverage that defines the model boundary and creating a grid, just the cells that are in the active coverage with remain active.

Arc(s) → Cross Section

Opens the *Arcs → Cross Sections* dialog. See [Arc → Cross Sections](#) for more information.

Map → TIN

This command creates a TIN using each polygon in the coverage.

Map → 2D Mesh

This command creates a 2D Mesh on the interior of all of the polygons in the current coverage. See [Map to 2D Mesh](#) for more information.

Map → 2D Grid

Opens the *Create Grid* dialog. See [Map to 2D Grid](#) for more information.

Map → 3D Grid

Opens the *Create Grid* dialog. See [Map to 3D Grid](#) for more information.

Map → UGrid

Opens the *Map→UGrid* dialog. See [Map → UGrid](#) for more information.

Map → 2D Scatter Points

Creates a scatter point set from the points and nodes and vertices of the current coverage. See [Map to 2D Scatter Points](#) for more information.

Map → 3D Scatter Points

Creates a scatter point set from the points and nodes and vertices of the current coverage. See [Map to 3D Scatter Points](#) for more information.

Map → MODFLOW

Opens the *Map → MODFLOW Options* dialog. See [Map to MODFLOW](#) for more information.

Map → SEAM3D

Map → FEMWATER

This command assigns the wells, boundary conditions, and recharge zones assigned to the points, arcs, and polygons. See [Map to FEMWATER](#) for more information.

Map → SEEP2D

Converts a conceptual model to a SEEP2D numerical model.

Map → WASH123D

Map → ADH

Copy to Coverage...

Opens a dialog allowing for selection of one or more coverages which selected feature

objects will be copied to. This may result in overlapping and/or intersecting objects.

Zoom To Extents

Frames the Graphics Window around the selected objects.

Set Arc Directions From Stream Data

Uses the stream top elevations defined at the nodes to make the arcs point downhill.

Only works for the STR package (not SFR2).



Set Arc Directions From Node Elevations

Uses the Z value at the nodes to make the arcs point downhill.

Related Topics

- [Map Module](#)
- [Conceptual Model](#)

Conceptual Model

A conceptual model  is a group of  coverages that are linked to a particular numerical model such as [MODFLOW](#). Once a conceptual model has been defined, coverages can be created beneath the conceptual model. The properties available in the *Coverage Setup* dialog depend on the model associated with the conceptual model.

The conceptual model tools are included with all [paid editions](#) of GMS.

Conceptual Model Properties

Each conceptual model has a name and a numerical model. Then depending on the numerical model other properties can be assigned in the *Conceptual Model Properties* dialog. The dialog is reached right-clicking on the Project Explorer and creating a new conceptual model. The dialog can be accessed on an existing conceptual model by right-clicking on the conceptual model in the Project Explorer and selecting **Properties**.

The following is a list of the numerical model and additional properties that are assigned to the conceptual model.

MODFLOW – The flow package can be LPF, BCF, or HUF for a [MODFLOW](#) conceptual model. Optionally, transport can be included with the MODFLOW conceptual model. If transport is turned on then the transport model must be selected ([MT3DMS](#), [RT3D](#), [SEAM3D](#)), and species and/or reaction parameters need to be entered.

FEMWATER – A [FEMWATER](#) conceptual model has the option of simulating flow and/or transport.

MODAEM – No additional properties are set for a [MODAEM](#) conceptual model.

WASH123D – A WASH conceptual model has the option of simulating 3D subsurface flow and/or 3D subsurface transport and/or 2D overland flow. If the 3D subsurface transport option is turned on, then chemicals must be created.

SEEP2D – No additional properties are set for a [SEEP2D](#) conceptual model.

Horizons – No additional properties are set for a **Horizon** conceptual model.

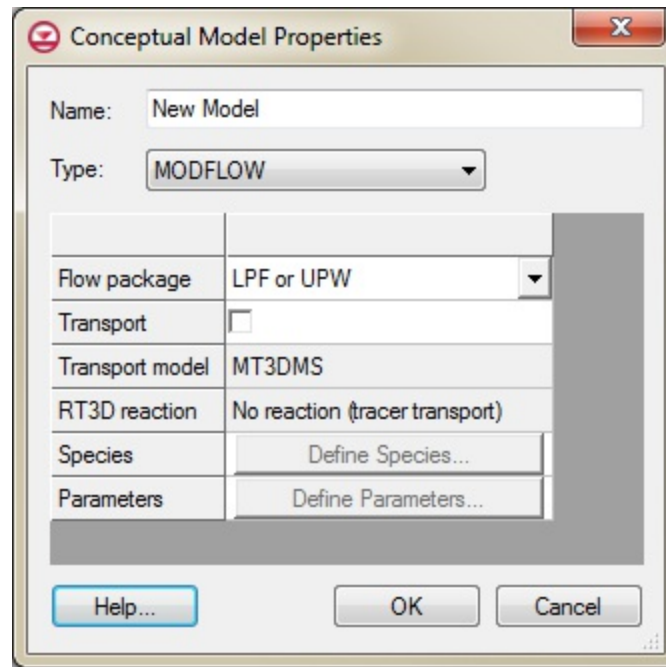

The Conceptual Model Properties dialog

Feature Object Display Options

The properties of all feature object and coverage data that GIS displays on the screen can be controlled through the *Map* tab of the *Display Options* dialog. This dialog is opened by right-clicking on the "Map Data" entry in the [Project Explorer](#) and selecting the **Display Options** command. It can also be accessed from the *Display* menu or the **Display Options**  macro. The objects on the left of the dialog are common to all coverages, regardless of the coverage type, and are always available in the *Display Options* dialog. The options on the right of the dialog depend on the coverage type. The following table describes the general display options available for the Map module.



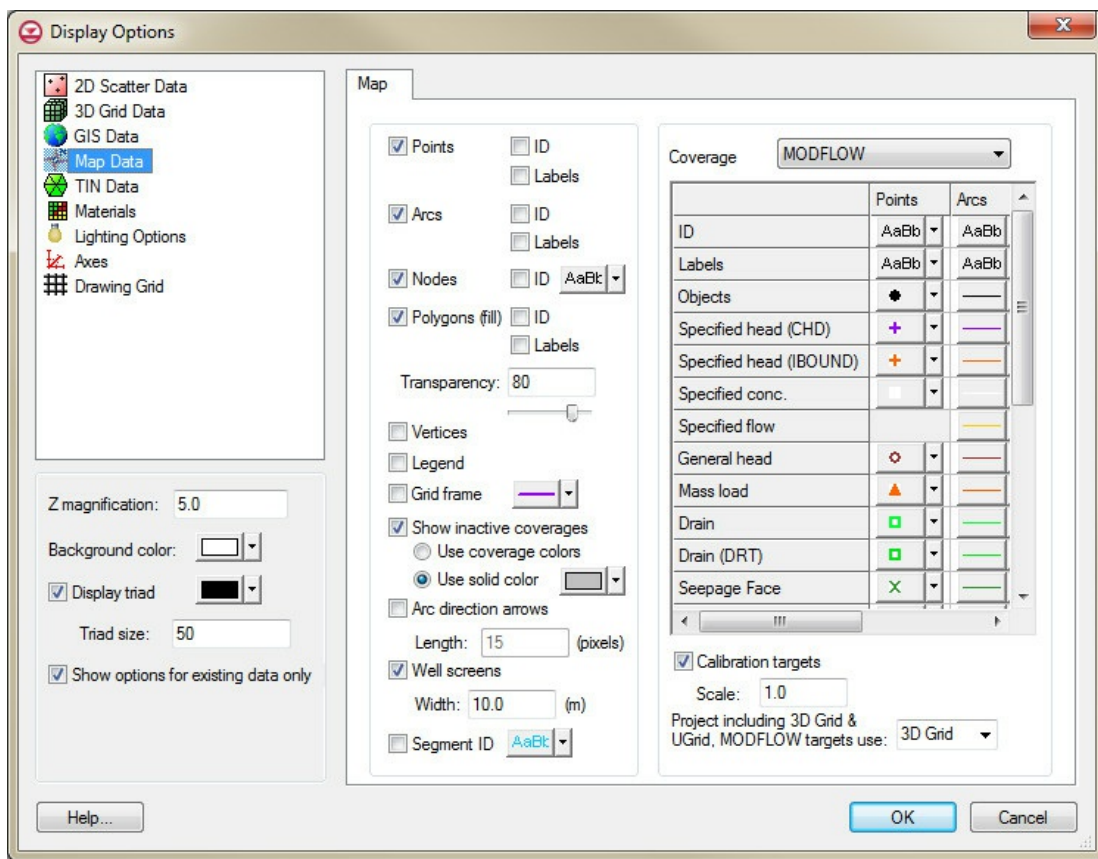







Display Option	Description
ID	If this option is selected, the ID of each of the feature objects is displayed next to the object. The graphical attributes of the text used to display the IDs are edited using the fields on the right side of the dialog.
Labels	If this option is selected, the name of points is displayed next to the object. The graphical attributes of the text used to display the Labels are edited using the fields on the right side of the dialog.
Points	This option displays points. The graphical attributes of the points (symbol, color, size, etc.) depend on the coverage type and are edited using the fields on the right side of the dialog.
Nodes	This option displays nodes. The graphical attributes of the nodes (symbol, color, size, etc.) depend on the coverage type and are edited using the fields on the right side of the dialog.
Vertices	This option displays the vertices of arcs. A small dot is placed on the arcs at the location of each of the vertices. The color of the vertices is the same as the color of the arcs.
Arcs	This option displays arcs. The graphical attributes of the arcs (color, line style, thickness, etc.) depend on the coverage type and are edited using the fields on the right side of the dialog.
Polygons (fill)	If this option is selected, polygons are displayed filled. The graphical attributes of the polygons (fill color) depend on the coverage type and are edited using the fields on the right side of the dialog. The Polygon fill can also be specified as an attribute. Transparency can also be set on the polygon fill using the edit box below the option.
Legend	The <i>Legend</i> item displays a legend listing each of the feature object types being displayed and showing what graphical attributes (symbol, line style, fill color and pattern) are being used to display each type.
Grid frame	This option is used to turn on and off the display of the Grid Frame.
Show inactive coverages	When several coverages are present, the display of coverages can become confusing. The user can choose to not display inactive coverages or change the color attributes on inactive coverages Each of the feature objects in a coverage has a set of display options (color, line style, etc.) that can be edited in the <i>Display Options</i> dialog. However, these colors are only used to display the objects in the active coverage. All of the objects in the inactive coverages are displayed using either Coverage colors or the Inactive coverage color depending on the selected option.
Arc direction arrows	This option controls the display of an arrow which shows the arc direction . The pixel length of the arrow can be specified.
Well screens	This options controls the display of the well screens. The width of the well screen can be adjusted in the Width edit field below the toggle.
Segment ID	This option controls the display of the segments IDs. The font color and size for the segment can also be adjusted.
Calibration targets	This option controls the display of the calibration targets used in the model calibration process. Calibration targets are drawn next to their corresponding map data (point, arc, polygon). The calibration target is drawn such that the height of the target is equal to twice the confidence interval (+ interval on top, - interval on bottom). The <i>Scale</i> edit field allows the user to change the general length and width of the targets independent of the range of the active dataset.
MODFLOW targets	This option controls which active dataset (either the active 3D Grid dataset or the active UGrid dataset) displays of the MODFLOW calibration targets.



The Display Options dialog showing the Map tab.

Feature Object Tool Palette



Several tools are provided in the tool palette for creating and editing feature objects. These tools are located in the dynamic portion of the [tool palette](#) and are only available when the Map module is active. The table below describes the feature object tools.

Tool	Tool Name	Description
	Select Tool	Generic selection tool that selects existing feature objects, including: nodes, vertices, arcs, and polygons. A selected object can be deleted, moved to a new location, or operated on by one of the commands in the Feature Objects menu. The coordinates of selected points/nodes can be edited using the Edit Window . Double-clicking on a object with this tool brings up that <i>Objects Attribute</i> dialog.
	Select Point/Node	Selection tool that will only select existing points or nodes. A selected point/node can be deleted, moved to a new location, or operated on by one of the commands in the Feature Objects menu. The coordinates of selected points/nodes can be edited using the Edit Window . Double-clicking on a point or node with this tool brings up the <i>Point</i> or <i>Node Attribute</i> dialog.
	Select Vertex	Selection tool that will only select existing vertices on arcs. Once selected, a vertex can be deleted, moved to a new location, or operated on by one of the commands in the Feature Objects menu. The coordinates of a selected vertex can be edited using the Edit Window .
	Select Arc	Selection tool that will only select existing arcs to perform operations such as deletion, redistribution of vertices, or building polygons. Double-clicking on an arc with this tool brings up the <i>Arc Attributes</i> dialog.
	Select Arc Group	Selection tool that is used to select an arc group to assign attributes or to display the computed flux on the arc group. An arc group is created by selecting a set of arcs and selecting the Create Arc Group command. An arc group is deleted by selecting the arc group and selecting the <i>Delete</i> key or by selecting the Delete command in the <i>Edit</i> menu. Deleting an arc group does NOT delete the underlying arc objects.
	Select Polygon	Selection tool that will only select previously created polygons for operations such as deletion, assigning attributes, etc. A polygon is selected by clicking anywhere in the interior of the polygon. Double-clicking on a polygon with this tool brings up the <i>Table Attributes</i> dialog.
	Select Grid Frame	Selection tool used to select grid frames, allowing for the editing of the grid frame. Once the grid frame is selected, the placement and size of the grid frame can be edited by clicking on small rectangles and dragging.
	Create Point/Node	Creates new points. A new point is created for each location the cursor is clicked on in the Graphics Window. Once the point is created, it can be repositioned or otherwise edited with the Select Point/Node tool.
	Create Vertex	Creates new vertices along existing arcs. This is typically done to add more detail to the arc. A new vertex is created for each location the cursor is clicked on in the Graphics Window that is within a given pixel tolerance of an existing arc. Once the vertex is created, it can be repositioned with the Select Vertex tool.
	Create Arc	<p>Creates new arcs. An arc is created by clicking once on the location where the arc is to begin, clicking once to define the location of each of the vertices in the interior of the arc, and double-clicking at the location of the end node of the arc.</p> <p>As arcs are created, it is often necessary for the beginning or ending node of the arc to coincide with an existing node. If the user clicks on an existing node (within a given pixel tolerance) when beginning or ending an arc, that node is used to define the arc node as opposed to creating a new node. If the user clicks on a vertex of another arc while creating an arc, that vertex is converted to a node and the node is used in the new arc. If the user clicks within a given tolerance of an arc edge, a new node is inserted in the arc. If the user clicks on an existing point while creating an arc, the point is converted to a vertex, unless it is the beginning or ending location of an arc, in which case it is converted to a node.</p> <p>While creating an arc, it is common to make a mistake by clicking on the wrong location. In such cases, hitting the <i>Backspace</i> key backs up the arc by one vertex. The <i>ESC</i> key can also be used to abort the entire arc creation process at any time.</p>

Coverages

[Feature Objects](#) in the Map module are grouped into coverages. Coverages are grouped into [conceptual models](#).

A coverage is similar to a layer in a CAD drawing. Each coverage represents a particular set of information. For example, one coverage could be used to define recharge zones and another coverage could be used to define zones of hydraulic conductivity. These objects could not be included in a single coverage since polygons within a coverage are not allowed to overlap and recharge zones will typically overlap hydraulic conductivity zones.

Coverages are managed using the [Project Explorer](#). Coverages are organized below conceptual models. When GMS is first launched, no coverage exists. If no coverage exists and the user creates [feature objects](#) then a new coverage will automatically be created. When multiple coverages are created, one coverage is designated the "active" coverage. New feature objects are always added to the active coverage and only objects in the active coverage can be edited. The figure below shows several coverages in the [Project Explorer](#). The active coverage is displayed with a color icon  and bold text. Inactive coverages will have a grayed out icon . A coverage is made the active coverage by selecting it from the Project Explorer. In some cases it is useful to hide some or all of the coverages. The visibility of a coverage is controlled using the check box next to the coverage in the Project Explorer.

A new coverage can be created by right-clicking on a folder or conceptual model and selecting the **New Coverage** command in the pop-up menu.

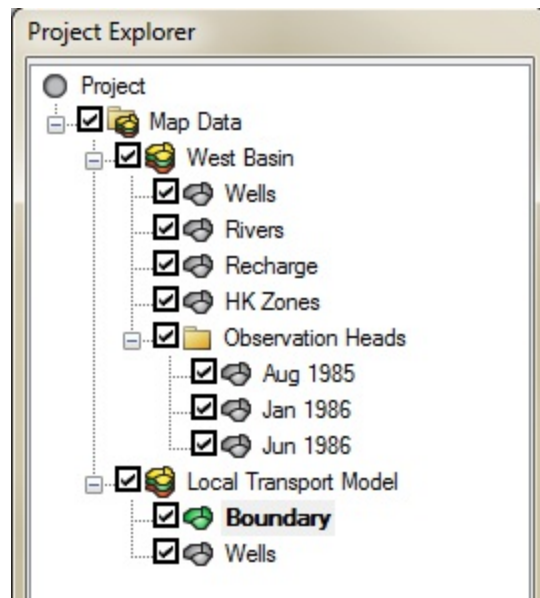

Example of the tree map in the Project Explorer

Coverage Right-Click Commands

Right-clicking on a coverage brings up a menu with the following options:

- **Delete** – Removes the selected coverage from the GMS project. Once deleted the coverage will have to be either loaded into GMS again if it came from a file or the coverage will have to be rebuilt.
- **Duplicate** – Creates a copy of the selected coverage in the Project Explorer. The duplicate coverage will have the word "Copy of..." affixed to the name of the copied coverage. Additional duplicates will have a number affixed to the name if the copied coverage is not renamed.
- **Rename** – Assigns a new name to the selected coverage.

Coverage Setup

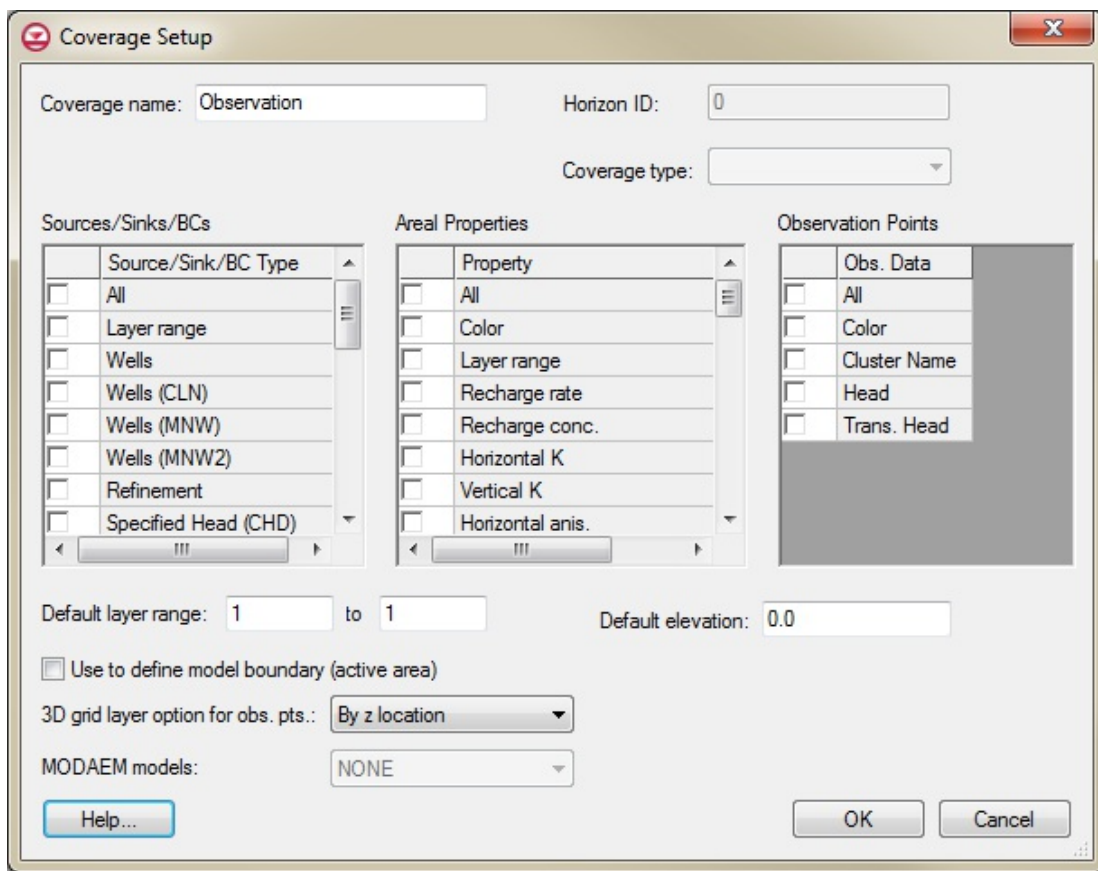

Example of the Coverage Setup dialog

The **Coverage Setup** command brings up the *Coverage Setup* dialog. This dialog controls the properties that are assigned to feature objects. The feature object properties have been divided into 3 general categories: *Sources/Sinks/BCs*, *Areal Properties*, and *Observation Points*. Under the *Sources/Sinks/BCs* the user can select which source/sinks he would like to include in the coverage (like wells, rivers, drains, etc). *Areal Properties* includes recharge, ET, hydraulic conductivity, and other properties that are assigned to polygonal zones. *Observation Points* control which datasets have associated observation data.

Note about the "Layer range" boundary condition option: the "Layer range" option can be used to apply a boundary condition over one or more layers. When turned on, three column fields are added to the boundary condition attribute table including "Auto assign layer", "From layer", and "To layer".

The *Coverage type* is used for WASH123D conceptual models to set the coverage to be a 3D or a 2D coverage.

The *Default layer range* is used with MODFLOW conceptual models to default the "from

layer"/"to layer" assignments for boundary conditions.

The *Use to define model boundary* toggle is used with MODFLOW and MODAEM. This means that the polygons in this coverage are used to define the active area of the model. For no flow boundary cells a majority of the cell has to be with a polygon for it to be active. For specified head cells if any portion of the cell is inside a boundary polygon then it is activated.

3D grid layer option for obs. pts

The *3D grid layer option for obs. pts.* is used to set the input option for observations associated with MODFLOW conceptual models. The MODFLOW observation package can handle observations that include multiple cells. Three options are available for determining which layer the observation point will be located:

- by z location – When the "by z location" option is selected, the computed value for the observation point (that will be compared with the observed value) will be taken from the cell that corresponds with the elevation value assigned to the observation point.
- by layer number – If selecting the "by layer number" option in the coverage setup, the computed value will be taken from the cell that corresponds to the layer that is specified in the observation point coverage properties.
- Use well screen – This option may be used when the model includes wells with screens. GMS finds the cell or cells that intersect the screened interval the user has entered.

The *Default elevation* field can be used to define the initial Z elevation of new objects created in a coverage. By assigning a different elevation to each of the coverages, the coverages can be displayed as a stack of layers in oblique view.

Feature Object Attribute Table

All feature object properties are edited using a single spreadsheet. This makes it possible to cut and paste feature object data using the clipboard and it makes it easier to edit entire

columns of data at once. Filters at the top of the dialog control what type of objects are displayed.

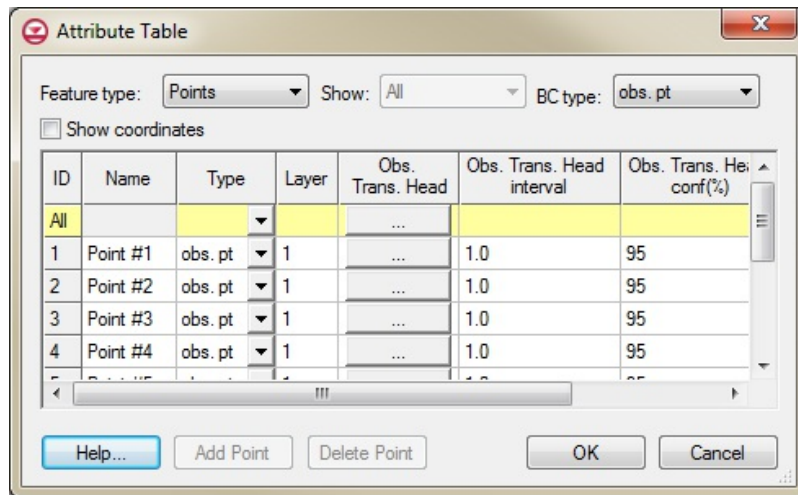









The screenshot shows a dialog box titled "Attribute Table" with a table of feature object attributes. The table has columns for ID, Name, Type, Layer, Obs. Trans. Head, Obs. Trans. Head interval, and Obs. Trans. Head conf(%). The first row is highlighted in yellow and labeled "All". Below it are four rows for "Point #1" through "Point #4", each with a Type of "obs. pt", Layer of "1", and Obs. Trans. Head of "...". The Obs. Trans. Head interval is "1.0" and the Obs. Trans. Head conf(%) is "95".

ID	Name	Type	Layer	Obs. Trans. Head	Obs. Trans. Head interval	Obs. Trans. Head conf(%)
All				...		
1	Point #1	obs. pt	1	...	1.0	95
2	Point #2	obs. pt	1	...	1.0	95
3	Point #3	obs. pt	1	...	1.0	95
4	Point #4	obs. pt	1	...	1.0	95

Example of the feature object Attributes Table

Map To Submenu

Coverages can be mapped to other geometric objects or numerical models by selecting the corresponding command from the *Map to* submenu. Options include:

-  – Creates a TIN using each polygon in the coverage.
-  – Creates a 2D Mesh on the interior of all of the polygons in the current coverage.
-  – Opens the "Create Grid" dialog.
-  – Creates a UGrid from feature objects.
-  – Creates a scatter point set from the points and nodes and vertices of the current coverage.
-  – Converts a conceptual model to a MODFLOW numerical model.
-  – Converts a conceptual model to a FEMWATER numerical model.
-  – Converts a conceptual model to a MT3DMS numerical model.
-  – Converts a conceptual model to a SEEP2D numerical model.

Merge Coverage

Multiple coverages can be merged in a new coverage. Do this by selecting two or more coverages using the *Shift* key, then right-click on the coverages and select the **Merge** command. A new coverage will be created in the Project Explorer. This merged coverage will contain all properties and feature objects that existed on each coverage used to create the merged coverage.

See also

- [Conceptual Model](#)
- [Feature Objects](#)

Grid Frame

A grid frame is an outline showing where a grid will be created. The grid frame can be used to create a grid at a particular location, size and orientation. The *Feature Objects* | **New Grid Frame** command is used to create the grid frame. When the **Map** → **3D Grid** command is selected, the grid will be created using the grid frame.

Grid Frame Properties

The **Grid Frame**  tool can be used to move, size and rotate the grid frame. Double-clicking on the grid frame will bring up the *Grid Frame Properties* dialog which can also be used to move, size and rotate the grid frame. The dialog is also reachable by right-clicking on the grid frame object in the Project Explorer and selecting **Properties**.

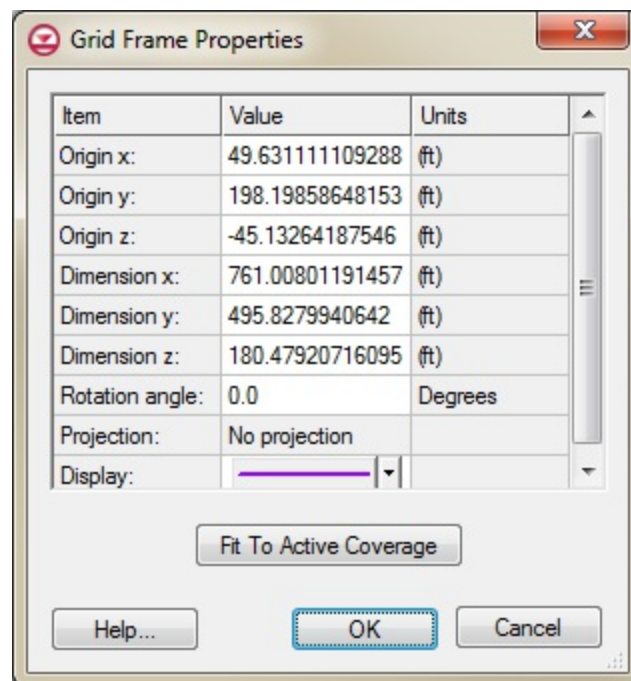

The GMS Grid Frame Properties dialog

The dialog has the following options:

- *Origin x, y, and z* – Shows the starting location of the grid frame. This is typically in the

lower left corner of the grid frame. Edit the fields to move the origin.

- *Dimension x, y, and z* – Shows the height, width, and depth of the grid frame. Can be edited.
- *Rotation angle* – Changes the angle of the grid frame by rotating from the original point.
- *Display* – Can be clicked on to bring up a *Line Properties* dialog. The color and width of the line can be changed.
- **Fit to Active Coverage** – Changes the dimension and origin of the grid frame so that all feature objects in the active map coverage fit within the grid frame.

Displaying the Grid Frame

The display of the grid frame can be turned on or off using the checkbox next to the  grid frame in the [Project Explorer](#) or by using the *Grid Frame* option in the [Feature Objects Display Options](#) dialog.

Clean Command

The **Clean** command, in the *Feature Objects* menu, is used to fix errors in feature object data. The **Clean** command only applies to the active coverage. Selecting the **Clean** command brings up the *Clean* dialog. The clean options are as follows:

- *Snap Nodes* – Any two nodes (or points) separated by a distance which is less than the specified distance tolerance are combined to form a single node.
- *Snap Selected Nodes* – This option is the same as the previous option but only the selected nodes are checked. When this option is checked, the user will be prompted to select a snapping point. Click on the graphics window to indicate the snapping point.
- *Intersect Arcs* – All arcs are checked to see if they intersect. If an intersection is found, a node is created at the intersection and the arcs are split into smaller arcs.
- *Intersect Selected Arcs* – This option is the same as the previous option but only selected arcs are checked for intersections.
- *Remove Dangling Arcs* – A check is made for dangling arcs (arcs with one end not connected to another arc) with a length less than the specified minimum length. If any are found, they are deleted.

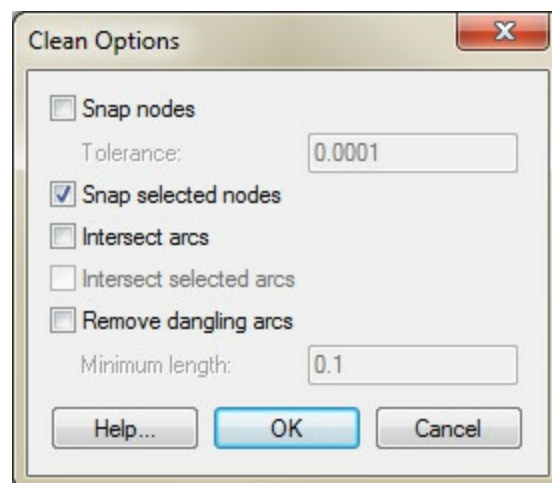

Clean command dialog

Temporal Discretization

Many of the parameters associated with [feature objects](#) can be specified as either constant or transient values. Transient values are defined as a simple list of time/data pairs using the [XY Series Editor](#). The time series represents a piece-wise linear curve indicating how the parameter varies with time. When the **Map** → **MODFLOW** command is selected, these curves must undergo temporal discretization. Temporal discretization is a process of converting general time series into discrete values that apply over specific time ranges (stress periods).

Transient parameters associated with feature objects are stored in an [xy series](#). An xy series is a general-purpose object used in GMS to represent curves of data (in this case a time series). An xy series is manipulated by GMS with regards to feature objects in three different ways: extrapolation, interpolation, and integration.

Extrapolation

Because the user is free to enter any time values for the x parameter of an xy series, it is possible that the xy series as entered does not cover the same time range as the [stress periods](#). In this case it may be necessary to extrapolate a value for the xy series at a time before or after the first or last entered value. In GMS the simplest approach has been used. If a value is required for a time previous to the times defined by the xy series, the first value is used. Likewise for a time that is later than the all of the times in the xy series, the last value is used. Since this behavior might hide an error in the input parameters, GMS will warn the user if any xy series does not cover the time range defined by the stress periods.

Interpolation

It is also sometimes necessary to create an xy series that is a composite of two other xy series. This is the case when obtaining transient values for an intermediate point along an arc segment that has differing transient parameters at both nodes at the ends of the arc. To

perform this type of interpolation, a new xy series is constructed that is the union of the x times from the two original series. The y-values that correspond to the time step in each of the series are used to obtain a new y value for the intermediate point:

$$F = (1 - h_1)y_1 + (1 - h_2)y_2$$

Where F is the y-value along the new xy series, y_1 and y_2 are the two node xy series and h_n is the interpolation weighting parameter.

As an example, when one node of an arc has a constant parameter and the other has a transient parameter, the constant parameter is converted into an xy series with only one point. By using the extrapolation assumption above, it is then possible to perform a transient interpolation using two transient series.

Integration

[MODFLOW](#) and [MT3DMS](#) both use the concept of [stress periods](#) to define the times that stresses may be applied. A stress period is a time interval during which all external stresses are constant. Because an xy series is not constrained to be constant over a time interval, it is necessary to obtain a representative value from the xy series that will approximate this condition.

GMS uses integration of the curve defined by the xy series to obtain the average value over the stress period. This average value is then assigned to the stress period.

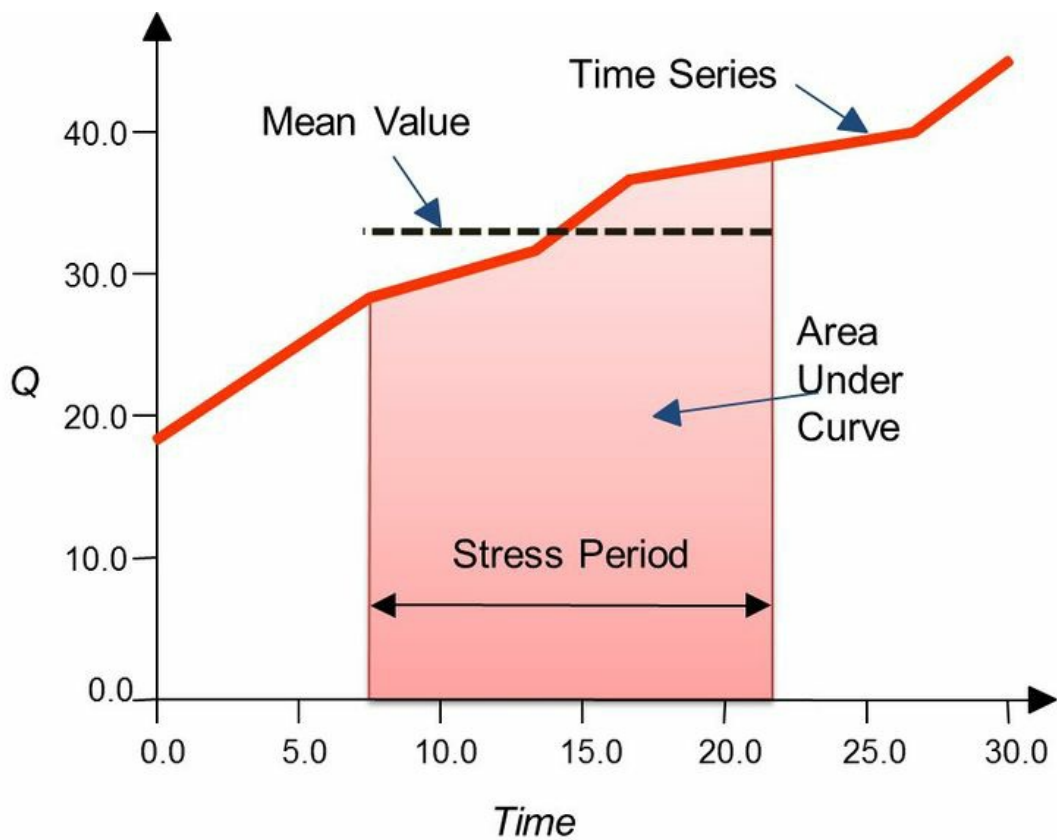

Time Units

When entering a time series in the [Map module](#) using the [XY Series Editor](#), a user can use relative times (i.e., 0.0, 3.2, 5.4 etc.), or dates/times (1/1/2004 12:00:00 AM, 2/13/2004 2:01:00 PM etc.).

Map to Models

To make modeling easier, GMS provides commands to directly convert a map module to certain models.

Map to Model Dialog

The *Map* → *Model* dialog provides a few options for how feature objects in Map module will be converted.

- *Active coverage only* – Only feature objects in the current active coverage will be converted to the model.
- *All applicable coverages* – GMS will examine coverages and convert only feature objects that can be used by the current active model. Coverages with attributes and feature objects that cannot be used by the active model will be ignored.
- *All visible coverages* – All feature objects in coverages that are displayed in the Graphics Window will be converted to the active model.
- *Constant value throughout dataset time step (step function)*
- *Interpolate between dataset time steps (non-step function)*

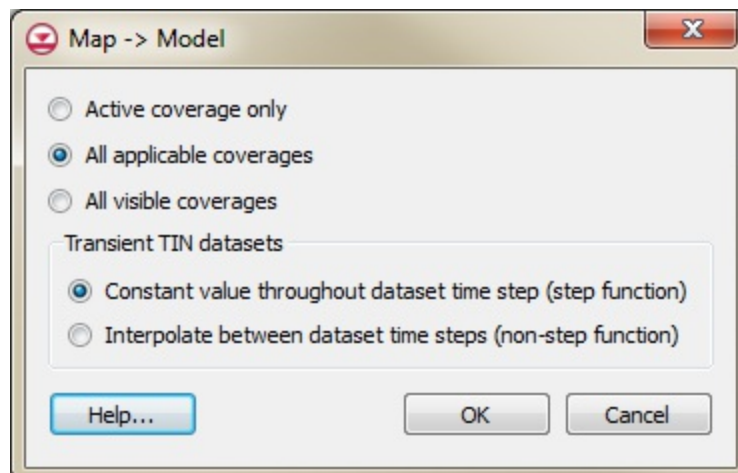

The Map → Model dialog

Map to MODFLOW

See [Map to MODFLOW](#)

Map to FEMWATER

Once the 3D mesh is constructed, the final step in converting the FEMWATER conceptual model to a mesh-based numerical model is to select the **Map** → **FEMWATER** command in the *Feature Objects* menu. This command assigns the wells, boundary conditions, and recharge zones assigned to the points, arcs, and polygons in the conceptual model to the nodes and element faces of the 3D mesh. At this point, the basic analysis options (steady state vs. transient, output control, material properties, etc.) must still be assigned using the tools in the *FEMWATER* menu. Once these basic options have been assigned, the model can be saved and FEMWATER can be launched.

Map to MT3DMS

After the [conceptual model](#) is constructed, the **Map** → **MT3DMS** command can be used to convert the conceptual model to an [MT3DMS numerical model](#). Before the **Map** → **MT3DMS** command can be selected, the MT3DMS data must be initialized. The MT3DMS data are initialized with the following steps

1. Switch to the [3D Grid module](#)
2. Select the **New Simulation** command from the *MT3DMS* menu.
3. Open the [Basic Transport Package dialog](#) and set up the [stress periods](#) to use in the simulation.

Once the MT3DMS data are initialized, the **Map** → **MT3DMS** command becomes undimmed and can be selected.

Because MT3DMS already assumes a default concentration of zero for an unspecified point source/sink, GMS does not create a source/sink if the concentration for the feature object has been specified as a constant value of zero.

Related Topics

- Map to MODFLOW

Map to Modules

Feature objects in the Map module can be converted to geometries in other modules using the following commands.

Arc → Cross Sections

The default method for generating cross sections through solids, 3D meshes, or 3D grids is to interactively enter a line or a polyline in the Graphics Window while the **Make Cross Section** tool is active ([Solid module](#), [3D Grid module](#), [3D Mesh module](#)). This line is then projected perpendicular to the screen (parallel to the viewer's viewing angle) and is intersected with the 3D objects to generate the cross section. In some cases, it is useful to precisely locate the cross section. Furthermore, it is often necessary to repeatedly generate a cross section at the same location. In such cases, the **Arcs → Cross Sections** command can be used to precisely control the location of a cross section.

When the **Arcs → Cross Sections** command is selected, the *Arcs → Cross Sections* dialog appears. The top part of the dialog is used to specify which of the arcs are to be used to create the cross sections. Either all of the arcs are used or only the selected arcs. Since cross sections can be cut through any 3D object, the items in the lower section of the dialog are used to designate which of the 3D objects will be used to cut the cross sections. If one of the types listed does not currently exist, the corresponding item is dimmed.

When the **OK** button is selected, a cross section is constructed for each of the designated arcs. As is the case when the **Make Cross Section** tool is used, the cross sections are constructed by projecting the arcs parallel to the viewing angle. For example, to create vertical cross sections, the image should be in plan view prior to selecting the **Arcs → Cross Sections** command.

Map → TIN

The **Map → TIN** command creates a TIN using each polygon in the coverage. Vertices and

nodes in the polygons are triangulated using the triangulation algorithm. The algorithm assumes that each of the vertices being triangulated is unique in the xy plane.

Map to 2D Mesh

Once a set of feature objects has been created for a SEEP2D or a FEMWATER conceptual model, the **Map** → **2D Mesh** command can be used to generate a 2D finite element mesh from the objects. The **Map** → **2D Mesh** command creates a 2D mesh on the interior of all of the polygons in the current coverage. The figure below shows a cross section of a dam built using the [feature objects](#) in the Map module. The second figure shows a 2D Mesh created from the polygons.

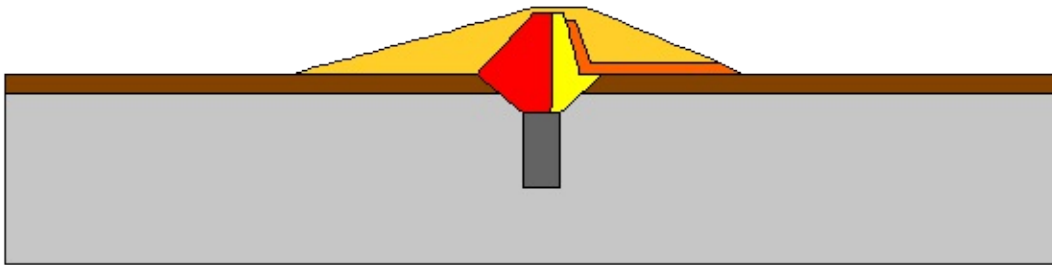

Cross section of a dam built with arcs and polygons in the map module

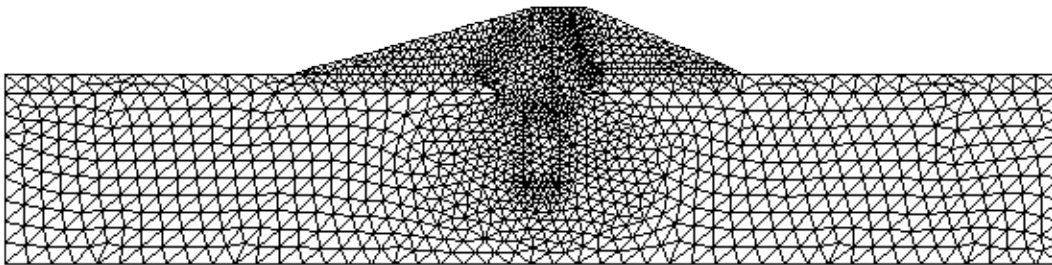

*2D mesh created from map objects using **Map** → **2D Mesh** command*

Map to 2D Grid

The **Map** → **2D Grid** command is used to construct a 2D grid using the feature objects in a 2D grid coverage. When the **Map** → **2D Grid** command is selected, the *Create Finite Difference Grid* dialog appears. If a grid frame has been defined, the size and location of the grid frame are used to initialize the fields in the *Create Finite Difference Grid* dialog. In most cases, these values will not need to be changed and the user can simply select the OK button to create the grid. If a grid frame has not been defined, the size and location of the grid are initialized so that the grid just surrounds the currently defined feature objects. If desired, the grid dimensions can be edited prior to selecting the **OK** button to create the grid.

If one or more refine points are defined in the conceptual model, the number of rows and columns in the grid will be automatically determined when the grid is created. Thus, these fields cannot be edited by the user and will be dimmed. If refine points are not defined, the user must enter the number of rows and columns.

Map to 3D Grid

Once the feature object coverages defining a conceptual model have been completely defined, the conceptual model is ready to be converted to a numerical model. The first step in this conversion process is to create a grid using the **Map** → **3D Grid** command. Typically, the **Grid Frame** command is used prior to this command to define the location and dimensions of the grid.

When the **Map** → **3D Grid** command is selected, the *Create Finite Difference Grid* dialog appears. If a grid frame has been defined, the size and location of the grid frame are used to initialize the fields in the *Create Finite Difference Grid* dialog. In most cases, these values will not need to be changed and the user can simply select the **OK** button to create the grid. If a grid frame has not been defined, the size and location of the grid are initialized so that the grid just surrounds the currently defined conceptual model. Once again, in most cases, no changes will need to be made and the user can typically immediately select the **OK** button to create the grid.

If one or more refine points are defined in the conceptual model, the number of rows and columns in the grid will be automatically determined when the grid is created. Thus, these

fields cannot be edited by the user and will be dimmed. If refine points are not defined, the number of rows and columns must be entered.

Refine Points

Refine attributes are assigned to [points](#) or [nodes](#) and are used to automatically increase the grid density around a point when the [grid is constructed](#). Although refine attributes may be associated with any point or node, they are usually assigned in conjunction with wells.

Map to 2D Scatter Points

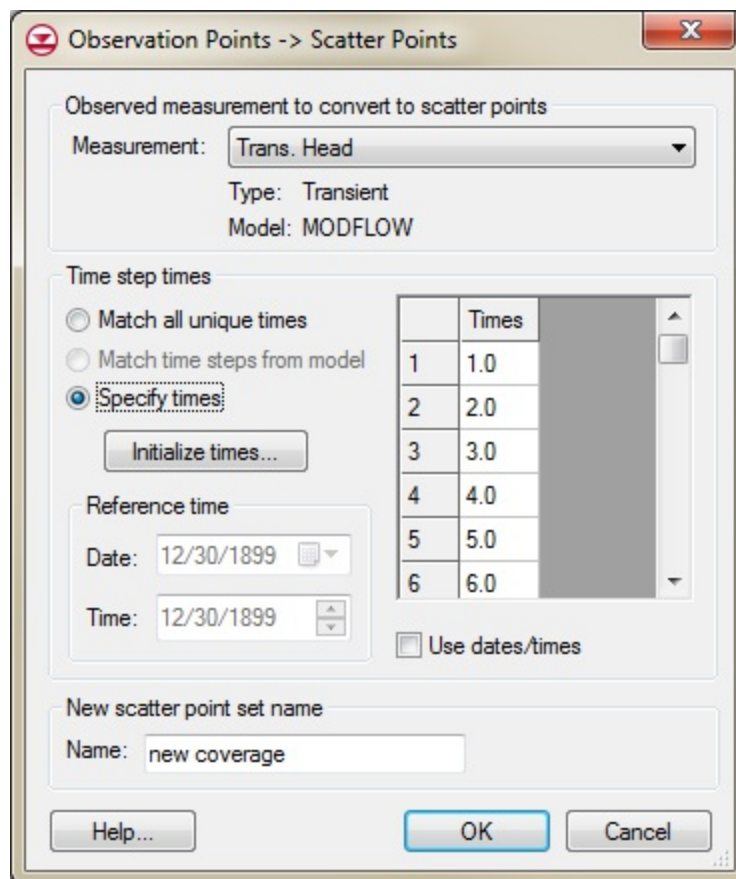

Example of the Observation Points → Scatter Points dialog

The **Map → 2D Scatter Points** command creates a scatter point set from the points and nodes and vertices of the current coverage. The process is different for observation coverages and non-observation coverages.

Non-observation Coverages – With non-observation coverages, a single elevation dataset

is created for the 2D scatter points representing the Z location of all the points, nodes and vertices.

Observation Coverages – With observation coverages, the *Observation Points* → *Scatter Points* dialog appears. This dialog allows creating a dataset for the 2D scatter points from one of the measurements associated with the observation points.

Measurement – A dataset is created for the 2D scatter points from the measurement selected in the dialog. The model associated with the selected measurement (if any) is shown, along with whether the measurement is steady state or transient.

Time Step Times – This section of the dialog is only available if the selected measurement is transient. It allows the user to define the number of time steps, and the time step times to be created for the scatter point dataset.

Match all unique times – The *Match all unique times* option gets the set of unique times from the XY series of all the observation points. This is the union of all the times. If some XY series use dates/times and others don't, this option won't be available. Otherwise, the times in the spreadsheet will be displayed as either dates/times or relative times depending on the XY series. The spreadsheet will not be editable. The Use dates/times toggle will be unavailable but set according to whether the observation point XY series use dates/times or not. The *Reference time* section will be unavailable, but if the XY series use dates/times, the minimum time will be used as the reference time for the scatter point dataset.

Match time steps from model – The Match time steps from model option will only be available if the measurement is associated with a model, and the model is transient. If so, this will be the default choice and GMS will get the times to display in the spreadsheet from the stress period and time step info for the model. The spreadsheet will not be editable. The *Use dates/times* toggle will be unavailable but set according to whether the model uses dates/times or not. The *Reference time* section will be unavailable, but if the model uses dates/times, the model reference time will be used as the reference time.

Specify times – The spreadsheet of times will be editable with this option. The user can then copy and paste times from another program such as a spreadsheet. Also, the **Initialize Times** button becomes available to bring up a dialog that can be used to create times at a specified interval. If the user selects the *Use dates/times* toggle, the *Reference time*

section will become available and the times in the spreadsheets will be displayed as dates/times.

Map to 3D Scatter Points

The **Map → 3D Scatter Points** command was introduced in GMS version 8.3. This command works exactly like the **Map → 2D Scatter Points** command except that 3D scatter points are created. One use of the **Map → 3D Scatter Points** command is to create scatter points from map data that can then be converted into [MODPATH starting locations](#).

5.11. GIS Module

GIS Module



The GIS module allows manipulating ESRI type GIS data, such as shapefiles. If there is a license of ArcView 8.x or higher on the computer where GMS is installed, there are additional features available in the GIS module. It's not necessary to have an ArcView 8.x license installed to access the basic features.

The following table shows what features are available with and without a license of ArcView 8.x.

Feature	With ArcView	Without ArcView
Efficient management of large datasets	X	X
Graphical selection of features	X	X
Conversion of selected GIS objects to GMS feature objects	X	X
Viewing attribute tables	X	X
Joining additional attribute tables based on a key field	X	X
Display like ArcView	X	X
Display in a simplified, single color	X	X
Support for shapefiles	X	X
Support for coverages, geodatabases, images, CAD, grids	X	
Selection queries	X	
Symbology	X	

The GIS module is included with all [paid editions](#) of GMS. GIS data can be imported using the Community Edition, but the GIS tools are disabled.

GIS Display Options

The properties of all GIS data that GMS displays on the screen can be controlled through the *Shapefiles* tab of the *Display Options* dialog. This dialog is opened by right-clicking on the GIS Data  entry in the [Project Explorer](#) and selecting the **Display Options** command. It can also be accessed from the *Display* menu or the **Display Options**  macro. The following table describes the display options available for the GIS module.

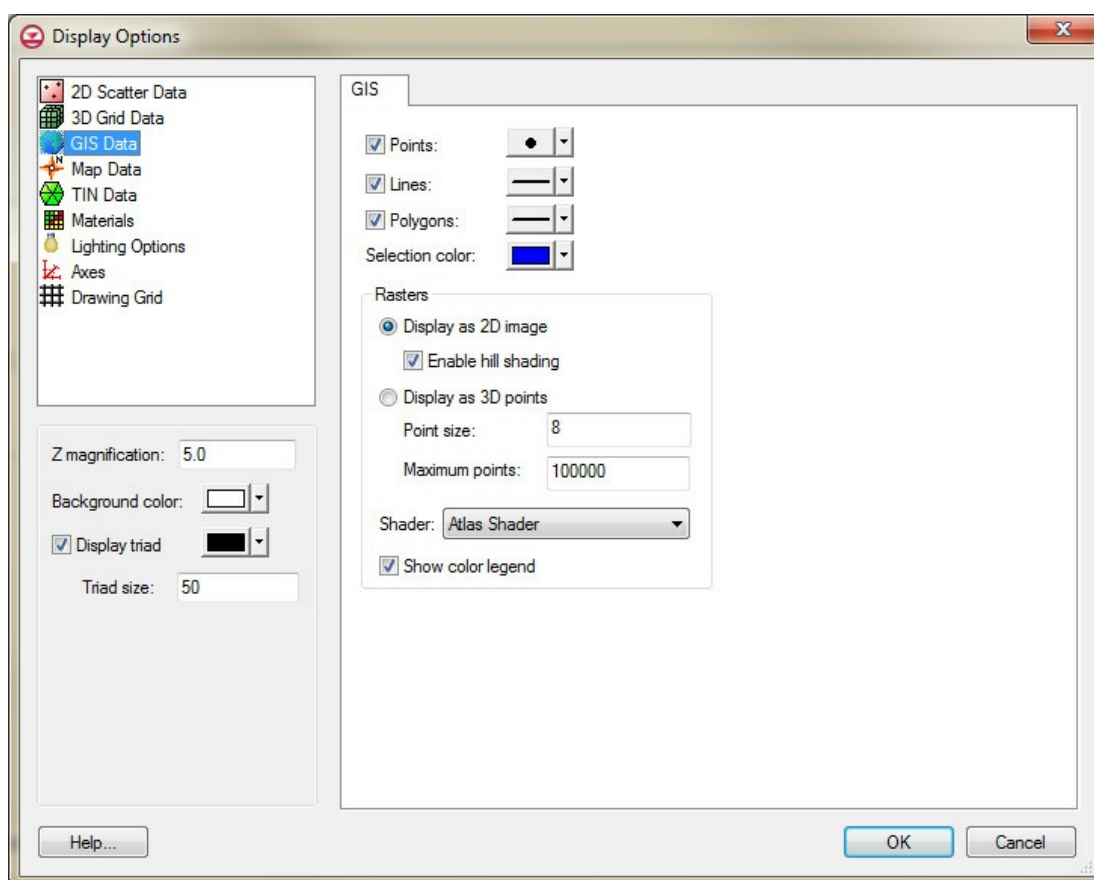

Display Option	Description
Points	Controls the display of points in shapefiles in the Graphics Window. The size and color of the points can be adjusted using the button to the right of the <i>Points</i> option.
Lines	Controls the display of lines in shapefiles in the Graphics Window. The line type, width, and color can be adjusted using the button to the right of the <i>Lines</i> option.
Polygons	Controls the display of polygons in shapefiles in the Graphics Window. The polygon line type, width, and color can be adjusted using the button to the right of the <i>Polygons</i> option.
Selection color	Controls the selection color used when GIS shapefile objects are selected in the Graphics Window.





The Display Options dialog showing the GIS tab.

GIS Tool Palette

The following tools are active in the dynamic portion of the [tool palette](#) whenever the GIS module is active. Only one tool is active at any given time. The action that takes place when the user clicks in the Graphics Window with the cursor depends on the current tool. The following describes the tools in the GIS tool palette.

Tool	Tool Name	Description
	Select Features	The Select Features tool is used to select feature objects in the Graphics Window. This tool is only available if ArcView is installed locally on the user's desktop.
	Identify	The Identify tool is used to select GIS objects and display information relating to that object in an <i>Identify Results</i> dialog. This tool is only available if ArcView is installed locally on the user's desktop.
	Select Elements	The Select Elements tool is used to select shape objects in the Graphics Window.

Rasters

DEMs (digital elevation models), and [images](#) that include elevation data such as a [GeoTIFF](#), are referred to as "rasters". Using the third-party software [Global Mapper](#), GMS supports a large number of DEM formats. After importing, DEMs are listed under " GIS Layers" in the Project Explorer along with other images. The raster icon  is different from the image icon  to indicate it includes elevation data. The values at the pixels can represent a wide variety of data, including (but not limited to) concentrations, elevations, or flow rates.

Importing Rasters

Rasters can be imported by simply opening the file(s) or dragging and dropping the file(s) into the GMS window. Multiple files can be imported at once. Rasters can also be obtained via the [Get Online Maps](#) feature.

Creating Rasters

Rasters can be created from within GMS by interpolating from [2D scatter points](#). The [interpolation options](#), the raster cell size, and the extents of the raster can all be specified in the *Scatter* → *Raster* dialog.

Interpolating From Rasters

Rasters can be interpolated to most other objects, including the z values of [feature objects](#) and to [MODFLOW layers](#). The interpolation is done by finding the raster cells that the object's points are in and assigning to the points the values from the raster cells.

Multiple rasters can be interpolated to another object at once by simply selecting multiple rasters in the Project Explorer, right-clicking and selecting the appropriate interpolation command. This will result in the creation of multiple datasets on the object being

interpolated to. If the user desires to create only one dataset from all the rasters (because they are tiled next to each other, for example), the user can create a [raster catalog](#) and interpolate from it.

Conversion From Rasters

Rasters can be converted to the following:

- [2D grid](#)
- [2D scatter points](#)
- [UGrid](#)
- [Feature Contours](#)
- [Feature Contours at Given Elevation](#)
- [Resampled Raster](#)
- [Smoothed Raster](#)
- [Trimmed Raster](#)

Raster Display Options

The GIS tab of the [Display Options](#) dialog is used to change the way rasters are displayed. DEMs are imported and displayed as either 2D images or as a 3D point cloud.

Display as 2D image

If displaying as a 2D image, the raster is only visible in plan view (like other images). This option is fast and memory efficient and can support large rasters (or several rasters). Hill shading, which enables shadows and thus makes the image appear 3D, is available in this mode.

Display as 3D points

If displaying as 3D points, the raster is visible in any view, not just plan view. 3D points are

also very memory efficient but may be a little slower than the 2D image option. Also, hill shading is not available in this mode. The point size and the maximum number of points to display can be specified. Specifying a maximum number of points can be useful if the size of the raster is such that rendering becomes slow.

Shaders

With either 2D or 3D, four different shaders, which control the color ramp, are available. A color legend can be displayed to relate colors with values.

Raster Catalog

A raster catalog is an attribute table that references rasters that are currently loaded into the GMS project. Raster catalogs are used for interpolation and to create solids from horizons

Create a Raster Catalog

To create a raster catalog, simply select the desired rasters in the Project Explorer, right-click and select the **New Raster Catalog** command. A new "Raster Catalog" item will then appear in the Project Explorer.

The figure below shows a sample of the *Raster Catalog* dialog.

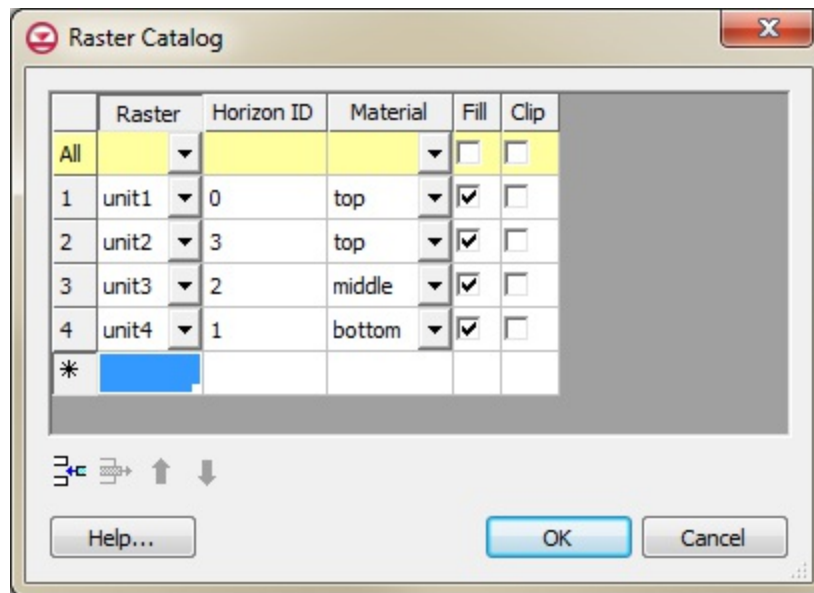

Example of the Raster Catalog dialog.

In the first column of the table selects the raster. Then enter a *Horizon ID* and the associated material. There are two additional fields: *Fill* and *Clip*. If the *Fill* field is turned on then the raster will be used in the interpolation process for the associated horizon. If the *Clip* field is turned on then any horizon surface with a horizon id less than the associated

horizon id will be clipped to this surface. The following images show examples of the effect of the *Clip* field.

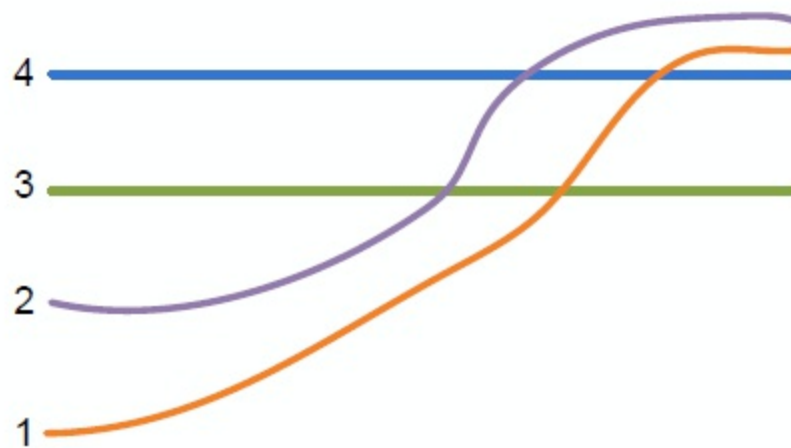

Raster surfaces.

The above figure shows a slice through raster surfaces that have been indexed with horizon ids. Below we see the resulting stratigraphy if the *Clip* field is off (zero) for each raster.

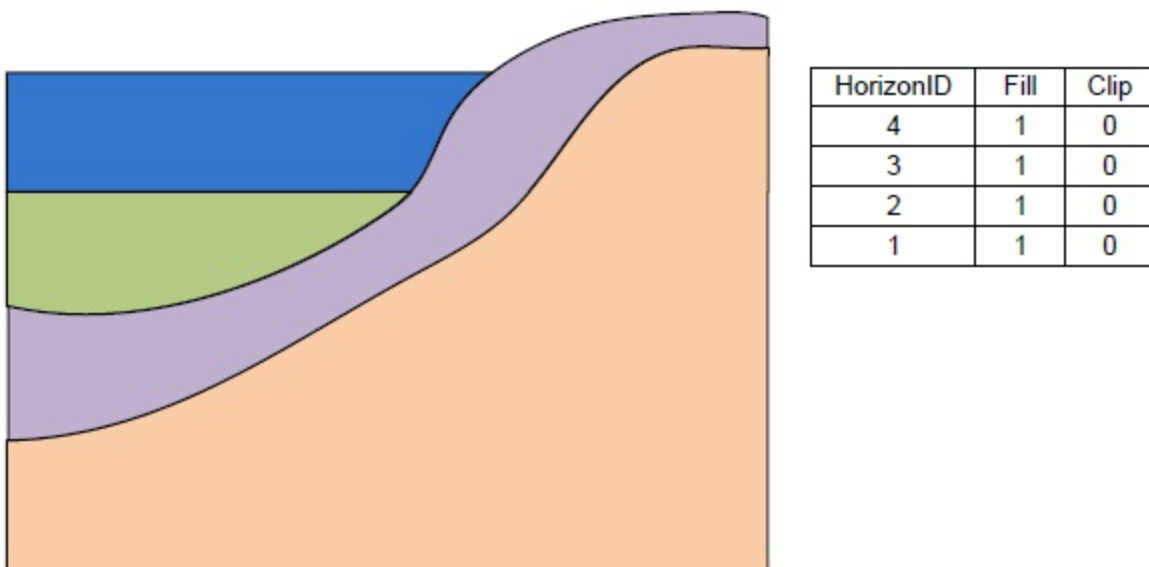

Stratigraphy with the Clip field turned off.

The next two examples show how the stratigraphy changes when the *Clip* field is turned on.

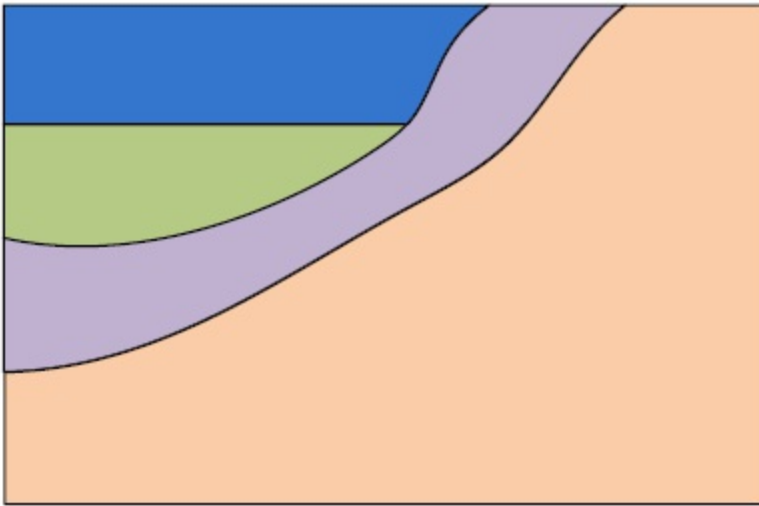

HorizonID	Fill	Clip
4	1	1
3	1	0
2	1	0
1	1	0

Stratigraphy with the Clip field on for horizon 4.

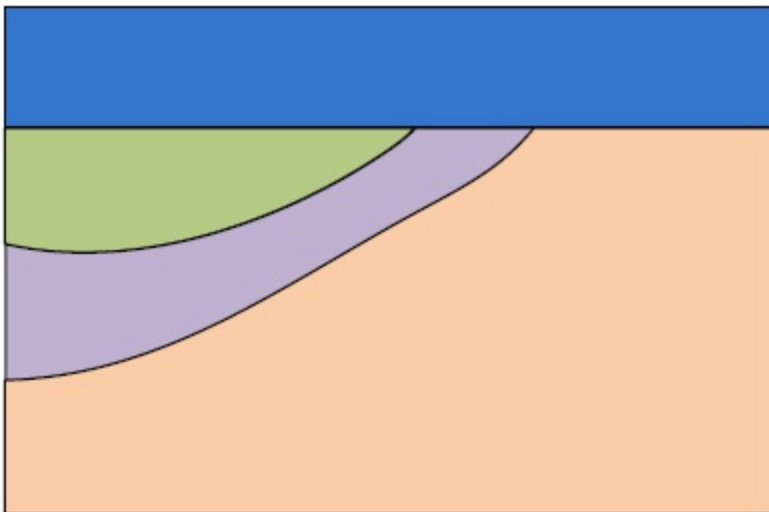

HorizonID	Fill	Clip
4	1	0
3	1	1
2	1	0
1	1	0

Stratigraphy with the Clip field on for horizon 3.

The final example shows a case where the *Fill* field is off and the *Clip* field is on.

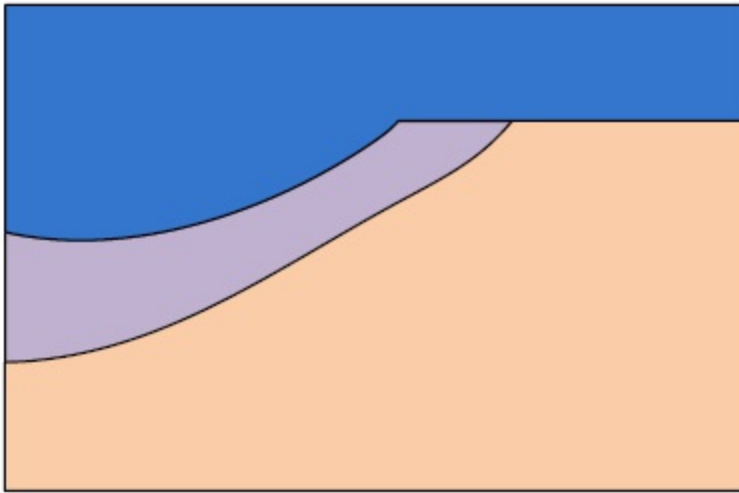

HorizonID	Fill	Clip
4	1	0
3	0	1
2	1	0
1	1	0

Stratigraphy with the Fill-off and Clip-on for horizon 3.

Horizons → Solids

Raster catalogs are used to create solids using the [horizons to solids](#) method. Each raster represents the top of a horizon. Right-click on the raster catalog in the Project Explorer and select the **Horizons → Solids** command to start the [Horizons to Solids](#) wizard.

Interpolation

A raster catalog can be interpolated to other GMS objects (TINs, meshes etc) by right-clicking on the raster catalog and selecting the desired [interpolation command](#). Unlike interpolating from multiple selected rasters, when interpolating from a raster catalog, only one dataset will be created.

Enabling ArcObjects

ArcObjects® is a development platform provided by ESRI that allows developers of other applications (such as GMS) to incorporate ArcView/ArcGIS® capability directly within their application. GMS can use ArcObjects® to access some of the same functionality in GMS that is available in ArcGIS®, providing GMS is running on a computer that has a current license of ArcGIS®.

The *Data* | **Enable ArcObjects** command queries the ESRI license manager for ArcView/ArcGIS® to see if a license exists. If a valid license is found then the ArcGIS functionality within GMS is enabled. If a license is not found then the ArcGIS specific features remain unavailable.

ArcObjects® is a development platform provided by [ESRI®](#) that allows developers of other applications to incorporate ArcView/ArcGIS® capability directly within their application. ArcObjects® is used to incorporate ArcGIS® functionalities into XMS software. This allows users to use ArcGIS® functionality within XMS software. In order to use ArcGIS® functionality, a current license of ArcGIS® must be installed. Without a license, much of the same functionality is available, the primary differences being that only the shapefile format is supported, and many of the selection and display capabilities are minimal.

"Error initializing EMRL_LicCheckMod.dll"

If the dll "EMRL_LicCheckMod.dll" fails to register automatically, selecting the **Enable ArcObjects** command will bring up the error "Error initializing EMRL_LicCheckMod.dll". Please contact Technical Support". To fix this, register the dll manually by following the steps below.

1. Select "Start | Run"
2. Type in 'regsvr32 "<directory where GMS 7.0 was installed>\EMRL_LicCheckMod.dll"

The default location for GMS 7.0 is "C:\Program Files\GMS 7.0". If

the program was installed in the default location, for

example, this line in the Run window will be: `regsvr32 "C:\Program Files\GMS 7.0\EMRL_LicCheckMod.dll"`

3. Select **OK**

4. Restart GMS 7.0

Related Topics

- [ArcObjects](#)

GIS Conversion and Editing

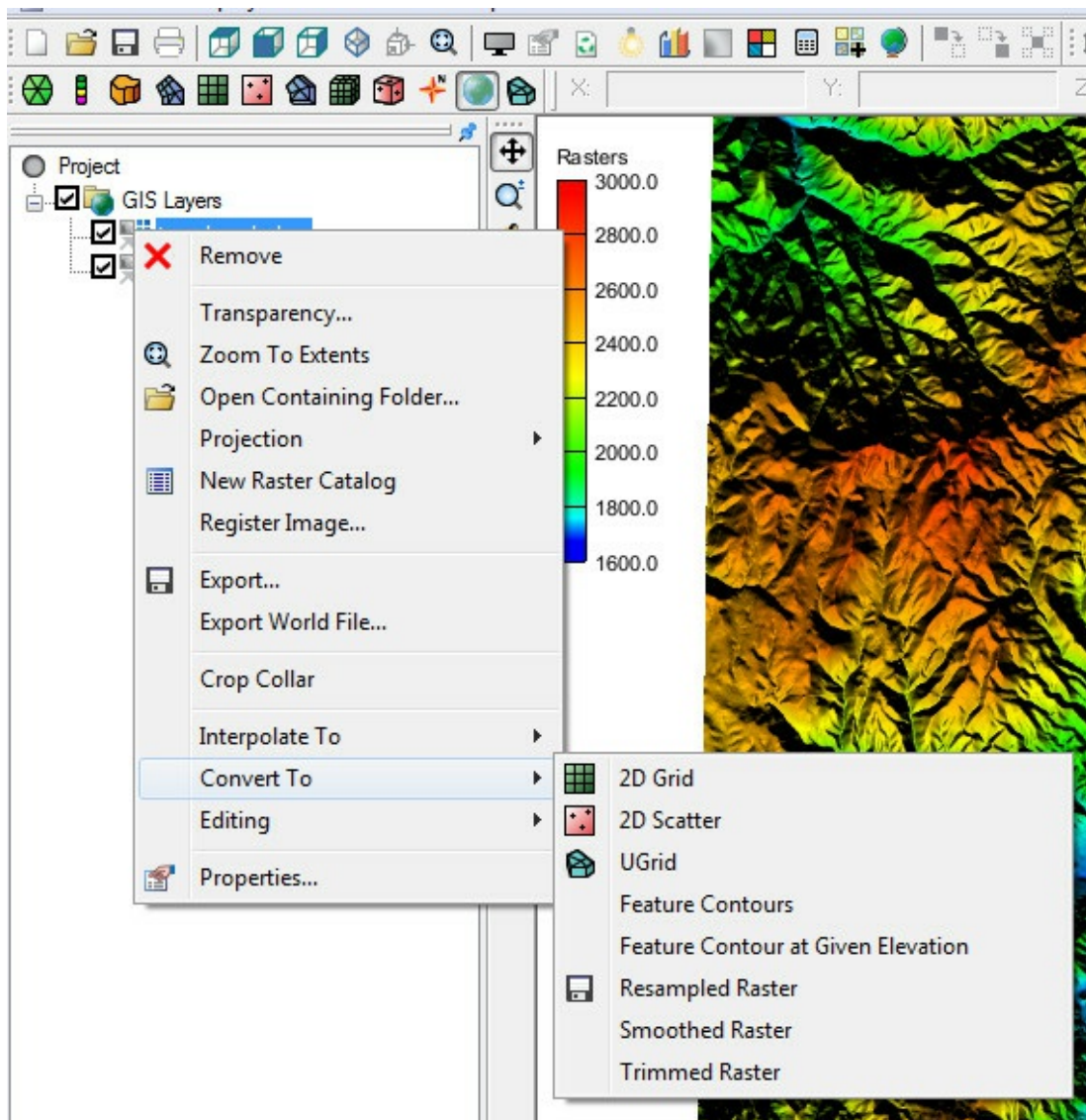

Example of a GIS item right-click menu in GMS.

GMS, SMS, and WMS can load GIS data such as digital elevation models (DEMs) and images. This GIS data will appear in the GIS Data section of the Project Explorer.

GIS Data Conversion

Both GMS and SMS offer methods to convert GIS data. Right-clicking on a GIS data item in the Project Explorer brings up a menu with a *Convert To* sub-menu. The commands in the

Convert To sub-menu are:

Raster to 2D Scatter

Selecting the command *Convert To* | **2D Scatter** will bring up the *Raster* → *Scatter* dialog. The dialog shows the number of scatter point that will be generated in the new set and allows naming the new scatter set. By default, the name of new scatter set will be the same as the raster set unless changed.

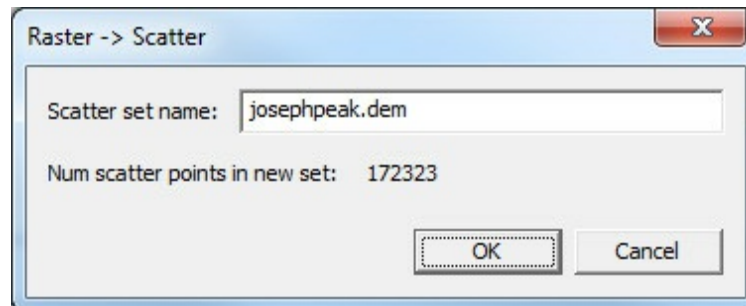

Example of the Raster → *Scatter* dialog.

By default scatter points are shown in red unless changed in the *Display Options* dialog. It may necessary to zoom in to see each point. Scatter points are visible in other views while the DEM is visible only in plan view.

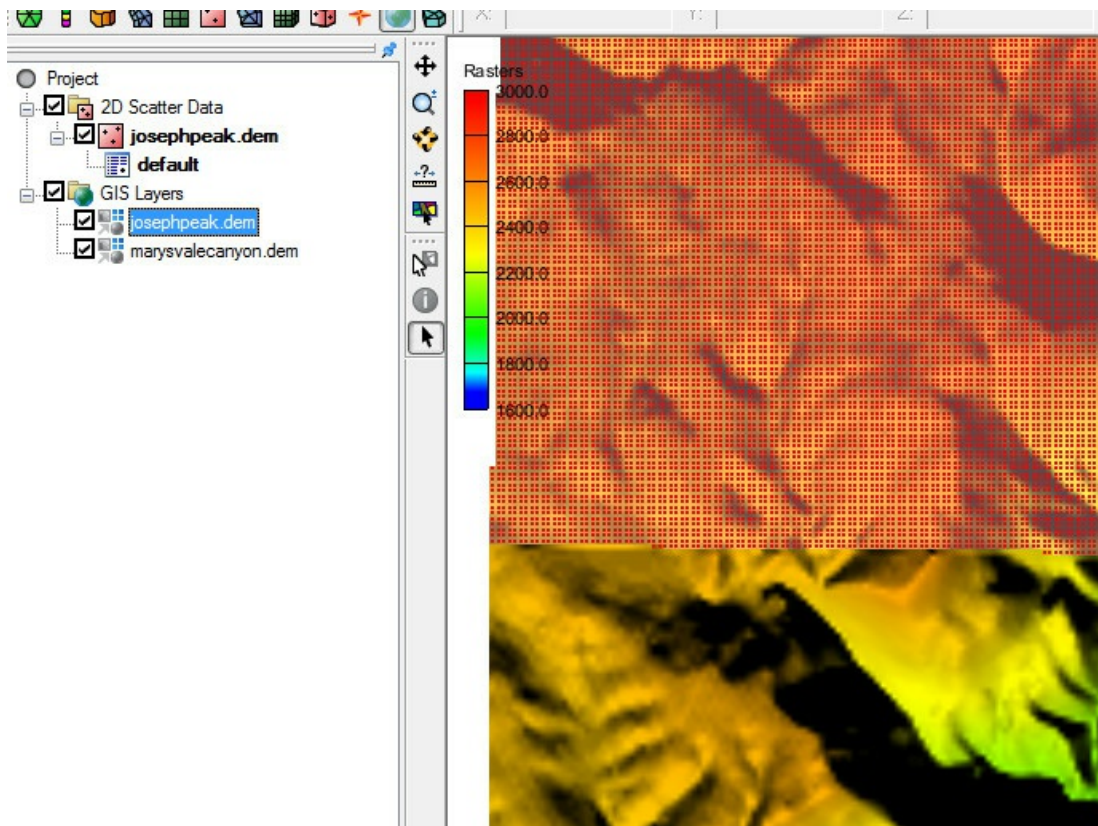

Example of a scatter set generated from a raster set.

Feature Contours

Activating this command will automatically generate contours which will appear as a new coverage under Map Data in the Project Explorer. By default, contour lines are shown in black unless the contour color is changed in the *Display Options* dialog. The contour interval is found by creating ten contours evenly spaced between the min and max dataset values.

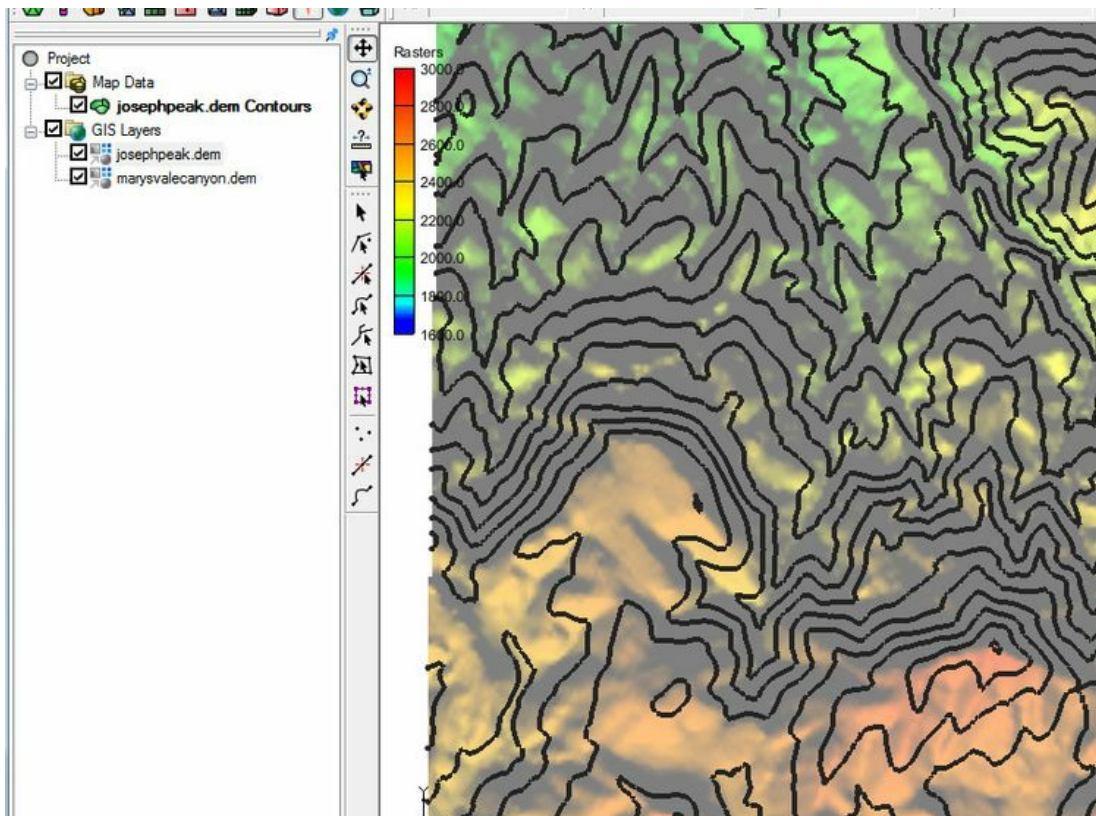

Generated feature contours appearing as black lines.

Feature Contours at Given Elevation

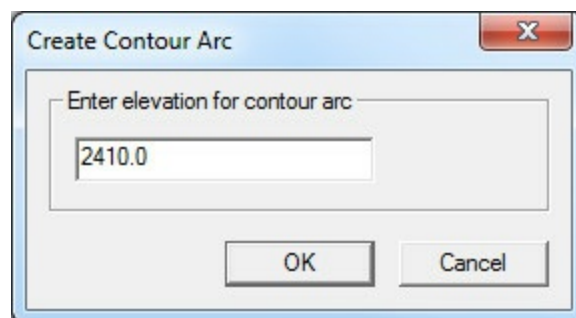

Example of the Create Contour Arc dialog.

This command will bring up the *Create Contour Arc* dialog. In this dialog, specify an elevation to be used in generating the contours.

After entering an elevation and clicking **OK**, contours will be generated similar to those created with the **Feature Contours** command but using the specified elevation. Only contours at the specified elevation will be generated.

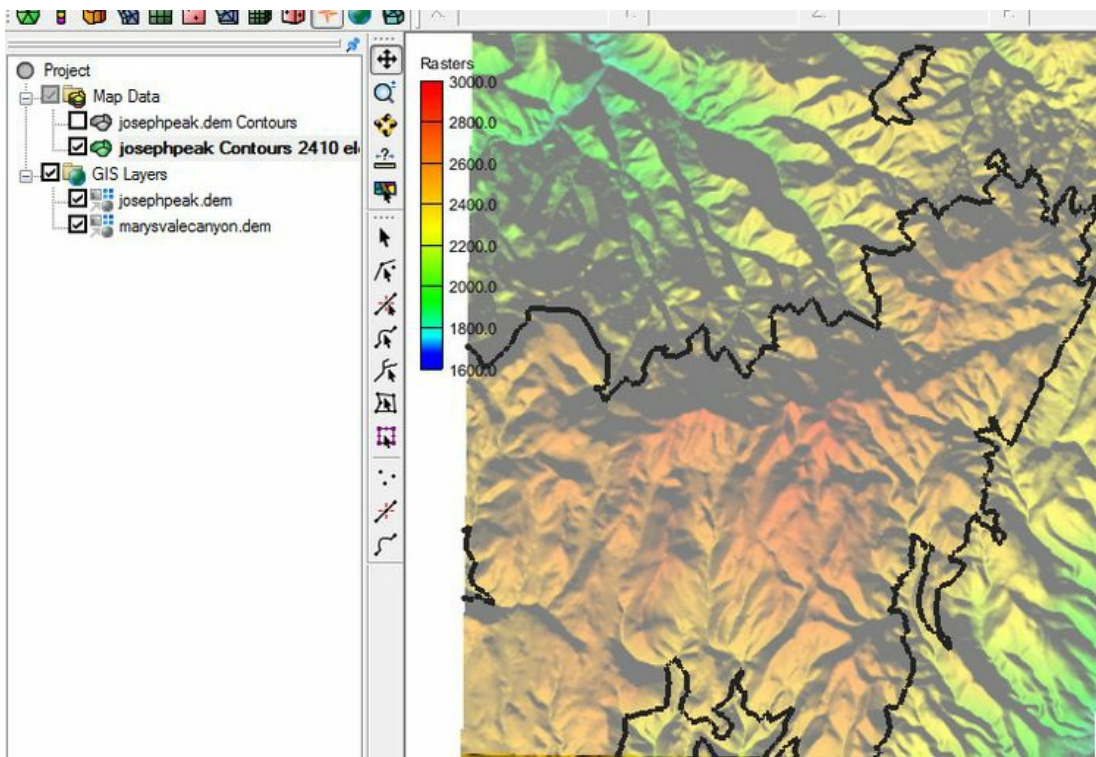

Example of feature contours generated using a given elevation.

GIS Data Editing

Resampled Raster

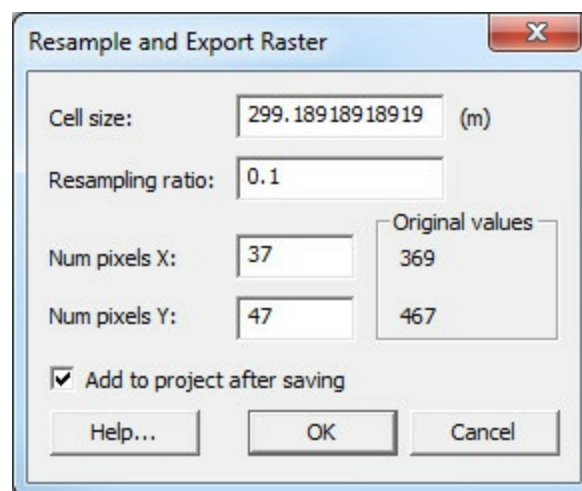

Resample and Export Raster dialog.

This command will bring up the *Resample and Export Raster* dialog. Resampling creates a

new DEM covering the bounds of the selected DEM with a specified spacing. The dialog has the following options:

- *Cell size* – Specify the size of each cell based on the *Resampling ratio*.
- *Resampling ratio* – Specifies the resampling ratio. This is required for processing. Changing this field will change the other fields in the dialog automatically.
- *Num pixels X* – The number of pixels on the x axis that will be generated. The original number will be displayed to the right.
- *Num pixels Y* – The number of pixels on the y axis. The original number will be displayed to the right.
- *Add to project after saving* – Toggling this option on will load the resampled file into GMS/SMS upon completion.

After completing the *Resample and Export Raster* dialog, and clicking **OK**, the *Save As* dialog will appear to save a file with the resampled data.

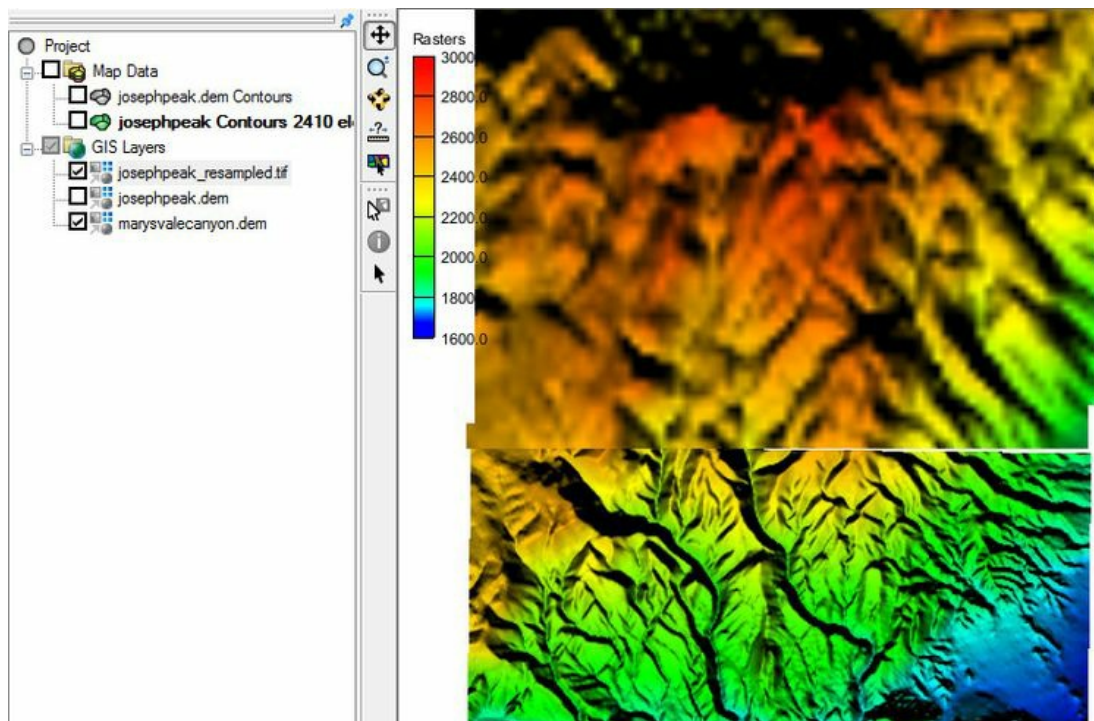

Example of resampled raster data.

Smoothed Raster

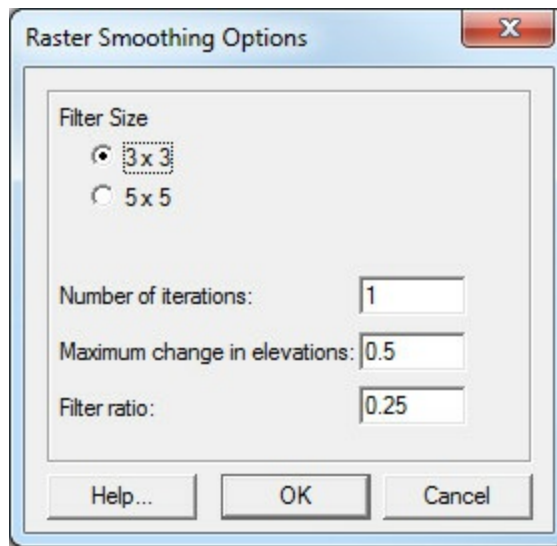

Raster Smoothing Options dialog.

This command will bring up the *Raster Smoothing Options* dialog. The dialog is used to smooth the values on the DEM based on use specified weighting functions. The dialog has the following options:

- *Filter Size* – To smooth the raster, an N x N filter matrix is placed over each elevation point and a new elevation is computed by taking an inverse-distance weighted average of all elevations within the filter. The dimension of N can be specified as either 3x3 or 5x5, meaning that new elevations are computed from either the nearest 8 or 24 neighboring points.
- *Number of iterations* – Specify the number of smoothing iterations. By default only one iteration is done, but sometimes several smoothing iterations are required to propagate a change in elevations across a large flat area.
- *Maximum change in elevation* – Can be used to ensure that the integrity of the original elevations are maintained.
- *Filter ratio* – Should be between 0-1, and is used to specify the weight of the central cell of the filtering matrix.

After completing the *Raster Smoothing Options* dialog, and clicking **OK**, the *Save As* dialog will appear to save a file with the smoothed data.

Trimmed Raster

This command creates a new DEM from the selected DEM trimmed to the bounds of the active coverage or the selected polygons of the active coverage. Coverage polygons must be selected to define the trimming rectangle. If this is not done, then a warning dialog will appear as a reminder.

To create a trimmed raster:

1. Select a coverage (or create a new coverage) in the Map module.
2. Select the **Create Feature Arc** tool and draw a closed set of arcs.

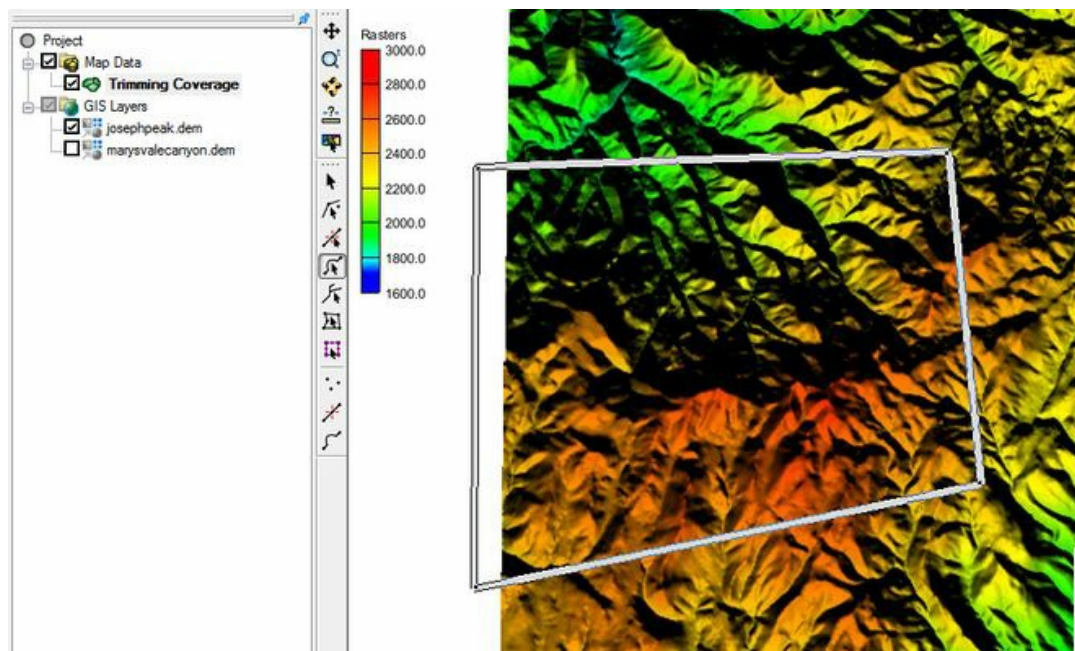

Closed set of arcs drawn over a raster.

3. While the arcs are selected, go to *Feature Objects* | **Build Polygons**.
4. Use the **Select Polygon** tool to select the polygon just created.

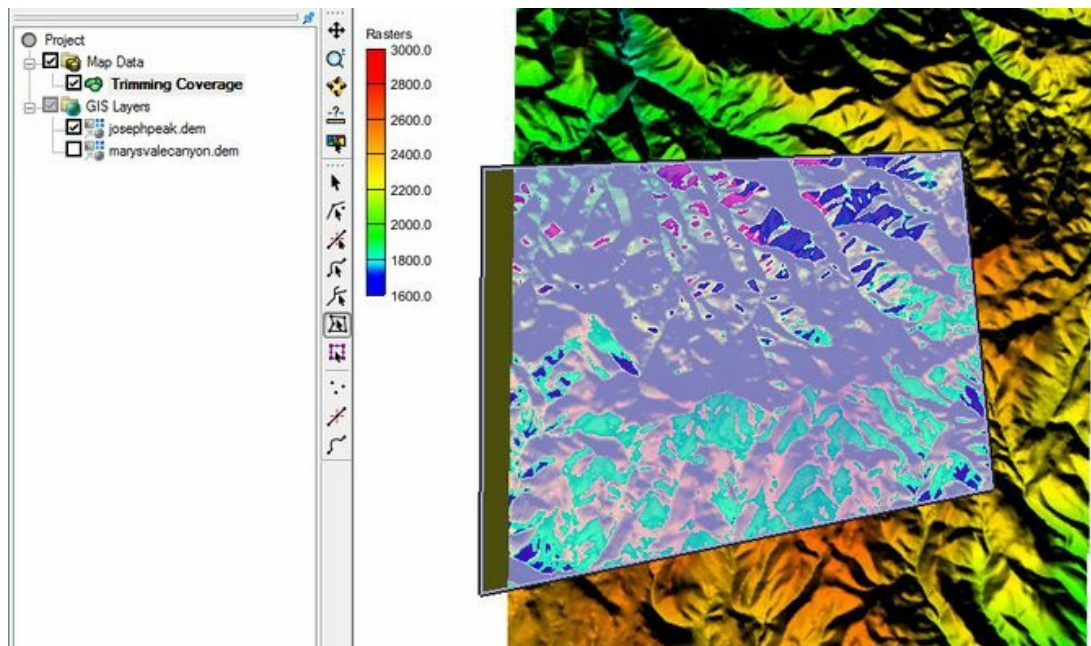

*Selected polygon just prior to using the **Trimmed Raster** command.*

5. Right-click a DEM in the GIS data and select **Convert To | Trimmed Raster**.
6. The **Save As** dialog will appear to save a file with the trimmed data.

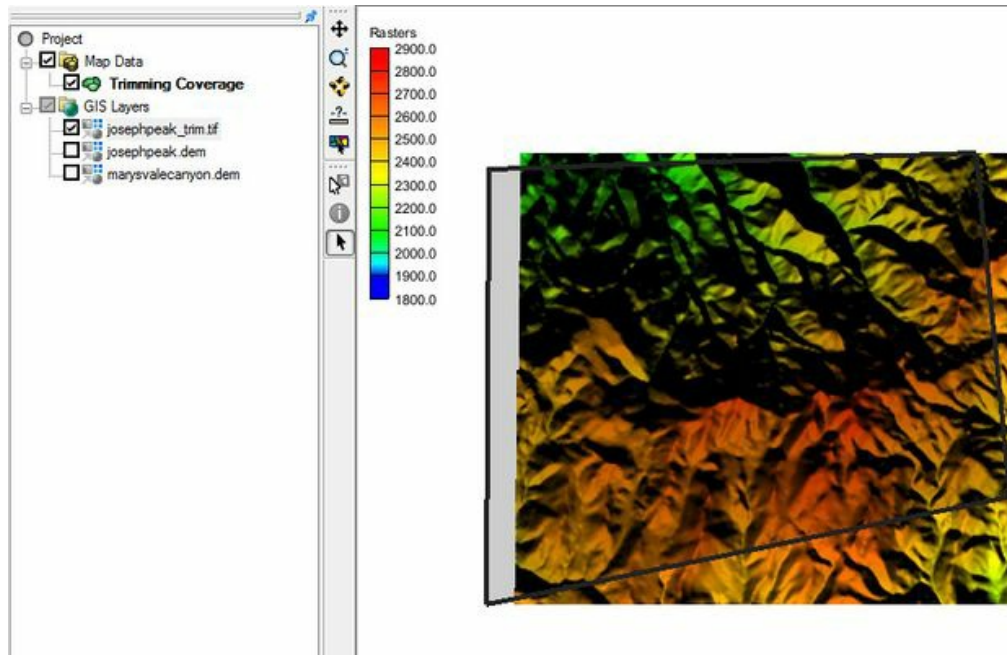

Example of a trimmed raster.

The final raster is trimmed along the rectangle enclosing the polygon. Trimmed rasters will also trim to the rectangle enclosing multiple selected polygons.

Merged Raster

This command appears when multiple rasters are selected. It creates a new raster that covers all selected rasters with a resolution set to the smallest cell size of any of the selected rasters. Two or more DEM datasets can be merged together by doing the following:

1. Select two or more DEM items in the project explorer by holding down the *Shift* key while selecting each item.
2. Right-click on one of the selected DEMs and select *Convert To | Merged Raster*. This command is only available when multiple raster items have been selected.
3. The *Save As* dialog will appear to save a file with the merged data.

The new merged DEM will be visible in the Project Explorer. When merging, the smallest cell size among the merging rasters is used.

Edit Raster

A DEM may have bad cell values or based on the resolution may not represent continuous values along a line. These value can be edited to remove the bad value or ensure continuous representation of a feature such as an embankment or channel. The new values are specified using feature objects (arcs or nodes) in the Map module. To create an edited raster:

1. Select (or create) one or more feature arcs/feature nodes with the desired raster values specified on the feature object. (i.e. the z-value specified for the nodes/vertices/points represent the values desired under the feature objects in the raster)
2. Right-click on one of the selected DEMs and select *Editing | Arc Elevation Profile*.
3. The *Save As* dialog will appear to save a file with the edited data.

The new edited DEM will be visible in the Project Explorer.

Saving Raster Data

Raster data being converted can be saved in any of the following formats:

- GeoTiff Files (*.tif)
- BIL Files (*.bil)
- Erdas Imagine IMG Files (*.img)
- Surfer ASCII Grid Files (*.grd)
- Surfer Binary grid v6 Files (*.grd)
- Surfer Binary Grid v7 Files (*.grd)
- USGS ASCII DEM Files (*.dem)
- XYZ ASCII Grid Files (*.xyz)
- Arc Info ASCII Grid Files (*.asc)
- DXF 3D Point Files (*.dxf)
- Float/Grid Files (*.flt)
- DTED Files (*.dtf)
- Vertical Mapper (MapInfo) Grid Files (*.grd)
- Global Mapper Grid Files (*.gmp)
- Windsim GWS Files (*.gws)

Related Topics

- [Raster Options](#)
- [Get Online Maps](#)
- [GIS Module](#)
- [WMS:Smoothing DEMs](#)
- [SMS GIS Module](#)

GIS to Feature Objects

GIS vector data can be converted to [Feature Objects](#) (points, arcs, polygons in coverages) for use in a [conceptual model](#). Attributes associated with the GIS data can also be mapped over to attributes associated with Feature Objects. Two commands are available for converting GIS vector data to Feature Objects: *GIS | ArcObjects* → **Feature Objects** (with an ArcObjects license) and *GIS | Shapes* → **Feature Objects**. Selecting either of these commands will bring up *GIS to Feature Objects* wizard.

Before starting the wizard, make sure to set the appropriate coverage as the active coverage since the wizard will convert the GIS data to new Feature Objects in the active coverage. Also, if mapping over attributes, make sure the GIS coverage attributes are defined before doing the conversion.

If the user only wishes to convert a portion of the GIS vector data to Feature Objects then select the desired GIS data before beginning the wizard. If the user wishes to map all the features, begin the wizard and it will ask if the user wants to convert all features since none are selected.

Follow the instructions in the mapping wizard to convert the GIS data to Feature Objects.

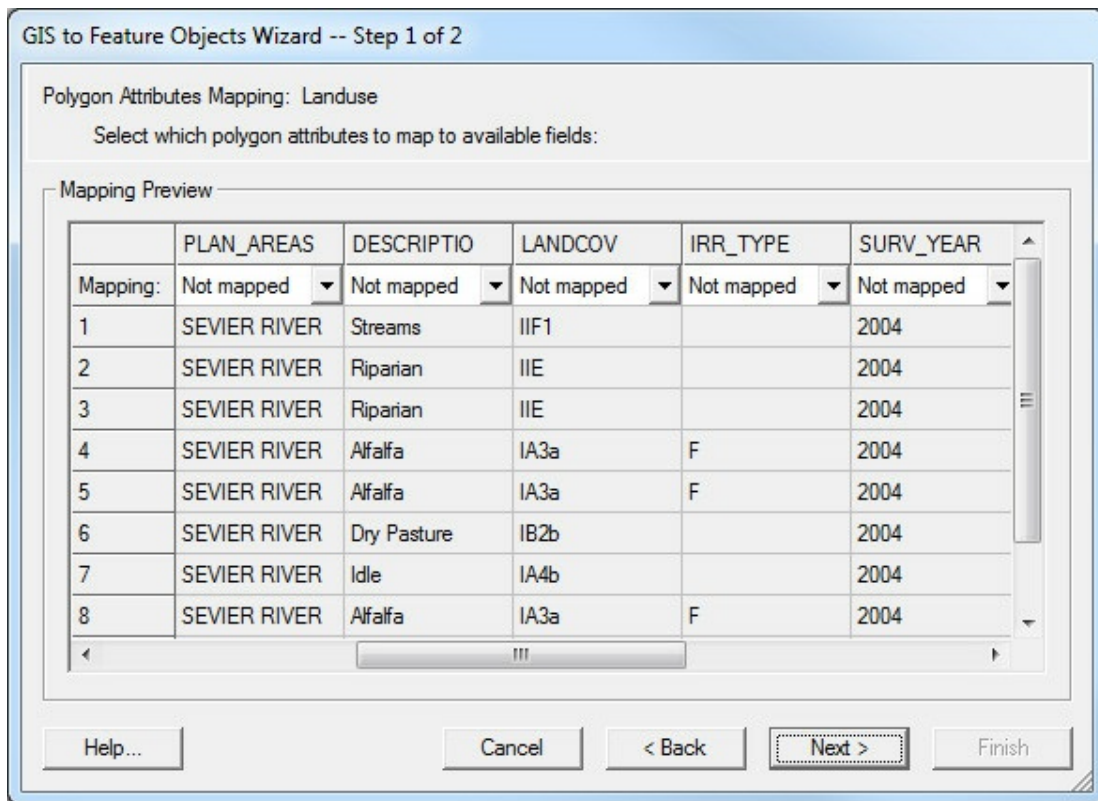

GIS to Feature Objects Wizard dialog showing the first step in the conversion process.

Add Data

GMS provides two options for adding GIS data: **Add Shapefile Data** and **Add Data**. The first option can be used without a license of ArcView®. The second option is only available with an ArcView® License.

GIS data cannot be imported using the **Open** command unlike most other data types in GMS.

Add Shapefile Data

The *Data* | **Add Shapefile Data** command allows opening shapefiles as GIS layers in GMS. The command brings up the *Select Shapefile* dialog which functions the same as the *Open* dialog. Without a license of ArcView on the computer then shapefiles are the only supported format for GIS layers. With a valid license of ArcView the *Data* | **Add Data** command is available and any of the ESRI supported formats can be opened as GIS data layers.

Add Data

The *Data* | **Add Data** command is available when [ArcObjects®](#) is enabled and uses the same dialog resource to open GIS data layers that is used by ArcView®.

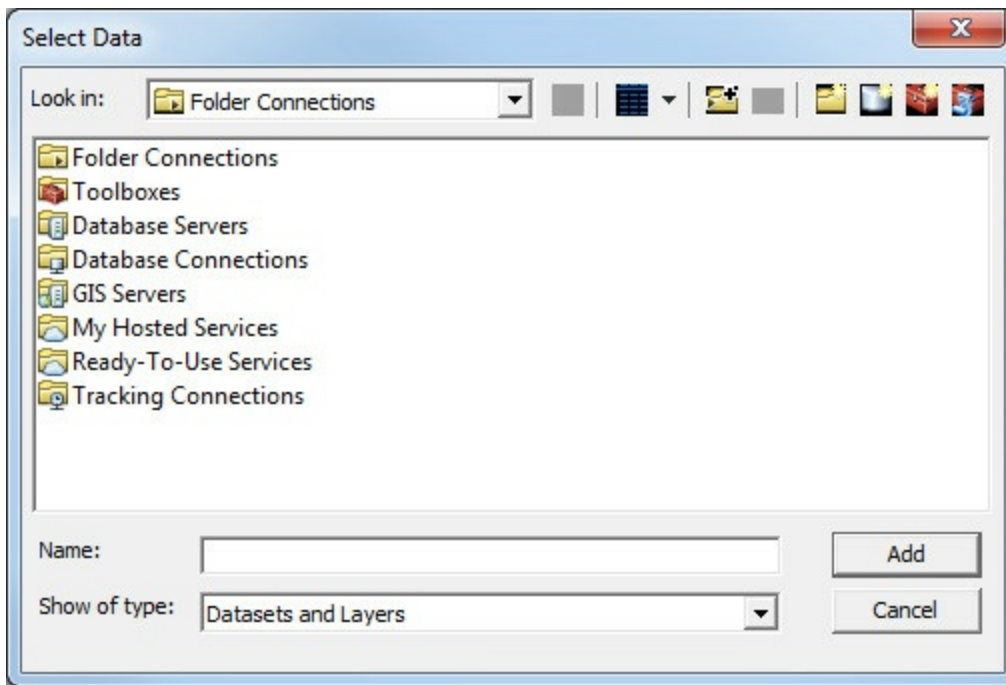

Select Data dialog

When ArcObjects® is enabled, GMS is able to load any of the ESRI supported formats, including shapefiles, coverages, geodatabases, grids, images, CAD files and others, as GIS data layers. These data can then be converted to GMS feature objects in map coverages. See ArcGIS documentation for details on how to use this dialog.

Arc Hydro Groundwater

[Arc Hydro Groundwater](#) is a data model and a suite of tools for groundwater data that is integrated with [ESRI's ArcGIS](#). GMS can import and export data in a geodatabase consistent with the Arc Hydro Groundwater standard.

Export to Arc Hydro Groundwater

To export data from GMS into an Arc Hydro Groundwater geodatabase, select the *File | Save As* menu command and change the file type to Arc Hydro Groundwater Geodatabase. In order for the export to be successful the following things must be true:

- ArcObjects must be enabled.
- The data must be in a non-local [projection](#).

Import from Arc Hydro Groundwater

An Arc Hydro Groundwater geodatabase may be imported into GMS. This is done by [enabling ArcObjects](#) and, in the [GIS module](#), selecting the *GIS | Add Data* menu command. Selecting the Arc Hydro Groundwater geodatabase from the *Add Data* dialog will display the items the geodatabase contains. The user may then select which items to import into GMS.

GIS Commands

The *GIS* menu appears when GIS data has been loaded into GMS. The menu has a submenu, the *Selection* submenu, which contains its own submenu, the *Interactive Selection Method* submenu. The following commands are available in the *GIS* menu:

Enable ArcObjects

Loads ArcMap [ArcObjects](#) so that ArcMap can run inside of GMS. This command is only available in 32 bit GMS since ArcMap is a 32 bit application. An ArcGIS must be installed with a valid license (or have access to a network license).

Add Data...

Calls ArcObjects and uses ESRI's [Select Data](#) dialog.

Delete Layer(s)...

Brings up a dialog where it is possible to select from the currently loaded layers and remove them from the GIS data. ***ArcObjects only.***

A more efficient way to remove layers from a project would be to select the item in the and select delete.

ArcObjects → Feature Objects

Converts ArcObjects vector data to feature objects using the [GIS to Feature Objects](#) wizard.

Shapes → Feature Objects

Converts Shapefile data to feature objects using the [GIS to Feature Objects](#) wizard.

Selection >

Select By Attributes...

Brings up ESRI's *Query Wizard* for selecting based on attribute. ***ArcObjects only.***

Select By Location...

Brings up ESRI's *Select By Location* dialog. ***ArcObjects only.***

Clear Selected Features

Clears all selections of GIS data. ***ArcObjects only.***

Interactive Selection Method >

Allows selecting how ArcObjects will process new selections based on the 4 options listed below. ***ArcObjects only.***

Create New Selection

Mode for handling interactive selection. ***ArcObjects only.***

Add to Current Selection

Mode for handling interactive selection. ***ArcObjects only.***

Remove from Current Selection

Mode for handling interactive selection. ***ArcObjects only.***

Select from Current Selection

Mode for handling interactive selection. ***ArcObjects only.***

Options...

Brings up ESRI's *Selection Options* dialog. ***ArcObjects only.***

Selectable Layers...

Allows choosing which GIS layers can have selections. ***ArcObjects only.***

Visible Layers...

Allows choosing which GIS layers are visible. ***ArcObjects only.***

A more efficient way to change the visibility of the GIS layer is to use the check box next to the item in the Project Explorer

Map Properties...

Brings up the *Properties* dialog for the ESRI map and shows the current coordinate system.

GIS Right-Click Menu

The following commands are available by right-clicking on GIS objects in the Project Explorer.

Attribute Table...

Brings up *Attribute Table* of the selected GIS layer.

Join Table to Layer...

Brings up *File Browser* dialog to choose a dbf file to join to a GIS layer.

Transparency...

Allows setting the transparency on raster layers or, if using ArcObjects, any GIS layer.

Properties...

Brings up the *Properties* dialog for the selected layer.

Convert To >

Feature Objects

Converts Shapefile data to feature objects using the [GIS to Feature Objects](#) wizard.

2D Scatter Points

Converts GIS point layers to 2D scatter points.

UGrid

Converts GIS polygon data to an unstructured grid.

Trimmed Raster

Creates a new DEM from the selected DEM trimmed to the bounds of the active coverage or the selected polygons of the active coverage.

Add Shapefile Data...

Adds a shape file to the GIS data.

Clear All Data

Removes all GIS data from the project.

Related Topics

- [GIS Module](#)

5.12. UGrid Module

UGrid Module

The UGrid module is used with unstructured grid (UGrid) geometric objects. Unstructured grids are very flexible. They can include many types of cells including 2D and 3D cells and cells with any number of faces and nodes. This type of geometric object is used with [MODFLOW-USG](#) which uses a finite volume approach.

Eventually UGrids will be used for all the things that [2D grids](#) and [3D grids](#) are currently used for. A UGrid is similar to the old 3D grids and meshes available in GMS but much more flexible. UGrids can use any type of cell, meaning cells with any number of faces and nodes. This flexibility allows for more realistic modeling of geologic features such as pinchouts.

Interfaces to the following 3D finite difference models are provided in this module:

- [MODFLOW-USG](#)

The UGrid module support the following types of unstructured grids:

- *Regular (not refined)* – A grid with rectangular cells that are not refined.
- *Quadtree* – A grid with rectangular cells that are refined in a quadtree manner around any points, arcs and polygons which specify the refinement attribute and refinement size. The cells surrounding the points, arcs, and polygons are also refined to smooth change from coarse cells to refined cells.
- *Nested* – A grid with rectangular cells that are refined like the quadtree option, but the surrounding cells are not smoothed.
- *Voronoi* – A grid with cells of various sizes and shapes which meet the Voronoi criteria. The mesh is refined around points that are marked as refine points based on the specified refinement size. The mesh is constructed to honor all arc geometry. If refinement is specified as an attribute on arcs or polygons it is ignored.

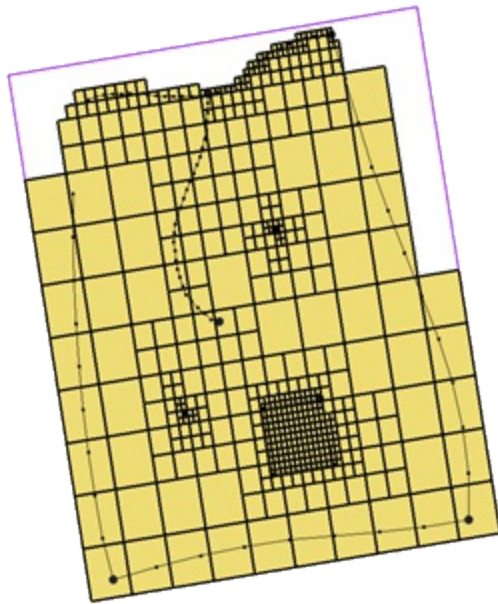

UGrid quadtree example

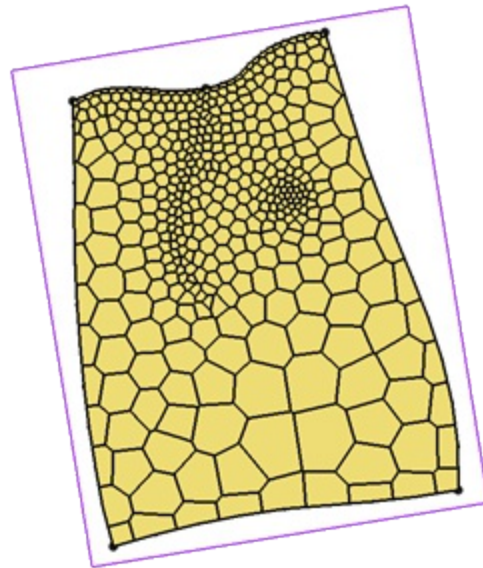

UGrid Voronoi example

Creating and Editing UGrids

There are a number of ways to create UGrids. Currently UGrids cannot be edited after they are created.

Importing

UGrids can be imported from a [VTK XML file](#) by selecting the *File* | **Open** command or by dragging and dropping the file onto the GMS window. GMS recognizes the ".vtu" extension, which by convention is the extension used for a VTK XML file containing an unstructured grid.

New 2D or 3D UGrid

Right-clicking anywhere in the Project Explorer or on the UGrid data item will display a menu with **New UGrid 2D** and **New UGrid 3D** commands. These commands bring up the *New UGrid* dialog which specifies options for the creation of a new UGrid, and is very similar to the [Create Grid](#) dialog for 3D structured grids.

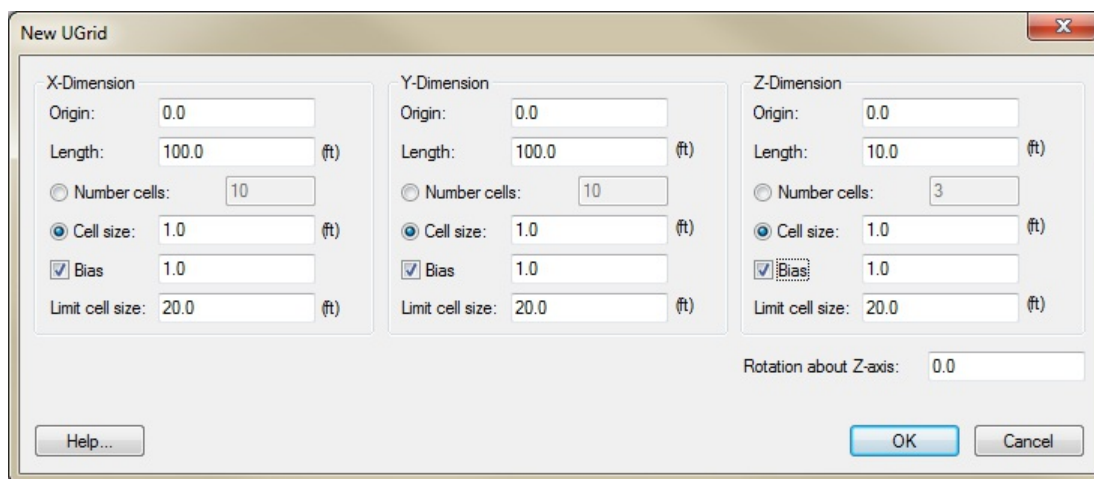

The New UGrid dialog

Map → UGrid

The **Map → UGrid** command creates a UGrid from feature objects. It can be found in the *Feature Objects* menu, in the Map toolbar, and in some pop-up menus when right-clicking on items in the [Project Explorer](#) (Coverage, Grid Frame). The command opens the *Create UGrid* dialog.

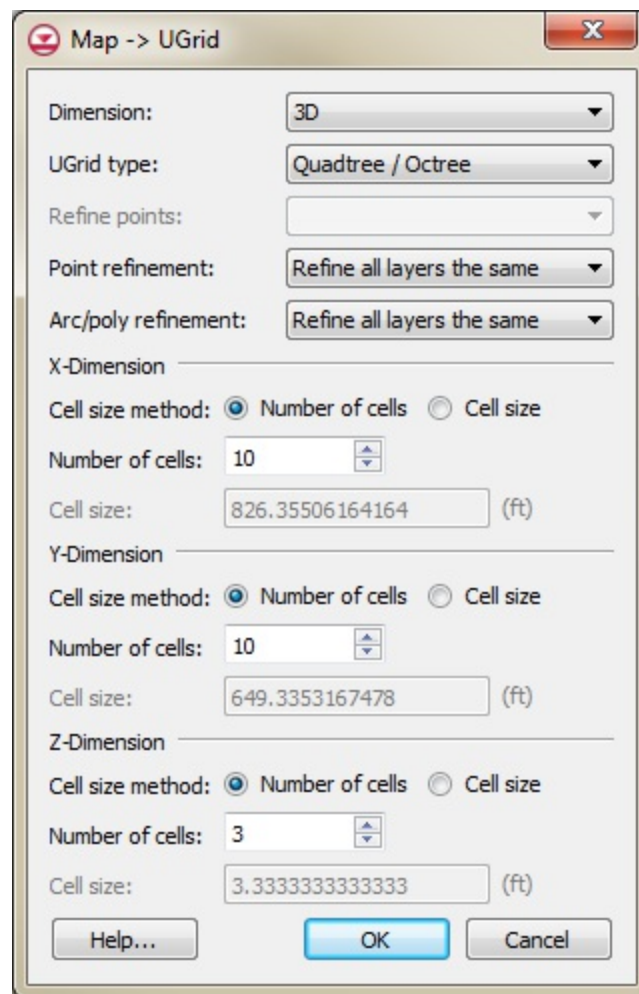

Map → UGrid dialog.

Map → UGrid Dialog

- *Dimension* – Specifies whether a 2D or 3D UGrid will be created.
- *UGrid type*
 - *Regular (not refined)* – Creates a grid with rectangular cells that are not refined. Any refinement attributes specified on feature objects are ignored.

- *Quadtree* – Creates a grid with rectangular cells that are refined in a quad tree manner around any points, arcs and polygons which specify the refinement attribute and refinement size. The cells surrounding the points, arcs, and polygons are also refined to smooth change from coarse cells to refined cells.
 - *Nested* – Creates a grid with rectangular cells that are refined like the quadtree option, but the surrounding cells are not smoothed.
 - *Voronoi* – Creates a Voronoi grid with cells of various sizes and shapes which meet the Voronoi criteria. Only the active coverage is used and it must contain a polygon because the algorithm uses the polygon to create a triangular mesh. The mesh is refined around points that are marked as refine points based on the specified refinement size. The mesh is constructed to honor all arc geometry. If refinement is specified as an attribute on arcs or polygons it is ignored.
- *Refine points* – If the *Quadtree / Octree* option is selected and refine points exist in multiple coverages (available when "Refinement" is selected in the [Coverage Setup](#) dialog), specifies which refine points to use.
 - *Point refinement* – If the *UGrid type* is *Quadtree / Octree*, this combo box shows the option *Refine all layers the same* which will result in all layers having the same number of cells, and the *Octree* option which refines and smooths in the vertical direction.
 - *Arc/poly refinement* – Similar to the *Point refinement* option for arcs and polygons and with the addition of the option *Quadtree on assigned layers* which refines horizontally in a quadtree fashion for only the layers that the arcs and polygons are assigned to in the attribute tables.
 - *X, Y, Z number of cells*
 - If not using the Voronoi UGrid type, the size and number of cells in the X, Y and Z dimensions can be specified. For quad tree UGrids, the cell size represents the large, unrefined size. The small, refined size is determined by the refinement specified at points, arcs and polygons. Also for quad tree UGrids, if the cell size is specified, it represents a target cell size (large, unrefined size); the actual cell size will likely be somewhat different so that the cells fit within the grid boundaries.

If a [grid frame](#) exists, it is used to determine the location of the grid boundaries. If polygons exist and the *Regular* or *Quad tree* options are used, any cells that are not inside a polygon are not included in the UGrid.

Below are various UGrids created from the same coverage:

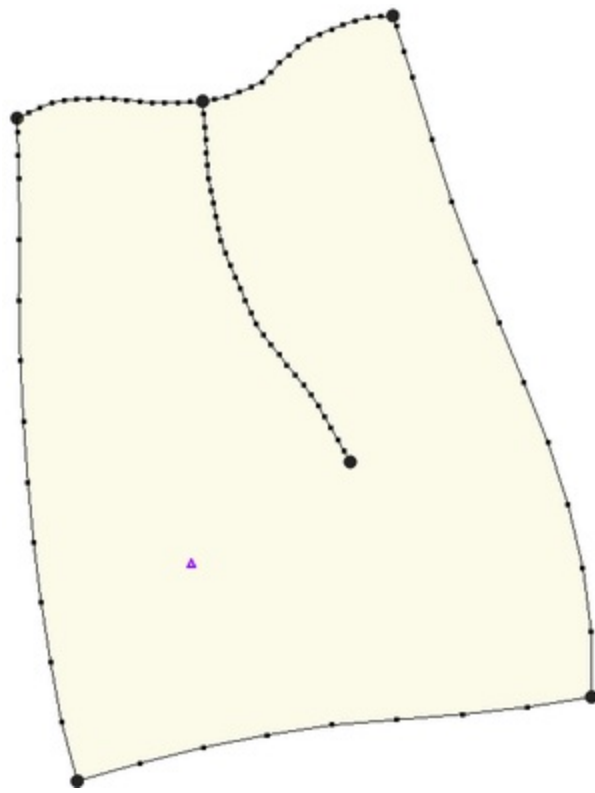

Coverage

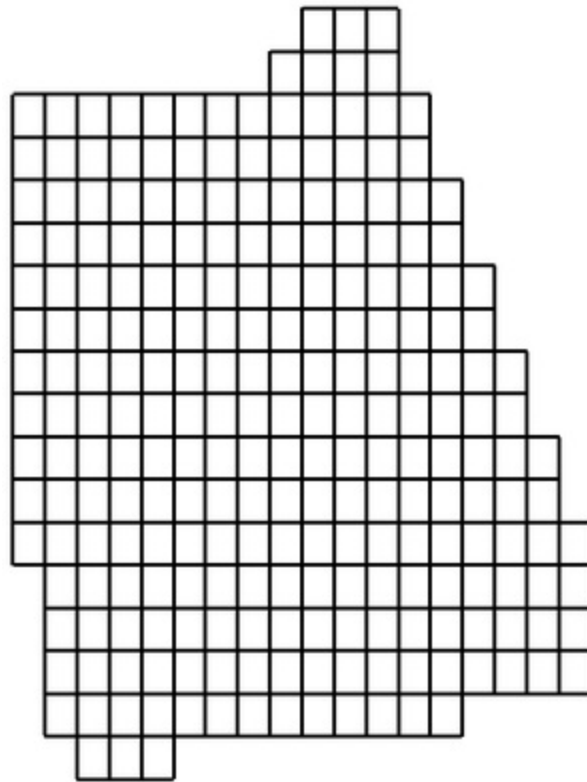

Regular UGrid

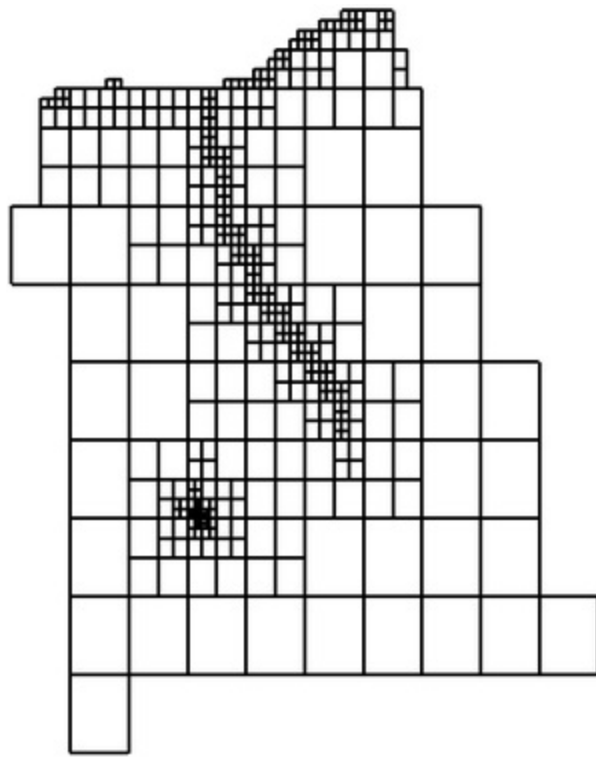

Quadtree UGrid

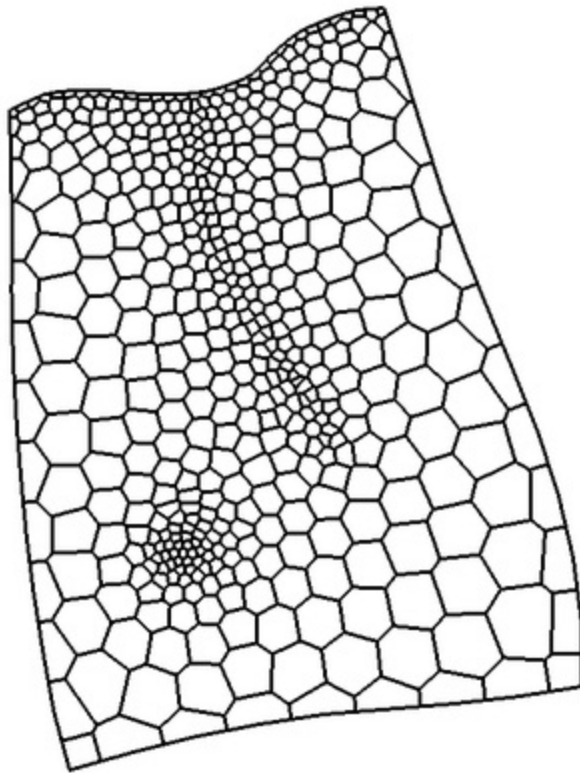

Voronoi UGrid

Conversion From Other Data Types

The following data types can be converted to UGrids by right-clicking on the object in the [Project Explorer](#) and selecting the **Convert To** → **UGrid** command from the pop-up menu.

- [TINs](#)
- [2D Grids](#)
- [3D Grids](#)
- [2D Mesh](#)
- [3D Mesh](#)
- [Polygons](#) in a [coverage](#)(*Map To* → *Polygons* → *UGrid*)
- Polygon shape files in the [GIS Module](#)

Horizons

The [Horizons](#) → [UGrid](#) command (in the [TINs](#) and [Boreholes](#) menus) uses [horizons](#) to create a 3D UGrid.

Extrude Down to 3D UGrid

Right-clicking on a UGrid shows the **Extrude Down to 3D UGrid** command. If the UGrid has 2D cells, this command can be used to create a new UGrid with 3D prismatic cells. The user can specify the number of layers and the thickness of each layer.

3D → 2D

If the UGrid has 3D cells, this command brings up a dialog asking for the layer number from which a UGrid consisting of 2D cells will be created.

UGrid Structure, Prior to GMS 10.2

A UGrid can keep track of the geometric structure it was generated from. The structure can control the editing operations that are allowed and how they are performed on the UGrid. The structure of a UGrid is shown in the UGrid Properties dialog.

- *Quadtree* structure is used for grids that were either converted from a 2D or 3D grid or were created using as a Regular, Quadtree, or Nested UGrid.
- *Voronoi* structure is used for grids created using Voronoi option in the *Map → UGrid* dialog. For the outer cells of a Voronoi UGrid the computational centroid of the cell is along the outer edge to maintain the right angle connection between cells when generating the MODFLOW UDIS package file.
- *Unknown* structure is used for all other UGrids.

Constraints (previously "UGrid Structure")

A UGrid is a general purpose unstructured grid that can have a variety of cell types. In GMS, we apply some structure to unstructured grids in the form of "constraints". The UGrid's constraint determines the types of cells and the editing operations that are allowed and how they are performed on the UGrid. The constraint of a UGrid is shown in the *UGrid Properties* dialog.

- *Quadtree* – Used for grids that were either converted from a 2D or 3D grid or were created using as a Regular, Quadtree, or Nested UGrid. Cells can be refined but not deleted or created and cell boundaries cannot be moved. Points cannot be added, deleted, or moved.
- *Voronoi* – Used for grids created using Voronoi option in the *Map → UGrid* dialog. For the outer cells of a Voronoi UGrid the computational centroid of the cell is along the outer edge to maintain the right angle connection between cells when generating the MODFLOW UDIS package file. Cells cannot be refined or deleted or created and cell boundaries cannot be moved. Points cannot be added, deleted, or moved.
- *2D* – Used for 2D surfaces such as a TIN, mesh, or simply as points without cells. This is the default when creating a new UGrid by clicking points in plan view, and when

importing points from a text file and specifying "UGrid Points 2D". Points can be triangulated to form cells and cells can be deleted. Points can be added, deleted, and moved.

- *None* – No constraint. Used for all other UGrids. Points can be triangulated to form cells and cells can be deleted. Points can be added, deleted, and moved.



Cell Refinement

UGrid cells can be refined by selecting the cells, right clicking on them, and selecting the *Refine* menu item. A new copy of the UGrid will be generated with the selected cells refined. The cells will be refined based on the structure of the UGrid. For a UGrid with quad tree structure a cell is refined by adding an additional level of quadtree refinement. Voronoi structured UGrid cells can only be refined by permanently changing the grid structure to Unknown. For a UGrid with unknown structure, a 3D cell is refined by adding a node at the middle of each horizontal edge along with a new node at the center of the top and bottom faces.

Deleting Points and Cells

Selected UGrid points and cells can be deleted by hitting the *Delete* key if the current UGrid [constraint](#) allows it.

Lock to Prevent Editing / Unlock for Editing

In order to prevent accidental editing of a UGrid, such as dragging a selected point, UGrids can be "locked" and "unlocked". They typically start out locked when they are created, and when locked, no editing is allowed. To unlock the UGrid, simply right-click on the   UGrid in the Project Explorer and select the **Unlock for Editing** command. This command changes to say **Lock to Prevent Editing** when the UGrid is unlocked, allowing the user to lock the UGrid and thus prevent further editing.

Triangulate

UGrid points can be triangulated to form a Delauney triangulated irregular network, or TIN, by right-clicking on the UGrid and selecting the **Triangulate** command. If any cells exist they will be deleted and new triangle cells will be created.

UGrid Viewing Modes

The UGrid module contains two viewing modes unique to the module.

Single Layer View

UGrid cells can be assigned to a layer. The layer for the cell is displayed in the [Cell Properties](#) dialog. The *Single layer* toolbar can be used to view one layer at a time. This is somewhat analogous to the 3D grid ortho mode but works for all viewing angles.

This toolbar can be turned on or off by using the *Display | Toolbars | UGrid Single Layer* menu command.



Symbols On Top

When cell faces are turned on, or color filled contours which result in a filled face, the symbols which are normally displayed at the cell centroid are displayed at the center of the top face of the cell. This allows them to be seen, although the symbol may still be partially obscured by the filled cell face.

Converting UGrids to Other Data Types

UGrids cannot currently be converted to other data types (TINs, meshes, etc.).

UGrids can be converted from 2D to 3D by using the **Extrude Down to 3D Grid** command.

Converting from 3D to 2D is done using the **3D → 2D** command.

UGrids can be exported to various file types. See the article [Exporting UGrids](#).

Exporting UGrids

UGrids can be exported to a file by right-clicking on the UGrid item in the [Project Explorer](#) and selecting the **Export** command. The supported file formats are:

Format	Description
VTK Binary XML File (*.vtu)	Format
VTK ASCII XML File (*.vtu)	Format
VTK ASCII Legacy File (*.vtk)	Format
Grid Specification File (*.gsf)	Used by PEST and mod-PATH3DU
Polygon Shapefile with MODFLOW Data (*.shp)	The 2D polygons formed by the cells in plan view (elements should be prismatic).
Point Shapefile with MODFLOW Data (*.shp)	The centroids of the cells.
Polygon Shapefile (*.shp)	The 2D polygons formed by the cells in plan view (elements should be prismatic).
Point Shapefile (*.shp)	The UGrid points.
TOUGH2 MESH File (*.*)	Used by TOUGH2.

UGrid Interpolation

UGrid [datasets](#) can be interpolated to other UGrids similar to how scatter point datasets can be interpolated to other objects. The **Interpolate To** command is found in the right-click menu of the UGrid dataset to be interpolated to another UGrid. This command opens the *Interpolation Options* dialog:

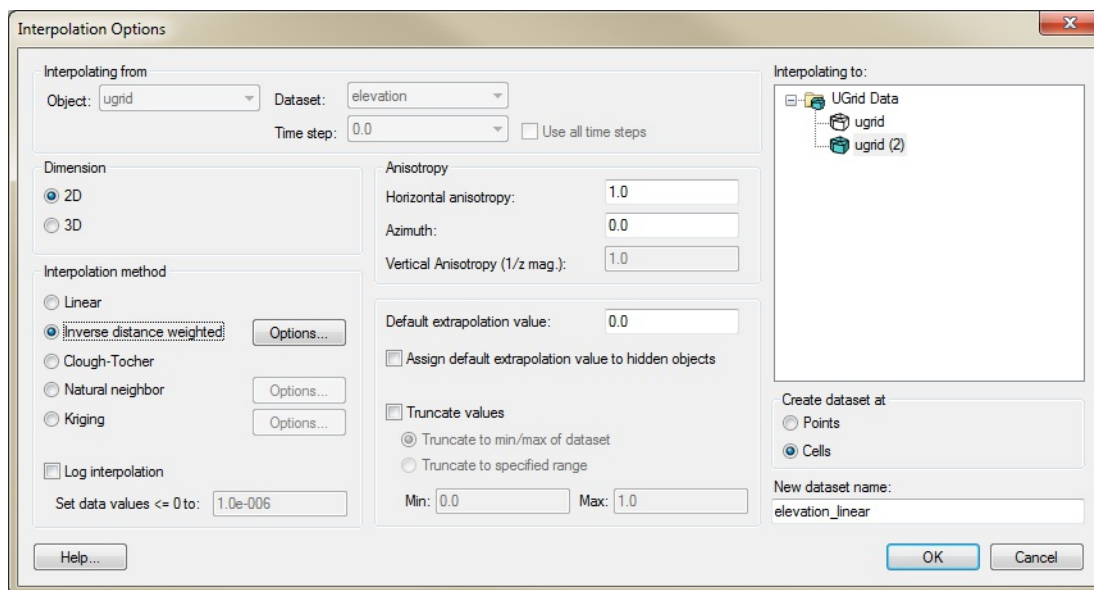

This dialog allows selecting the interpolation options to use, and the UGrid to interpolate to. See [Interpolation](#) for more information on interpolation. Options include:

- *Interpolating from* – This section gives information on the dataset being interpolated to the new dataset.
 - *Object* – Shows the dataset being used for the interpolation.
 - *Dataset* – Shows the type of dataset being used for the interpolation.
 - *Time step* – If the dataset being used has time steps, shows which time step is being used.
 - *Use all time steps* – If there are time steps, this option will interpolate all time steps in the source dataset.
- *Interpolating to* – This data tree shows all objects that can receive the interpolated data. Select the object that will receive the new interpolated dataset.

- **Dimension** – Options in this section determine whether the interpolation will be two-dimensional or three dimensional.
 - *2D* – Designates the interpolation as two-dimensional data. All interpolation methods are available with this option.
 - *3D* – Specified the interpolation as three-dimensional data. Only the inverse distance weighted and Kriging options are available with this method.
- **Anisotropy** – Options in this section allow taking into account for directional tendencies in the original dataset.
 - *Horizontal anisotropy*
 - *Azimuth* – Sets angle of degrees between the projected vector and a reference vector on the reference plane.
 - *Vertical Anisotropy (1/z mag)* – Available with the 3D option. Vertical anisotropy is 1 over the Z scale.
- **Interpolation method** – This section specifies which **interpolation process** will be used.
 - *Linear* – Uses data points that are first triangulated to form a network of triangles.
 - *Inverse distance weighted* – Creates an interpolated surface that is a weighted average of the point data; the weight assigned to each point diminishes as the distance to the interpolation location increases. The **Options** button next to this option will bring up either the *2D IDW Interpolation Options* dialog or the *3D IDW Interpolation Options* dialog.
 - *Clough-Tocher* – A finite element method that has origins in the finite element method of numerical analysis.
 - *Natural neighbor* – Based on the Thiessen polygon network of the point data. The **Options** button next to this option will bring up the *Natural Neighbor Options* dialog.
 - *Kriging* – Based on the assumption that the parameter being interpolated can be treated as a regionalized variable. The **Options** button next to this option will bring up the *Kriging Options* dialog.
 - *Log interpolation* – Takes the log of each data value in the active dataset prior to performing interpolation.
 - *Set data value ←0 to* – Assigns a value to points where the current data value is less than or equal to zero. Typically, a small positive number should be used.
- **Default extrapolation value**
- **Assign default extrapolation value to hidden objects** — Assigns the default extrapolation value to all cells that are hidden using the **Hide** command in the *Display | Visibility* menu.
- **Truncate values** – This section allows for limiting the interpolated values to lie between the minimum and maximum value.
 - *Truncate to min/max of dataset* – Limits the interpolated values to the minimum and maximum values in the original dataset.



- *Truncate to specified range* – Allows setting a user specified minimum and maximum value range.
- *Min* – Manually sets a minimum value.
- *Max* – Manually sets a maximum value.
- *Create dataset at* – Specifies where the new dataset will be located: at the points or at the cells.
 - *Points* – Specifies the new dataset will be located at the points.
 - *Cells* – Specifies the new dataset will be located at the cells.
- *New dataset name* – Assigns a name to the new dataset created from the interpolation process.

It is also possible to drag a UGrid dataset and drop it on to another UGrid to open this dialog and to indicate what the interpolation target should be.

Points vs. Cells

UGrids can have datasets associated with both cells and points. Thus there is an option to specify where the new dataset will be located: at the points or at the cells.

UGrid Display Options

The display options of UGrid data that GMS displays on the screen can be controlled through the *UGrid Data* tab of the *Display Options* dialog. This dialog is opened by right-clicking on the  "UGrid Data" item in the *Project Explorer* and selecting the **Display Options** command. It can also be accessed from the *Display* menu or the **Display Options**  macro. The following table describes the display options available for the UGrid module.

Display Option	Description
Cell edges	The Cell edges item is used to display the edges of cells. The cells are drawn using the specified color.
Cell faces	This option fills the cells with the material color.
Cell centers	This option displays a point at the center of every cell.
Points	Points are the corners of cells, or simply 3D points not attached to cells. A symbol can be displayed at these locations. If Point contours are on, the color of the symbol will be determined by the data and the contour options.
Inactive points	Show points that correspond with an inactive dataset value.
UGrid shell	The UGrid shell item is used to display an edge for each of the edges on the exterior of the set of all cells (visible or invisible) which corresponds to a discontinuity in the UGrid exterior. This display option provides a helpful spatial context when displaying isosurfaces or cross sections.
Feature angle	The UGrid shell feature angle is used only when the <i>UGrid Shell</i> option is selected. This angle represents a threshold angle at which an edge of the shell will be displayed. If for example, an angle of 45 degrees is defined, any edge of the UGrid which divides two cell faces that are at an angle greater than 45 degrees to each other will not be displayed.
Point numbers	The Point numbers item is used to display the ID associated with each point next to the point.
Cell numbers	The cell numbers item is used to display the ID associated with each cell at the centroid of the cell.
Scalar values	The Scalar Values item is used to display the scalar values of the active dataset for each node next to the node.
Face contours	Most of the objects supported by GMS can be contoured by turning on the Contour Options in the <i>Display Options</i> dialog. When an object is contoured, the values associated with the active dataset for the object are used to generate the contours.
Point contours	The same Contour Options but applied to points.
Vectors	Vector arrows are displayed using the active vector dataset.
Isosurfaces	Isosurfaces are the 3D equivalent of a contour line. An isosurface is a surface of constant value extracted from a 3D dataset.
Clip	Creates a clipping widget that can be used to hide part of the UGrid. Clicking the Options button will bring up the <i>UGrid Clip Settings</i> dialog. The options include setting the widget to be a plane, which can be manipulated with the mouse in the Graphics Window, or to be a scalar or scalar range, which work like isosurfaces. Whole cells or partial cells can be clipped.
Copy Display Options to UGrid(s)	The current UGrid <i>Display Options</i> can be copied to other UGrids. This button brings up a dialog to select the UGrids that the <i>Display Options</i> will be copied to.

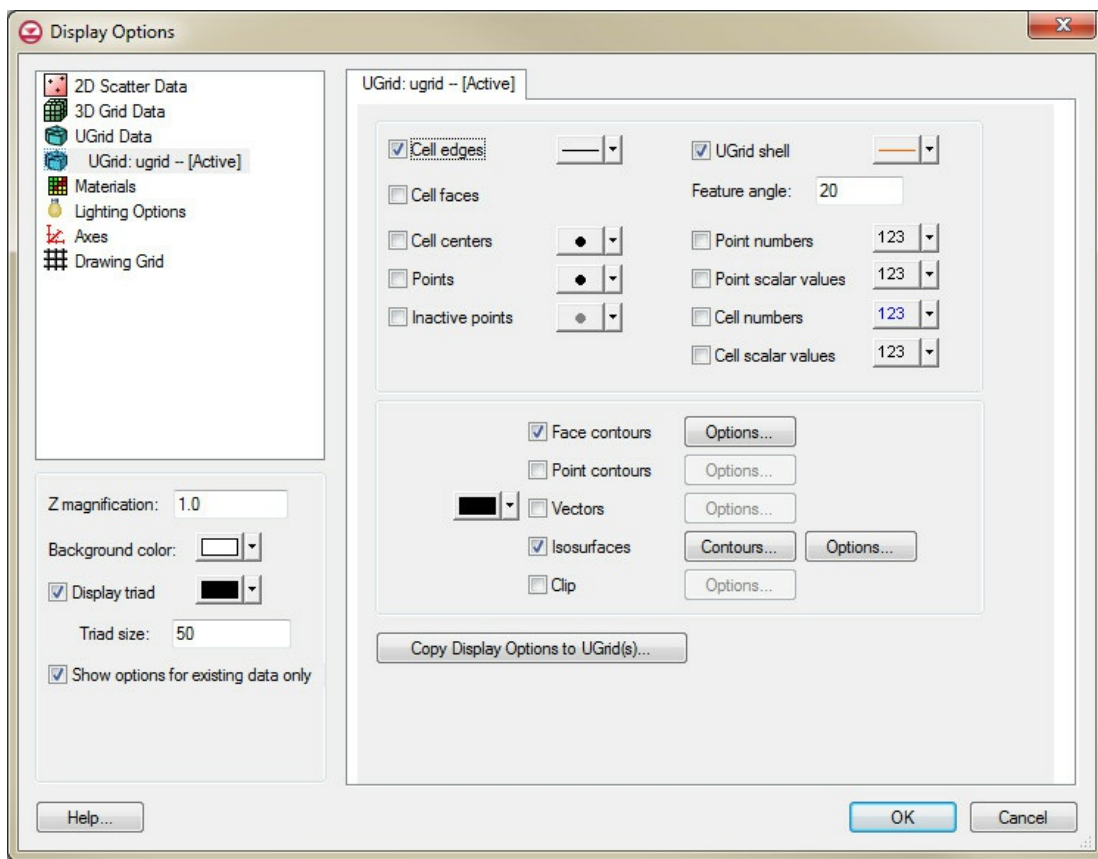

The Display Options dialog showing the 3D UGrid tab.

UGrid Clip Settings

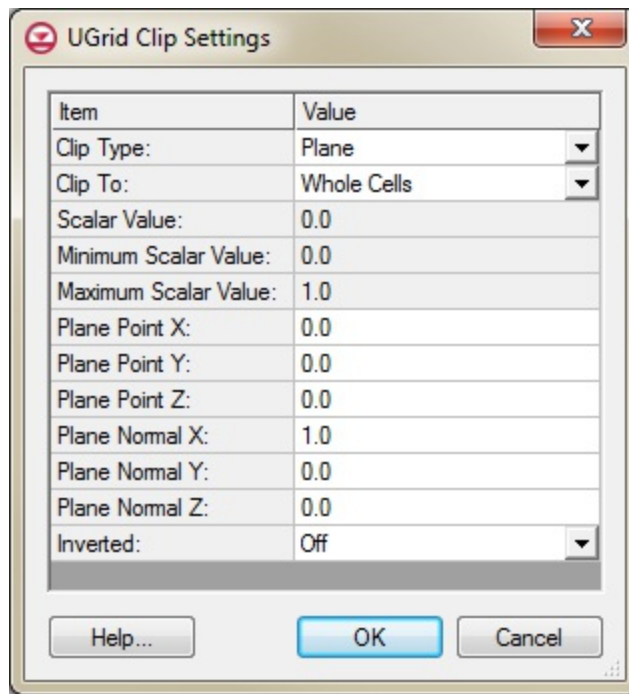

The UGrid Clip Settings dialog

The *Ugrid Clip Settings* dialog allows setting parameters for clipping the UGrid display. The dialog has the following options:

- *Clip Type* – Can be set to "Plane", "Scalar", or "Scalar Range".
 - "Plane" – Defines a clipping plane that cuts through the Ugrid. Allows the **Edit Clip Plane** tool to be used.
 - "Scalar" – Defines the clipping area based on a single value.
 - "Scalar Range" – Defines the clipping area based on a minimum and maximum value.
- *Clip To* – Set the clipping to use "Whole Cells" or "Partial Cells".
- *Scalar Value* – Creates a clipping region based on the set scalar value.
- *Minimum Scalar Value* – The lowers scalar value for the clipping range.
- *Maximum Scalar Value* – The highest scalar value for the clipping range.
- *Plane Point X* – Defines the location on the X axis of the the central clipping point.
- *Plane Point Y* – Defines the location on the Y axis of the the central clipping point.
- *Plane Point Z* – Defines the location on the Z axis of the the central clipping point.
- *Plane Normal X* – Determines the X value used in the plane calculation.

- *Plane Normal Y* – Determines the Y value used in the plane calculation.
- *Plane Normal X* – Determines the Z value used in the plane calculation.
- *Inverted* – The clipping area will be inverted when this option is set to "On".

UGrid Tool Palette

The following tools are contained in the dynamic portion of the [tool palette](#) when the [UGrid module](#) is active. Only one tool is active at any given time. The action that takes place when clicking in the [Graphics Window](#) depends on the current tool.

Select Cells

Used to select individual UGrid cells. Multi-selection can be performed by holding down the *Shift* or *Ctrl* key while selecting or by dragging a rectangle to enclose the cells to be selected. The xyz locations of the cell centroid of the selected cell are displayed in the [Edit Window](#) and the ID and other information is displayed in the [Status Bar](#).

Only visible cells can be selected. Cells which have been hidden cannot be selected. Cells where the MODFLOW IBOUND array equals 0 can only be selected when they are being displayed by turning on the *IBOUND = 0* item in the [MODFLOW Display Options](#) dialog.

When selecting cells by dragging a box, all cells that lie within the box are selected. When selecting cells by clicking on individual cells with the cursor, only cells on the exterior of the visible portion of the grid are selected. Cells in the interior of the grid can be selected individually by first hiding the layers, rows, or columns adjacent to the cells.

Selected cells can be deleted by right-clicking and selecting **Delete** or by pressing the *Delete* key.

Select Points

Used to select points which, if connected to cells, are the corners of cells. The point coordinates are displayed in the [Edit Window](#). Selected points can be deleted by right-clicking and selecting **Delete** or by pressing the *Delete* key.

Select Particles

Used to select particles generated at wells.

Create Points

Used to interactively create points in the UGrid by clicking in the GMS graphics window.

Merge/Split

When selected, clicking on a triangle edge with the mouse cursor will cause the two triangular elements adjacent to the edge to be merged into a quadrilateral element provided that the quadrilateral shape formed by the two triangles is not concave.

The **Merge/Split** tool can also be used to undo a merge or to "unmerge" a quadrilateral element. A quadrilateral element can be split into two triangles by clicking anywhere in the interior of the element. This tool is useful if a pair of triangles are inadvertently merged.

Swap Edges

If the **Swap Edges** tool is selected, clicking on the common edge of two adjacent triangles will cause the edge to be swapped as long as the quadrilateral shape formed by the two triangles is not concave.

Occasionally, it is useful to interactively or manually swap the edges of two adjacent triangles. This can be thought of as a quick and simple alternative to adding breaklines to ensure that the edges of the triangular elements honor a geometrical feature that needs to be preserved in the mesh.

Edit Clip Plane

When *Clip* is turned on in the *Display Options* dialog and the *Clip Type* is "Plane" in the [UGrid Clip Settings](#) dialog, this tool can be used to manipulate the location and orientation of the clipping plane, which is used to hide part of a UGrid and create a cutaway view.

UGrid Cell Properties

The *UGrid Cell Properties* dialog allows editing cell properties. Most cell properties are associated with a model such as MODFLOW-USG. If no models exist in the GMS project then the *UGrid Cell Properties* dialog will only allow editing of the material assigned to the grid cell.

MODFLOW

Several input arrays defining parameters such as starting head, [IBOUND](#), hydraulic conductivity, and transmissivity are defined in the [Global/Basic](#) and [BCF](#) or [LPF](#) packages. These arrays can be edited in the Basic and BCF/LPF/HUF Package dialogs, or they can be initialized using a [conceptual model](#) in the [Map module](#). In many cases however, it is necessary to view or edit the values on a cell-by-cell basis. This can be accomplished using the ***Cell Properties*** command in the drop-down menu when selecting UGrid cells.

NOTE: When using materials to define the MODFLOW model, the *Cell Properties* dialog will show the material properties relating to the material of the selected cell. It is not possible to edit these values on a cell-by-cell basis, but it is possible to either edit the material type for this cell if the active material set is the default material set, or change the material properties for the material (which affects every cell that uses that material).

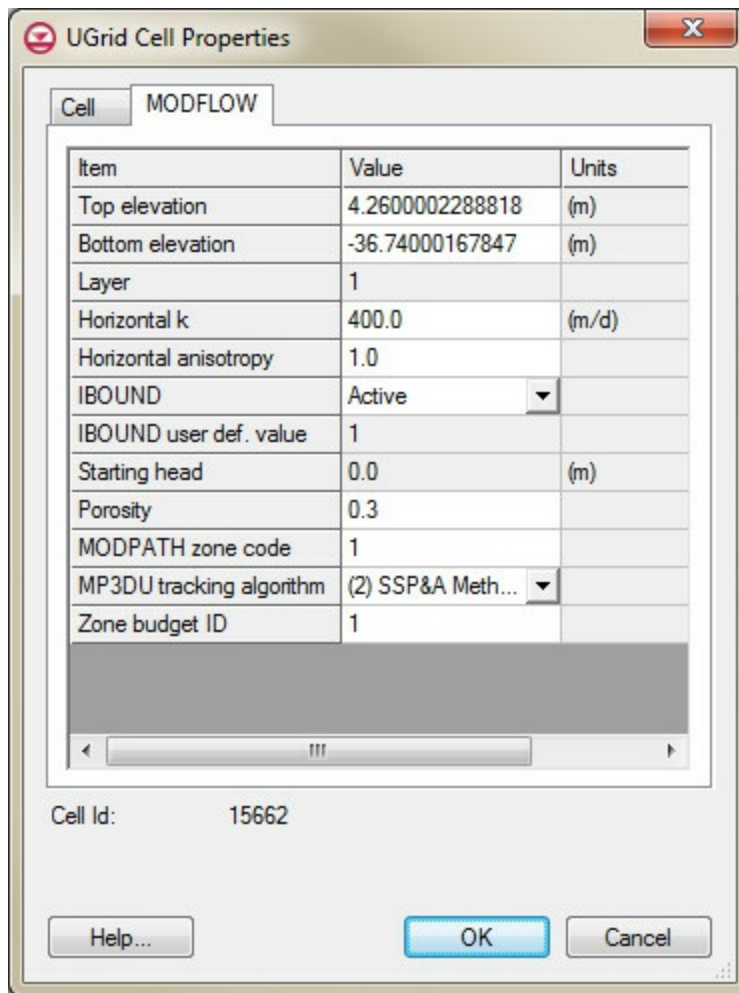

3D Grid Cell Properties dialog showing the MODFLOW tab.

UGrid Commands

Various menu commands are available when right-clicking on UGrid items in the Project Explorer.

Project Explorer

New Empty UGrid 2D...

Creates a new UGrid object in the Project Explorer. This UGrid will initially have no parameters or properties set. This allows properties and parameters to be defined at a later time. Elevation data can be interpolated to the UGrid.

New UGrid 2D...

Brings up the [New UGrid](#) dialog.

New UGrid 3D...

Brings up the [New UGrid](#) dialog.

UGrid in Project Explorer

Right-clicking on a UGrid item in the Project Explorer provides the following menu commands:

New MODFLOW

Creates a new MODFLOW simulation.

Export...

Brings up a dialog that allows [exporting the UGrid](#) to a file.

Triangulate

[Creates triangles](#) from existing vertices on the active TIN using the Delauney criteria. If triangles already exist, they will be deleted.

Isosurface Volumes

Extrude Down To 3D UGrid...

Brings up a dialog allowing you to specify layer thicknesses to [create a 3D UGrid from](#)

a 2D UGrid.

3D → 2D...

Creates a UGrid with 2D cells from a specified layer of a 3D UGrid.

Zoom To Extents

Frames the Graphics Window around the selected objects.

Unlock/Lock to Prevent Editing

[Can be turned on or off to allow editing](#). When in the locked status, cells and points cannot be deleted nor can triangulated elements be split, merged, or swapped. By default a ugrid is locked when first created.

Properties

Brings up the *UGrid Properties* dialog.

UGrid Dataset

Right-clicking on a UGrid dataset brings up the following commands:

Z Values → Dataset

Creates a dataset from the Z locations of the cells or points. Only for 2D UGrids.

Map to Z Values

Moves the cell or point Z locations to the values in the dataset. Only for 2D UGrids.

Convert to Node Dataset

Converts a cell centered dataset to a node dataset. Node dataset values are assigned by averaging the connected cells.

Convert to Cell Dataset

Converts a node dataset to a cell centered dataset. Cell dataset values are assigned by averaging the connected nodes.

Interpolate to

Brings up the *Interpolation Options* dialog. The data object to interpolate to is selected in this dialog.

Interpolate to Raster

Opens the *Interpolate to Raster* dialog.

Properties

Opens the *Dataset Info* dialog.

Related Topics

- [UGrid Module](#)

6. Models

6.1 FEFLOW

FEFLOW

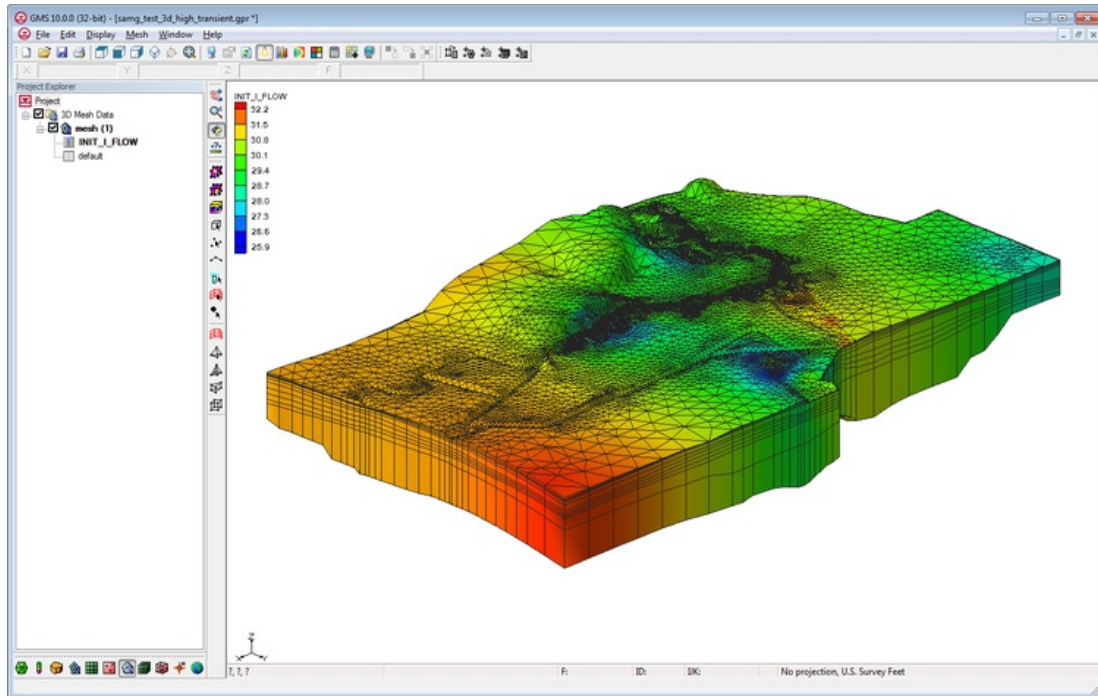

Imported FEFLOW mesh example

GMS can import and export **2D** and **3D** finite element meshes using the **FEFLOW ASCII Model File Format** (*.fem). This makes it possible to build a mesh in GMS and export it so it can be used to build a model in FEFLOW. Also, the mesh from a FEFLOW model can be exported from FEFLOW and imported into GMS for viewing, examination and post-processing.

The mesh geometry and nodal datasets in the *.fem file are imported and exported. FEFLOW boundary conditions and material properties on elements are not imported or exported.

Import

To import a FEM file into GMS, use the **File | Open** command. Change the *Files of type* to *.fem (or *.*). Alternatively, simply drag and drop the file onto the GMS

program window.

Export

To export a 2D or 3D mesh from GMS to a FEM file, right-click on the mesh in the [Project Explorer](#) and select the **Export** command.

FEFLOW Files

The structure of the FEFLOW model file consists of a variable number of statements. The number of statements necessary to describe a FEFLOW model depends on the problem class and optional model properties. The first six statements and the last statement have fixed positions in the file. The last statement has to be the END statement. The other statements can be in any order. Most of the statement types have to be unique in the FEFLOW model file.

A GMS tutorial on FEFLOW does not exist, but a sample FEFLOW *.fem file that can be read in to GMS can be found by downloading the file [FeflowSample1.zip](#) from Aquaveo.

External Links

- [FEFLOW Website](#)
- [FEFLOW Manual](#)

6.2. FEMWATER

FEMWATER

GMS includes a graphical interface to the FEMWATER (Finite Element Model of Water Flow Through Saturated-Unsaturated Media) model. FEMWATER is a 3D finite element, saturated/unsaturated, density driven, flow and transport model. FEMWATER was originally written by G.T. (George) Yeh at Penn State University (Yeh, et. al., 1992). The version of FEMWATER that is supported by GMS has been modified by G.T. Yeh and Dr. Hsin-Chi (Jerry) Lin of the U.S. Army Engineer Waterways Experiment Station (WES). This version is a coupled version of the original FEMWATER model (which solved for flow only) with the transport model LEWASTE (also developed by George Yeh).

A separate reference manual is available which describes the new version of FEMWATER in detail (Lin, et. al., 1997). This manual contains a description of the input requirements and should be read completely before using GMS to set up a problem.

GMS provides a [custom interface](#) to the FEMWATER model offering a simple way to set model parameters and a graphical user interface to run the model then [visualize the results](#). FEMWATER allows modeling of salinity intrusion and other density-dependent contaminants. Complex stratigraphy can be developed in GMS and directly represented in the model. Solutions can be displayed using realistic 3D plots and animation sequences.

The FEMWATER model can be added to a [paid edition](#) of GMS.

FEMWATER Output Files

Here are tables of some of the available output files for FEMWATER.

- For more information on these files see the manual.

Output Files

Name	Description
3BC	Boundary Conditions
3DM	3D Mesh Information
CON	Convergence Data
FLX	Nodal Boundary Flux
FWS	FEMWATER Super File
INF	Temporary Setup Information
MCN	Moisture Content
OUT	Model Output
PHD	Initial Point Heads
TMP	Temporary Data
VEL	Velocity Data

Pre-Processing

- [Building a FEMWATER Model](#)
- [FEMWATER Model Input](#)
- [Saving a FEMWATER Simulation](#)

Post-Processing

- [FEMWATER Display Options](#)
- [FEMWATER Post-Processing Viewing Options](#)

External Links

- [FEMWATER Manual](#)
- Donnell, Barbara P. "DDJC-Sharpe Defense Distribution Depot: FEMWATER 3D Transport Model Study of Pumping and No Pumping Effect on TCE Plume Migration with Natural Attenuation." No. ERDC/CHL-CHETN-XI-1. Engineer Research and Development Center Vicksburg MS Coastal and Hydraulics Lab, 2004.[\[1\]](#)

FEMWATER Commands

The *FEMWATER* menu becomes available after a FEMWATER simulation has been created. Below the commands in this menu:

New Simulation...

Starts a new FEMWATER simulation. This command will delete any existing FEMWATER data running in GMS.

Delete Simulation...

Removes the selected FEMWATER simulation.

Check Simulation...

Starts the *Model Checker* dialog.

Run FEMWATER...

Executes the FEMWATER model.

Read Solution...

Opens a FEWATER solution file.

Geometry File...

Opens the *Geometry File* dialog where preferences for saving geometry files can be set.

Titles...

Brings up the *FEMWATER Geometry and Model Title Cards* dialog. See [Titles](#) for more information.

Run Options...

Opens the *FEMWATER Run Options* dialog. See [Run Options](#) for more information.

Initial Conditions...

Opens the *FEMWATER Initial Conditions* dialog. See [FEMWATER Initial Conditions](#) for more information.

Iteration Parameters...

Brings up the *FEMWATER Iteration Parameters* dialog. See [Iteration Parameters](#) for more information.

Particle Tracking...

Opens the *FEMWATER Particle Tracking* dialog. See [Particle Tracking Parameters](#) for more information.

Time Control...

Opens the *FEMWATER Time Control* dialog. See [Time Control Parameters](#) for more information.

Output Control...

Brings up the *FEMWATER Output Control* dialog. See [Output Control](#) for more information.

Fluid Properties...

Opens the *FEMWATER Fluid Properties* dialog. See [Fluid Properties](#) for more information.

BC Display Options...

Brings up the [Display Options](#) dialog showing the *FEMWATER* tab.

Variable BC Options...

Opens the *Variable BC Options* dialog.

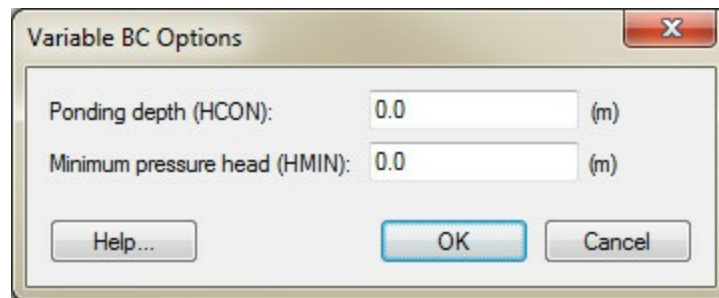

The Variable BC Options dialog.

Assign Node/Face BC...

Either assigns a new boundary condition or edits an existing boundary condition to a selected set of boundary nodes or boundary element faces. See [Assign Node/Face BC](#) for more information.

Point Source/Sink BC...

Assigns a flow rate to a node. See [Point Source/Sink BC \(Wells\)](#) for more information.

Delete BC

Removes selected boundary condition.

Related Topics

- [FEMWATER](#)

6.2.1. FEMWATER Pre-Processing

Building a FEMWATER Model

Three various approaches provided in GMS for constructing a FEMWATER model. The model can be completely defined using the tools in the [3D Mesh module](#) (the direct approach), or the model can be defined with the aid of the feature object tools in the [Map module](#) (the conceptual model approach). A horizons to 3D mesh approach can also be used.

Basic Steps in Building a FEMWATER Model

The basic steps in building a FEMWATER model include:

- Build a 3D mesh defining the extents of the model. Three approaches are available:
 - [FEMWATER Direct Approach](#)
 - [FEMWATER Conceptual Model Approach](#)
 - [Horizons to 3D Mesh](#)
- Initialize FEMWATER
- Assign boundary conditions and model stresses, including sources and sinks
 - [Point Source/Sink BC \(Wells\)](#)
 - [Assign Node/Face BC](#)
- Assign material properties
- Run FEMWATER

FEMWATER Direct Approach

For models with simple geometry and boundary conditions, the entire model can be constructed using the tools and commands in the 3D Mesh module. With this approach, the editing of the FEMWATER data is performed directly on the nodes and elements of the mesh. The first step is to create a 3D mesh covering the model domain using the mesh

building tools in the 3D Mesh module. The boundary conditions and source/sink terms are then assigned by [selecting nodes](#), [elements](#), and [element faces](#) and assigning values directly to the selected objects. The model is then saved and FEMWATER is launched.

Creating a Mesh

The first step in performing a FEMWATER simulation is to create a 3D finite element mesh. The volumetric domain to be modeled by FEMWATER is idealized and discretized into hexahedra, prisms, tetrahedra, and or pyramids. Elements are grouped into zones representing hydrostratigraphic units. Each element is assigned a material ID representing the zone to which the element belongs. When constructing a mesh, care should be taken to ensure that elements do not cross or straddle hydrostratigraphic boundaries.

The tools provided in GMS for constructing a 3D finite element mesh are provided in the 3D Mesh Module. When constructing a mesh for FEMWATER, there are a few important guidelines that should be considered. These guidelines are described in Chapter 3 of the FEMWATER reference manual.

The most efficient method for constructing a 3D mesh for FEMWATER is to use the conceptual model approach. The FEMWATER conceptual model can be used to automatically build a 2D mesh that matches the model boundaries and is refined around wells. This mesh can then be [extruded into a 3D mesh](#).

Solids can also be used to make a structured mesh. This is accomplished with the [Solids → Layered Mesh](#) command in the *Solids* menu.

FEMWATER Conceptual Model Approach

The preferred method for setting up a FEMWATER simulation is to use the feature object tools in the [Map module](#) to define a FEMWATER conceptual model of a site being studied. The conceptual model is a high-level description of the site including sources/sinks, the boundary of the domain to be modeled, rainfall and seepage zones, and material zones within each of the layers. The conceptual model is defined with [feature objects](#), including points, arcs, and polygons, and is constructed independently of a numerical grid. Once the conceptual model is complete, a mesh is automatically constructed to fit the conceptual

model, and the FEMWATER data are converted from the conceptual model to the nodes, elements, and element faces. The dialogs and interactive editing tools in the FEMWATER menu can then be used to edit or review the data if desired.

A FEMWATER model can be created in GMS using one of two methods: assigning and editing values directly to the nodes and elements of a mesh (the direct approach), or by constructing a grid-independent representation of the model using feature objects and allowing GMS to automatically assign the values to the nodes and elements (the conceptual model approach). Except for simple problems, the conceptual model approach is typically the most effective.

The conceptual model approach utilizes [feature objects](#) in the [Map module](#). A FEMWATER conceptual model is created in the Map module and feature objects are used to create a high level representation of the site being modeled. The figure below shows a sample conceptual model.

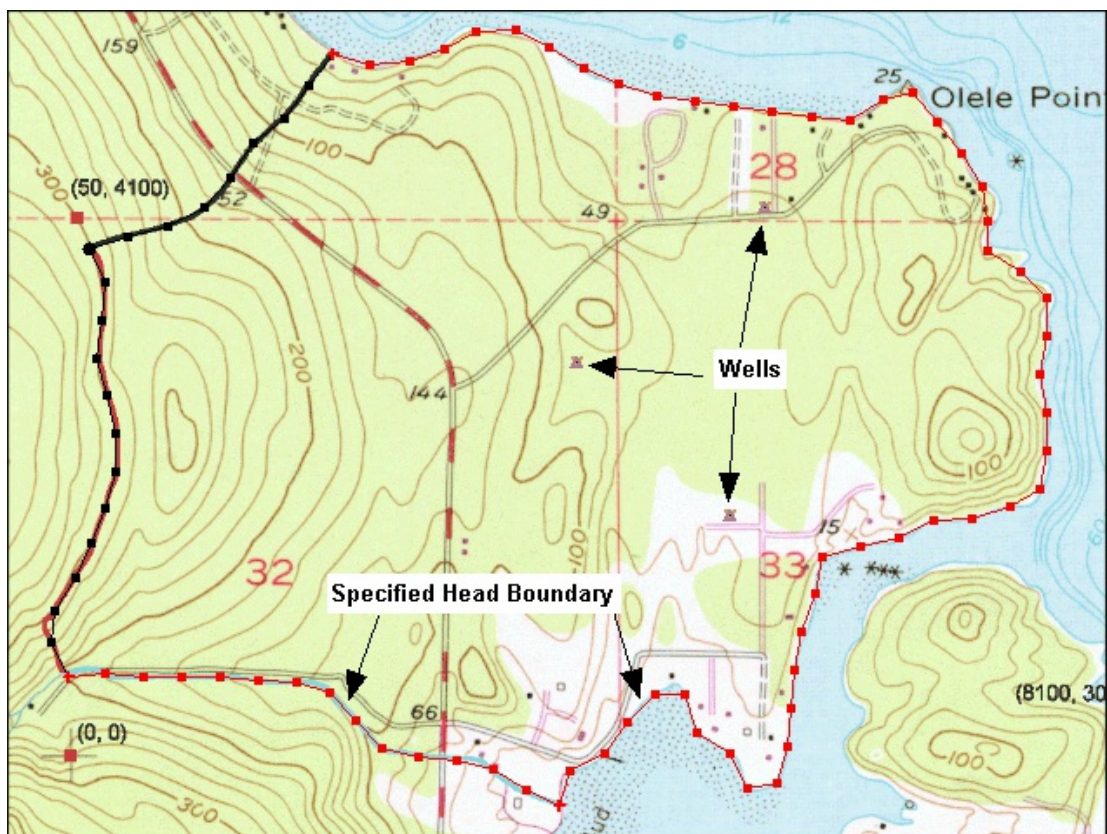



Sample FEMWATER conceptual model

Two Step Process

A FEMWATER conceptual model is used to build a numerical model using a two step process:

1. In the first step, a 3D mesh is created. This can be done by using the feature objects in conjunction [with a set of TINs to build a 3D mesh](#) or a solid can be converted to a layered 3D mesh using the **Solids → Layered Mesh** command.
2. In the second step, the boundary conditions and recharge values assigned to the feature objects are automatically assigned to the appropriate nodes and element faces of the 3D mesh using the *Feature Objects* | **Map** → **FEMWATER** command.

To create a FEMWATER conceptual model:

1. Right-click on the " Map Data" folder in the [Project Explorer](#) and select the **New Conceptual Model** command.
2. In the *Conceptual Model Properties* dialog change the model type to FEMWATER in the pull-down list. In the dialog the simulation options of flow and transport can also be toggled on or off.
3. Next create a [coverage](#) by right-clicking on the FEMWATER conceptual model  in the data tree and selecting **New Coverage**.
4. The coverage attributes can then be setup in the *Coverage Setup* dialog.

A FEMWATER coverage can contain points, arcs, and polygons. The points are used to define wells, the arcs are used to define boundary conditions, and the polygons are used to define recharge zones. In most cases, a single coverage is sufficient. However, multiple FEMWATER coverages can be used if desired.

More on point/arc properties here: [FEMWATER Point / Arc Properties](#)

Build a 3D Finite Element Mesh

Once the FEMWATER conceptual model is constructed, the next step is to use the conceptual model to build a 3D finite element mesh. This is accomplished by first building a 2D mesh, then building the 3D mesh by extruding each of the 2D elements in 3D elements.

Map → 2D Mesh

The first step in building the 3D mesh is to select the *Feature Objects* | **Map → 2D Mesh** command. This command creates a 2D mesh by automatically filling in the interior of the conceptual model with nodes and elements. The size and spacing of the elements is controlled by the spacing of the vertices on the arcs and by the refine point attribute assigned to any wells in the interior of the conceptual model.

An example of the **Map → 2D Mesh** command is shown in the following figure. A sample FEMWATER conceptual model is shown in part a. The 2D mesh resulting from execution of the **Map → 2D Mesh** command is shown in part b.

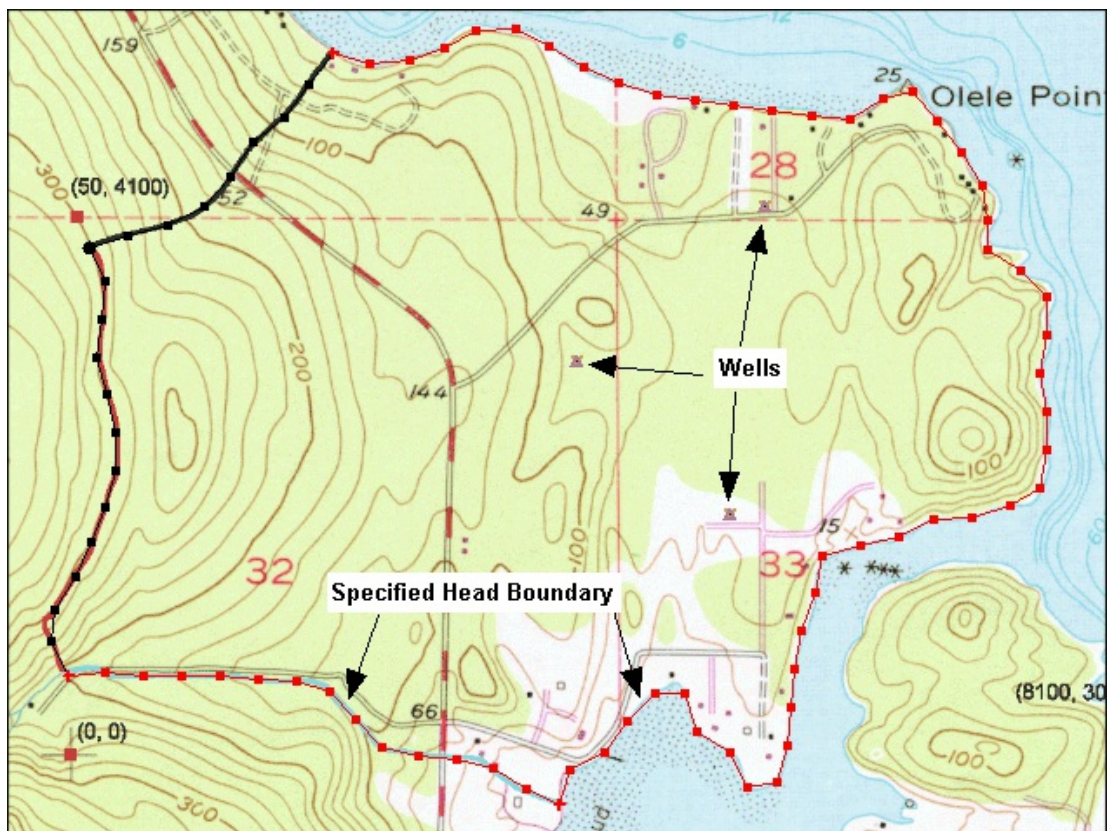

(a) Converting a FEMWATER conceptual model: conceptual model.

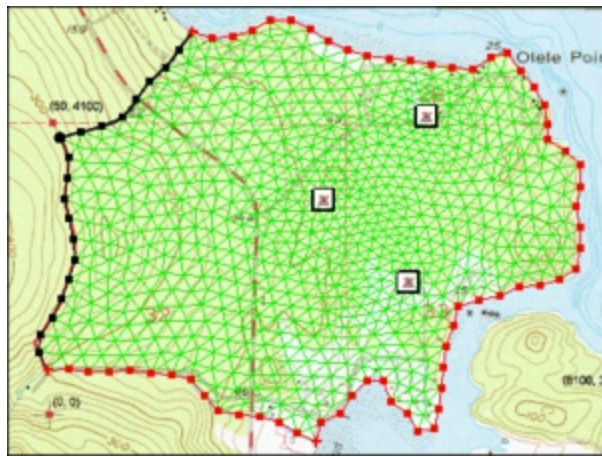

(b) Converting a FEMWATER conceptual model: 2D mesh created with **Map**
→ **2D Mesh** command.

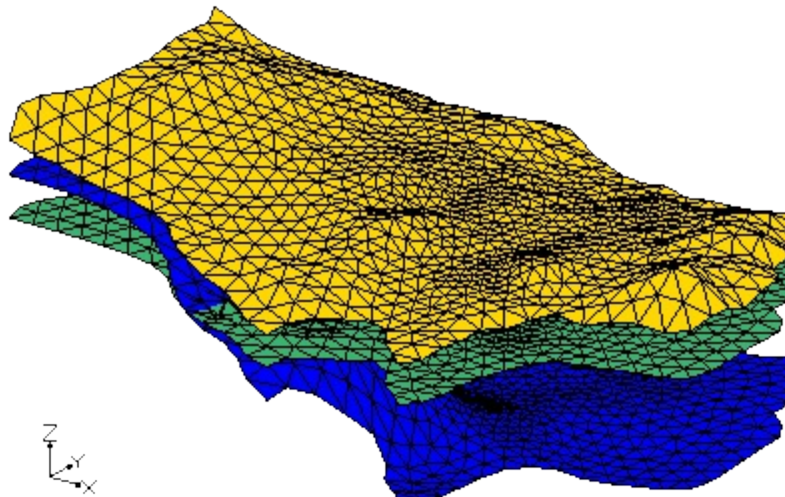

(c) Converting a FEMWATER conceptual model: TINs created from a 2D
mesh.

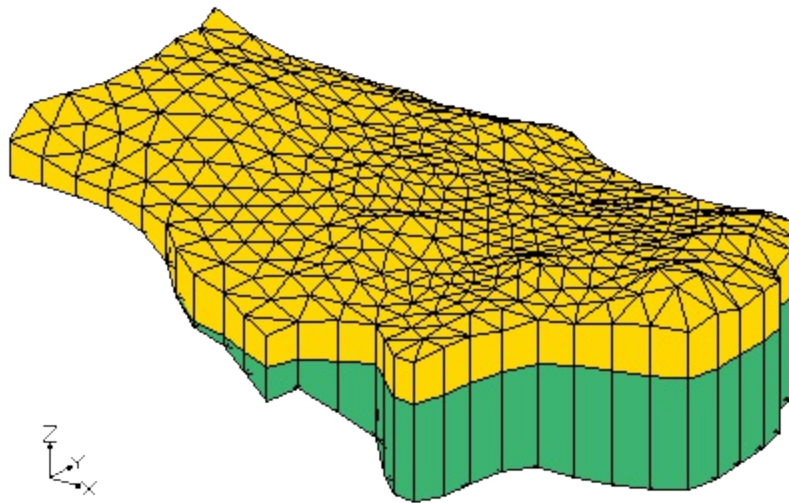

(d) Converting a FEMWATER conceptual model: 3D mesh created from TINs.

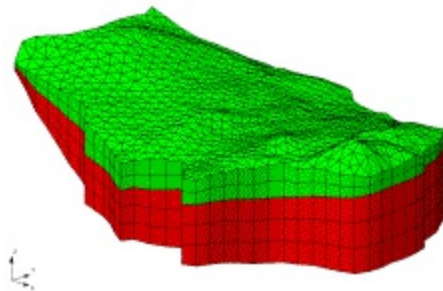

(e) Converting a FEMWATER conceptual model: 3D mesh after running FEMWATER.

Creating the 3D Elements

Once the 2D mesh is created, the next step is to create the 3D mesh by extruding each of the 2D elements into a series of 3D elements. The elevations of the 3D elements can be defined from a set of boreholes, a set of TINs, or a set of Solids.

For sites with relatively simple stratigraphy, the **Regions → 3D Mesh** command in the Borehole module can be used.

For sites with more complex stratigraphy, the **TINs → 3D Mesh** command in the TIN module should be used.

A mesh can also be created using the **Solids → Layered Mesh** command in the Solid module.

FEMWATER Flows

Computed flows can be automatically summed and displayed for FEMWATER simulations. To enable this option, the *Save flux file (*.flx)* option must be selected in the *FEMWATER Output Control* dialog prior to saving the FEMWATER model. When this option is selected, FEMWATER saves a lumped nodal flow dataset file as part of the FEMWATER solution. This file is automatically read into GMS as part of the FEMWATER solution.

Once a FEMWATER flux file (*.flx) has been read into memory as part of a FEMWATER solution, the computed flux through a set of nodes can be displayed simply by selecting the nodes. The flow budget (in, out, net) for the selected nodes is displayed in the *Status Bar* at the bottom of the GMS window. The flow budget is only displayed if the active solution is a FEMWATER solution.

It should be noted that lumped nodal fluxes are only non-zero for boundary nodes where a boundary condition has been assigned.

Point Source/Sink BC (Wells)

The **Point Source/Sink BC** command is used to assign a flow rate to a node. This option is typically used to assign flow rates to interior nodes to simulate injection or extraction wells. When a point source/sink is first assigned to a node, the node should be selected with the **Select Nodes** tool. The **Point Source/Sink BC** command is then selected and the *Point Source/Sink BC* dialog appears. Both a flow rate and a concentration may be specified at a point source/sink node. The values can be constant or transient.

Existing boundary conditions can be deleted by selecting the boundary condition with the **Select Boundary Nodes**, **Select Boundary Faces**, or **Select Wells** tool and selecting the **Delete BC** command from the *FEMWATER* menu.

The Select Well Tool

When a point source/sink boundary condition is applied to a node, a well symbol is placed on the node. The **Select Wells** tool can then be used to select the node rather than the **Select Nodes** tool whenever the well needs to be edited or deleted. The **Select Wells** tool is easier to use than the **Select Nodes** tool when there are a large number of nodes since it only selects nodes with point source/sink boundary conditions.

Assign Node/Face BC

The **Assign Node/Face BC** command in the *FEMWATER* menu is used to either assign a new boundary condition or edit an existing boundary condition to a selected set of boundary nodes or boundary element faces. The dialog that appears depends on whether nodes or faces are selected.

Nodal Boundary Conditions

If a set of nodes is selected when the **Assign Node/Face BC** command is selected, the *Node BC* dialog appears. Boundary conditions assigned to nodes correspond to Dirichlet boundary conditions. Both head and concentration can be specified.

Head

Head boundary conditions in FEMWATER are assigned as total head. FEMWATER converts the total heads to pressure heads internally. Heads can be specified as a constant value or as a transient value (curve of head vs. time).

The **Load Dataset** button can be used to assign the head values from a dataset. For example, if the elevation dataset is selected, the head is set equal to the node elevation at each of the selected nodes.

Concentration

The concentration can also be specified as either a constant or transient value. Since the concentration is a Dirichlet boundary condition, it represents a fixed concentration at the node. It does not represent the concentration of the incoming fluid.

Face Boundary Conditions

If a set of faces is selected when the **Assign Node/Face BC** command is selected, the *Face BC* dialog appears. Boundary conditions assigned to faces are flux-type boundary conditions. Both flux and concentration can be assigned independently. In both cases, the type must be designated as either variable, flux (Cauchy), or flux gradient (van Neumann).

The value can be defined as a constant or transient value.

Existing boundary conditions can be deleted by selecting the boundary condition with the **Select Boundary Nodes**, **Select Boundary Faces**, or **Select Wells** tool and selecting the **Delete BC** command from the *FEMWATER* menu.

FEMWATER Point / Arc Properties

Point Properties

Points in a FEMWATER coverage are used to define injection and extraction wells. The point attributes are edited via the *Point Properties* dialog. The *Point Attributes* dialog is accessed by [selecting a point\(s\)](#) and then selecting the **Attribute Table** command in the coverage right-click option menu. Each point's properties are displayed in the spreadsheet. The options in the dialog are as follows.

- *Type* – The type of point can be changed to either a well or an observation point. These options are available depending on what was selected in the *Coverage Setup Dialog*. The type for each point is defaulted to "NONE" in the *Type* column pull-down list.
- *Refine* – If the Refine mesh around point option is selected, the edge length of the elements surrounding the node are set to the size entered in the Element size edit field when the 2D projection mesh is generated. (see: [Map → 2D Mesh](#))
- *Wells* – To define a point as a extraction or injection well change the *Type* to "well" in the spreadsheet. For each well, a flow rate and a concentration can be assigned. Each well is also assigned a the top and bottom elevation of the screened interval.
- The screened interval is used to determine which of the nodes in the 3D mesh are used to represent the well in the numerical model. When the [Map → FEMWATER](#) command is selected, all nodes intercepted by the well screen are found and each node is marked as a point source/sink (a well node). The flow assigned to the well in the conceptual model is distributed to the mesh nodes using the logic illustrated below. A length of influence on the well screen is found for each node and the flux assigned to the node is proportional to the length of influence divided by the total screen length.

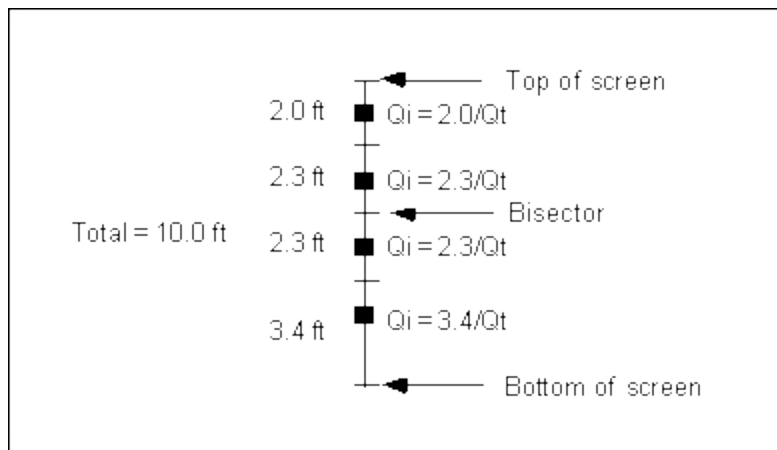

The distribution of flux rate to nodes overlapped by well screen.

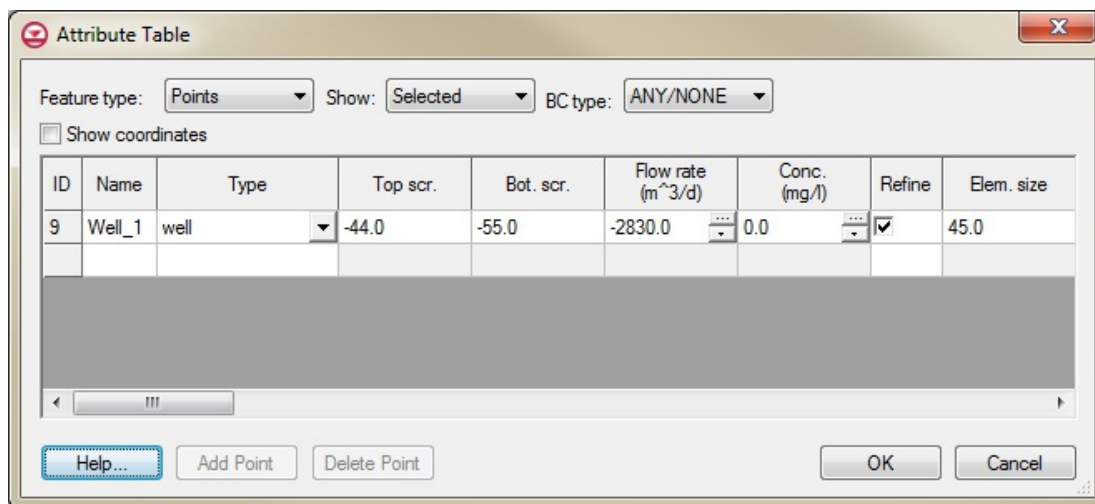

Example of the FEMWATER point Attribute Table dialog

Arc Properties

Arcs in a FEMWATER coverage are used to define the model boundary and the boundaries of recharge zones. Arcs on the outside boundary of the model can also be used to specify boundary conditions. Boundary conditions are assigned using the FEMWATER arc *Attributes Table* dialog. The *Arc Properties* dialog is accessed selecting the **Attribute Table** command in the coverage right-click option menu. The options for arc attributes are as follows:

- *Flow bc* – The *Flow bc* option is used to define a specified head or specified flux boundary. If this option is selected in the drop-down list. The available options are:

- *Specified head* – If this option is selected, a head value is assigned to each of the two nodes at the endpoints of the arc. If the two values at the endpoints are different, the head is assumed to vary linearly along the arc length. When the **Map → FEMWATER** command is selected, all nodes on the boundary of the mesh beneath the arc are found and the nodes are marked as specified head nodes. A linearly interpolated head value is assigned to each node.
 - *Specified flux* – If this option is selected, a flux value is assigned to the arc in the Flux rate column of the spreadsheet. When the **Map → FEMWATER** command is selected, all vertical element faces on the boundary of the mesh beneath the arc are found and the specified flux rate is assigned to the faces.
 - *Variable flux* – If this option is selected, a flux value is assigned to the arc. When the **Map → FEMWATER** command is selected, all vertical element faces on the boundary of the mesh beneath the arc are marked as variable boundary faces. If a flux value of zero (the default value) is assigned, the element faces represent a seepage face boundary where below the water table, the head is set equal to the elevation.
- *Contaminant* – The *Contaminant* option is used to model concentration or mass flux boundary conditions. This option is selected in the *Transport bc* column in the spreadsheet. The available options are:
 - *Specified concentration* – If this option is selected, a concentration value is assigned to the arc using the *Concentration flux* column. When the **Map → FEMWATER** command is selected, all mesh nodes on the boundary of the mesh beneath the arc are found and the specified concentration is assigned to the nodes.
 - *Specified mass flux* – If this option is selected, a mass flux value is assigned to the arc using the Mass flux column. When the **Map → FEMWATER** command is selected, all vertical element faces on boundary of the mesh beneath the arc are found and the specified mass flux rate is assigned to the faces.
 - *Variable (concentration)* – If this option is selected, a concentration value is assigned to the arc using the *Concentration* column. When the **Map → FEMWATER** command is selected, all element faces on the boundary of the mesh beneath the arc are found and the specified concentration is assigned to the faces as a variable type boundary condition. Note that this boundary condition can be used in conjunction with any of the three options for specified head/fluid flux. The proper use of this type of boundary condition is explained in the [FEMWATER Reference Manual](#).
 - *Assigning to Zones* – The *Zone* column is used to determine how the boundary conditions are applied to the nodes and element faces when the **Map → FEMWATER** command is selected. By default, the boundary conditions are assigned to all nodes

and element faces beneath the arc. However, in some cases it is useful to restrict the boundary condition to only a portion of the vertical boundary beneath the arc. This can be accomplished by selecting the Selected zones only option and marking the material zones where the boundary condition is to be applied.

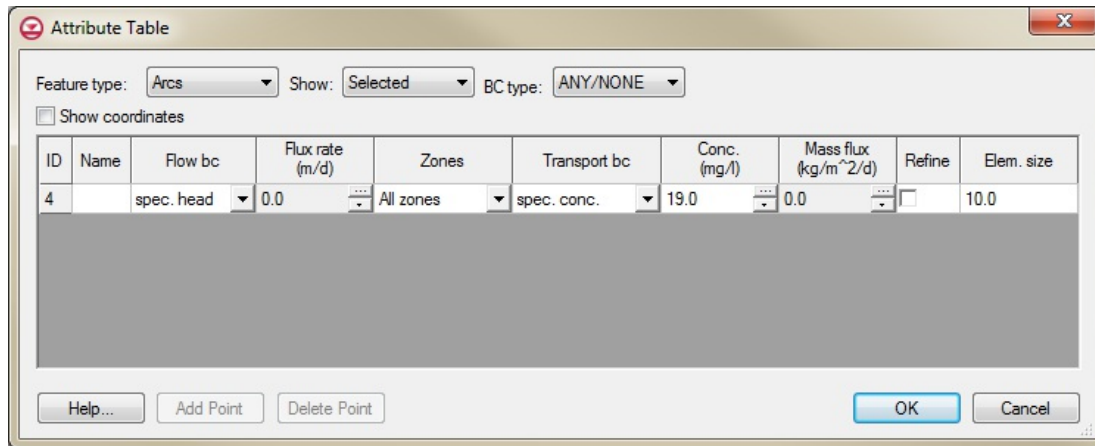

Example of the FEMWATER arc Attributes Table dialog

Node Properties

As explained in the previous section, if an arc is marked as a specified head arc, a head value must be assigned to the two nodes at the endpoints of the arc. This is accomplished using the *FEMWATER Node Attributes* dialog. The Arc Properties dialog is accessed by selecting a node and then selecting the **Attribute Table** command in the coverage right-click option menu. If the head values assigned to the two endpoints of an arc are different, the head is assumed to vary linearly along the length of the arc.

Polygon Properties

Polygons in a FEMWATER coverage serve two purposes: they define the model domain and they can be used to assign recharge values on a zonal basis. When building a FEMWATER coverage, the boundary of the model domain should be delineated using arcs. In order to use the coverage to build a 3D mesh, the arcs should be used to build one or more polygons defining the model domain using the **Build Polygon** command.

In addition to defining the model domain, a material ID and a recharge value can be assigned to polygons in the FEMWATER coverage using the *Polygon Properties* dialog. The polygon attributes are as follows:

- *Material* – The *Material* pull-down list can be used to associate a material with a polygon. When the **Map → 2D Mesh** command is selected, all 2D elements within the polygon are assigned the specified material. This material can be used to define the material type for the 3D elements when the 2D elements are extruded using the **Fill Between TINs → 3D Mesh** command.
- *Fluid Flux* – The *Fluid flux* option is used to assign a specified flux to the polygon. The flux can be assigned using either the *Specified flux* or *Variable flux* options. These options are set in the *Flow bc* drop-down list. When the **Map → FEMWATER** command is selected, all element faces on the top of the 3D mesh inside the polygon are found and the specified flux is assigned to the element faces.
- *Contaminant* – The *Contaminant* option is used to assign a mass flux or a concentration. If the *Specified mass flux* option is selected, the specified mass flux rate is assigned to all element faces on the top of the mesh when the **Map → FEMWATER** command is selected. If the *Variable (concentration)* option is selected, the specified concentration is assigned to all element faces inside the polygon.

FEMWATER Model Input

Several model parameters must be defined for a given FEMWATER simulation. In many cases the default values suffice. The following is a list of the required parameters:

Titles

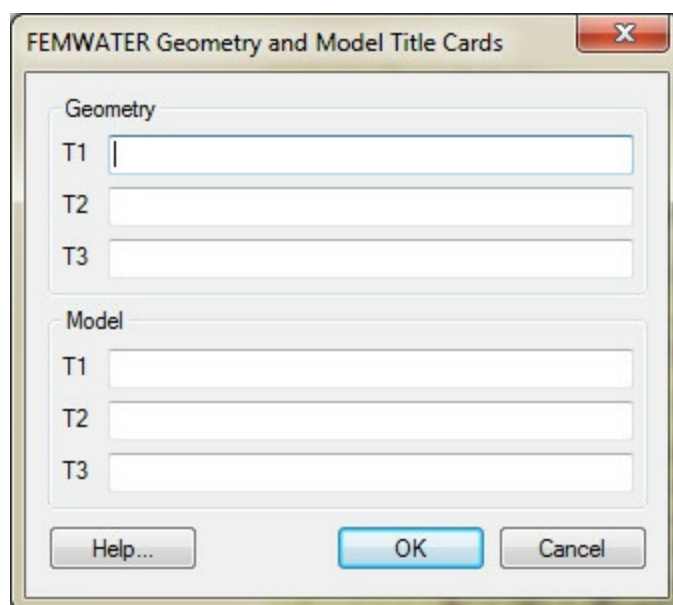

FEMWATER Geometry and Model Title Cards dialog

The **Titles** command in the *FEMWATER* menu is used to enter two sets of titles. Each set contains three lines of text. The first set is written to the top of the geometry file when the simulation is saved. The second set is written to the top of the model file.

Run Options

The *FEMWATER Run Options* dialog is used to set the simulation run parameters and to enter a set of general analysis options.

- *Type of Simulation* – Three options are available for designating the type of simulations to be performed by FEMWATER:

- "Flow only" – This option is used to perform a steady state or transient flow simulation.
 - "Perform a transport simulation only" – For this case, a steady state or transient flow simulation must be performed prior to the transport simulation. The results of this simulation (velocity and moisture content) are then input to FEMWATER as a flow solution [initial condition](#).
 - "Coupled flow and transport" – With a coupled flow and transport simulation, either density-dependent flow or density-independent flow can be simulated. This option is controlled by entering the appropriate parameters defining the relationship between concentration and density and concentration and viscosity. These parameters are entered in the *Fluid Properties* dialog.
- **Steady State vs. Transient** – FEMWATER can be run in either a steady state or transient mode. The steady state mode is only allowed when the *Flow only* option has been selected.
 - **Units** – The **Units** button brings up the [Units](#) dialog. This dialog is used to enter the units for length, time, concentration, etc. for the simulation. GMS uses the selected unit options to display the appropriate units next to each input edit field in the other FEMWATER dialogs.
 - **Other Options** – The remaining run options are described in the FEMWATER Reference Manual. In most cases, the default values are appropriate.

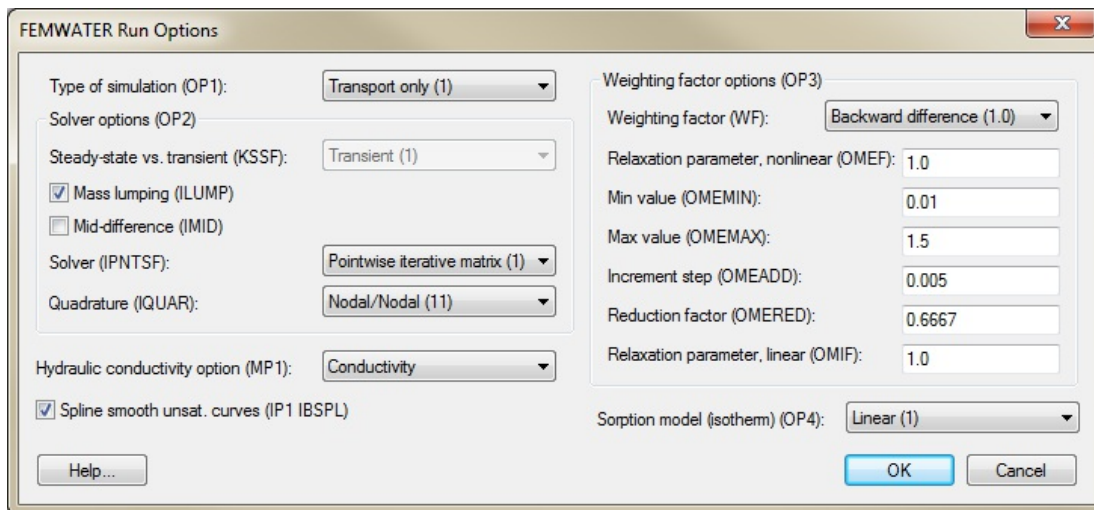

The FEMWATER Run Options dialog

Iteration Parameters

The *FEMWATER Iteration Parameters* dialog is used to enter the iteration parameters for

each simulation type (flow only, transport only, coupled flow and transport).

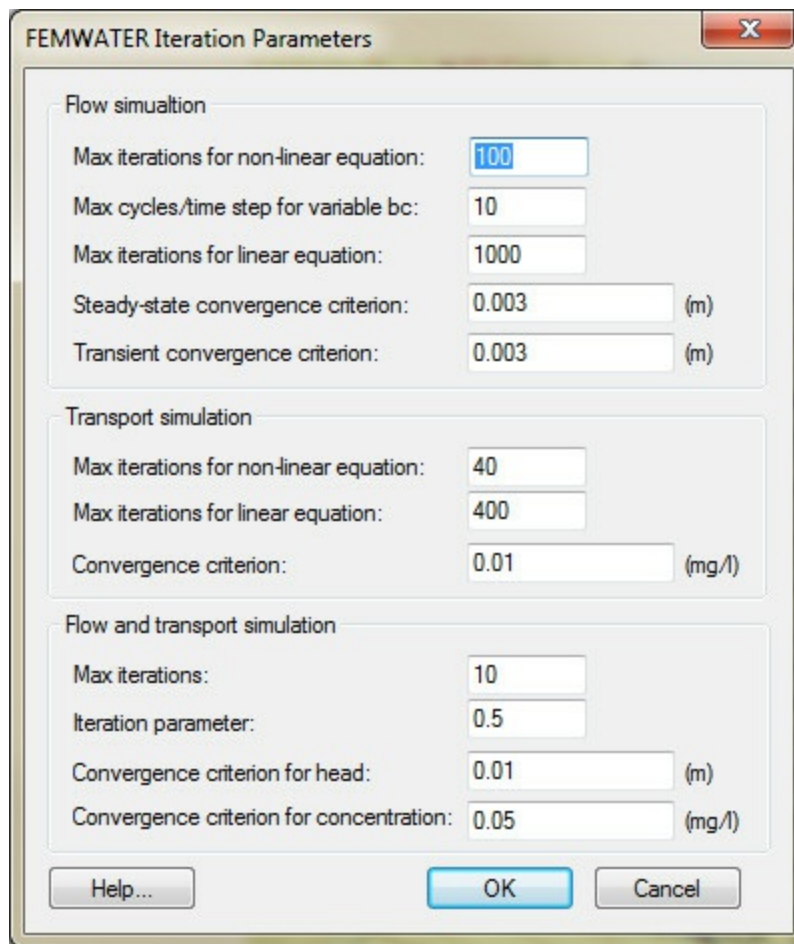

FEMWATER Iteration Parameters dialog

Particle Tracking Parameters

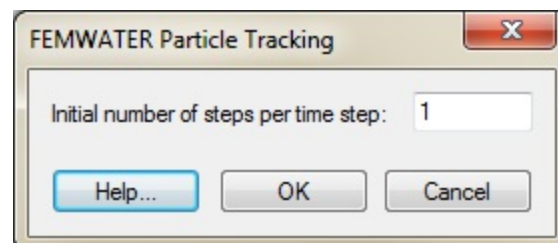

The FEMWATER Particle Tracking dialog

The *FEMWATER Particle Tracking* dialog is used to edit parameters relating to how the particle tracking is carried out by FEMWATER during the transport phase.

FEMWATER particle tracking refers to the algorithm used by FEMWATER to do advective transport. In GMS versions 6.5 and earlier there was another type of particle tracking available which was similar to [MODPATH](#) but for FEMWATER flow solutions. That functionality is documented on the [FEMWATER Particle Sets](#) page.

Page 32 of the FEMWATER manual describes the particle tracking used in advective transport. However the algorithm described is not actually used in the code. Instead a simpler adaptive time stepping algorithm is used. The parameter NXW is used as a "time step divisor" – backtracking begins by assuming a sub-time step, and every time backtracking fails, this sub-time step is divided by 2. NXW is used as an "Initial number of steps per time step" and the other parameters on the PT1 card are ignored.

Time Control Parameters

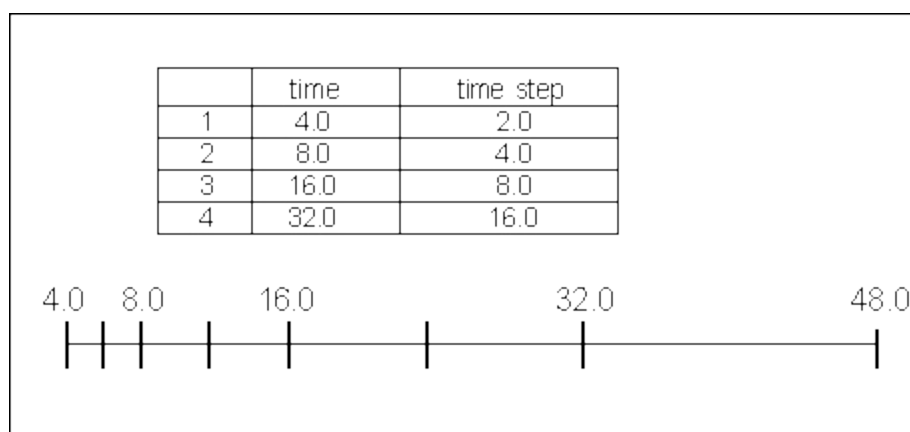

Timeline of computational time steps defined using the Variable Time Step option and the XY Series Editor.

The *FEMWATER Time Control* dialog is used to enter the data used by FEMWATER to compute the computational time intervals. It is also used to define the reference time. The options in the dialog are as follows:

Time Steps

There are two methods for defining the computational time steps: *Constant time step* and *Variable time step*. With the *Constant time step* method, the first time step is assumed to begin at time 0.0. A constant interval time is entered along with a maximum simulation time.

For example, if a constant time step of 2.0 is defined along with a maximum simulation time of 10.0, six computational time steps will be defined at 0.0 (the initial condition), 2.0, 4.0, 6.0, 8.0 and 10.0.

The *Variable time step* option permits variable intervals between time steps. Selecting the **Variable Times** button brings up the *XY Series Editor*. The *XY Series Editor* has one column for entering times and another for entering time steps. In the time column, the absolute time for a computational time step should be entered. The time step corresponding to each time represents the interval to be used from one specified time to the next.

A simple example of times and time steps defined in the *XY Series Editor* and the resulting computational time steps to be used by FEMWATER is shown below. In this case the maximum simulation time is equal to 48.0.

Output Control

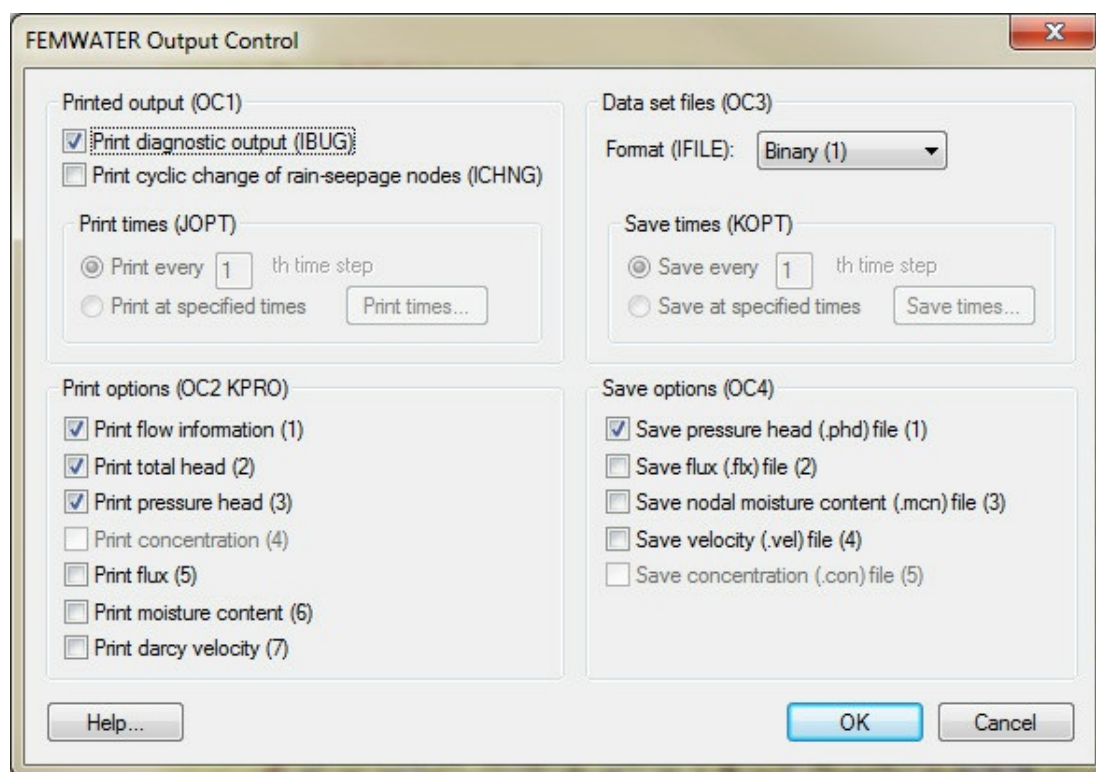

FEMWATER Output Control dialog

The *FEMWATER Output Control* dialog is used to enter parameters defining what type of output will be printed or saved from FEMWATER.

Printed Output File

The left side of the dialog controls what information is written to the printed output file. The printed output file is an ASCII file where the solution will be written.

Dataset Files

The results of a FEMWATER solution are GMS dataset files. The Dataset files portion of the dialog permits specification of what datasets will be saved and at what frequency. The solution dataset files are used as input to GMS to graphically visualize the results. [ASCII or binary solution file formats](#) may also be specified. In most circumstances, binary solution files should be specified, since they take up less memory and can be read more quickly by GMS.

Fluid Properties

The **Fluid Properties** command in the *FEMWATER* menu brings up the *FEMWATER Fluid Properties* dialog. This dialog is used to specify the acceleration of gravity and the density, viscosity, and compressibility of the fluid.

The **Edit Values** button brings up the *FEMWATER Fluid Coefficients* dialog. This button is undimmed when transport is being analyzed as part of the simulation.

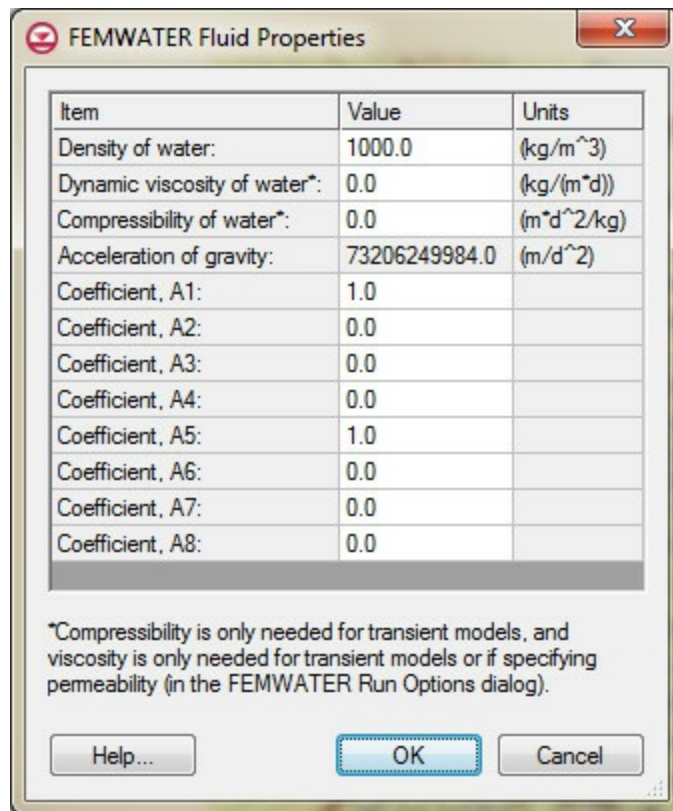

FEMWATER Fluid Properties dialog

Material Properties

As a 3D finite element mesh is constructed in GMS, a list of materials is defined and each element in the 3D mesh has a material type associated with it. The list of materials is initially created using the [Materials](#) dialog accessed through the *Edit* menu.

- K_{xx} , K_{yy} , K_{zz} , K_{xy} , K_{xz} , K_{yz} – The hydraulic conductivity tensor is defined via the K_{xx} , K_{yy} , K_{zz} , K_{xy} , K_{xz} , K_{yz} fields. Since the tensor is symmetric only the upper right half of the matrix can be specified.

Hydraulic Conductivity Tensor

K_{xx}	K_{xy}	K_{xz}
K_{yx}	K_{yy}	K_{yz}
K_{zx}	K_{zy}	K_{zz}

- *Moisture Content*, *Relative Conductivity*, *Water Capacity curves* – These unsaturated zone curves must be defined for each material. The curves can be defined using either

the *XY Series Editor* or the *Curve Generator* (discussed below). The *Curve Generator* is accessed via the **Generate Unsat Curves** button in the bottom of the dialog. When that button is selected, the curves that are generated will be associated with the active material, or the material in the spreadsheet row that currently has the focus.

Curve Generator

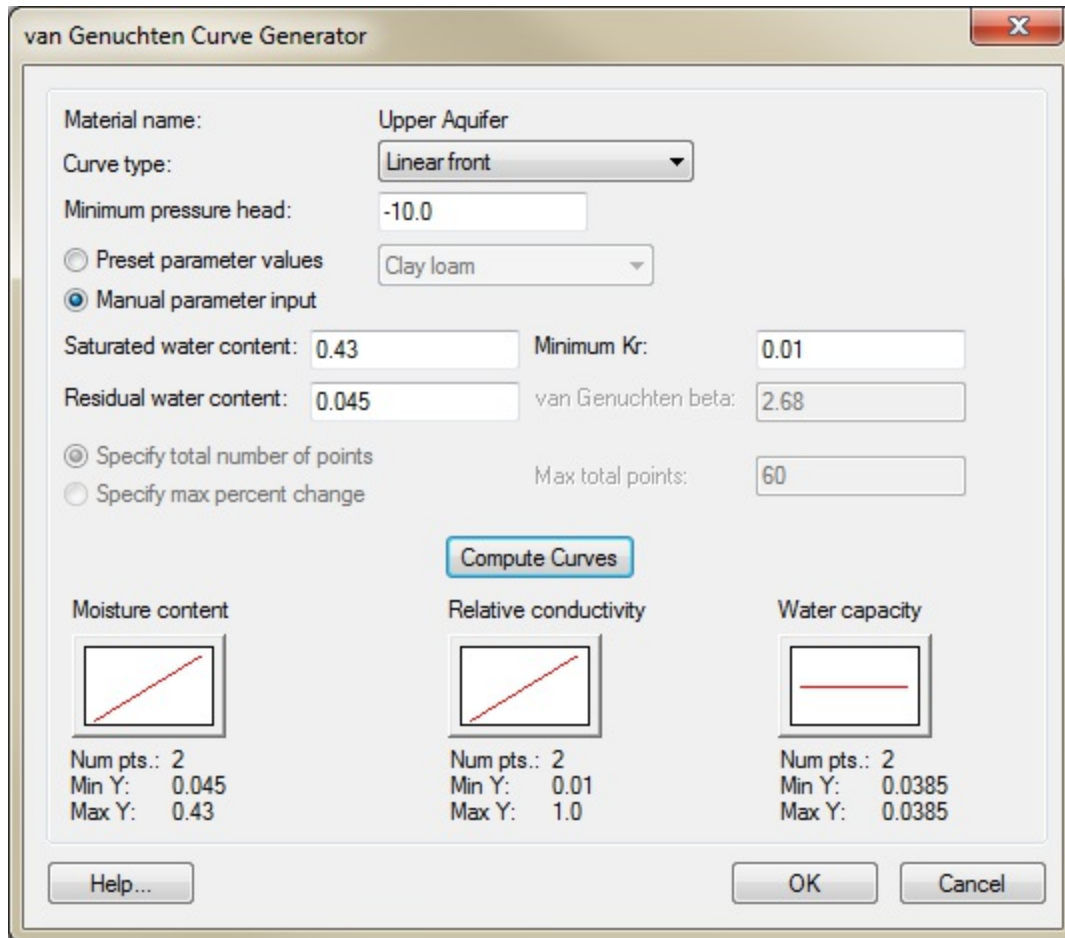

The FEMWATER Curve Generator dialog

In most cases, the simplest way to generate a set of pressure head curves for the unsaturated zone is to use the *Curve Generator*. The **Generate Unsat Curves** button brings up the *Curve Generator* dialog. This dialog is used to automatically generate a set of unsaturated zone curves using the van Genuchten equations described in the FEMWATER Reference Manual. The items in the top of the dialog are used to select the curve type ('linear front' or 'van Genuchten equation') and the max height of capillary rise above the water table. Two methods are available for entering the Van Genuchten parameters: (1)

selecting the *Manual parameter input* option and enter the values directly, or (2) selecting the *Preset parameter values* option and choose from a list of pre-defined soil types.

Once the parameters are defined the **Compute Curves** button can be used to generate a set of curves. The curves are displayed in the bottom of the dialog. New values can be entered and the process can be repeated until a satisfactory result is obtained. When the **OK** button is selected, the active curves are assigned to the current material.

Each of the unsaturated zone curves is a piece-wise linear curve defined by a sequence of points. The number of points in each curve is either specified by the user or determined automatically by specifying a *Max percent change*. If the **max percent change** option is used, a new point is added to the curve each time the parameter changes by the Max percent value.

Note that the effective porosity for each material is defined from the pressure head vs. moisture content curve. The value at $p = 0$ is taken from the curve and is written to the model file as part of the MP2 card.

Note also that GMS assumes that the van Genuchten 'alpha' value is entered in units consistent with the current model units. GMS displays the current model units next to the input field to help the user remember this.

FEMWATER Initial Conditions

Whenever a FEMWATER analysis is performed, a set of initial conditions must be defined. Initial conditions define the initial status of the pressure head and concentration. Three types of initial conditions are possible for a FEMWATER simulation: cold starts, hot starts, and flow solutions. Cold starts are used to establish a set of initial values at the beginning of a steady state or transient simulation. Hot starts are used to continue a previous run of FEMWATER without having to start over from the beginning. Flow solutions are used to define the flow field that is necessary when performing a transport only simulation (as opposed to coupled flow and transport). Initial conditions are described in more detail in Chapter 7 of the FEMWATER reference manual.

Initial conditions are defined using the *Initial Conditions* dialog. The available options are as follows:

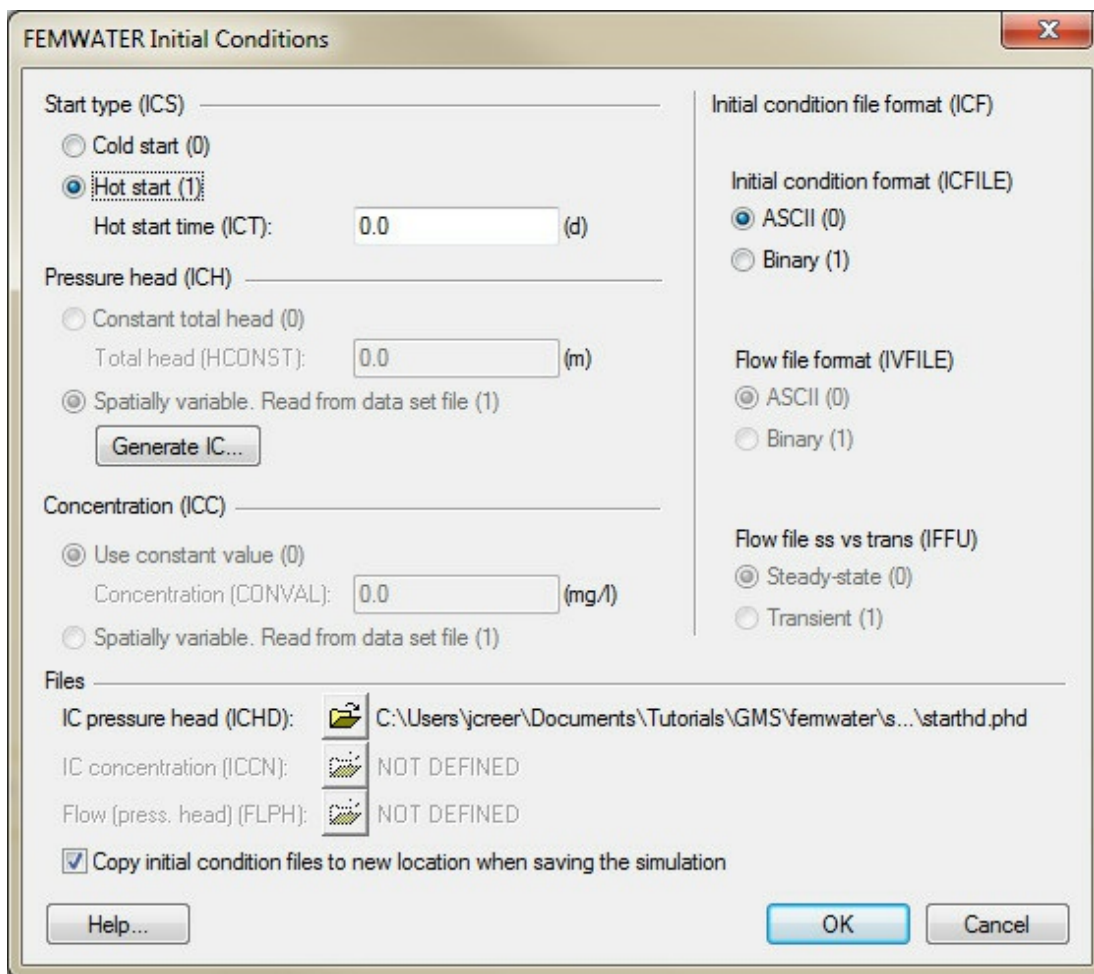

The FEMWATER Initial Conditions dialog.

Cold Starts

If a flow only simulation is performed, a set of pressure heads is required for the cold start initial condition. If a transport only simulation is performed, a set of concentrations is required (in addition to the flow solution as explained below). If a coupled flow and transport simulation is being performed, both heads and concentrations are required.

Pressure Head

Two options are available for designating a pressure head cold start initial condition. One option is to enter a constant value into the field labeled *Total head*. This essentially defines an initial condition corresponding to a flat water table. FEMWATER reads this value and internally generates an array of pressure heads by subtracting the nodal elevations from the given total head value.

The *Read from dataset file* option can be used to designate that the pressure head varies spatially and that the values will be read from a dataset file. If this option is selected, the name of the file must be entered at the bottom of the *Initial Conditions* dialog in the field titled IC pressure head. The dataset file is a standard GMS dataset file in either the ASCII or binary format. The dataset file can be generated using the interpolation options and then saved using the **Export Dataset** command accessed by right-clicking on the dataset file. However, a simpler approach to generating a well-posed initial condition is to use the **Generate I.C.** button. This button brings up the *Generate Pressure Head Initial Condition* dialog.

The first two items in the *Generate Pressure Head Initial Condition* dialog are used to select a 2D scatter point set and dataset. The scatter point set defines a set of elevations corresponding to a best estimate of the final computed water table elevation. A minimum pressure head may also be entered. When the **OK** button is selected, the elevations in the scatter point set are interpolated to the nodes of the 3D mesh. This defines a total head initial condition. The pressure head initial condition is computed by subtracting the node elevations from the total heads. The user is then prompted for a file name and the pressure head dataset is saved to a GMS dataset file and the path to the file is automatically written to the IC pressure head field at the bottom of the *Initial Conditions* dialog.

The pressure head cold start can have a significant influence on the speed of convergence. In some cases, a poorly defined initial condition may even prevent convergence. In most cases, the *Read from dataset file/Generate IC* option should be used since it results in a better initial condition.

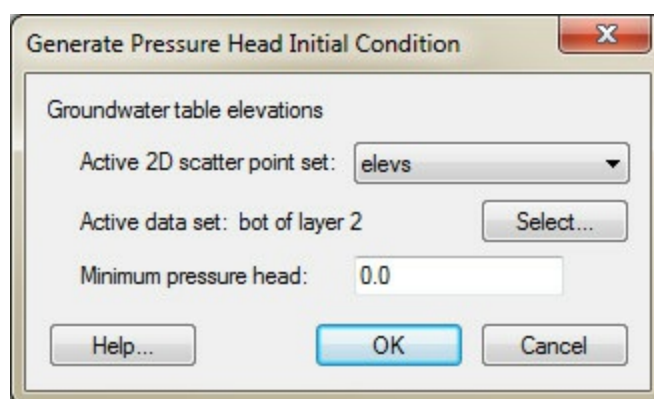

The Generate Pressure Head Initial Condition dialog.

Concentration

When defining a set of concentration values for a cold start initial condition, it is often useful to use a constant value of concentration everywhere in the problem domain. For example, in many cases, an initial condition of zero concentration everywhere in the problem domain is appropriate. The *Use constant value* option can be used to easily define a constant concentration for the entire mesh. If a constant value is not appropriate, the *Read from dataset file* option should be chosen. In this case, the initial condition varies spatially and the values are defined by a dataset file. This file can be created by interpolating concentrations to the mesh and saving the resulting dataset to a file using the **Export** command in the data tree. When this option is chosen, the name of the dataset file containing the concentration initial condition is entered in the *IC Concentration* field at the bottom of the *Initial Conditions* dialog.

Hot Start

Hot starts are used to begin a new simulation starting at a given time step of a solution computed from a previous transient simulation. If the *hot start* option is chosen, FEMWATER reads the specified hot start file and finds the time step corresponding to the specified time. The solution then begins using the dataset at that time as the initial condition.

The solution files necessary for a hot start depend on the type of simulation. If a flow only simulation is being performed, a pressure head file is required. If a transport only simulation is being performed, a concentration file is required (in addition to the flow solution described below). If a coupled flow and transport simulation is being performed, both pressure head and concentration are required. When the *Hot start* option is chosen, the names of the files used for the hot start are entered in the fields at the bottom of the *Initial Conditions* dialog.

If the *Hot start* option is chosen, the *Append to moisture content file* and *Append to velocity file* options may be selected. If these options are selected, the name of previously computed moisture content and velocity files can be specified in the FEMWATER super file. The file can be edited using a text editor. The super file format is described in the FEMWATER reference manual. FEMWATER opens these files and appends the new moisture content and velocity values to the files after the designated hot start time.

Initial Condition File Format

For both the cold and hot start options, dataset files can be used to specify the initial conditions. These files can be saved in either ASCII or binary. The format of the files can be specified in the *Initial condition file format* section. All initial condition files should be either ASCII or binary, i.e., the types cannot be mixed for a given simulation. If the **Generate IC** button is used to create the pressure head file, the *ASCII* option should be selected.

Flow Files

A third type of initial condition is required when a transport only simulation is being performed. A transport only simulation utilizes a previously computed flow solution (steady state or transient) to define the three-dimensional flow field required to properly model the contaminant migration. The flow solution consists of a pressure head file.

The flow solution for a transport only simulation is used in combination with either a cold start or a hot start. With a cold start, a set of initial concentration values is provided for concentration in addition to the steady state or transient flow solution. With a hot start, a transient concentration solution and a hot start time is provided in addition to the flow solution.

When a *transport only* option is selected, the name of the pressure head file from the flow solution is entered at the bottom of the *Initial Conditions* dialog. The *Flow file format* options in the *FEMWATER Initial Conditions* dialog are used to specify whether these files are ASCII or binary, and whether they are steady state or transient.

Saving a FEMWATER Simulation

Once a FEMWATER simulation has been set up and checked for errors, the final step before running the model is to save the simulation. FEMWATER simulations are saved using the **Save** and **Save As** commands in the *File* menu.

Selecting the **Save** command saves the GMS project including the model simulation. By default the model simulation will be saved to the same location as the GMS project. However, in the *Save* dialog the path for the model simulation can be specified.

A FEMWATER simulation is actually saved to a set of input files. The FEMWATER super file is a special type of file which is used to organize the set of files used in a simulation. The names of all of the input and output files associated with a simulation are saved in the super file. When FEMWATER is launched, the name of the super file is automatically passed to the FEMWATER executable.

When a FEMWATER simulation is saved, the names of the other FEMWATER input files are automatically patterned after the name of the super file. For example, if the super file is named `sampmod.fws`, the other files are named `sampmod.geo`, `sampmod.3bc`, etc.



Geometry File Options

When a FEMWATER simulation is saved using the **Save** or **Save As** command, all data associated with the simulation is saved to disk, including both the mesh geometry and the boundary conditions. For large FEMWATER models, the mesh file can take up a substantial amount of disk space and take a long time to save. During a model exercise, it is often the case that multiple versions of the simulation are saved to disk where the only change from one simulation to the next is changes in the analysis options or boundary conditions. In such cases, both time and disk space can be saved by re-using the same geometry file from one run to the next. This can be accomplished by first saving a copy of the FEMWATER simulation to disk and then selecting the **Geometry File** command in the *FEMWATER* menu. This command brings up the *Geometry File* dialog. If the *Use existing geometry file*

option is selected, the browse  button can be used to identify the previously saved geometry file. Once this option is selected, each time GMS saves the FEMWATER super file, it does not re-save the geometry file. Rather, it saves the path to the specified geometry file.

6.2.2. FEMWATER Post-Processing

FEMWATER Display Options

The properties of all FEMWATER boundary conditions that GMS displays on the screen can be controlled through the FEMWATER tab of the *Display Options* dialog. This dialog is opened by right-clicking on the  3D Mesh Data entry in the [Project Explorer](#), selecting the **Display Options** command, and then selecting the *FEMWATER* tab. This tab is only visible when there is a FEMWATER simulation. It can also be accessed from the *Display* menu, the *FEMWATER* menu, or the **Display Options**  macro.

The following table describes the display options available for the FEMWATER model.

Display Option	Description
Well	Controls the display of well boundary conditions. The symbol, symbol size, and symbol color can be adjusted using the button to the left of the display toggle.
Well (super pump node)	Controls the display of well super pump nodes boundary conditions. The fill color can be adjusted using the button to the left of the display toggle.
Well conc.	Controls the display of well concentration boundary conditions. The symbol, symbol size, and symbol color can be adjusted using the button to the left of the display toggle.
Variable	Controls the display of variable boundary conditions. The symbol, symbol size, and symbol color can be adjusted using the button to the left of the display toggle.
Variable conc.	Controls the display of variable concentration boundary conditions. The symbol, symbol size, and symbol color can be adjusted using the button to the left of the display toggle.
Head	Controls the display of head boundary conditions. The symbol, symbol size, and symbol color can be adjusted using the button to the left of the display toggle.
Head conc.	Controls the display of head concentration boundary conditions. The symbol, symbol size, and symbol color can be adjusted using the button to the left of the display toggle.
Flux	Controls the display of flux boundary conditions. The symbol, symbol size, and symbol color can be adjusted using the button to the left of the display toggle.
Flux conc.	Controls the display of flux concentration boundary conditions. The symbol, symbol size, and symbol color can be adjusted using the button to the left of the display toggle.
Grad. flux.	Controls the display of gradient flux boundary conditions. The symbol, symbol size, and symbol color can be adjusted using the button to the left of the display toggle.
Grad. flux. conc.	Controls the display of gradient flux concentration boundary conditions. The symbol, symbol size, and symbol color can be adjusted using the button to the left of the display toggle.
BC values	Controls the display of boundary condition values. The font, font size, and font color can be adjusted using the button to the left of the display toggle.
Display symbol legend	Controls the display of a legend containing the symbols for the boundary conditions used in the FEMWATER simulation.
Check All	By clicking this button, all of the display options are turned on.
Check None	By clicking this button, all of the display options are turned off.

FEMWATER Post-Processing Viewing Options

Part of the output from FEMWATER is a set of files representing velocity, moisture content, pressure head, and concentration. These files are written in the standard GMS dataset file format and can be imported directly to GMS using the **Read Solution** command in the *FEMWATER* menu.

Once the FEMWATER solution datasets have been imported to GMS, the standard GMS visualization tools can be used to generate [vector](#) plots, [cross sections](#), [isosurfaces](#), and [animations](#).

One of the output options for FEMWATER is a flux file containing flow budget data for boundary nodes. Once this file is imported, FEMWATER fluxes for selected nodes can be viewed.

Particle Tracking

Particle tracking can be done with a FEMWATER solution, similar to using MODPATH to do particle tracking with a MODFLOW solution. For more information:

- [FEMWATER Particle Sets](#)

Flow / Flux

Computed flows can be automatically summed and displayed for FEMWATER simulations. To enable this option, the Save flux file option must be selected in the *FEMWATER Output Control* dialog prior to saving the FEMWATER model. When this option is selected, FEMWATER saves a lumped nodal flow dataset file as part of the FEMWATER solution. This file is automatically read into GMS as part of the FEMWATER solution.

Once a FEMWATER flux file has been read into memory as part of a FEMWATER solution, the computed flux through a set of nodes can be displayed simply by selecting the nodes. The flow budget (in, out, net) for the selected nodes is displayed in the **Status Bar** at the

bottom of the GMS window. The flow budget is only displayed if the active solution is a FEMWATER solution.

It should be noted that lumped nodal fluxes are only non-zero for boundary nodes where a boundary condition has been assigned.

FEMWATER Particle Sets

Particle tracking can be done with a FEMWATER solution, similar to using [MODPATH](#) to do particle tracking with a [MODFLOW](#) solution. Particle starting locations can be automatically generated at wells, or at element or element face centroids by using the the commands in the *Particle Tracking* menu. Once the starting locations are created, the pathlines are automatically computed. Particles are grouped into particle sets, just like with MODPATH.

Restrictions

In order to compute the pathlines, the FEMWATER solution must contain nodal velocity, and nodal moisture content datasets. Tell FEMWATER to create these datasets using the *Output Control* dialog. Also, the effective porosity ratio for all materials must be non-zero.

Particle tracking is steady state only. That is, the particles are only influenced by the active time step.

Particles are currently not tracked correctly through hexahedron elements. If refining the hex elements to create wedges, the particles will be tracked correctly.

Display Options

A set of display options associated with FEMWATER particle tracking is provided in GMS. These options are accessed through the **Display Options** command in the *Particle Tracking* menu. This command is only available if a FEMWATER simulation exists. This command brings up the *Particles* tab of the *3D Mesh Display Options* dialog. The following table describes the display options available for the particle tracking.

Display Option	Description
Starting locations	The starting locations for the particles can be turned on and off. The symbol style, color and size can also be adjusted.
Starting location indices	The starting locations indices for the particles can be turned on and off. The font style, color and size can also be adjusted.
Ending locations	The ending locations for the particles can be turned on and off. The symbol style, color and size can also be adjusted.
Pathlines	The pathlines can be toggled on and off, and the pathline style and color can be adjusted. The pathline color can be set to the default color, or the color corresponding to the starting or ending zone codes of the pathlines.
Direction arrows	Direction arrows can be displayed along the pathlines. The size of the arrow heads can be set by specifying the length in pixels. The arrows are displayed along the pathline at an interval corresponding to the length specified.
Auto-update	The auto-update can be turned off and on, and controls the automatic updating of the particles.

6.3. MODAEM

MODAEM

MODAEM is an analytic element model developed by Vic Kelson of Wittman Hydro Planning Associates (WHPA) of Bloomington, Indiana. The key feature of analytic element models is that they do not require the discretization of the interior of the model domain into cells and elements as is the case with finite difference and finite element models. Rather, the model is defined by “analytic elements” representing line sources and sinks such as rivers and drains or specified head and specified flow boundaries. Wells are also represented as points, and recharge and aquifer properties can be defined on polygons. MODAEM then formulates a set of equations based on these entities and the equations can be solved for any location in the horizontal plane.

MODAEM is perfectly suited for the conceptual model approach used by GMS since the input data to MODAEM is consistent with the GIS feature objects (points, arcs, and polygons) used to define a GMS conceptual model. In other words, once a MODAEM conceptual model is defined, the model can be immediately executed. There is no need to build a grid or mesh. A background grid is utilized for displaying the MODAEM results using contour lines. However, the background grid is purely for visualization purposes and has nothing to do with the accuracy of the model. MODAEM also supports particle tracking/streamlines.

One of the caveats of the analytical element approach is that a simplified representation of the aquifer must be used. The aquifer properties (K, porosity, bottom elevation, aquifer thickness) can be assigned to polygons, but they are assumed to be constant within each polygon. Currently MODAEM supports steady, confined and unconfined two-dimensional groundwater flow, although streamlines are computed in three dimensions.

Linking MODAEM and MODFLOW

GMS also includes a feature to link MODAEM models with MODFLOW models. The main application of this linkage is for defining boundary conditions for a local scale model. A regional model can be built with MODAEM and then linked to a local scale MODFLOW

model. This is accomplished as follows:

1. Build and calibrate the regional scale model using [MODFLOW](#).
2. Build a [conceptual model](#) for the local scale MODFLOW model. When setting up the coverage properties for the source/sink coverages, be sure to toggle on the *MODAEM Head* and *Observed Flow* options in the *Source/Sink/BC's* list. If there are more than one MODAEM model in the project, it will be necessary to select which model should be linked to the MODFLOW model using the *MODAEM models* combo box at the bottom of the *Coverage Setup* dialog.
3. Mark the boundaries (or at least the upstream and downstream boundaries) of the MODFLOW conceptual model as *MODAEM Head boundaries*.

At this point, whenever the **Map → MODFLOW** command is executed, GMS will automatically launch the MODAEM model and calculate a head value for each grid cell coinciding with the MODAEM head boundary. Furthermore, a flow value is computed for the boundary using MODAEM and assigned to the MODFLOW boundary as an observed head. This makes it possible to monitor the flow budget across the boundary to ensure that the changes made to the local scale model (insertion of remedial wells, etc.) do not violate the flow conditions inherited from the regional scale model.

MODAEM Output File

When MODAEM is executed, it generates an HTML formatted text output file. If the execution is successfully completed, an icon  will appear under the corresponding MODAEM conceptual model in the Project Explorer representing the output file. Double-clicking on this icon loads the output file into the default web browser.

MODAEM Links

- [MODAEM License Agreement](#)
- [MODAEM Display Options](#)

MODAEM License Agreement

GNU GENERAL PUBLIC LICENSE

Version 2, June 1991

Copyright (C) 1989, 1991 Free Software Foundation, Inc.

59 Temple Place, Suite 330, Boston, MA 02111-1307 USA

Everyone is permitted to copy and distribute verbatim copies of this license document, but changing it is not allowed.

Preamble

The licenses for most software are designed to take away your freedom to share and change it. By contrast, the GNU General Public License is intended to guarantee your freedom to share and change free software--to make sure the software is free for all its users. This General Public License applies to most of the Free Software Foundation's software and to any other program whose authors commit to using it. (Some other Free Software Foundation software is covered by the GNU Library General Public License instead.) You can apply it to your programs, too.

When we speak of free software, we are referring to freedom, not price. Our General Public Licenses are designed to make sure that you have the freedom to distribute copies of free software (and charge for this service if you wish), that you receive source code or can get it if you want it, that you can change the software or use pieces of it in new free programs; and that you know you can do these things.

To protect your rights, we need to make restrictions that forbid anyone to deny you these rights or to ask you to surrender the rights. These restrictions translate to certain responsibilities for you if you distribute copies of the software, or if you modify it.

For example, if you distribute copies of such a program, whether gratis or for a fee, you must give the recipients all the rights that you have. You must make sure that they, too, receive or can get the source code. And you must show them these terms so they know

their rights.

We protect your rights with two steps:

- (1) copyright the software, and
- (2) offer you this license which gives you legal permission to copy, distribute and/or modify the software.

Also, for each author's protection and ours, we want to make certain that everyone understands that there is no warranty for this free software. If the software is modified by someone else and passed on, we want its recipients to know that what they have is not the original, so that any problems introduced by others will not reflect on the original authors' reputations.

Finally, any free program is threatened constantly by software patents. We wish to avoid the danger that redistributors of a free program will individually obtain patent licenses, in effect making the program proprietary. To prevent this, we have made it clear that any patent must be licensed for everyone's free use or not licensed at all.

The precise terms and conditions for copying, distribution and modification follow.

GNU GENERAL PUBLIC LICENSE

TERMS AND CONDITIONS FOR COPYING, DISTRIBUTION AND MODIFICATION

0. This License applies to any program or other work which contains a notice placed by the copyright holder saying it may be distributed

under the terms of this General Public License. The "Program", below, refers to any such program or work, and a "work based on the Program" means either the Program or any derivative work under copyright law: that is to say, a work containing the Program or a portion of it, either verbatim or with modifications and/or translated into another

language. (Hereinafter, translation is included without limitation in the term "modification".)

Each licensee is addressed as "you".

Activities other than copying, distribution and modification are not covered by this License; they are outside its scope. The act of running the Program is not restricted, and the output from the Program is covered only if its contents constitute a work based on the Program

(independent of having been made by running the Program). Whether that is true depends on what the Program does.

1. You may copy and distribute verbatim copies of the Program's source code as you receive it, in any medium, provided that you conspicuously and appropriately publish on each copy an appropriate copyright notice and disclaimer of warranty; keep intact all the notices that refer to this License and to the absence of any warranty; and give any other recipients of the Program a copy of this License along with the Program.

You may charge a fee for the physical act of transferring a copy, and you may at your option offer warranty protection in exchange for a fee.

2. You may modify your copy or copies of the Program or any portion of it, thus forming a work based on the Program, and copy and distribute such modifications or work under the terms of Section 1 above, provided that you also meet all of these conditions:

a) You must cause the modified files to carry prominent notices stating that you changed the files and the date of any change.

b) You must cause any work that you distribute or publish, that in whole or in part contains or is derived from the Program or any part thereof, to be licensed as a whole at no charge to all third parties under the terms of this License.

c) If the modified program normally reads commands interactively when run, you must cause it, when started running for such interactive use in the most ordinary way, to print or display an announcement including an appropriate copyright notice and a notice that there is no warranty (or else, saying that you provide a warranty) and that users may redistribute the program under these conditions, and telling the user how to view a copy of this License. (Exception: if the Program itself is interactive but does not normally print such an announcement, your work based on the Program is not required to print an announcement.)

These requirements apply to the modified work as a whole. If identifiable sections of that work are not derived from the Program, and can be reasonably considered independent and separate works in themselves, then this License, and its terms, do not apply to those sections when you distribute them as separate works. But when you distribute the same sections as part of a whole which is a work based on the Program, the distribution of the whole must be on the terms of this License, whose permissions for other licensees extend

to the entire whole, and thus to each and every part regardless of who wrote it.

Thus, it is not the intent of this section to claim rights or contest your rights to work written entirely by you; rather, the intent is to exercise the right to control the distribution of derivative or collective works based on the Program.

In addition, mere aggregation of another work not based on the Program with the Program (or with a work based on the Program) on a volume of a storage or distribution medium does not bring the other work under the scope of this License.

3. You may copy and distribute the Program (or a work based on it, under Section 2) in object code or executable form under the terms of Sections 1 and 2 above provided that you also do one of the following:

a) Accompany it with the complete corresponding machine-readable source code, which must be distributed under the terms of Sections 1 and 2 above on a medium customarily used for software interchange; or,

b) Accompany it with a written offer, valid for at least three years, to give any third party, for a charge no more than your cost of physically performing source distribution, a complete machine-readable copy of the corresponding source code, to be distributed under the terms of Sections 1 and 2 above on a medium customarily used for software interchange; or,

c) Accompany it with the information you received as to the offer to distribute corresponding source code. (This alternative is allowed only for noncommercial distribution and only if you received the program in object code or executable form with such an offer, in accord with Subsection b above.) The source code for a work means the preferred form of the work for making modifications to it. For an executable work, complete source code means all the source code for all modules it contains, plus any associated interface definition files, plus the scripts used to control compilation and installation of the executable. However, as a special exception, the source code distributed need not include anything that is normally distributed (in either source or binary form) with the major components (compiler, kernel, and so on) of the operating system on which the executable runs, unless that component itself accompanies the executable.

If distribution of executable or object code is made by offering access to copy from a designated place, then offering equivalent access to copy the source code from the same

place counts as distribution of the source code, even though third parties are not compelled to copy the source along with the object code.

4. You may not copy, modify, sublicense, or distribute the Program except as expressly provided under this License. Any attempt otherwise to copy, modify, sublicense or distribute the Program is void, and will automatically terminate your rights under this License.

However, parties who have received copies, or rights, from you under this License will not have their licenses terminated so long as such parties remain in full compliance.

5. You are not required to accept this License, since you have not signed it. However, nothing else grants you permission to modify or distribute the Program or its derivative works. These actions are prohibited by law if you do not accept this License. Therefore, by modifying or distributing the Program (or any work based on the Program), you indicate your acceptance of this License to do so, and all its terms and conditions for copying, distributing or modifying the Program or works based on it.

6. Each time you redistribute the Program (or any work based on the Program), the recipient automatically receives a license from the original licensor to copy, distribute or modify the Program subject to these terms and conditions. You may not impose any further restrictions on the recipients' exercise of the rights granted herein.

You are not responsible for enforcing compliance by third parties to this License.

7. If, as a consequence of a court judgment or allegation of patent infringement or for any other reason (not limited to patent issues), conditions are imposed on you (whether by court order, agreement or otherwise) that contradict the conditions of this License, they do not excuse you from the conditions of this License. If you cannot distribute so as to satisfy simultaneously your obligations under this License and any other pertinent obligations, then as a consequence you may not distribute the Program at all. For example, if a patent license would not permit royalty-free redistribution of the Program by all those who receive copies directly or indirectly through you, then the only way you could satisfy both it and this License would be to refrain entirely from distribution of the Program.

If any portion of this section is held invalid or unenforceable under any particular circumstance, the balance of the section is intended to apply and the section as a whole is intended to apply in other circumstances.

It is not the purpose of this section to induce you to infringe any patents or other property right claims or to contest validity of any such claims; this section has the sole purpose of protecting the integrity of the free software distribution system, which is implemented by public license practices. Many people have made generous contributions to the wide range of software distributed through that system in reliance on consistent application of that system; it is up to the author/donor to decide if he or she is willing to distribute software through any other system and a licensee cannot impose that choice.

This section is intended to make thoroughly clear what is believed to be a consequence of the rest of this License.

8. If the distribution and/or use of the Program is restricted in certain countries either by patents or by copyrighted interfaces, the original copyright holder who places the Program under this License may add an explicit geographical distribution limitation excluding those countries, so that distribution is permitted only in or among countries not thus excluded. In such case, this License incorporates the limitation as if written in the body of this License.

9. The Free Software Foundation may publish revised and/or new versions of the General Public License from time to time. Such new versions will be similar in spirit to the present version, but may differ in detail to address new problems or concerns.

Each version is given a distinguishing version number. If the Program specifies a version number of this License which applies to it and "any later version", you have the option of following the terms and conditions either of that version or of any later version published by the Free Software Foundation. If the Program does not specify a version number of this License, you may choose any version ever published by the Free Software Foundation.

10. If you wish to incorporate parts of the Program into other free programs whose distribution conditions are different, write to the author to ask for permission. For software which is copyrighted by the Free Software Foundation, write to the Free Software Foundation; we sometimes make exceptions for this. Our decision will be guided by the two goals of preserving the free status of all derivatives of our free software and of promoting the sharing and reuse of software generally.

NO WARRANTY

11. BECAUSE THE PROGRAM IS LICENSED FREE OF CHARGE, THERE IS NO

WARRANTY FOR THE PROGRAM, TO THE EXTENT PERMITTED BY APPLICABLE LAW. EXCEPT WHEN OTHERWISE STATED IN WRITING THE COPYRIGHT HOLDERS AND/OR OTHER PARTIES PROVIDE THE PROGRAM "AS IS" WITHOUT WARRANTY OF ANY KIND, EITHER EXPRESSED OR IMPLIED, INCLUDING, BUT NOT LIMITED TO, THE IMPLIED WARRANTIES OF MERCHANTABILITY AND FITNESS FOR A PARTICULAR PURPOSE. THE ENTIRE RISK AS TO THE QUALITY AND PERFORMANCE OF THE PROGRAM IS WITH YOU. SHOULD THE PROGRAM PROVE DEFECTIVE, YOU ASSUME THE COST OF ALL NECESSARY SERVICING, REPAIR OR CORRECTION.

12. IN NO EVENT UNLESS REQUIRED BY APPLICABLE LAW OR AGREED TO IN WRITING WILL ANY COPYRIGHT HOLDER, OR ANY OTHER PARTY WHO MAY MODIFY AND/OR REDISTRIBUTE THE PROGRAM AS PERMITTED ABOVE, BE LIABLE TO YOU FOR DAMAGES, INCLUDING ANY GENERAL, SPECIAL, INCIDENTAL OR CONSEQUENTIAL DAMAGES ARISING OUT OF THE USE OR INABILITY TO USE THE PROGRAM (INCLUDING BUT NOT LIMITED TO LOSS OF DATA OR DATA BEING RENDERED INACCURATE OR LOSSES SUSTAINED BY YOU OR THIRD PARTIES OR A FAILURE OF THE PROGRAM TO OPERATE WITH ANY OTHER PROGRAMS), EVEN IF SUCH HOLDER OR OTHER PARTY HAS BEEN ADVISED OF THE POSSIBILITY OF SUCH DAMAGES. END OF TERMS AND CONDITIONS

How to Apply These Terms to Your New Programs

If you develop a new program, and you want it to be of the greatest possible use to the public, the best way to achieve this is to make it free software which everyone can redistribute and change under these terms.

To do so, attach the following notices to the program. It is safest to attach them to the start of each source file to most effectively convey the exclusion of warranty; and each file should have at least the "copyright" line and a pointer to where the full notice is found.

```
}}--> This is free software, and you are welcome to redistribute it under certain conditions;  
type `show c' for details.
```

The hypothetical commands `show w' and `show c' should show the appropriate parts of the General Public License. Of course, the commands you use may be called something

other than `show w' and `show c'; they could even be mouse-clicks or menu items-- whatever suits your program.

You should also get your employer (if you work as a programmer) or your school, if any, to sign a "copyright disclaimer" for the program, if necessary. Here is a sample; alter the names:



Yoyodyne, Inc., hereby disclaims all copyright interest in the program `Gnomovision' (which makes passes at compilers) written by James Hacker. , 1 April 1989 Ty Coon, President of Vice

This General Public License does not permit incorporating your program into proprietary programs. If your program is a subroutine library, you may consider it more useful to permit linking proprietary applications with the library. If this is what you want to do, use the GNU Library General Public License instead of this License.

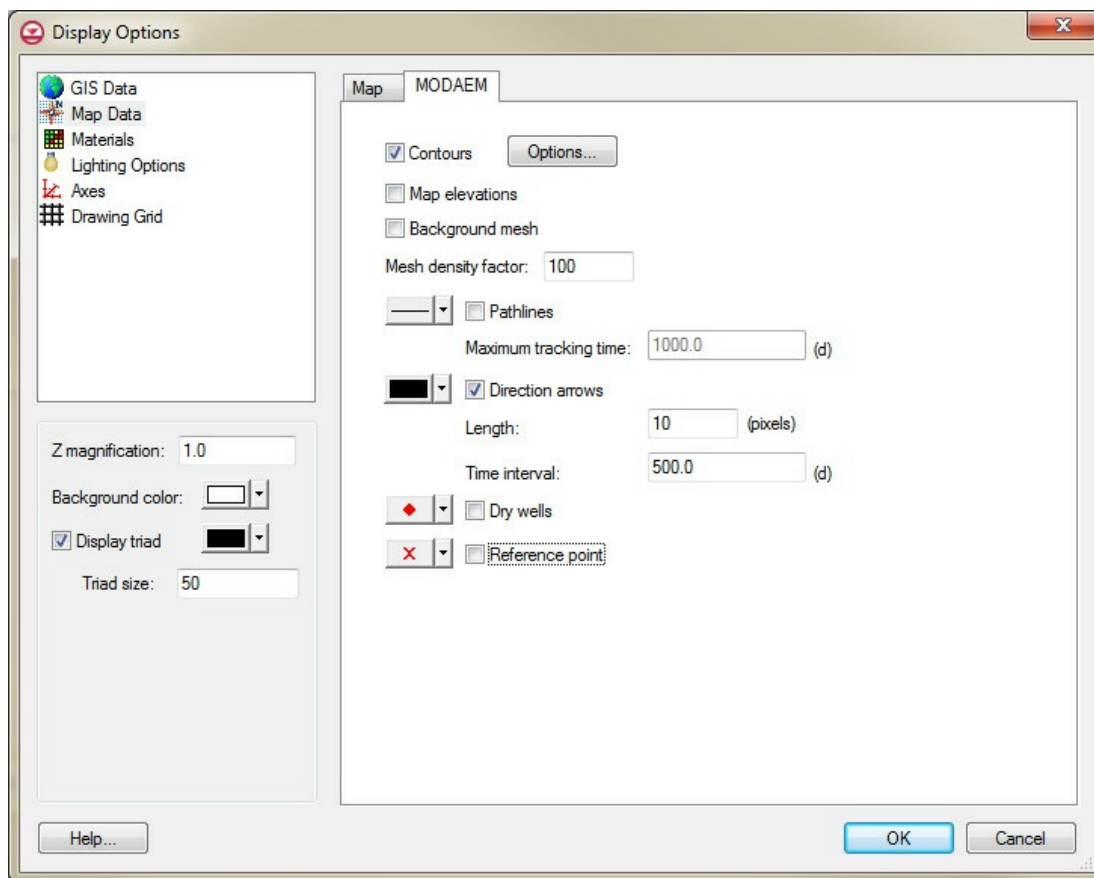
MODAEM Display Options



The Display Options dialog showing the MODAEM tab.

The properties of all MODAEM properties that GMS displays on the screen can be controlled through the *MODAEM* tab of the *Display Options* dialog. This dialog is opened by right-clicking on the  Map Data entry in the [Project Explorer](#), selecting the **Display Options** command, and then selecting the *MODAEM* tab. This tab is only visible when there is a MODAEM simulation. It can also be accessed from the *Display* menu, the *MODAEM* menu, or the **Display Options**  macro. The following table describes the display options available for the MODAEM model.

Display Option	Description
Contours	Whenever MODAEM is executed, the head values are computed at the corners of a background grid. These head values can then be contoured. Most of the objects supported by GMS can be contoured by turning on the Contour in the <i>Display Options</i> dialog. When an object is contoured, the values associated with the active dataset for the object are used to generate the contours.
Map elevations	If the <i>Map Elevations</i> option is selected in the <i>MODAEM Display Options</i> dialog, the head values are mapped to elevations (z values) of the background grid and the contours are displayed on the resulting warped grid in oblique view. This makes it possible to see a 3D view of the computed water table surface.
Background mesh	Controls the displays of a background grid. The density of the background grid can be adjusted using the Mesh density factor edit field. The background grid is always adjusted to fit the area defined by the boundary polygon or the GMS graphics window. If the user zooms in to look at a local area of the model and select the F5 button, the background grid is rebuilt to fit the current viewing area. In this manner, one can view the solution at any desired level of detail.
Pathlines	<p>The pathlines can be toggled on and off, and the pathline style and color can be adjusted. The pathline color can be set to the default color, or the color corresponding to the starting or ending zone codes of the pathlines.</p> <p>If the <i>Pathlines</i> option is turned on for one or more MODAEM wells, a set of pathlines are automatically computed by MODAEM and displayed when the solution is updated. For wells, pathlines are always computed backwards in time. The display options associated with the pathlines (max tracking time, direction arrows, etc.) can be controlled using the <i>MODAEM Display Options</i> dialog.</p> <p>Particles may also be created at user-specified points in the aquifer, including a starting elevation. GMS will pass these points to MODAEM for forward tracing. Currently, GMS does not provide a way to trace these particles backwards in time.</p>
Direction arrows	Direction arrows can be displayed along the pathlines. The size of the arrow heads can be set by specifying the Length in pixels. The arrows are displayed along the pathline at an interval corresponding to the Length specified.
Dry wells	Controls the display of wells that have gone dry during the MODAEM simulation run. They symbol, symbol size, and symbol color can be adjusted by clicking on the button to the left of the toggle.
Reference point	Controls the display of reference points. They symbol, symbol size, and symbol color can be adjusted by clicking on the button to the left of the toggle.

MODAEM Commands

When the MODAEM model is active, the *MODAEM* menu becomes available. The menu has the following commands:

Global Options...

Opens the *MODAEM Global Options* dialog.

Display Options...

Opens the *MODAEM* tab of the *Display Options* dialog.

Solve

This command will execute the MODAEM model.

Pathlines → Arcs

This command will create a new coverage.

Contours → Arcs

This command will create a new coverage.

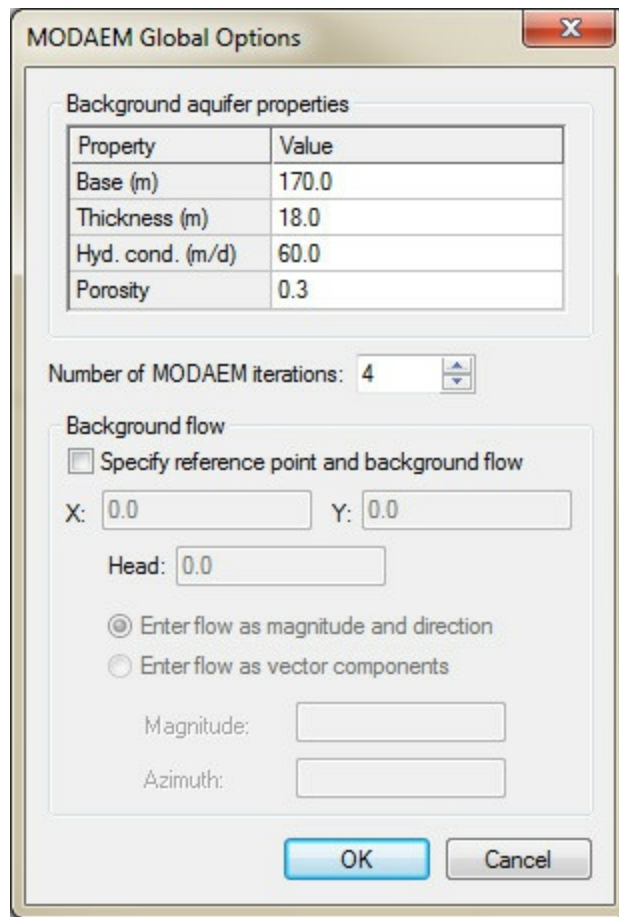

The MODAEM Global Options dialog.

Related Topics

- [MODAEM](#)

6.4. MODFLOW

MODFLOW

GMS includes a comprehensive graphical interface to the groundwater model MODFLOW. MODFLOW (originally called the Modular Three-Dimensional Finite-Difference Ground-Water Flow Model) is a 3D, cell-centered, finite difference, saturated flow model developed by the United States Geological Survey (McDonald & Harbaugh, 1988). MODFLOW can perform both steady state and transient analyses and has a wide variety of boundary conditions and input options. In GMS, MODFLOW can work with the 3D Grid module and 3D UGrid module.

GMS supports MODFLOW as a pre- and post-processor. The input data for MODFLOW are generated by GMS and saved to a set of files. These files are read by MODFLOW when MODFLOW is launched from the [MODFLOW menu](#). The output from MODFLOW is then imported to GMS for post-processing.

A special version of MODFLOW is distributed with GMS. This version of MODFLOW is the same as the version distributed by the USGS except for a few minor changes primarily related to file input including reading input data from HDF5 files. These changes are clearly marked in the code. For more information see [MODFLOW with HDF5](#).

To learn more about using MODFLOW in GMS, please refer to the available [tutorials](#).

More information about MODFLOW is available from the [USGS](#).

The MODFLOW model is included with all [editions](#) of GMS, including the community version.

MODFLOW Versions

GMS supports all standard MODFLOW versions. For a list of input files and packages supported in each version see [here](#).

- [MODFLOW-88](#) (import only)
- [MODFLOW-96](#) (import only)
- [MODFLOW-2000](#)

- [MODFLOW-2005](#)
- [MODFLOW-NWT](#)
- [MODFLOW-LGR](#)
- [MODFLOW-USG](#)

Pre-Processing

- [MODFLOW Menu Overview](#)
- [Importing MODFLOW Files](#)
- [Building a MODFLOW Model](#)
- [Saving a MODFLOW Simulation](#)
- [Parameters](#)
- [Stochastic Modeling with MODFLOW](#)
- [Interpolate to MODFLOW Layers](#)
- [Packages Supported in GMS](#)
- [Unsupported MODFLOW Features](#)

Post-Processing

- [MODFLOW Display Options](#)
- [MODFLOW Post-Processing Viewing Options](#)
- [Reading a MODFLOW Simulation](#)

MODFLOW Documentation

- [MODFLOW website](#)
- [Online guide to MODFLOW-2000](#)

- [Online guide to MODFLOW-2005](#)
- [Online guide to MODFLOW-LGR](#)
- [Online guide to MODFLOW-NWT](#)
- [MODFLOW 88I](#)
- [MODFLOW 88II](#)
- [MODFLOW 96I](#)
- [MODFLOW 96II](#)
- [MF2K Calibration](#)
- [MF2K Flow Process](#)
- [MF2K HUF](#)
- [MF2K LMG](#)
- [MF2K LMT](#)
- [MF2K Observation, Sensitivity, and Parameter-Estimation Processes](#)
- [MF2005 Flow Process](#)
- [MF NWT](#)
- [MF USG](#)
- [MODFLOW-USG 1.3 Manual in doc folder](#)

MODFLOW-2005

GMS supports MODFLOW 2005 since GMS version 8.0.

Choosing MODFLOW-2000 or MODFLOW-2005

Choosing to use MODFLOW-2000 or MODFLOW-2005 is done in the [MODFLOW Global/Basic Package dialog](#). Switch from one to the other at any time.

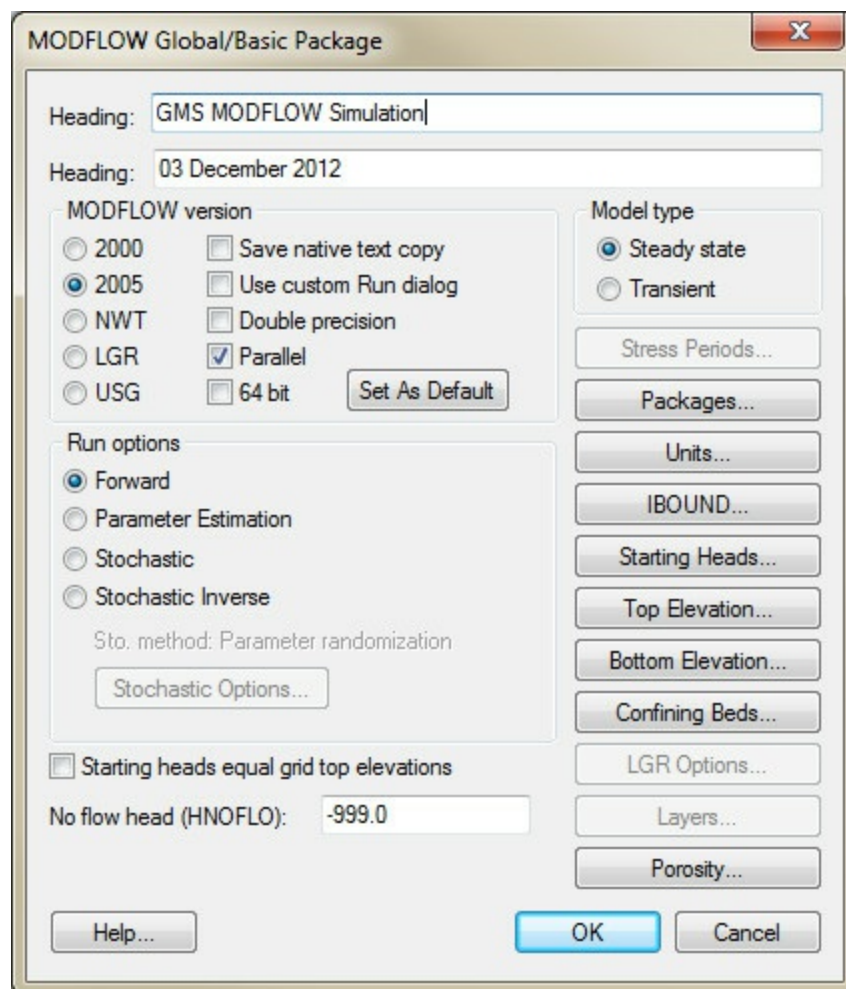

MODFLOW Global/Basic Package dialog.

Changes in MODFLOW-2005

The following list shows changes in MODFLOW-2005 from MODFLOW-2000.

1. **SOR1 Solver**

MODFLOW-2005 no longer supports the SOR1 Solver.

2. **PCG2 Solver**

MODFLOW-2005 replaces the DAMP variable with DAMPPCG and DAMPPCGT variables ([see here](#)). These two new variables allow different damping factors to be applied separately to steady-state and transient stress periods.

3. **UZF Package**

MODFLOW-2005 added support for the [Unsaturated Zone Flow \(UZF\)](#) package.

4. **LPF package**

MODFLOW-2005 provides more options for the LPF Package. Pictures below show the LPF package options supported in MODFLOW-2000 vs MODFLOW-2005.

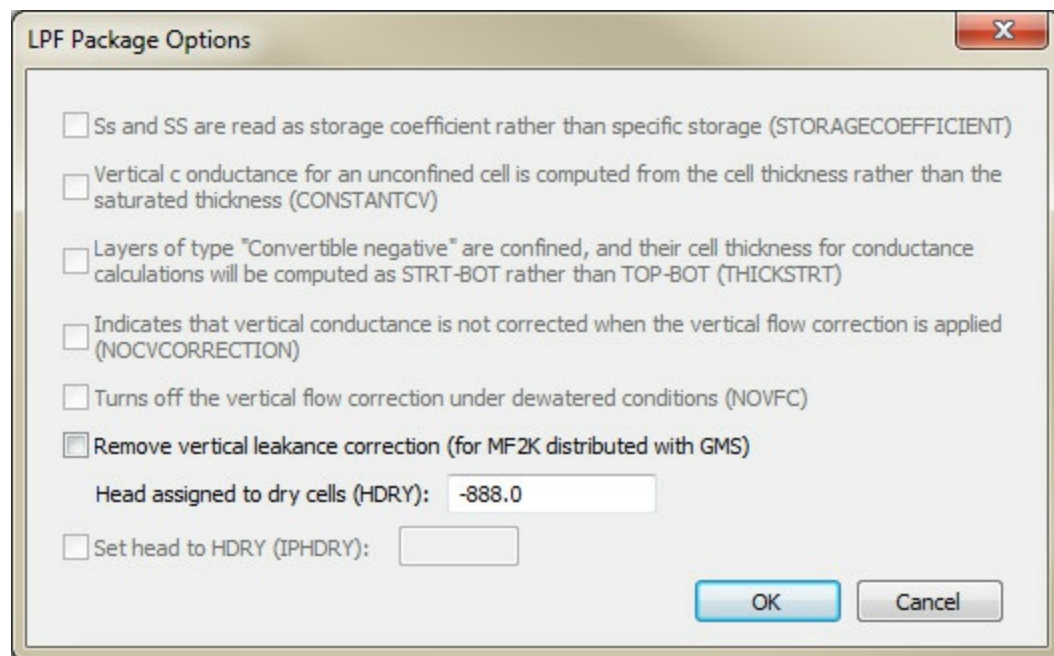

MODFLOW 2000 LPF Package Options.

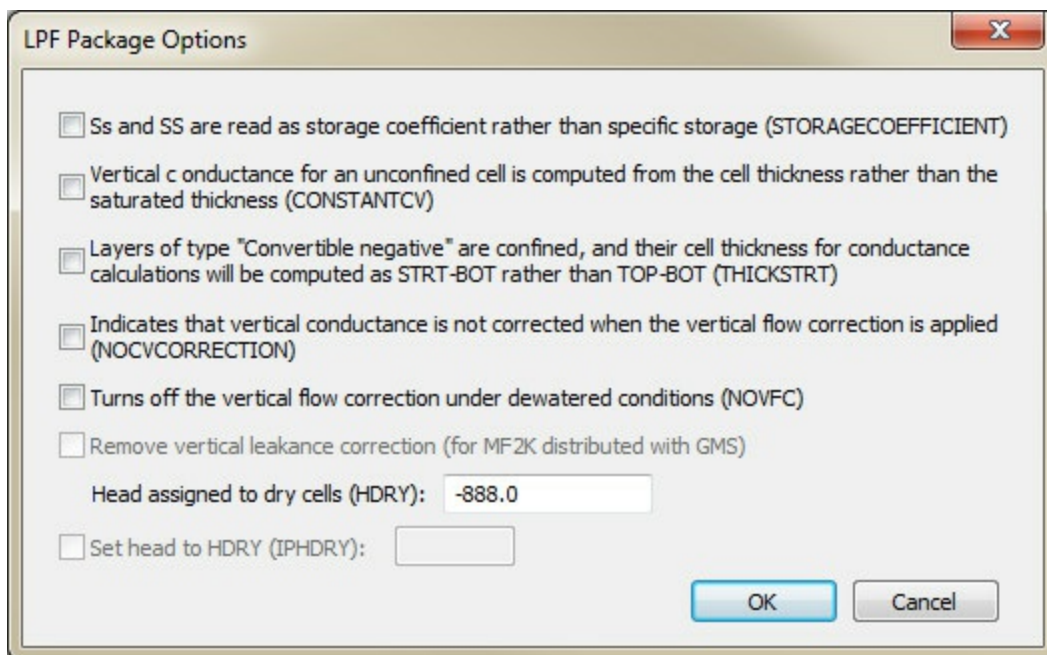

MODFLOW 2005 LPF Package Options.

5. PES and PEST

PES is not available in MODFLOW 2005. Automated calibration in GMS is handled using PEST.

MODFLOW 2005 Files

Below are tables of some of the available input and output files for MODFLOW 2005. Note: MODFLOW will produce the LMT and HFF files even if transport is turned off.

- For more information on these files see the [manual](#).

Required Input Files

Name	Description
MFN	MODFLOW Name File
GLO	Global Listing File
DIS	Discretization File
OC	Process Output Control Option File
BA6	Basic Package Global Options File

Solver Package File

Name	Description
DE4	Direct
GMG	Geometric Multi-Grid
PCG	Preconditioned Conjugate-Gradient
SIP	Strongly Implicit Procedure
SOR	Slice-Successive Overrelaxation

Input Flow Package Files

Name	Description
BCF	Evapotranspiration Segments
HUF	Evapotranspiration
LPF	Layer Property Flow
UPW	Unsaturated-Zone Flow

Optional Package Files

Name	Description
ASP	PEST Advanced Spatial Parameterization
CHD	Time-Variant Specified-Head
DRN	Drain
DRT	Drain Return
EVT	Evapotranspiration
ETS	Evapotranspiration Segments
GAG	Gage
GHB	General Head Boundary
HFB	Horizontal Flow Barrier
LAK	Lake
PARAM	PEST Parameter Variables
RCH	Recharge
RIV	River
SFR	Streamflow-Routing
STR	Stream-Routing
SUB	Subsidence
SWI	Seawater Intrusion
UZF	Unsaturated-Zone Flow
WEL	Process Well

Observation Input Files

Name	Description
OBS	Main Observation Process Input
DROB	Drain Observation
CHOB	Constant-Head Flow Observation Input

Output Files

Name	Description
MFS	MODFLOW Super File
MFW	GMS MODFLOW World File
MFR	GMS MODFLOW Result Index File
PRJ	Projection
CSV	Cell Summary Comma Separated Value Excel
HFF	Head and Flow File Link to MT3DMS
H5	Hierarchal Data Format (HDF5) Array & List Data
LMT	Link Modular Transport (MT3DMS)
M2P	MODFLOW Pest
PARAM	Parameter Information
P00	Error File

Output Results Files

Name	Description
CCF	Cell-to-Cell Aquifer Flow
CCF2	Cell-to-Cell Stream Reach Outflow
DRW	Drawdown
GLO	Global Listing
HED	Head Output
OUT	Output

Output Package Files

Name	Description
MNW	Multi-Node Well
MNW2	Multi-Node Well Version 2
MNWI	Multi-Node Well Information
SWIBUD	Seawater Intrusion Package Budget
SWIZETA	Seawater Intrusion Package Zeta Surface

Output Data Exchange Files

Name	Description
_W	Weighted Residuals
_WW	Weighted Equivalents & Weighted Observation
_WS	Weighted Residuals and Simulated Equivalents
_R	Unweighted Residuals
_OS	Observed Values and Simulated Equivalents
_B	Data Exchange File
_NM	Weighted Residuals and Probability Plotting

External Links

- [Online MODFLOW 2005 Manual](#)

MODFLOW-LGR

MODFLOW-LGR (Local Grid Refinement) is a modified version of MODFLOW-2005 that allows for using multiple grids with different refinement.

The MODFLOW-LGR model can be added to a [paid edition](#) of GMS.

Set Up

To use MODFLOW-LGR, the user must specify this as the version in the [MODFLOW Global Options dialog](#). If there are child grids and the user switches from MODFLOW-LGR to a different version, ***the child grids will be deleted***.

LGR Options

When MODFLOW-LGR is the specified version in the *MODFLOW Global Options* dialog, the **LGR Options** button becomes available. This opens the *LGR Options* dialog.

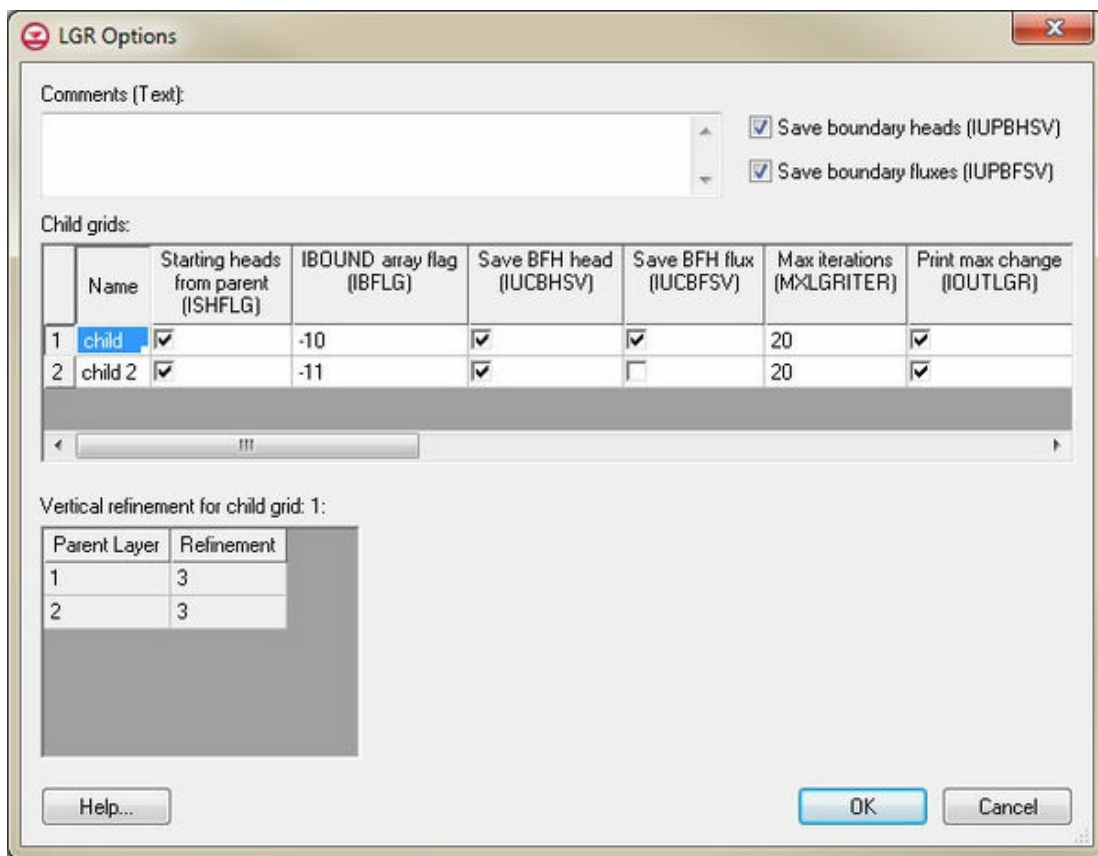

LGR Options dialog.

The items in the dialog correspond to what gets written in the LGR Control File. The child grids are listed in the upper spreadsheet. When a row is selected, the vertical refinement table lists the refinement by layer for the selected child grid. Child grids cannot be created or deleted here—that is done in the [Graphics Window](#) and the [Project Explorer](#). They can also not be moved or have their horizontal or vertical refinement edited. All other options are editable.

Parent and Child Grids

MODFLOW-LGR allows for the creation of more refined child grids in areas of particular interest. To create a child grid in GMS, you select a range of cells in the parent grid, right-click, and select the **Create Child Grid** menu command. This opens the *Create Child Grid* dialog.

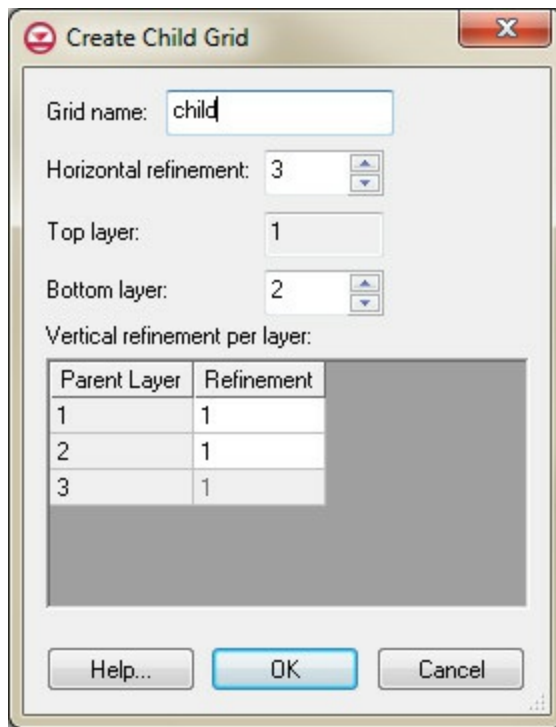

Create Child Grid dialog.

This dialog allows specifying the child *Grid name*, the *Horizontal refinement*, the *Bottom layer* in the parent grid, and the *Vertical refinement per layer*. The *Top layer* must always be 1, and both horizontal and vertical refinement values must be odd numbers. Child grids show up under the parent grid in the Project Explorer. Each child grid will have it's own MODFLOW model underneath it.

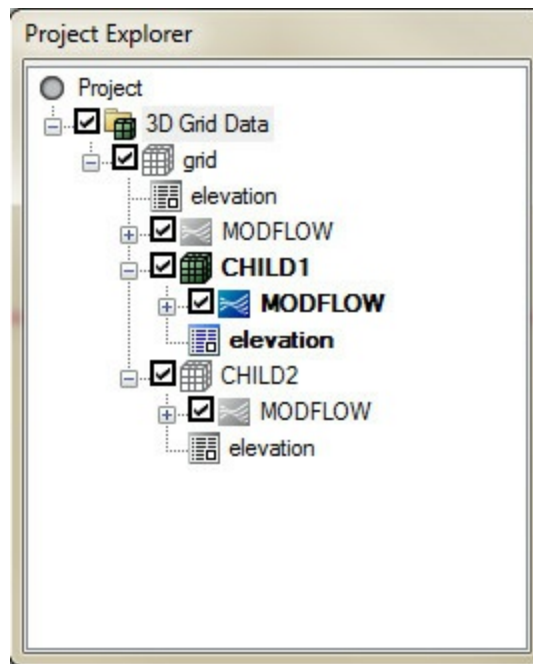

Child Grids in the Project Explorer.

Active Grid and MODFLOW

There is only one active grid and MODFLOW simulation at a time. The active grid and MODFLOW icons appear in color, the inactive icons appear in grey. To switch the active grid or MODFLOW simulation, simply click on it in the *Project Explorer*. The main menus for the grid and MODFLOW refer to the active grid and MODFLOW simulation, and the grid tools (cell selection etc) only act on the active grid. Many dialogs in the MODFLOW interface will append "- parent" or "- child" to the dialog title to remind the user what simulation the dialog is acting on.

Ortho mode

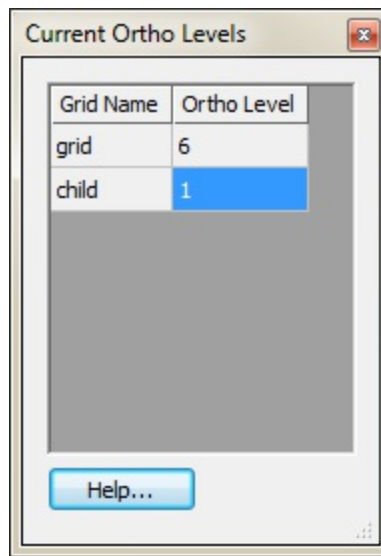

Current Ortho Levels dialog

When child grids exist and the display is in [ortho mode](#), the current grid level (row, column or layer) being viewed can be different for each grid. A setting in the [3D Grid Display Options](#) exists called *Synch ortho levels with all grids* which, if on, causes GMS to display the appropriate ortho level for all grids as the active grid level changes. If this option is off, only the level of the active grid will change. To see what ortho levels are currently being displayed the user can click on the *Multiple grids* toggle on the [Mini-Grid toolbar](#). This brings up the *Current Ortho Levels* dialog which is a modeless dialog that shows the current ortho levels being displayed on all grids. Being modeless, the dialog can be moved aside and the user can continue to interact with GMS.

Adjusting BCs Along the Boundary

As described in the LGR documentation, cells along the parent/child interface are truncated but the packages assume the full cell area. Thus adjustments should be made in these cells where DRN, EVT, GHB, RCH, or RIV packages are used. When creating a new child grid, GMS uses the equations on page 6 of the LGR documentation to copy the BCs to the child grid and adjust the conductance (or recharge or evapotranspiration) in these cells. Also, when doing [Map → MODFLOW](#) the areal BCs (recharge, ET) are adjusted in border cells, but list BCs (DRN, RIV etc) are not adjusted. It is best not to have list BCs in border cells.

Running Models Independently

By default the parent and child models are run coupled when MODFLOW is executed, but they can be run independently. To run the parent or a child model independently, right-click on the model in the Project Explorer and select the **Run MODFLOW Uncoupled On Just This Model** command.

BFH Package

The Boundary Flow and Head (BFH) Package is unique to MODFLOW-LGR and allows for the coupled heads and flows along the parent/child border to be saved and applied when running the parent or a child independently. Use of the package is a two step process. First the models must be run coupled to calculate and save the boundary heads and flows. Then the BFH package is turned on and pointed to the saved heads or flows and a model is run independently. Turning on the option to save the boundary heads/flows is done in the *LGR Options* dialog. The BFH package is turned on in the usual way, using the *Packages* dialog. The *BFH package* dialog simply let's the user point to the head or flow files created during a coupled run. The BFH Package is demonstrated in the MODFLOW-LGR tutorial.

Restrictions

There are some restrictions when using MODFLOW-LGR:

- Streams created using the STR and SFR packages in GMS using the conceptual modeling approach cannot cross parent/child grid boundaries. GMS does nothing to split the stream at the model boundary and connect the parent/child stream segments.
- When child grids are present, grid editing is restricted. Splitting, merging, redistributing, and resizing grid rows, columns and layers is not allowed on child grids and not allowed in the parent grid if the rows, columns or layers intersect with a child grid.
- Parameters may be created and used but only to do a forward run, not for parameter estimation, stochastic, or stochastic inverse runs.

- MODPATH can only be used with the parent grid

MODFLOW-LGR Files

Below are tables of some of the available input and output files for MODFLOW-LGR.

- For more information on these files see the [manual](#)

Required Input Files

Name	Description
MFN	MODFLOW Name File
GLO	Global Listing File
DIS	Discretization File
OC	Process Output Control Option File
BA6	Basic Package Global Options File

Solver Package File

Name	Description
DE4	Direct
GMG	Geometric Multi-Grid
LMG	Link Algebraic Multi-Grid
PCG	Preconditioned Conjugate-Gradient
SIP	Strongly Implicit Procedure

Input Flow Package Files

Name	Description
BCF	Evapotranspiration Segments
HUF	Evapotranspiration
LPF	Layer Property Flow

Optional Package Files

Name	Description
ASP	PEST Advanced Spacial Parameterization
BFH	Boundary Flow and Head
CHD	Time-Variant Specified-Head
DRN	Drain
DRT	Drain Return
EVT	Evapotranspiration
ETS	Evapotranspiration Segments
GAG	Gage
GHB	General Head Boundary
HFB	Horizontal Flow Barrier
LAK	Lake
RCH	Recharge
RIV	River
SFR	Streamflow-Routing
STR	Stream-Routing
SUB	Subsidence
UZF	Unsaturated-Zone Flow
WEL	Process Well

Observation Input Files

Name	Description
OBS	Main Observation Process Input
DROB	Drain Observation
CHOB	Constant-Head Flow Observation Input

Output Files

Name	Description
MFS	MODFLOW Super File
MFW	GMS MODFLOW World File
MFR	GMS MODFLOW Result Index File
PRJ	Projection
CSV	Cell Summary Comma Separated Value Excel
HFF	Head and Flow File Link to MT3DMS
H5	Hierarchal Data Format (HDF5) Array & List Data
M2P	MODFLOW Pest
PARAM	Parameter Information

Output Results Files

Name	Description
CCF	Cell-to-Cell Aquifer Flow
CCF2	Cell-to-Cell Stream Reach Outflow
DRW	Drawdown
GLO	Global Listing
HED	Head Output
OUT	Output

Output Package Files

Name	Description
MNW	Multi-Node Well
MNW2	Multi-Node Well Version 2
MNWI	Multi-Node Well Information

Output Data Exchange Files

Name	Description
_W	Weighted Residuals
_WW	Weighted Equivalents & Weighted Observation
_WS	Weighted Residuals and Simulated Equivalents
_R	Unweighted Residuals
_OS	Observed Values and Simulated Equivalents
_B	Data Exchange File
_NM	Weighted Residuals and Probability Plotting

External Links

- [Online MODFLOW-LGR Manual](#)

MODFLOW-USG

MODFLOW-USG is a version of MODFLOW based on finite volume calculations, thus allowing for many different types of grid cells. This allows the model grid to more accurately match the model domain and be more efficiently refined in areas where more accuracy is desired.

MODFLOW-USG models are built using unstructured grids, or [UGrids](#), which are a new (as of GMS 10.0) type of geometric object that can handle the wide variety of cell types supported by MODFLOW-USG.

The MODFLOW-USG model is included with all [paid editions](#) of GMS.

Choosing MODFLOW Version

Only MODFLOW-USG is supported when using unstructured grids. MODFLOW-USG can also be used for a model using a [3D grid](#). Choosing to use MODFLOW-USG is done in the [MODFLOW Global Options dialog](#). With a 3D grid at any time the user can switch from one MODFLOW version to another.

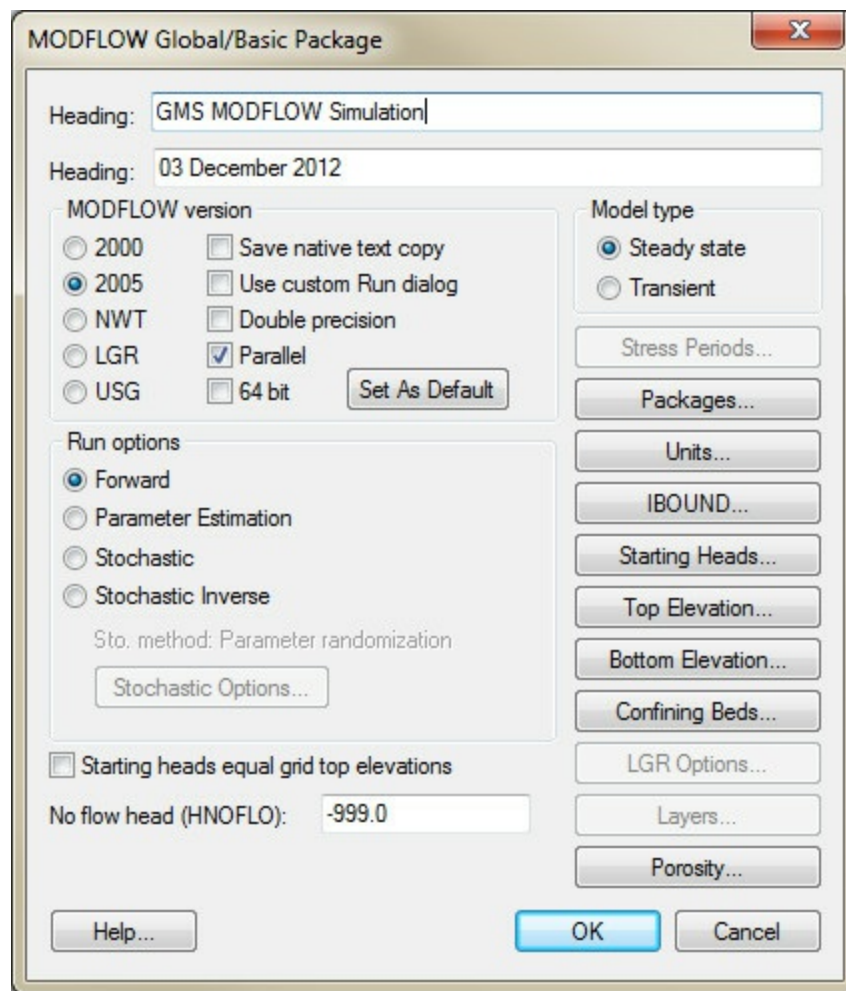

MODFLOW Global/Basic Package dialog.

Unsupported Features

Previous to GMS 10.1 there was no support for the following MODFLOW-USG features, though the CLN and GNC packages and the import feature are now supported in current versions of GMS.

1. Packages/processes

- CLN Process
- GNC Package

2. Older versions of GMS cannot read MODFLOW-USG files written by any non-GMS software. This is because there was no standard way to define the unstructured grid geometry. GMS writes a *.VTU ([Visualization Toolkit](#) unstructured grid) file with the MODFLOW files to define the grid geometry. In GMS 10.1 and later versions a model

that was created outside of GMS can be imported as long as there is either a *.vtu file (VTK unstructured grid file) or a *.gsf file ([Grid Specification File](#)) present to define the grid geometry because the MODFLOW-USG native input files do not include locations of the grid nodes ([unfortunately](#)).

Additionally, PEST-ASP is currently unsupported in MODFLOW-USG

MODFLOW-USG Files

Here are tables of some of the available input and output files for MODFLOW-USG.

- For more information on these files see the manual

Required Input Files

Name	Description
MFN	MODFLOW Name File
GLO	Global Listing File
DIS	Discretization File
OC	Process Output Control Option File
BA6	Basic Package Global Options File

Solver Package File

Name	Description
SMS	Sparse Matrix Solver

Input Flow Package Files

Name	Description
BCF	Block-Centered Flow
LPF	Layer Property Flow

Optional Package Files

Name	Description
CHD	Time-Variant Specified-Head
DRN	Drain
EVT	Evapotranspiration
GAG	Gage
GHB	General Head Boundary
GNC	Ghost Node Correction
HFB	Horizontal Flow Barrier
LAK	Lake
RCH	Recharge
RIV	River
SFR	Streamflow-Routing
STR	Stream-Routing
SUB	Subsidence
WEL	Process Well

Observation Input Files

Name	Description
OBS	Main Observation Process Input
DROB	Drain Observation
CHOB	Constant-Head Flow Observation Input

Output Files

Name	Description
MFS	MODFLOW Super File
MFW	GMS MODFLOW World File
MFR	GMS MODFLOW Result Index File
PRJ	Projection
CSV	Cell Summary Comma Separated Value Excel
HFF	Head and Flow File Link to MT3DMS
H5	Hierarchal Data Format (HDF5) Array & List Data
M2P	MODFLOW Pest
PARAM	Parameter Information

Output Results Files

Name	Description
CCF	Cell-to-Cell Aquifer Flow
CCF2	Cell-to-Cell Stream Reach Outflow
DRW	Drawdown
GLO	Global Listing
HED	Head Output
OUT	Output
VTU	Visualization Toolkit Unstructured Grid

Output Data Exchange Files

Name	Description
_W	Weighted Residuals
_WW	Weighted Equivalentents & Weighted Observation
_WS	Weighted Residuals and Simulated Equivalentents
_R	Unweighted Residuals
_OS	Observed Values and Simulated Equivalentents
_B	Data Exchange File
_NM	Weighted Residuals and Probability Plotting

External Files

- [MODFLOW-USG Manual 2013](#)

See also

- [Map → MODFLOW-USG](#)
- [MODFLOW-USG Observations](#)

MODFLOW Commands

The *MODFLOW* menu becomes active once the MODFLOW model has been built in GMS. The menu has two submenus: *Optional Packages* and *Advanced*. The commands in the *MODFLOW* menu are listed below:

New Simulation...

Creates a new MODFLOW simulation and brings up the [Global Options/Basic Package dialog](#). If a simulation exists then the current one will be deleted and a new one will be made.

Delete Simulation...

Deletes the current MODFLOW simulation.

Check Simulation...

Brings up the [Model Checker dialog](#). This generates a list of possible errors and warning messages in the top scrolling window.

Run MODFLOW...

Initiates the MODFLOW executable. GMS will ask if to save the project before running the executable.

Read Solution...

Opens a window to search for a previous MODFLOW solution.

Flow Budget...

Shows the model's [flow budget](#) as one zone (default) or multiple user defined zones.

Global Options...

Opens the [MODFLOW Global/Basic Package](#) dialog to set up a MODFLOW simulation.

HUF – Hydrogeologic Unit Flow...

Brings up the [HUF Package](#) dialog. This command is only available when the package option has been selected in the [MODFLOW Packages](#) dialog. For more information, see [HUF Package](#).

LPF Package...

Opens the flow dialog to insert hydrologic parameters. (May not be LPF) This

command is only available when the package option has been selected in the [MODFLOW Packages](#) dialog.

PCG – Pre. Conj.-Gradient Solver...

Opens the [MODFLOW PCG Package](#) solver dialog for the selected solver. (May not be PCG2)

UPW – Upstream Weighting...

Opens the [UPW Package](#) dialog. This command is only available when the package option has been selected in the [MODFLOW Packages](#) dialog.

NWT – Newton Solver...

Opens the [MODFLOW NWT Solver](#) dialog. This command is only available when the package option has been selected in the [MODFLOW Packages](#) dialog.

OC – Output Control...

Opens the [MODFLOW Output Control](#) dialog to choose what comes out of a MODFLOW run.

Optional Packages >

Use the [MODFLOW Packages](#) dialog to select which packages are active in the menu.

BCF – Block Centered Flow...

Opens the [MODFLOW Block Centered Flow Package](#) dialog. This command is only available when the package option has been selected in the [MODFLOW Packages](#) dialog. See [BCF Package](#) to learn more.

CHD – Time-Variant Specified-Head...

Starts the [MODFLOW Time Var. Head Package](#) dialog. See [CHD Package](#) to learn more.

CLN – Connected Linear Network...

Opens the [CLN Process](#) dialog. See [CLN Process](#) to learn more.

CLN Wel – CLN Well...

Opens the [MODFLOW CLN Wells Package](#) dialog. See [CLN Process](#) to learn more.

DRN – Drain Package...

Opens the [MODFLOW Drain Package](#) dialog. See [DRN Package](#) for more information.

DRT – Drain Return Package...

Brings up the *MODFLOW Drain return Package* dialog. To learn more, see [DRT Package](#).

EVT – Evapotranspiration...

Launches the *MODFLOW EVT Package* dialog. See [EVT Package](#) to learn more.

ETS – Evapotranspiration Segment...

Opens the *MODFLOW ETS Package* dialog. For more information, see [ETS Package](#).

GAGE – Gage...

Starts the *MODFLOW GAGE Package* dialog. See [GAGE Package](#) to learn more.

GHB – General Head Package

Opens the *MODFLOW General Head Package* dialog. For more information, see [GHB Package](#).

GNC – Ghost Node Correction Package

Opens the *MODFLOW Ghost Node Correction Package* dialog. For more information, see [GNC Package](#).

HFB – Horizontal Flow Barrier...

LAK – Lake Package...

Launches the *MODFLOW Lake Package* dialog. See [LAK Package](#) for more information.

MNW1 – Multi-Node Well...

Brings up the *Multi-Node Well (MNW1) Package* dialog. To learn more, see [MNW1 Package](#).

MNW2 – Multi-Node Well...

Brings up the *Multi-Node Well (MNW2) Package* dialog. This package is an updated version of the MNW1 Package. To learn more, see [MNW2 Package](#).

RCH – Recharge...

Starts the *MODFLOW Recharge Package* dialog. See [RCH Package](#) for more information.

RIV – River...

Opens the *MODFLOW River Package* dialog. To learn more, see [RIV Package](#).

PEST ASP...

Opens the *PEST-ASP Options* dialog. See [PEST ASP Package](#) for more information.

SFR2 – Streamflow-Routing...

Brings up the *MODFLOW Streamflow-Routing Package* dialog. To learn more, see [STR/SFR Packages](#).

STR – Stream...

Launches the *MODFLOW Stream Package* dialog. See [STR/SFR Packages](#) to learn more.

SUB – Subsidence...

Unsaturated Zone (UZF) Package...

WEL – Well...

Opens the *Well Package* dialog. To learn more, see [WEL Package](#).

Name File...

Opens the *Name File* dialog which allows editing file unit numbers and unsupported packages. To learn more, see [Name File dialog](#).

Parameters...

Brings up a *Parameters* dialog. Options available in this dialog will vary. To learn more, see [Standard MODFLOW Parameters](#).

Observations...

Opens an *Observations* dialog. See [Observations](#) for more information.

Parameter Estimation...

Becomes available when *Stochastic* or *Stochastic Inverse* is selected as the *Run Options* in the *MODFLOW Global/Basic Package* dialog. To learn more, see [PEST Dialog](#).

Stochastic...

Becomes available when *Stochastic* or *Stochastic Inverse* is selected as the *Run Options* in the *MODFLOW Global/Basic Package* dialog. The command brings up the *Stochastic Options* dialog. See [Stochastic Options Dialog](#) for more information.

Advanced >

Export Native MF2K Text...

Creates native MODFLOW files from existing GMS [MODFLOW-with-hdf5](#) files.

Display Options...

Opens the [Display Options](#) dialog showing the *MODFLOW* tab.

Sources/Sinks...

Launches the *MODFLOW Source/Sinks* dialog. For more information see, [MODFLOW Source/Sink Dialog](#).

Toggle Barrier

Creates a "no flow boundary" between two adjacent selected cells.

Cell Properties...

Brings up the *3D Grid Cell Properties* dialog. For more information, see [Cell Properties](#).

IFACE...

Opens the *MODPATH IFACE* dialog.

ITOP...

Brings up the *MODPATH ITOP* dialog.

Obsolete Commands

The following commands have been removed from the *MODFLOW* menu in the most recent versions of GMS.

Convergence Options...

See the **PEST-ASP...** command.

Related Topics

- [MODFLOW](#)

6.4.1. MODFLOW Packages

MODFLOW Packages Supported in GMS

MODFLOW is divided into a series of components called "packages." Each package performs a specific task. The input for each package is generally contained in a separate file. The MODFLOW packages supported by GMS are listed in the following tables.

The MODFLOW packages to be used in the MODFLOW simulation are specified in the *Packages* dialog. This dialog is accessed in the *Global Options\Basic Package* dialog. Some of the packages are always required for a simulation and some are optional. One of the flow model packages and one of the solver packages must be selected. Each of the boundary condition/source/sink packages is optional.

For any package not currently supported in GMS, the file associated with that package will be ignored when the model is imported. However, GMS keeps track of unsupported packages it encounters when reading the name file and, when the project is saved, GMS lists the unsupported packages in the name file and copies the unsupported package files from the old directory to the new directory.

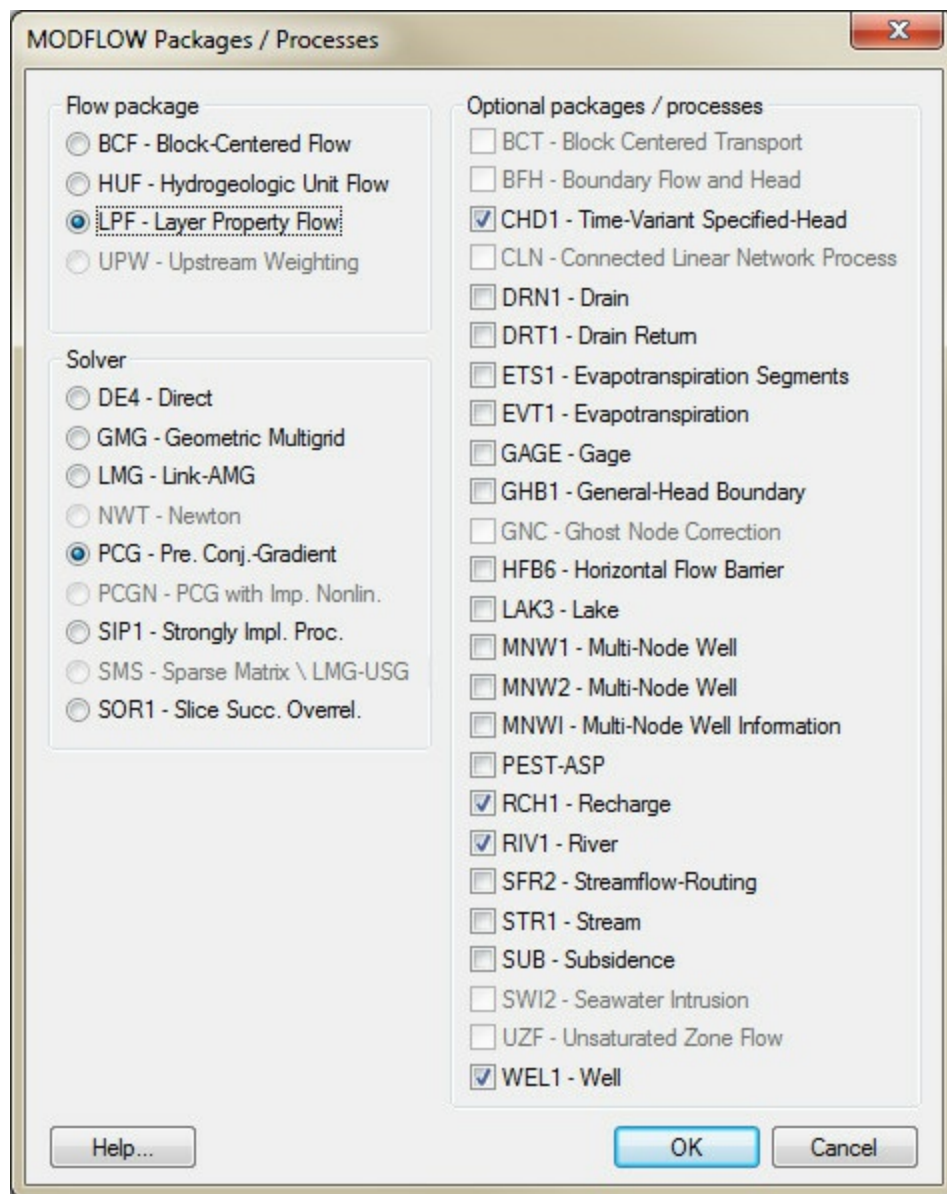

The MODFLOW Packages dialog.

After specifying packages for a MODFLOW simulation, the package parameters for each package can be reached through the *MODFLOW* menu; or by right-clicking on the package icon  in the Project Explorer and selecting the **Properties** command.

Global Options & Output

Abbrev.	Package/File Name	USGS	Description	Always Req'd?	Ext.
MFN	Name file	[1]	The MODFLOW name file. GMS uses "mfn" as the extension.	Yes	*.mfn
BAS6	Basic Package	[2]	Used to specify the grid dimensions, the computational time steps, and an array identifying which packages are to be used.	Yes	*.ba6
DIS	Discretization File	[3]	The Discretization File is used to specify certain data used in all models. These include, the number of rows, columns and layers, the cell sizes, the presence of Quasi-3D confining beds, the time discretization.	Yes	*.dis
OUT1	Output Control	[4]	Controls what information is to be output from MODFLOW and when it is to be output.	No	*.oc

Flow Packages

Interfaces to four different flow packages are provided in GMS: the block-centered flow ([BCF](#)), the layer property flow ([LPF](#)), the hydrogeologic unit flow ([HUF](#)), and the upstream weighting ([UPW](#)) packages. One of these four packages must be selected in the *Packages* dialog.

Abbrev.	Package Name	USGS	Description	Always Req'd?	Ext.
BCF6	Block-Centered Flow Package	[5]	Performs the cell by cell flow calculations. The input to this package includes layer types and cell attributes such as storage coefficients and transmissivity. Parameters for sensitivity analysis or parameter estimation are NOT supported.	Yes ¹	*.bcf
LPF	Layer Property Flow Package	[6]	Performs the cell by cell flow calculations. The input to this package includes layer types and cell attributes such as storage coefficients and transmissivity.	Yes ¹	*.lpf
UPW	Upstream Weighting Flow Package	[7]	Based on the LPF package. Modified to provide a linear formulation that can be used with the NWT solver.	Yes ¹	*.upw
HUF	Hydrogeologic Unit Flow Package	[8]	Defines the model stratigraphy in a grid independent fashion (in the vertical direction).	Yes ¹	*.huf

¹ One of the flow packages must be used.

Solver Packages

Abbrev.	Package Name	USGS	Description	Always Req'd?	Ext.
GMG	Geometric Multi-Grid	[9]	The Geometric Multigrid Solver is used to solve the finite difference equations in each step of a MODFLOW stress period.	Yes ²	*.gmg
SIP1	Strongly Implicit Procedure	[10]	The Strongly Implicit Procedure package is used to solve the finite difference equations in each step of a MODFLOW stress period.	Yes ²	*.sip
PCG	Preconditioned Conjugate Gradient Method	[11]	The Preconditioned Conjugate-Gradient package is used to solve the finite difference equations in each step of a MODFLOW stress period.	Yes ²	*.pcg
PCGN	Preconditioned Conjugate Gradient Solver with Improved Nonlinear Control	[12]	The Preconditioned Conjugate-Gradient package is used to solve the finite difference equations in each step of a MODFLOW stress period.	Yes ²	*.pcgn
SOR1	Slice-Successive Overrelaxation Method	[13]	The Slice-Successive Overrelaxation package is used to solve the finite difference equations in each step of a MODFLOW stress period.	Yes ²	*.sor
SAMG or LMG	Algebraic Multi-Grid for Systems Solver	[14]	The LMG or Link-AMG package is used to solve the finite difference equations in each step of a MODFLOW stress period.	Yes ²	*.lmg
DE4	Direct Solver	[15]	The DE4 package is used to solve the finite difference equations in each step of a MODFLOW stress period.	Yes ²	*.de4
NWT	Newton Solver	[16]	The NWT package is used to solve the finite difference equations in each step of a MODFLOW-NWT stress period.	Yes ²	*.nwt
SMS	Sparse Matrix Solver	[17]	The SMS package is used to solve the finite volume equations in each step of a MODFLOW-USG stress period.	Yes ²	*.sms

² One of these solvers must be selected in the *Packages* dialog.

Once a solver has been selected, the appropriate solver package dialog can be accessed through one of the solver commands (LMG, SIP, PCG2, or SSOR) in the *MODFLOW* menu. The default values shown in each dialog are typically adequate.

For more information on Solver Packages visit:

<http://water.usgs.gov/nrp/gwsoftware/modflow2000/MFDOC/index.html>

Optional Packages

Abbrev.	Package Name	USGS	Description	Always Req'd?	Ext.
BFH	Boundary Flow and Head Package	[18]	Used with MODFLOW-LGR to use coupled flows and heads when running parent or child model independently.	No	*.bfh_hed, *.bfh_flw
CLN	CLN Process		MODFLOW-USG process to simulate Connected Linear Network.	No	*.cln
DRN1	Drain Package	[19]	Simulates drain type boundary conditions.	No	*.drn
DRT1	Drain Return Package	[20]	Simulates drain return type boundary conditions.	No	*.drt
EVT1	Evapotranspiration Package	[21]	Simulates the effect of evapotranspiration in the vadose zone.	No	*.evt
ETS1	Evapotranspiration Segments Package	[22]	"allows simulation of evapotranspiration with a user-defined relation between evapotranspiration rate and hydraulic head."	No	*.ets
GAGE	Gage Package	[23]	Allows SFR and lake gaging stations. Gaging station prints time series values for gage location.	No	*.gag
GHB1	General Head Boundary Package	[24]	Simulates a general purpose head-dependent source/sink. Commonly used to simulate lakes.	No	*.ghb
GNC	Ghost Node Correction Package		Only in MODFLOW-USG, corrects for cells whose connector does not perpendicularly bisect the face.	No	*.gnc
HFB1	Horizontal Flow Barrier Package	[25]	Simulates the effect of horizontal flow barriers such as sheet piles and slurry trenches.	No	*.hfb
LAK3	Lake Package	[26]	A more sophisticated alternative to the typical approach of using the General head package to simulate the effect of lakes and reservoirs. Computes the stage based on the water budget unlike the GHB.	No	*.lak
MNW1	Multi-Node Well 1 Package	[27]	older revision of MNW package used to simulate wells that extend over more than one cell.	No	*.mnw
MNW2	Multi-Node Well 2 Package	[28]	updated revision of MNW 1 package used to simulate wells that extend over more than one cell.	No	*.mnw2
RCH1	Recharge Package	[29]	Simulates recharge to the groundwater from precipitation.	No	*.rch
RIV1	River Package	[30]	Simulates river type boundary conditions.	No	*.riv
SFR2	Streamflow-Routing Package	[31]	Simulates the exchange of water between the aquifer and surficial streams. Includes routing and automatic computation of stage. Parameters for sensitivity analysis or parameter estimation are NOT supported.	No	*.sfr
STR1	Stream-Routing Package	[32]	Simulates the exchange of water between the aquifer and surficial streams. Includes routing and automatic computation of stage. Parameters for sensitivity analysis or parameter estimation are NOT supported.	No	*.str
CHD1	Time Variant Specified Head Package	[33]	Simulates specified head boundary conditions where the head is allowed to vary with time.	No	*.chd
SUB1	Subsidence Package	[34]	Simulates simulates aquifer compaction and land subsidence.	No	*.sub
SWI2	Seawater Intrusion Package	[35]	Simulates variable-density seawater intrusion in MODFLOW-2005.	No	*.swi
WEL1	Well Package	[36]	Simulates injection/extraction wells.	No	*.wel
UZF1	Unsaturated-Zone Flow Package	[37]	Simulate percolation of water through the unsaturated zone.	No	*.uzf

Other Files

Other files that GMS reads and writes with MODFLOW simulations.

File Name	Description	Ext.
MFS	MODFLOW "Super" file, created by GMS to keep track of extra information GMS needs.	*.mfs
MFW	MODFLOW World file , created by GMS to keep track of the geographic location of a MODFLOW model.	*.mfw
PRJ	Projection file in ArcGIS well-known text format specifying a geographic coordinate system.	*.prj
H5	An HDF5 formatted file containing array and list data referenced from other package files. See MODFLOW_with_HDF5 for more information	*.h5
ASP	An Advanced Spatial Parameterization file (unavailable in USG) used with a special version of MODFLOW modified to use PEST.	*.asp
PARAM	Extra information about the parameters used by GMS and our modified version of MODFLOW.	*.param
M2P	Used by MF2PEST.EXE program.	*.m2p

Output Files

Standard Extensions for OUTPUT files.

Package	Extension
	*.ccf
Drawdown	*.drw
Global	*.glo
Head	*.hed
Output	*.out

If a fort.# file occurs the MODFLOW file was written to the given unit number.

If a file has an underscore (*_...) followed by an extension, refer to pages 29 and 30 of the [MODFLOW Documentation](#).

BCF Package

NOTE: The observation, sensitivity, and parameter estimation processes do not support the BCF package.

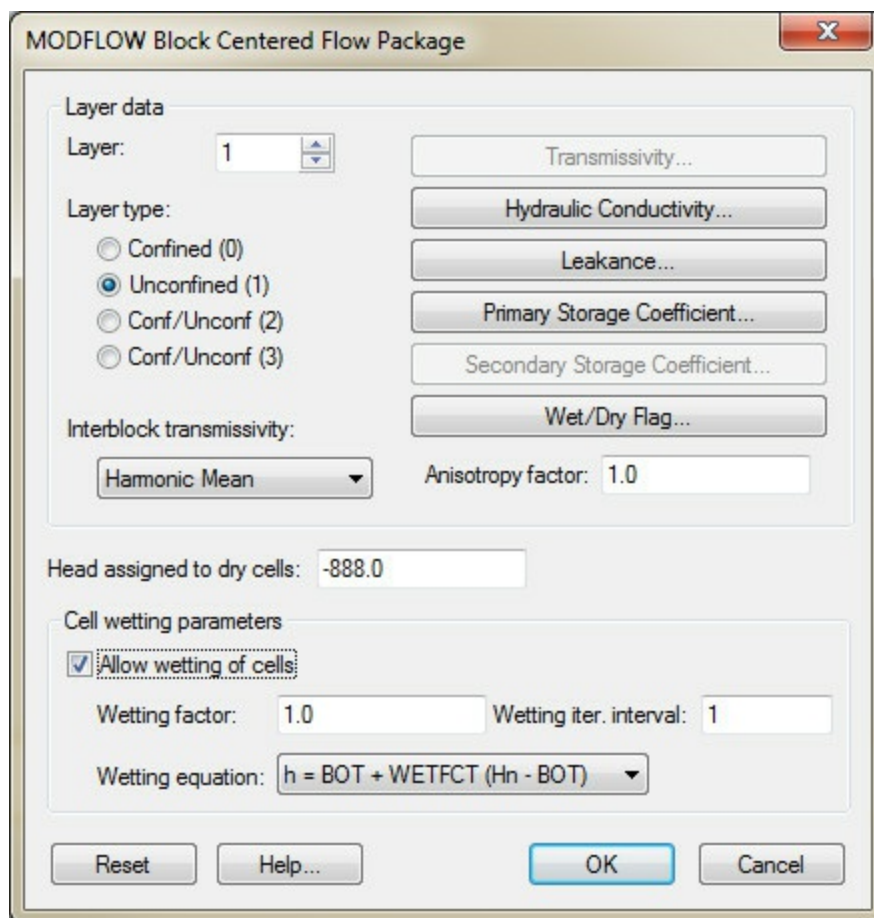

The image shows a screenshot of the 'MODFLOW Block Centered Flow Package' dialog box. The dialog has a title bar with a close button (X) in the top right corner. The main area is divided into several sections:

- Layer data:** A 'Layer:' dropdown menu is set to '1'. To its right are buttons for 'Transmissivity...', 'Hydraulic Conductivity...', 'Leakance...', 'Primary Storage Coefficient...', 'Secondary Storage Coefficient...', and 'Wet/Dry Flag...'.
- Layer type:** Four radio buttons are present: 'Confined (0)', 'Unconfined (1)' (which is selected), 'Conf./Unconf (2)', and 'Conf./Unconf (3)'.
- Interblock transmissivity:** A dropdown menu is set to 'Harmonic Mean'. To its right is an 'Anisotropy factor:' text box containing the value '1.0'.
- Head assigned to dry cells:** A text box containing the value '-888.0'.
- Cell wetting parameters:** A checked checkbox labeled 'Allow wetting of cells'. Below it are 'Wetting factor:' and 'Wetting iter. interval:' text boxes, both containing '1.0'. At the bottom is a 'Wetting equation:' dropdown menu set to 'h = BOT + WETFCT (Hn - BOT)'.

At the bottom of the dialog are four buttons: 'Reset', 'Help...', 'OK', and 'Cancel'.

The MODFLOW Block Centered Flow Package dialog.

Once the data in the [Global Options/Basic package](#) are initialized, the data for the flow package can be defined. The Block-Centered Flow (BCF) package is one of three flow packages that can be used. The BCF package computes the conductance between each of the grid cells and sets up the finite difference equations for the cell to cell flow. It also computes the terms that determine the rate of movement of water to and from storage. The *BCF Package* dialog is accessed through the **BCF Package** command in the *MODFLOW* menu.

Data Required

Data arrays required for a particular layer are dependent on the layer type. The layer arrays required for each layer type are shown in the following table. The leakance array is not required for the bottom layer and the storage coefficients are only required for transient simulations.

Layer Type	Required Arrays
Confined (LAYCON=0)	Transmissivity, Leakance, Primary Storage Coefficient (Storativity)
Unconfined (LAYCON=1)	Bottom Elevation, Hydraulic Conductivity, Leakance, Primary Storage Coefficient (Specific yield)
Confined/Unconfined (LAYCON=2)	Top Elevation, Transmissivity, Leakance, Primary Storage Coefficient (Storativity), Secondary Storage Coefficient (Specific yield)
Confined/Unconfined (LAYCON=3)	Top Elevation, Bottom Elevation, Hydraulic Conductivity, Leakance, Primary Storage Coefficient (Storativity), Secondary Storage Coefficient (Specific yield)

Each of the required input arrays must be entered by the user for each layer. Some of the layer arrays can be directly entered. However, some are dependent on the layer geometry. For example, leakance is a function of the layer thickness and the vertical hydraulic conductivity. The transmissivity is equal to the horizontal hydraulic conductivity multiplied by the layer thickness.

The BCF Package can be used for simple models with a single layer for multiple layers with simple stratigraphy. In such cases, many of the parameters are constant for an entire layer and can be entered directly. For more complex models, the following steps can be taken to prepare the input arrays (or the user can use the [LPF package](#)):

1. Import a set of scatter points defining the elevations of the stratigraphic horizons.
2. [Interpolate](#) the top and bottom elevations of each unit to a 2D grid which matches the 3D computational grid.
3. Compute the desired parameter arrays using the interpolated elevation arrays and the Data Calculator.
4. Copy the parameter arrays into the appropriate MODFLOW arrays in the *BCF Package* dialog.

Since this approach can be quite time-consuming, the LPF Package is recommended for most models.

Layer Data

The aquifer properties are entered in the *layer data* section.

Layer

The *layer edit* field is used to select the layer. The buttons on the right side of the dialog apply to the active layer only.

Layer Data Arrays

The six buttons on the right portion of the dialog represent layer data arrays such as elevations and hydraulic conductivity. Each of the six buttons brings up a dialog for entering an array of values. The dialog can be used to edit individual values, assign a constant value to the entire array, or to copy a dataset generated by interpolating from a scatter point set to the array.

Not all of the data arrays need to be specified for each layer. Some arrays are only required for transient models. The required arrays depend on the layer type.

Layer data arrays can also be edited using other tools in GMS. The array values can be edited by selecting a set of cells and using the [Cell Properties](#) command. The values in the layer parameter arrays can be initialized using coverages of a conceptual model defined in the [Map module](#). A set of tools for rapidly defining top and bottom elevations is provided (See [Defining Layer Elevations](#)). Layer data can also be assigned using material zones.

Layer Type

Each layer must be assigned a layer type (LAYCON). By default, the top layer is defined to be an unconfined layer and all other layers are initialized as confined. The data arrays required by a layer may be dependent on the layer type. Only one layer type can be assigned to each grid layer.

Interblock Transmissivity

The method used for computing interblock transmissivity is specified using the pull-

down list in the middle right portion of the *BCF Package* dialog.

Anisotropy Factor

This edit field allows the user to adjust the anisotropy that should be used in the model.

This value is defaulted to 1.0.

Head Assigned to Dry Cells

This edit field allows the user to adjust the default head value assigned to dry cells.

This value is defaulted to -888.0 or -999.0.

Cell Rewetting Parameters

The controls related to rewetting cells in the lower left portion of the *BCF Package* dialog are only activated if the BCF2 or BCF3 package has been specified. If wetting of cells is to be allowed, a wetting factor, wetting iteration interval, and wetting equation must be specified.

Storage coefficients

Name	Description	Units
Storativity	"the volume of water released from storage per unit decline in hydraulic head in the aquifer, per unit area of the aquifer"	unitless
Specific Storage (S _s)	"the amount of water that a portion of an aquifer releases from storage, per unit mass or volume of aquifer, per unit change in hydraulic head"	1/L
Specific Yield (S _y)	"also known as the drainable porosity, is a ratio, less than or equal to the effective porosity, indicating the volumetric fraction of the bulk aquifer volume that a given aquifer will yield when all the water is allowed to drain out of it under the forces of gravity"	unitless

BFH Package

The Boundary Flow and Head (BFH) package is available with [MODFLOW-LGR](#). This package allows the child and parent models to be simulated independently using the boundary conditions obtained through the iterative process of LGR.

The BFH package reads input data from the file indicated in the name file using the file type BFH. Input for the BFH package is created by LGR and requires that the coupling boundary conditions calculated by LGR be saved using variable of the LGR input file.

The *BFH Package* dialog has the following options:

- *Specify head file (child model)*
 - *Head unit #* – A number greater than zero that corresponds to the unit number where the boundary heads are saved for later use by the BFH package for independent simulations. A value of zero indicates that the file is not written.
 - *Head file* – The file containing the name file for the child model. Click to the **Browse** button to select the file.
- *Specify flow file (parent model)*
 - *Flow unit #* – A number greater than zero that corresponds to the unit number where the boundary fluxes are saved for later use by the BFH package for independent simulations. A value of zero indicates that the file is not written.
 - *Flow file* – The file containing the name file for the child model. Click to the **Browse** button to select the file.

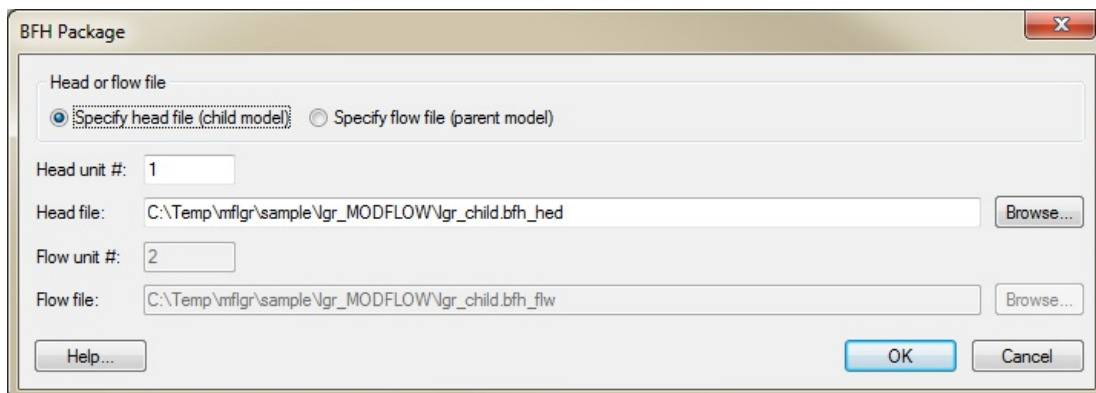

The GMS MODFLOW BFH Package dialog

External Links

- [BFH package documentation](#)

CHD Package

In the original version of MODFLOW, specified head boundaries are defined using a combination of the [IBOUND](#) array and the starting heads array. Since both of these arrays are static, boundaries where the head varies with time could not be simulated. To address this type of boundary, a new package called the Time Variant Specified Head (CHD) package has been developed. The Constant Head Designation (CHD) reads data every stress period, which makes changing the head at constant-head cells (designated with a negative IBOUND value) throughout a simulation possible.

NOTE: GMS does not support parameters for the Time Variant Specified Head (CHD) package.

Specifying Transient Head Values

Transient data are handled in a unique fashion with the CHD package. When transient values are assigned to the other stress packages, one value is assigned per [stress period](#). The value represents the value at the beginning of the stress period. This results in a stair step definition of the time series as shown in part a of the following figure. With the CHD package, two values are assigned per stress period: a value at the beginning of the stress period and a value at the end of the stress period. This makes it possible to specify a piece-wise linear time series as shown in part b.

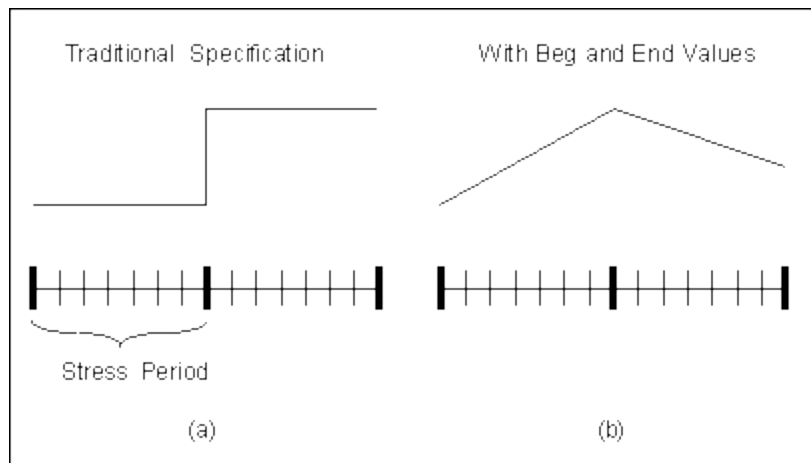

Specifying Transient Values Using (a) the Traditional Approach and (b) the Approach Used in the CHD Package.

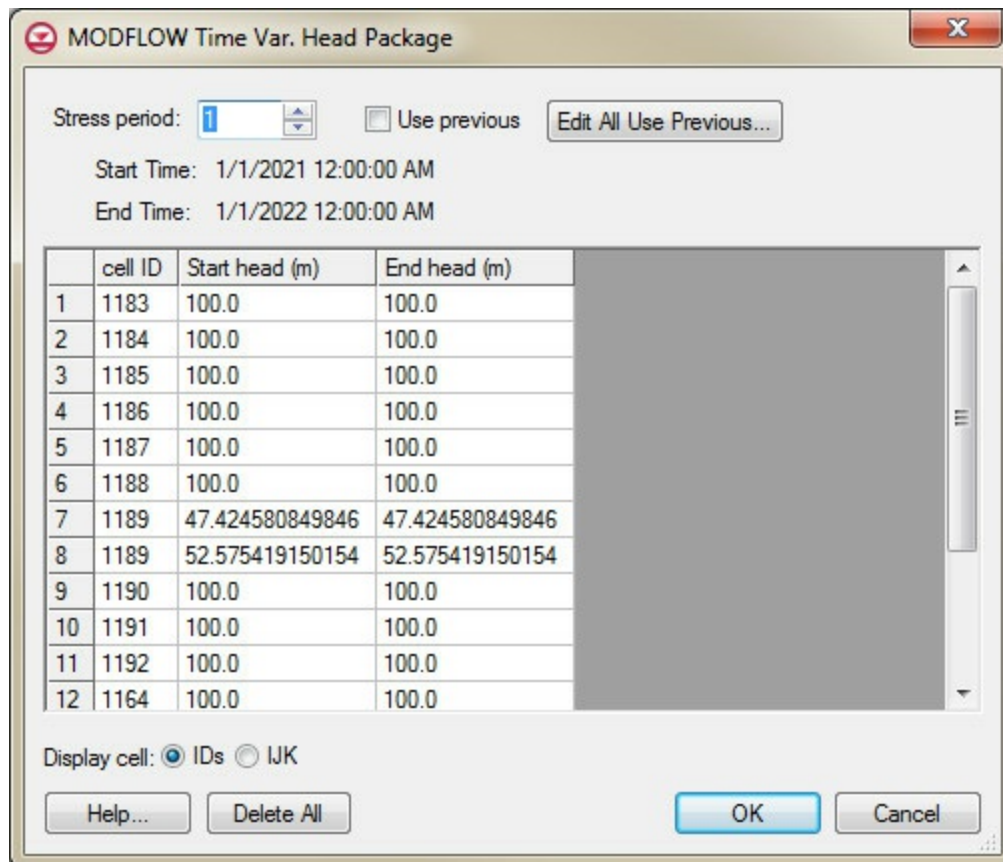

The MODFLOW Time Var. Head Package dialog.

Defining Time Variant Specified Head Boundaries

A time variant specified head boundary can be defined using a [conceptual model](#) in the [Map module](#) simply by using the *Transient* option when entering the head value in the *Attributes*

dialog. When the specified head attribute is assigned to a polygon, the head is assigned uniformly over the entire polygon. When assigned to an arc, separate head values are applied to each of the nodes on the ends of the arc and the head is assumed to vary linearly between the nodes. When the attribute is assigned to a point, the head is assigned directly to the cell containing the point. For cell-by-cell editing, a selected set of cells can be designated as time variant specified head cells using the **Point Sources/Sinks** command described above. When the head vs. time values are entered using the *XY Series Editor*, two values (beginning and ending values) must be entered per stress period. Once a set of cells has been specified, the *Time Variant Specified Head Package* dialog can be used to view and edit the values assigned to the cells.

Stress Period

This field shows the current stress period and allows users to cycle through the stress periods and view the different head properties for those stress periods in the spreadsheet below.

Use Previous

Use this option on a stress period to use the values from the previous stress period for the current stress period. This option is unavailable for steady state models and the first stress period of transient models.

Edit All Use Previous

This button brings up a spreadsheet allowing the user to quickly edit the *Use Previous* flag for all stress periods.

Spreadsheet

For cells where CHD type boundary conditions have been assigned, the starting and ending heads assigned to each cell are displayed in the spreadsheet portion at the lower part of the dialog. The spreadsheet can be used to edit the row, column, layer, starting head, and ending head values. For a transient simulation, the values displayed in the spreadsheet are for an individual stress period. The values associated with other stress periods can be edited by entering the number of the desired stress period in the *stress period* edit box in

the center of the dialog. If the *Use previous* option is selected for a given stress period, the values from the previous stress period are used and the spreadsheet is dimmed.

Delete All

This button deletes all values in the dialog.

DE4 Package

The DE4 package or Direct Solver is one of the solvers available for MODFLOW. It requires reading in a DE4 file. The *MODFLOW DE4 Solver* package dialog will show the variables in the DE4 file. Variables include:

- *Comments (Text)* – Allows up to 199 characters.
- *Maximum number of iterations (ITMX)* – Per time step. Enter 1 for no iterations.
- *Maximum number of upper equations (MXUP)* – Impacts the amount of memory used by the package. Prints the actual number of equations in the upper part when the package runs.
- *Maximum number of lower equations (MXLOW)* – Impacts the amount of memory used by the package. Prints the actual number of equations in the lower part when the package runs.
- *Maximum bandwidth (MXBW)* – Impacts the amount of memory used by the package. Prints the actual band width plus 1 when the package runs.
- *Frequency of change of coefficients in [A] (IFREQ)* – Affects the efficiency of solution. Can be 1,2, or 3.
 - 1 = The flow equations are linear and that coefficients of simulated head for all stress terms are constant for all stress periods.
 - 2 = The flow equations are linear, but coefficients of simulated head for some stress terms may change at the start of each stress period.
 - 3 = A nonlinear flow equation is being solved, which means that some terms in [A] depend on simulated head.
- *Print flag for convergence information per time step (MUTD4)* – Can be 0, 1, or 2.
 - 0 = The number of iterations in the time step and the maximum head change each

iteration are printed.

- 1 = Only the number of iterations in the time step is printed.
- 2 = No information is printed.
- *Head change multiplier (ACCL)* – Normally this value is 1. A value greater than 1 may be useful for improving the rate of convergence when using external iteration to solve nonlinear problems.
- *Head change closure criterion (HCLOSE)* – Not used if not iterating, but a value must always be specified.
- *Interval for time step printing (IPRD4)* – Not used if not iterating, but a value must always be specified.

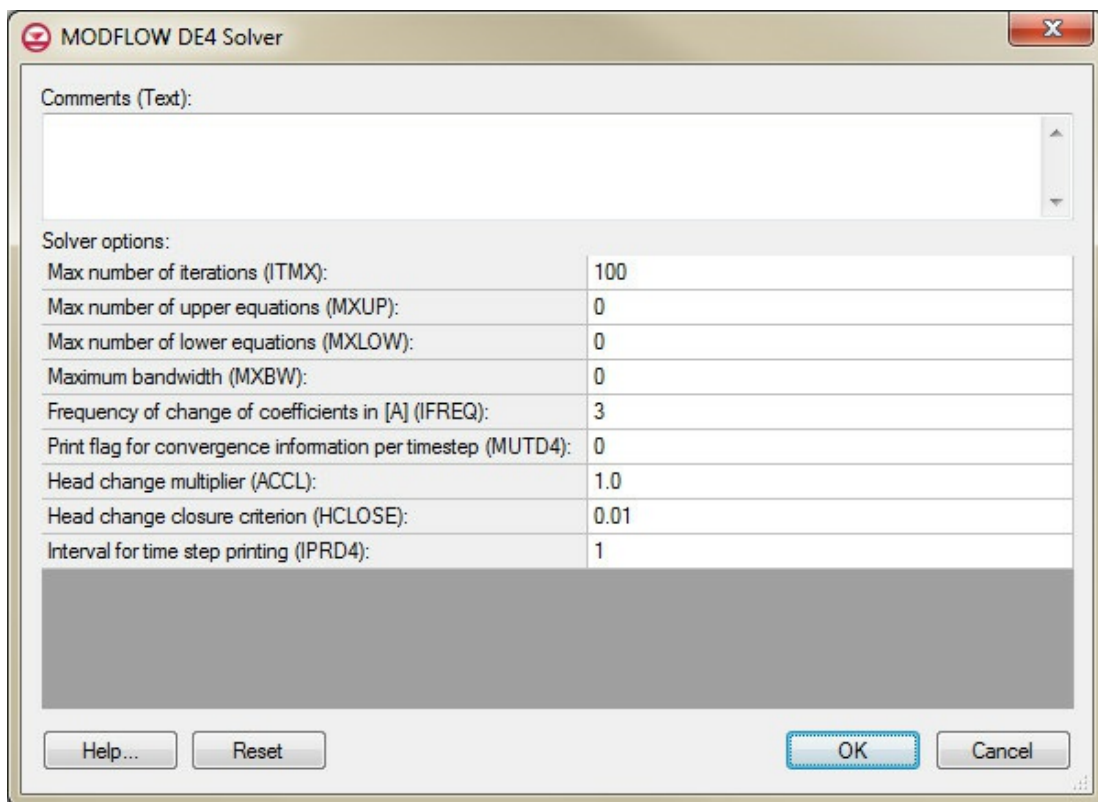

The MODFLOW DE4 Solver package dialog.

DE4 File Format

FOR EACH SIMULATION

0. [#Text]
1. ITMX MXUP MXLOW MXBW
2. IFREQ MUTD4 ACCL HCLOSE IPRD4

Item 0 is optional—“#” must be in column 1. Item 0 can be repeated multiple times.

See Also

- For more information on this solver see page 84 of the [USGS documentation](#).

DRN Package

The Drain (DRN) package is used to simulate the effect of drains on an aquifer. Drains remove water from the aquifer as long as the water table is above the elevation of the drain. If the water table falls below the elevation of the drain, the drain has no effect. The rate of removal is proportional to the difference in elevation between the water table and the drain. The constant of proportionality is the conductance of the fill material surrounding the drain.

A set of selected cells can be specified as drains using the **Point Sources/Sinks** command in the *MODFLOW* menu or drains can be defined using the [conceptual model](#) approach in the map module. Drains are specified by assigning an elevation and a conductance to each cell at the location of each drain.

The drain attribute may be associated with points, arcs, or polygons. There are two parameters that are associated with a drain: elevation and conductance. Elevation may be specified as a constant value or transient series, or interpolated from an existing TIN. Conductance may be constant or vary with time.

When a polygon is defined as a drain, the elevation and conductance values (constant or time-varying) are applied uniformly over the entire polygon. When an arc is assigned to be a drain, the conductance is applied uniformly over the arc but separate elevation values are applied to each of the nodes on the ends of the arc and the elevation is assumed to vary linearly between the nodes. When a point is classified as a drain, the elevation and conductance values are assigned directly to the cell containing the point.

See also the [Drain Return Package](#).

Stress Period

This field shows the current stress period and allows users to cycle through the stress periods and view the different river properties for those stress periods in the spreadsheet below.

Use Previous

Use this option on a stress period to use the drain values from the previous stress period for the current stress period. This option is unavailable for steady state models and the first stress period of transient models.

Edit All Use Previous

This button brings up a spreadsheet allowing the user to quickly edit the *Use Previous* flag for all stress periods.

Spreadsheet

For cells where drain type boundary conditions have been assigned, the conductance, elevation, and conductance factor assigned to each cell are displayed in the spreadsheet portion at the lower part of the dialog. The spreadsheet can be used to edit the row, column, layer, conductance, and elevation values. For a transient simulation, the values displayed in the spreadsheet are for an individual stress period. The values associated with other stress periods can be edited by entering the number of the desired stress period in the stress period edit box in the center of the dialog. If the Use previous option is selected for a given stress period, the values from the previous stress period are used and the spreadsheet is dimmed. The conductance factor is used, and only appears in the spreadsheet, with DRN parameter estimation. When doing parameter estimation the value of drain conductance assigned to a particular drain boundary condition will be the value of the drain parameter multiplied by the conductance factor. For more information on DRN parameters and conductance factors see the MODFLOW 2000 manual.

Display Cell IDs/IJK

The radio group at the bottom of the dialog allows the user to adjuster whether the cell ID or the cell i, j, k values are displayed for the cells containing the boundary condition/source/sink.

Delete All

The **Delete All** button deletes all of the data currently defined in the River package and

restores the River package parameters to the default values.

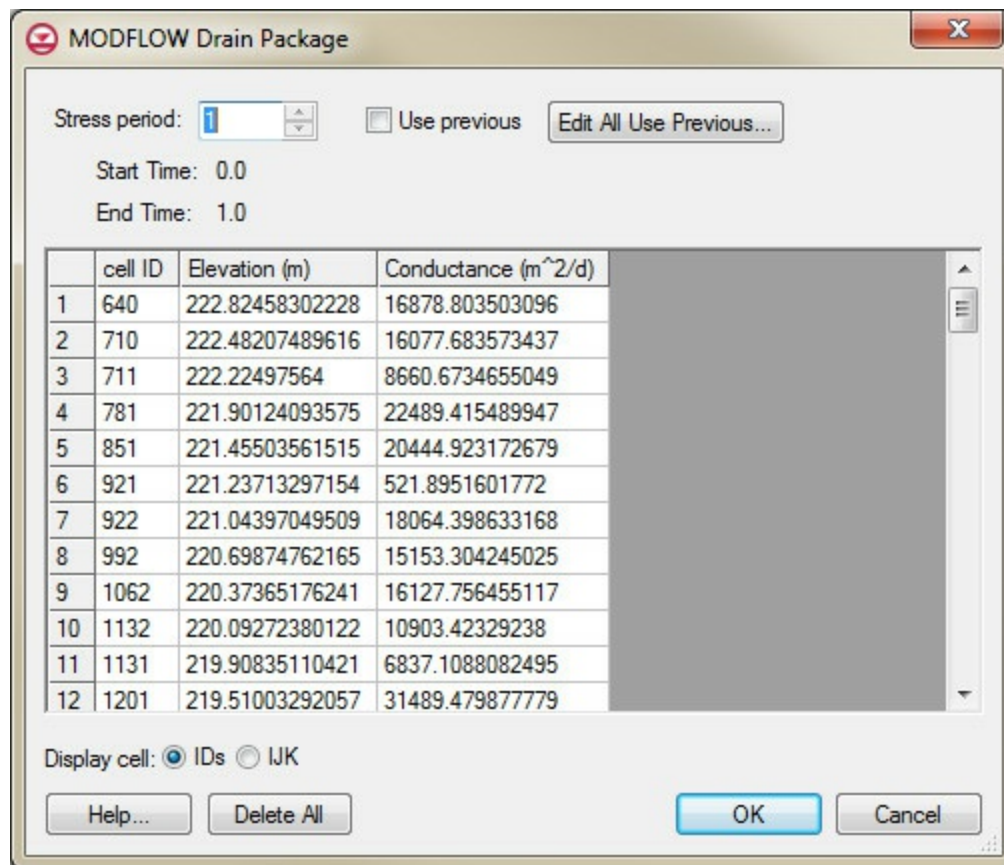

The MODFLOW Drain Package dialog.

DRT Package

The Drain Return (DRT) package is very similar to the regular [Drain \(DRN\) package](#). Drains remove water from the aquifer as long as the water table is above the elevation of the drain. With the DRT package, some percentage of that removed water can be reintroduced to the aquifer at a specified grid cell.

DRT boundary conditions can be added to selected cells using the **Point Sources/Sinks** command in the *MODFLOW* menu. DRT objects can also be defined using the [conceptual model approach](#) in the [Map module](#).

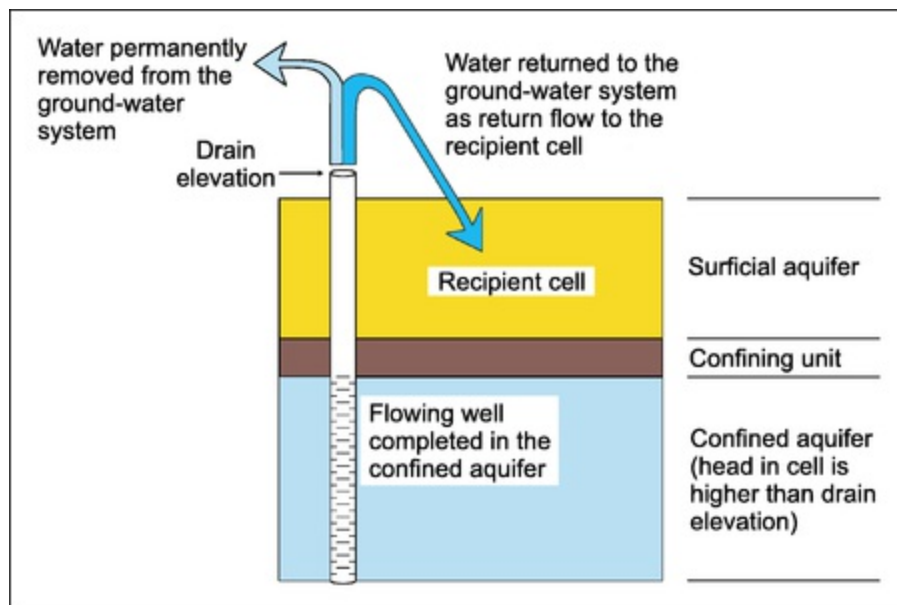

Illustration of DRT package.

Conceptual model

Drains can be modeled using points, arcs and/or polygons in a [conceptual model](#). The return cell cannot be specified in the conceptual model. This is because the conceptual model is independent of the grid and, in fact, there may be no grid at all when the conceptual model is defined. When GMS performs the **Map**→**MODFLOW** command, the return cell is always set to be the highest active cell above the drain cell. This can later be

changed in the *Drain Package* dialog.

The main DRT parameters and how they can be specified are given in the following table.

Parameter	Points	Nodes	Arcs	Polygons
Conductance	✓		✓	✓
Bottom elevation	✓	✓		✓
Rfprop (return-flow proportion)	✓		✓	✓

When specifying an arc as a DRT arc, the conductance and return flow factor are specified on the arc. Bottom elevation is specified at the nodes on the ends of the arc and is linearly interpolated along the length of the arc.

Care should be taken in entering **conductance** in the conceptual model so that the **units are correct**.

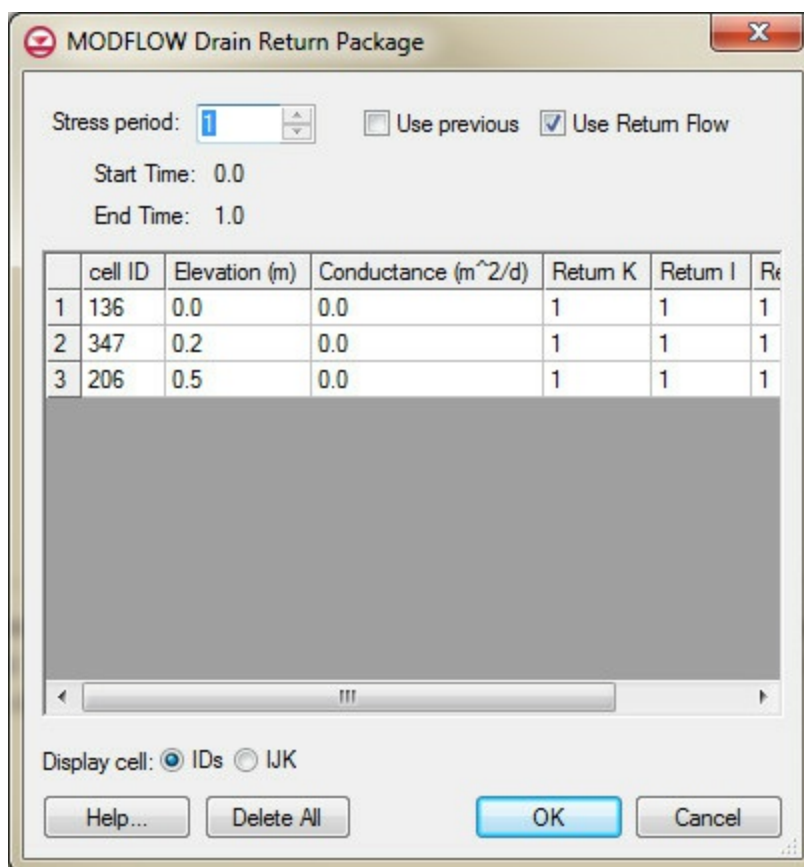

The MODFLOW Drain Return Package dialog.

Drain Return Package dialog

The *MODFLOW Drain Return Package* dialog allows the user to edit the location and the

input values associated with each drain boundary condition. Drain boundary conditions cannot be created or deleted from this dialog. They can be created and deleted via the **Map** → **MODFLOW** command, or by using the [MODFLOW Source/Sink dialog](#).

The *Use Return Flow* toggle controls the existence of the "RETURNFLOW" optional keyword in the package input file.

ETS Package

The EvapoTranspiration Segments (ETS) package is an enhancement of the [EVT](#) package and "allows simulation of evapotranspiration with a user-defined relation between evapotranspiration rate and hydraulic head." It is included in MODFLOW 2000 and GMS includes an interface to it starting at version 7.0.

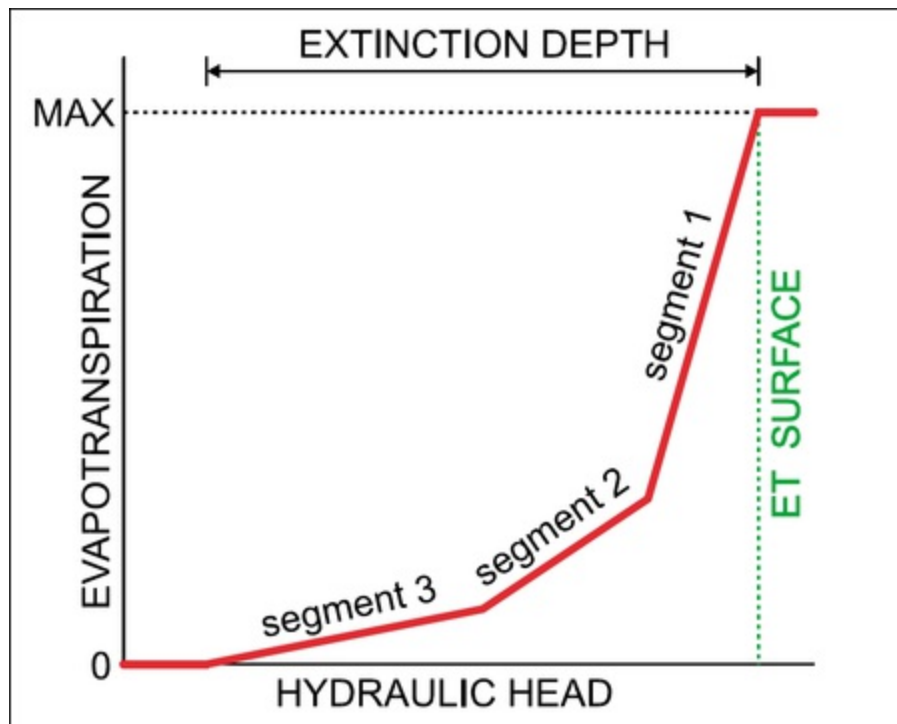

From OFR00-466

Evapotranspiration Segments

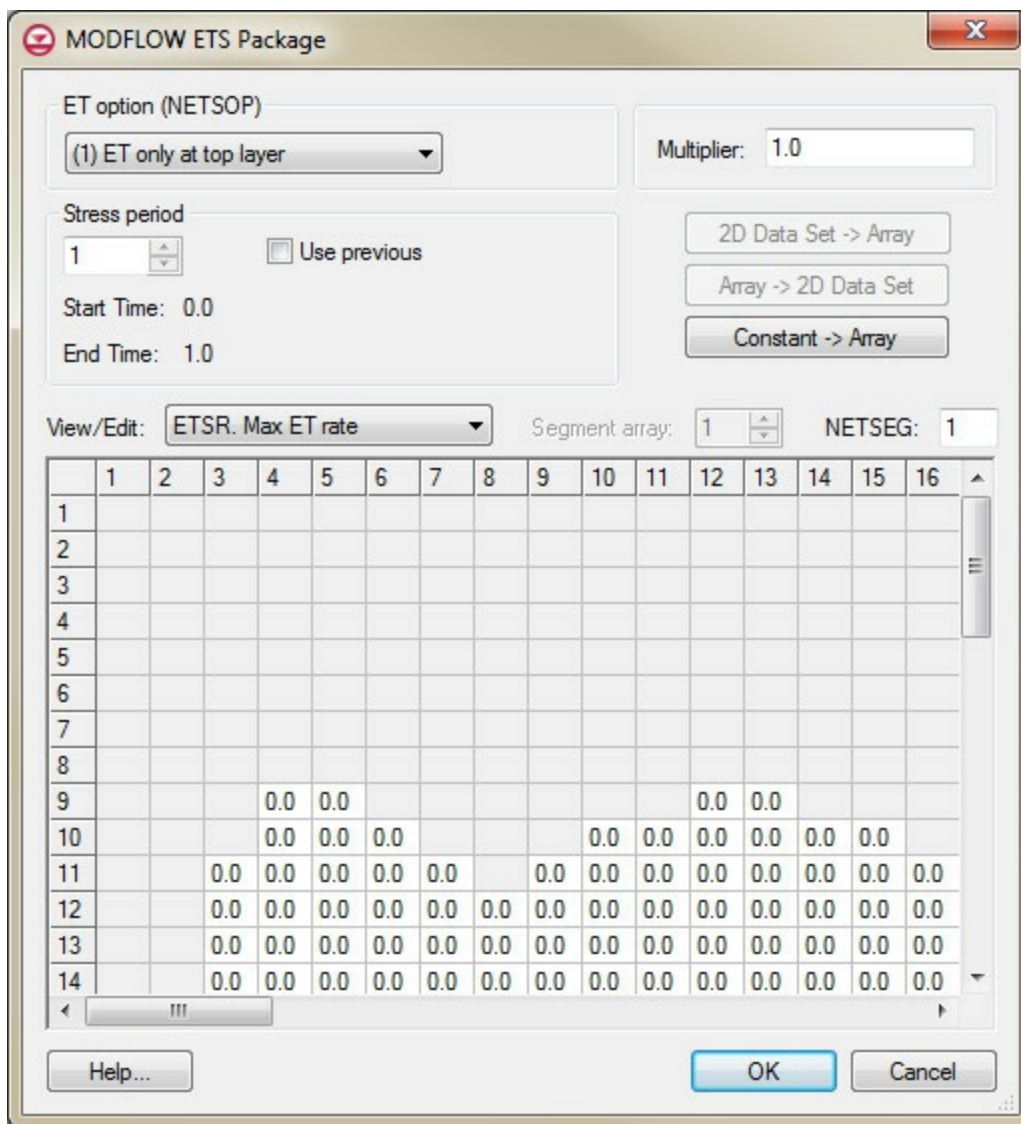

The MODFLOW ETS Package dialog.

From the package documentation:

In the ETS1 Package, the functional relation of evapotranspiration rate to head is conceptualized as a segmented line in the variable interval. The segments that determine the shape of the function in the variable interval are defined by intermediate points where adjacent segments join. The ends of the segments at the top and bottom of the variable interval are defined by the ET surface, the maximum evapotranspiration rate, and the extinction depth. The number of intermediate points that must be defined is one less than the number of segments in the variable interval. For each intermediate

point, two values, PXDP and PETM, are entered to define the point. PXDP is a proportion (between zero and one) of the extinction depth, and PETM is a proportion of the maximum evapotranspiration rate. PXDP is 0.0 at the ET surface and is 1.0 at the bottom of the variable interval. PETM is 1.0 at the ET surface and is 0.0 at the bottom of the variable interval. Segments are numbered such that segment one is the segment with its upper endpoint at the ET surface, and segment numbers increase downward. The relation of evapotranspiration rate to head is defined over the model grid by a series of two-dimensional arrays; therefore, PXDP and PETM also are specified as arrays.

The input order of the arrays defining the segmented line is important and is defined in the package documentation:

PXDP is a proportion of the extinction depth (dimensionless), measured downward from the ET surface, which, with PETM, defines the shape of the relation between the evapotranspiration rate and head. The value of PXDP must be between 0.0 and 1.0, inclusive. Repetitions of PXDP and PETM are read in sequence such that the first occurrence represents the bottom of the first segment, and subsequent repetitions represent the bottom of successively lower segments. Accordingly, PXDP values for later repetitions (representing lower segments) should be greater than PXDP values for earlier repetitions.

PETM is a proportion of the maximum evapotranspiration rate (dimensionless) which, with PXDP, defines the shape of the relation between the evapotranspiration rate and head. The value of PETM should be between 0.0 and 1.0, inclusive. Repetitions of PXDP and PETM are read in sequence such that the first occurrence represents the bottom of the first segment, and subsequent repetitions represent the bottoms of successively lower segments. Accordingly, PETM values for later repetitions (representing lower segments) generally would be less than PETM values for earlier repetitions.

Segmented line functions in GMS

In GMS, the ETS segmented line function can be defined in a conceptual model. When this is done, the standard *XY Series Editor* is used. The *XY Series Editor* is a simple tool for creating 2D curves. When used to define the ETS segmented function, the X values correspond to PXDP, and the Y values correspond to PETM. The order of the values is important and is defined by the package documentation as mentioned above. PXDP should be entered in order of increasing value, and PETM should be entered in order of decreasing value. Here are a couple of examples:

Values for Curve 1

PXDP	PETM
0.0	1.0
0.25	0.25
1.0	0.0

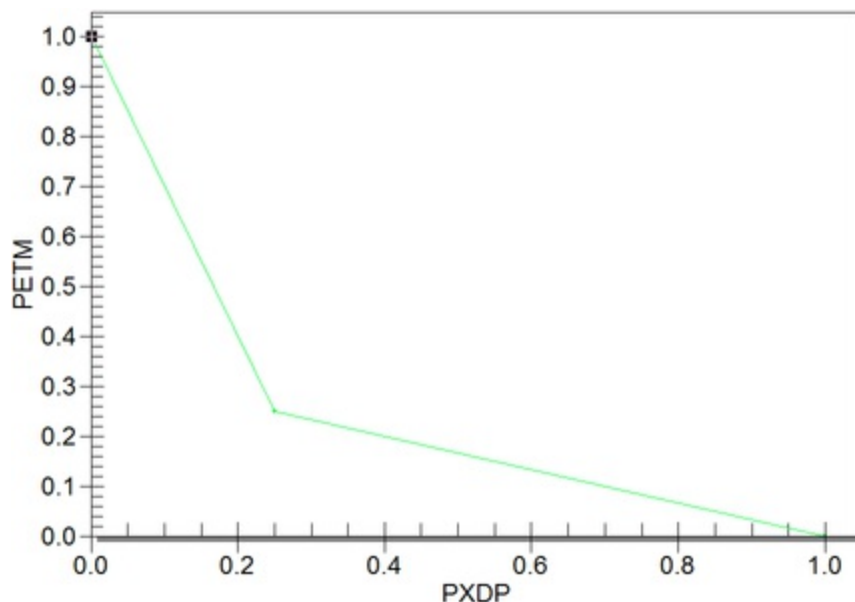

XY Series Curve 1 for ETS.

Values for Curve 2

PXDP	PETM
0.0	1.0
0.25	0.25
1.0	0.0

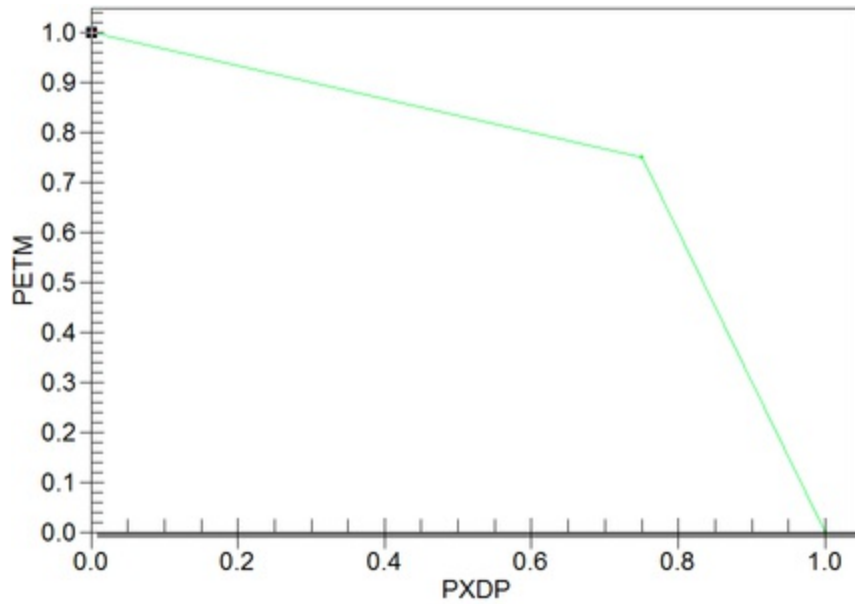

XY Series Curve 2 for ETS.

In a GMS conceptual model, it is not possible to define segmented lines which vary with time. However, this can be done in the *ETS Package* dialog.

EVT Package

The Evapotranspiration package is used to simulate the effect of plant transpiration and direct evaporation by removing water from cells during a simulation. Evapotranspiration (ET) is typically defined by specifying values for each [stress period](#) for each vertical column in the grid. The values consist of an elevation, an ET extinction depth, and a maximum ET rate. The elevation is an absolute elevation and the ET extinction depth (measured positive downward) is relative to the specified elevation. If the water table rises above the specified elevation, the evapotranspiration occurs at the maximum ET rate. If the water table falls below the ET extinction depth, evapotranspiration ceases. If the water table elevation lies between these two extremes, the evapotranspiration rate varies linearly with depth. The [ETS](#) package, a later extension of the EVT package, allows the rate to vary non-linearly.

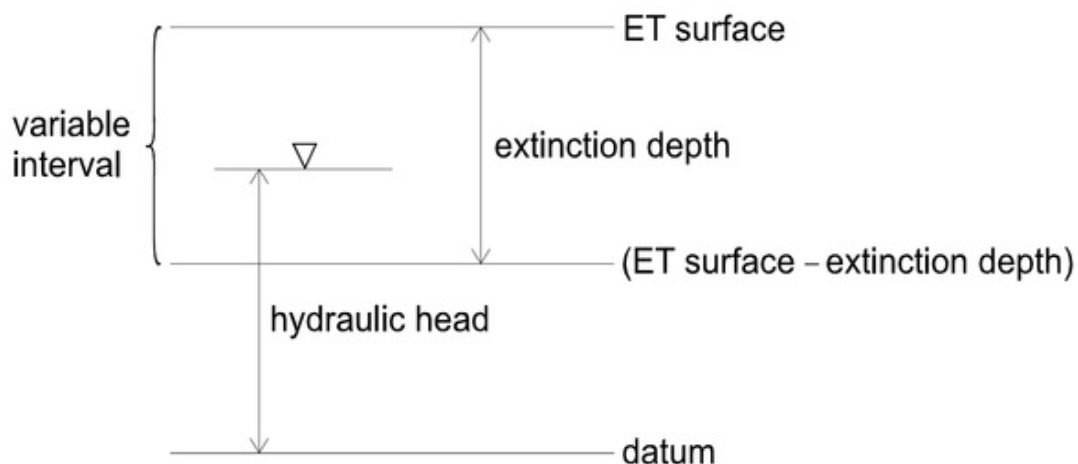

From OFR00-466

EVT Package Dialog

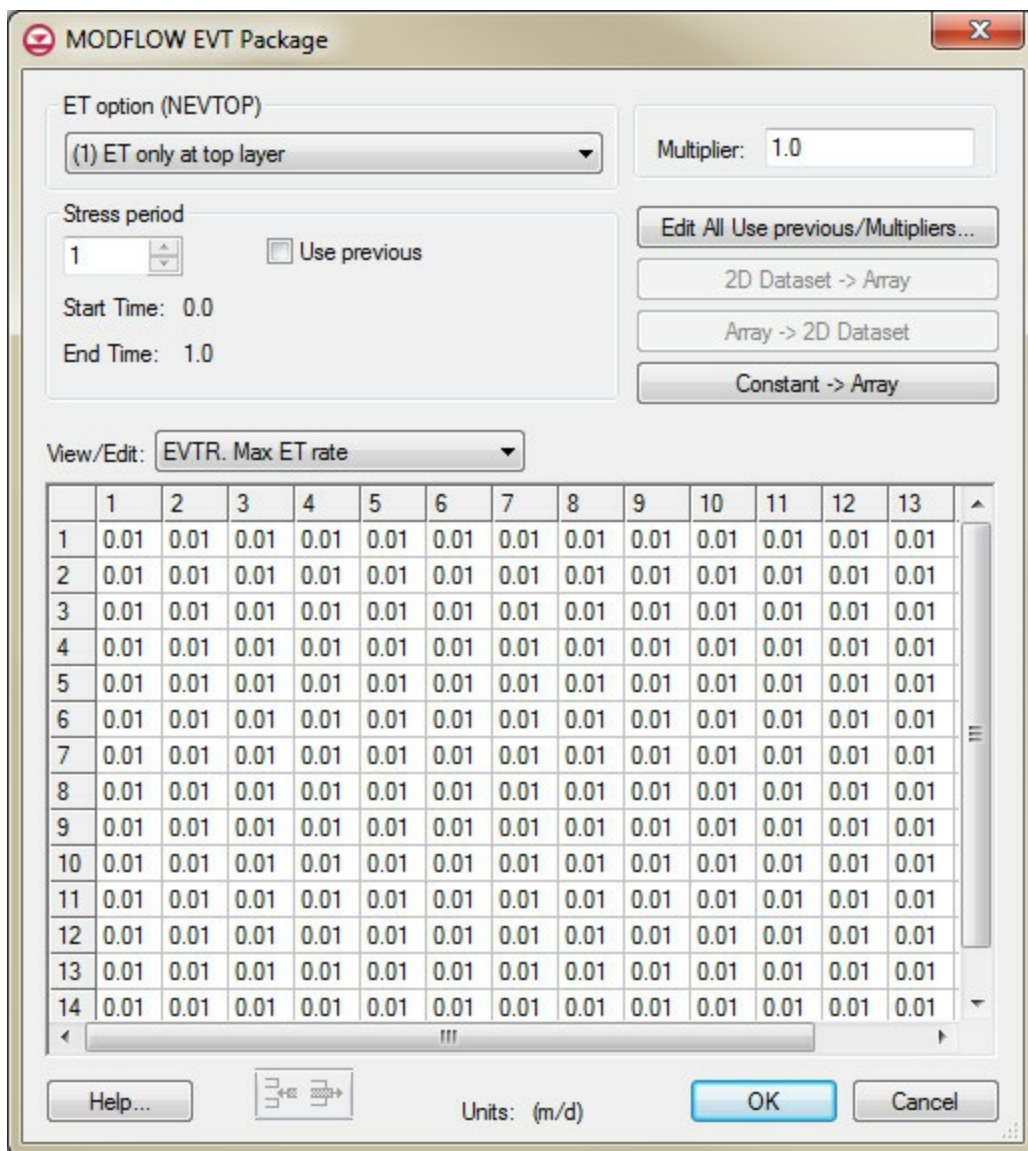

The MODFLOW EVT Package dialog.

The dialog for editing the evapotranspiration package input data is identical to the [Recharge Package dialog](#) except that rather than editing the flux and layer indicator arrays, the evapotranspiration arrays are edited: elevation, ET extinction depth, maximum ET rate, and layer indicator.

Evapotranspiration Option

Two ET options are supported by MODFLOW: ET only at the top layer, and ET at specified vertical cells.

Multiplier

The multiplier is a constant which can be written to the package file with each stress period array. Each value in the array is scaled by the multiplier as the array is imported to MODFLOW. The format button brings up a dialog listing the standard MODFLOW formats. This format is used for displaying the values in the spreadsheet and it controls how the values are written to the package file.

Stress Periods

The values displayed in the spreadsheet are for an individual stress period. The values associated with other stress periods can be edited by entering the ID of the desired stress period in the Stress period edit box in the center of the dialog. If the Use previous option is selected for a given stress period, the values from the previous stress period are used and the spreadsheet is dimmed.

Edit All Use previous/Multipliers

This button brings up a spreadsheet allowing the user to edit the *Use Previous* values and the multipliers for the active array for each stress period.

2D Dataset → Array

The **2D Dataset → Array** button brings up the *Data Browser* listing all of the current datasets associated with the current 2D grid. In order for this button to be active, the 2D grid must have the same number of rows and columns as the 3D grid. The selected dataset is copied to the recharge array. Datasets are typically generated with the 2D Scatter Point module. The 2D Scatter Point module can be used to interpolate from a scattered set of rainfall measurements to the cell locations. If the dataset is transient, the values in the dataset are linearly interpolated, if necessary, to each stress period as the dataset is copied to the array.

Array → 2D Dataset

The **Array → 2D Dataset** button copies the array to the 2D dataset list associated with the existing 2D grid.

Constant → Array

The **Constant** → **Array** button brings up a dialog which prompts for a single value. This constant is then assigned to each item in the array for the given stress period.

Spreadsheet

The spreadsheet allows editing for a 2D array of values, the type depending on the selection in the view/edit combo box. The array types include elevation, et extinction depth, and max ET rate.

See Also

- Learn more about evapotranspiration in MODFLOW [here](#).

GAGE Package

The MODFLOW Gage (GAGE) package allows gaging stations to be added to lakes and SFR stream reaches. A gaging station provides detailed time series data. MODFLOW generates a text file for each GAGE station that is available to be opened from a MODFLOW solution in the Project Explorer. GMS also provides an interface to generate gage plots via the *Plot Wizard*. A detailed description of the GAGE input is available at [the USGS website](#).

GAGE Package Dialog

Gaging stations can be directly added via the *GAGE Package* dialog. Stream gages are added in the table at the top using the SFR segment and reach for the desired cell. Lake gages are added in the table at the bottom using the lake ID. A button is also provided to easily add gage stations for all lakes in the model. The OUTTYPE column for both lakes and streams determines the data columns included in the text output.

The OUTTYPE options for SFR streams include:

- 0** – Default values including time, stage, outflow, and solute concentration.
- 1** – Default values plus depth, width, and flow at midpoint.
- 2** – Default values plus streambed conductance for the reach, head difference across streambed, and hydraulic gradient across streambed.
- 3** – Default values plus solute load in stream (if GWT is active).
- 4** – All of the above.
- 5** – Use for diversions to provide a listing of time, stage, flow diverted, maximum assigned diversion rate, flow at end of upstream segment prior to diversion, solute concentration, and solute load.
- 6** – Used for unsaturated flow routing to provide a listing of time, stage, ground-water head, streambed seepage, change in unsaturated storage, and recharge.
- 7** – Used for unsaturated flow routing to provide a listing of time and the unsaturated water content profile beneath the stream. Two profiles are printed. The first is the

volume average water content of ISUZN unsaturated cells beneath a stream reach.

The second profile is the volume averaged water content beneath the low flow channel only. If ISUZN =1 then both water content profiles will be the same.

The OUTTYPE for lakes include:

0 – Default values including time, stage, volume, and concentration.

1 – Default values plus all inflows to and outflows from lake (as volumes during time increment), and total lake conductance.

2 – Default values plus changes in lake stage, lake volume, and solute concentrations.

3 – All of the above except time-step budget error.

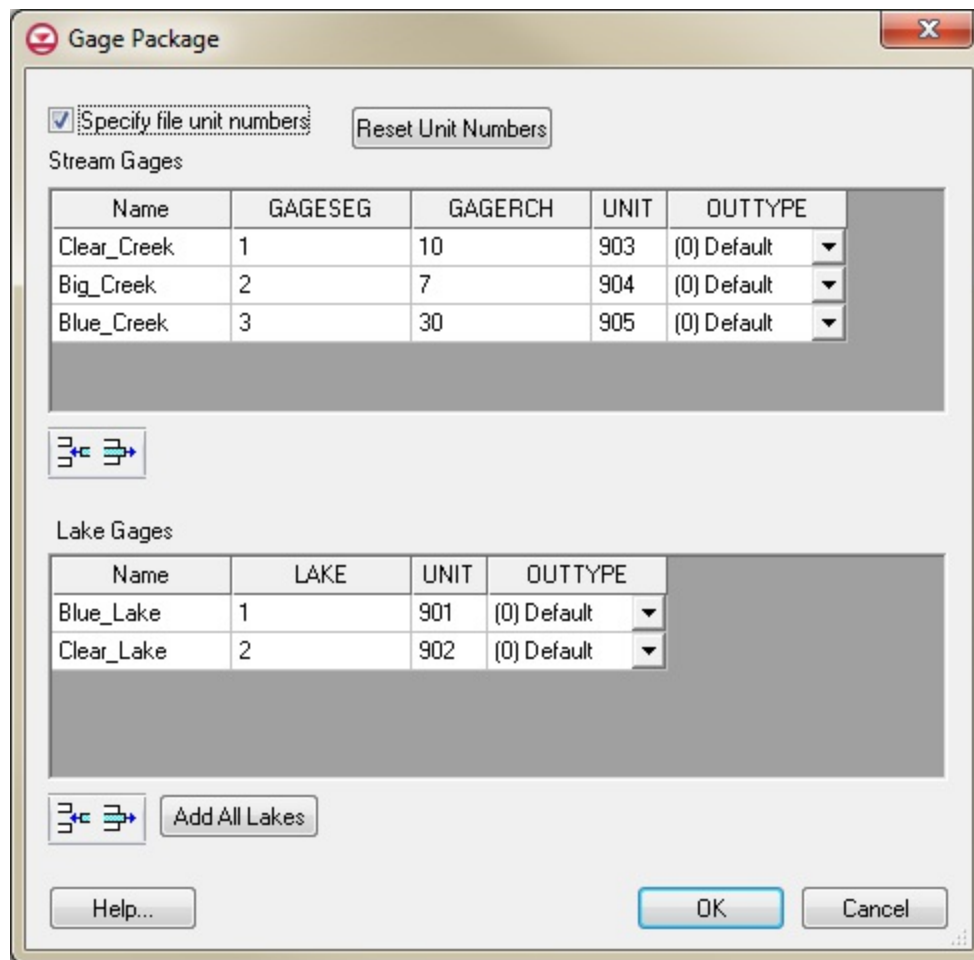

The GAGE Package dialog

GHB Package

General Head Boundary

The General Head Boundary (GHB) conceptually is a fixed head far from the model where it is assumed as a fixed head with time (i.e. river, head will not be affected by the model stresses with time). The purpose of using this boundary condition is to avoid unnecessarily extending the model domain outward to meet the element influencing the head in the model. As a result, the general head condition is usually assigned along the outside edge of the model domain.

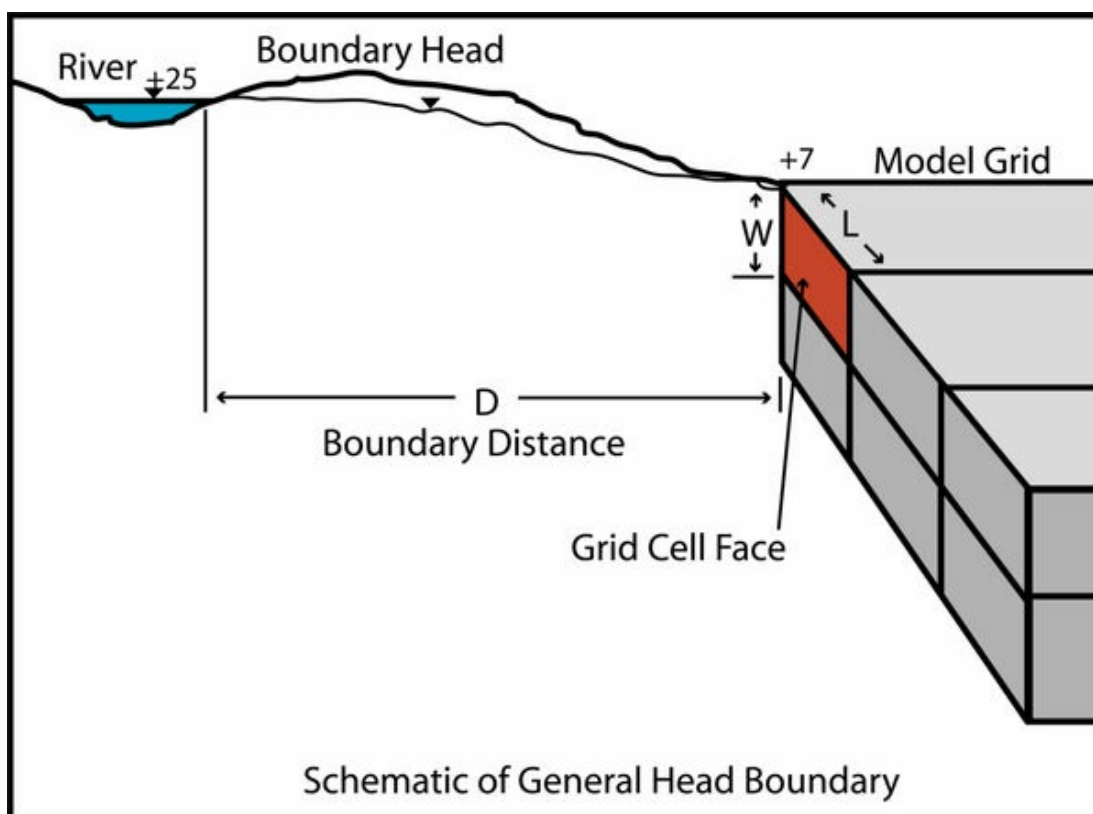

Schematic of General Head Boundary.

Where:

- K is the average hydraulic conductivity.
- W is the thickness of the saturated aquifer perpendicular to the flow direction.

- L is the boundary length perpendicular to the flow direction.
- D is the distance from the general head boundary to the model boundary.
- The GHB is the head at far distance where it is fixed (doesn't change with time)

The conductance for the arc = $K \times W \times \frac{L}{D} = 5 \times 100 \times \frac{1}{5000} = 0.1 \text{ m}^2/\text{day}$

General Head Package Dialog

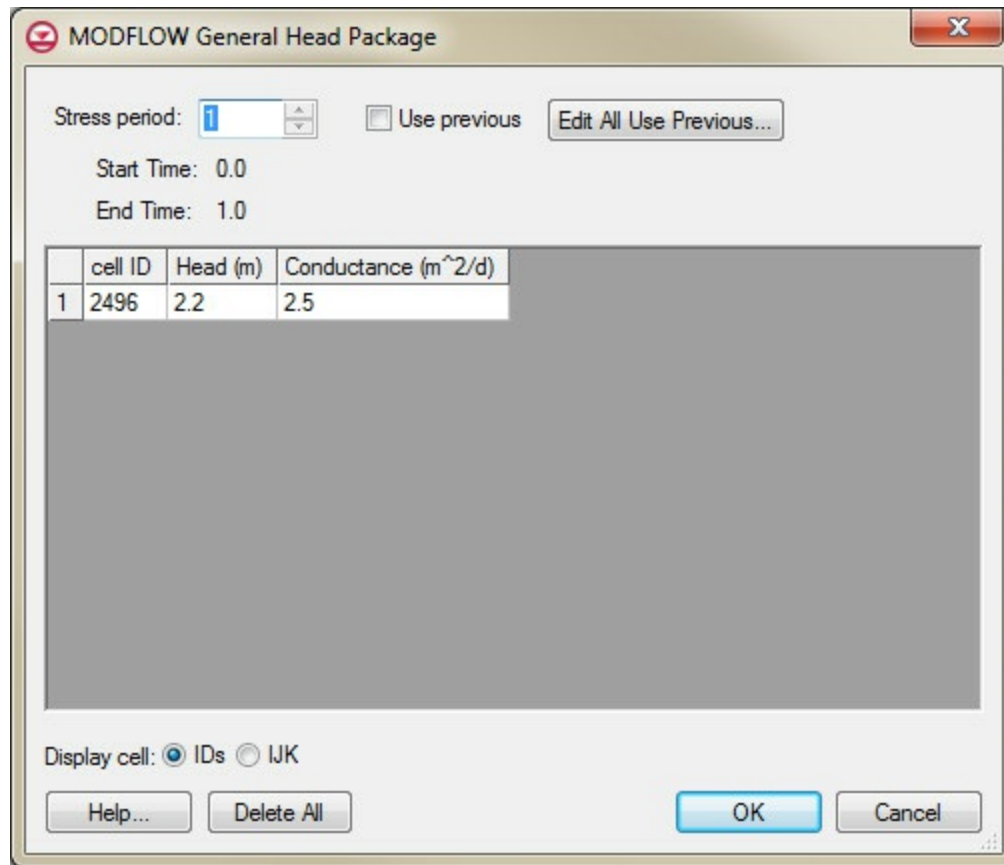

Example of the MODFLOW General Head Package dialog

The General Head package is similar to the [Drain](#) (DRN) and [River](#) (RIV) packages in that flow in or out of a cell is proportional to a difference in head. General head cells are often used to simulate lakes. General head conditions are specified by assigning a head and a conductance to a selected set of cells. If the water table elevation rises above the specified head, water flows out of the aquifer. If the water table elevation falls below the specified head, water flows into the aquifer. In both cases, the flow rate is proportional to the head difference and the constant of proportionality is the conductance.

A set of selected cells can be specified as general head cells using the **Point Sources/Sinks** command in *MODFLOW* menu or general heads can be assigned using the [conceptual model](#) in the [Map module](#). When the general head attribute is assigned to a polygons, the head and conductance are applied uniformly over the entire polygon. When assigned to an arc, the conductance is applied uniformly over the arc, but separate head values are applied to each of the nodes on the ends of the arc and the head is assumed to vary linearly between the nodes. When the attribute is assigned to a point, the head and conductance values are assigned directly to the cell containing the point. Once a set of cells have been specified, the *General Head Package* dialog can be used to view and edit the values assigned to the cells.

Stress Period

The stress period field shows the current stress period and allows users to cycle through the stress periods and view the different general head properties for those stress periods in the spreadsheet below.

Use Previous

Use this option on a stress period to use the general head values from the previous stress period for the current stress period. This option is unavailable for steady state models and the first stress period of transient models.

Edit All Use Previous

This button brings up a spreadsheet allowing the user to quickly edit the *Use Previous* flag for all stress periods.

Spreadsheet

For cells where river type boundary conditions have been assigned, the stage, conductance, bottom elevation, and conductance factor assigned to each cell are displayed in the spreadsheet portion at the lower part of the dialog. The spreadsheet can be used to edit the row, column, layer, head, and conductance values. For a transient simulation, the values displayed in the spreadsheet are for an individual stress period. The values associated with other stress periods can be edited by entering the number of the desired

stress period in the stress period edit box in the center of the dialog. If the Use previous option is selected for a given stress period, the values from the previous stress period are used and the spreadsheet is dimmed. The conductance factor is used with HFB parameters. When doing parameter estimation the value of head conductance assigned to a particular head boundary condition will be the value of the head parameter multiplied by the conductance factor. For more information on HFB parameters and conductance factors see the MODFLOW 2000 manual.

Display Cell IDs/IJK

The radio group at the bottom of the dialog allows the user to adjuster whether the cell ID or the cell i, j, k values are displayed for the cells containing the boundary condition/source/sink.

Delete All

The **Delete All** button deletes all of the data currently defined in the River package and restores the River package parameters to the default values.

Related Topics

- [Conductance](#)

Global Options/Basic Package

Once the MODFLOW simulation has been initialized, the next step is to enter the data required by the Global Options/Basic package. This includes data defining fundamental program options such as the computational time intervals (stress periods), an array defining which cells are inactive and which cells have constant heads, an array of starting head values for a transient simulation, and a set of flags defining which of the other packages are to be used. The input data for this package should be entered before editing any of the other packages. The MODFLOW *Global Options/Basic Package* dialog is accessed through the **Global Options** command in the *MODFLOW* menu.

The options in the dialog are as follows:

Headings

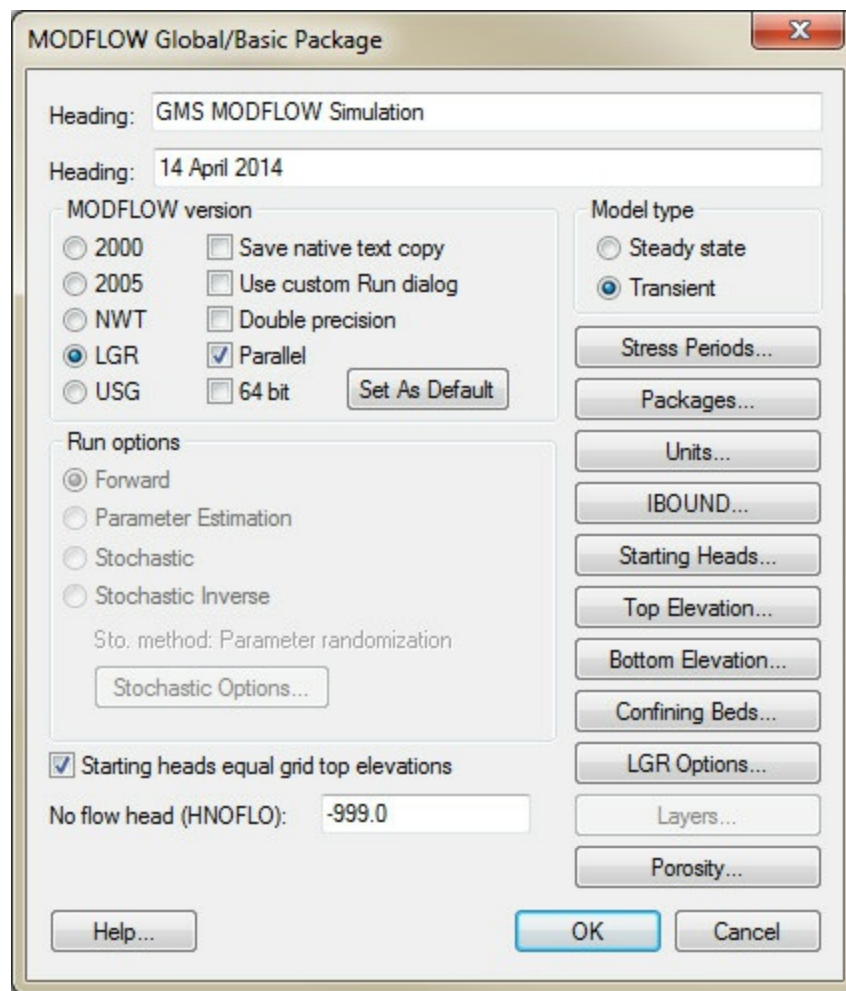

The MODFLOW Global / Basic Package dialog.

The two headings are optional text strings which are written to the MODFLOW text output file.

Version

The MODFLOW version can be specified with the choices being (as of Apr 2014):

- MODFLOW-2000
- MODFLOW-2005
- MODFLOW-NWT
- MODFLOW-LGR
- MODFLOW-USG

The type of binary executable can be specified using one or more of the following choices:

- Double precision – Uses 8 bytes rather than 4 bytes to store the number so they are more precise but calculations may take longer and binary files that store double-precision variables will be bigger than if single-precision had been used.
- Parallel – Enables parallel processing capabilities.
- 64 bit – Process using 64 bytes to store the number.

The *Save native text copy* option will save native ascii MODFLOW input files when the project is saved. An additional folder named *myProject_MODFLOW_text* is created that contains these files.

The *Use custom Run dialog* option will bring up the [Custom Run MODFLOW](#) dialog when the *MODFLOW | Run MODFLOW* menu command is selected.

The **Set as Default** button will set the selected model run options as the default MODFLOW model run options for GMS.

Run Options

The run options are not part of the actual MODFLOW input files, but present different ways that MODFLOW 2000 can be run from GMS.

Forward Run

A *Forward* run is a normal MODFLOW simulation. If parameters have been defined for either a stochastic or parameter estimation run, the mean or starting values of the parameters are used for the forward run.

Sensitivity Analysis

The *Sensitivity Analysis* option is used to perform a sensitivity analysis on a set of selected parameters. The results can be presented with a set of plots or by contouring datasets representing grid sensitivities. This option is only available with the [LPF and HUF flow packages](#). This option is not available in GMS 6.5 and later (see [MODFLOW with HDF5](#)).

After running PEST, sensitivities are displayed in the *.sen file. Click [here](#) for more information.

Parameter Estimation

In the *Parameter Estimation* mode, a set of parameters is found that minimizes the residual between observed and simulated heads and flows. These options are described in more detail on the [Automated Parameter Estimation](#) page. This option is only available with the [LPF and HUF flow packages](#).

Stochastic Simulation

The *Stochastic Simulation* option is used to perform a stochastic simulation using the [Monte Carlo](#) or [Latin Hypercube](#) methods for randomizing a selected set of parameters. Stochastic simulations can also be performed using a material set approach (indicator simulations). A risk analysis wizard can be used to analyze the results for a probabilistic threshold analysis or a probabilistic capture zone delineation. These options are described in more detail on the stochastic simulation page.

Stochastic Inverse Model

If the *Material Set* option is used for stochastic simulations, the *Stochastic Inverse* option can be used to perform automated parameter estimation on each of the N candidate model instances in the stochastic. The weighted RMS errors for each of the resulting optimized solutions can be used to weight the computations performed by the risk analysis wizard. This option is only available with the [LPF and HUF flow packages](#).

Model Type

The simulation can be designated as either *Steady state* or *Transient*. If a steady state simulation is specified, certain portions of the MODFLOW interface such as the *Stress Period* dialog are inactivated since they are not relevant.

No Flow Head

This is the value of head to be assigned to all inactive (no flow) cells (IBOUND=0)

throughout the simulation.

Stress Periods

The **Stress Periods** button is used to bring up the [Stress Period dialog](#). The stress periods should be defined before any of the sources/sinks are entered. If the steady state option is selected, the **Stress Periods** button is dimmed.

Packages

The **Packages** button brings up the [Packages dialog](#).

Units

The **Units** button the *Basic Package* dialog brings up the [Units dialog](#).

IBOUND

The **IBOUND** button of the *Global Options\Basic Package* dialog brings up the [Array Editor](#). The IBOUND array contains a value for each cell in the grid defining the type of the cell as constant head, inactive, or variable head.

Constant Head

A negative value indicates that the cell has a constant head. The value of the constant head is defined in the starting heads array.

Inactive

An IBOUND value of zero indicates that the cell is inactive (no-flow).

Variable Head

A positive IBOUND value indicates that the cell has a variable head (i.e., the head value will be computed as part of the simulation).

Editing the IBOUND Array

There are several ways to change the active/inactive status (positive vs. zero) of a cell before or after initializing the IBOUND array. One method is to directly edit the IBOUND array using the *IBOUND* dialog. Another method is to select the **Cell Attributes** command in the *MODFLOW* menu. In most cases, the most efficient method is to use the **Activate Cells in Coverage** command in the [Map module](#). This method uses a polygon to define the active and inactive regions.

The constant head cells are typically assigned or edited in one of three ways. One method is to directly edit the IBOUND array. Another method is to select a set of cells and use the [Cell Properties](#) dialog in the *MODFLOW* menu. The simplest method is to define the constant head zones using feature objects as part of a [conceptual model](#) in the [Map module](#).

Starting Heads

The starting head values are used as initial conditions for head for both steady state and transient simulations. The **Starting Heads** button on the left side of the *Basic Package* dialog is used to enter the values of the starting heads array. Selecting the **Starting Heads** button brings up the [MODFLOW Array Editor](#).

Top Elevation

The **Top Elevation** button brings up an [Array Editor](#) that allows editing of the top elevation of each layer. GMS requires that the top and bottom elevations for adjacent layers be the same. This means that when editing the bottom of one layer, move down to the next layer, and edit the top of that layer, the bottom of the previous layer will also be changed. Note that the top and bottom layer elevations must be entered regardless of the which layer data package (BCF, LPF, HUF) is chosen even though these values may not be used because of certain package options.

Bottom Elevation

The **Bottom Elevation** button brings up an *Array Editor* that allows editing the bottom elevation of each layer. Note that the top and bottom layer elevations must be entered regardless of the which layer data package (BCF, LPF, HUF) is chosen even though these values may not be used because of certain package options.



The Layer Confining Bed dialog.

Confining Beds

The *Layer Confining Beds* dialog, accessed from the *Global Options/Basic Package* dialog, allows selecting which layers will have a confining bed below them. The last layer in the grid may not have a confining bed.

Confining beds are most common in older models where the user was trying to conserve memory in solving the groundwater model. In general, it is recommended that users explicitly model all of the layers in the system instead of using confining beds. This feature is supported in GMS to make it possible for users to read in older models.

In the spreadsheet, the user may turn on the confining bed option for any of the layers except the last layer in the grid.

The **Confining Bed Elevations** button brings up the *Array Editor* that allows the user to edit the elevation of each layer.

GMG Package

The GMG package is one of the [solver packages](#) for MODFLOW supported by GMS. The GMG solver is an iterative solver based on a multi-grid approach.

Parameters include:

- *Inner convergence residual (RCLOSE)* – The algorithm computes the 12-norm of the residual and compares it against RCLOSE.
- *Maximum inner iterations (IITER)* – For each linear solution. The default is 100. Specify a smaller number for nonlinear problems to prevent an excessive number of inner iterations.
- *Outer convergence residual (HCLOSE)* – For nonlinear problems. After each linear solve (inner iteration), the maximum norm of the head change is compared against HCLOSE. Can be set to a large number for linear problems. Ignored if *Maximum outer iterations* is 1.
- *Maximum outer iterations (MAXITER)* – Also referred to as MXITER. For linear problems, set to 1. For nonlinear problems, set to a higher number though it is usually unnecessary to go above 100.
- *Damping parameter (DAMP)* – A value of 1.0 should be used for linear problems. For nonlinear problems, a value less than 1.0 but greater than 0.0 may be necessary to achieve convergence.
- *Damping option (IADAMP)* – Flag that controls adaptive damping. Contains the following options:
 - "(0) Constant"
 - "(1) Cooley adaptive"
 - "(2) RRR adaptive"
- *Maximum damping (DUP)*

- *Minimum damping (DLOW)*
- *Maximum head change (CHGLIMIT)*
- *Output flag (IOUTGMG)* – Flag that controls the output of the GMG solver. Values can be 0–4.
 - 0 = Only the solver inputs are printed.
 - 1 = For each linear solve, prints the number of PCG iterations, the value of the damping parameter, the 12-norm of the residual, and the maximum norm of the head change and its location (column, row, layer). At the end of a time/stress period, the total number of GMG calls, PCG iterations, and a running total of PCG iterations for all time/stress periods are printed.
 - 2 = The convergence history of the PCG iteration is printed, showing the 12-norm of the residual and the convergence factor for each iteration.
 - 3 = Same as 1 except the output is sent to the terminal instead of the output file.
 - 4 = Same as 2 except the output is sent to the terminal instead of the output file.
- *Maximum head output (IUNITMHC)*
- *Multi-grid preconditioner smoothing (ISM)* – Flag that controls the type of smoother used in the multi-grid preconditioner.
 - "(0) ILU smoothing" – This smoothing requires an additional vector on each multigrid level to store the pivots in the ILU factorization.
 - "(1) SGS smoothing" – Symmetric GaussSeidel (SGS) smoothing.
- *Multi-grid preconditioner coarsening (ISC)* – Flag that controls semi-coarsening in the multi-grid preconditioner.
 - "(0) Row, Col., Layer" – Coarsens all the rows, columns and layers.
 - "(1) Row, Col." – Coarsens all the rows and columns.
 - "(2) Col., Layer" – Coarsens all columns and layers.

- "(3) Row, Layer" – Coarsens all rows and layers.
- "(4) None" – No coarsening.
- *Relocation parameter (RELAX)* – Used to improve the spectral condition number of the ILU preconditioned system.

For more info on the GMG solver look at the following document:

Wilson, John D., and Richard L. Naff. *MODFLOW-2000, The US Geological Survey Modular Ground-Water Model—GMG Linear Equation Solver Package Documentation*. No. 2004-1261. 2004. [1]

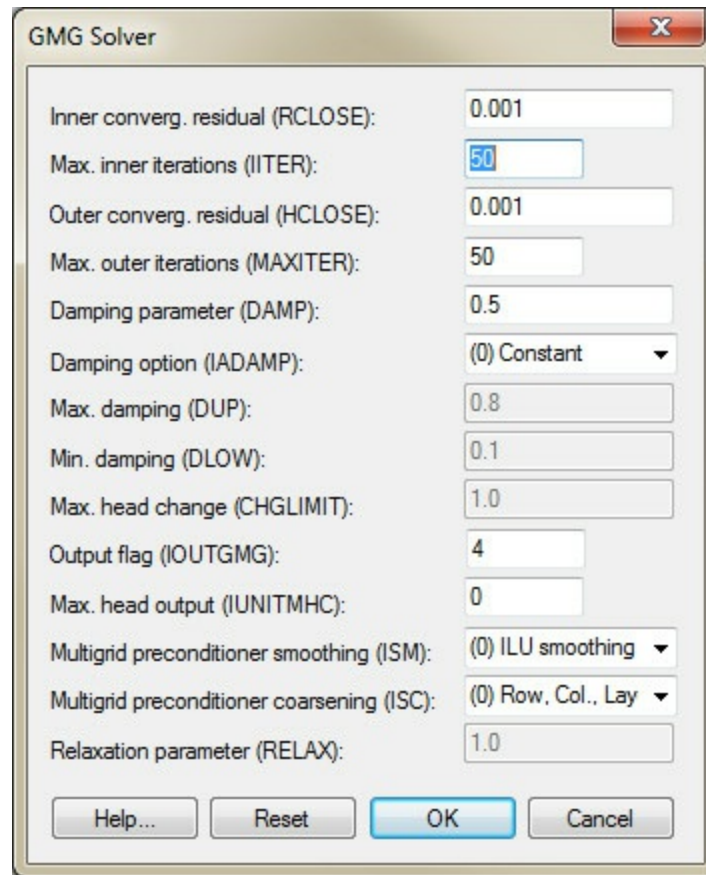

The MODFLOW GMG Solver package dialog.

GNC Package

The Ghost Node Correction (GNC) package is an optional package included in [MODFLOW-USG](#). It can be used to correct errors in the model that are created “when a line between two connected nodes does not bisect the shared face at a right angle”.

GMS provides an interface to the GNC package. The package can be turned on in the [MODFLOW Packages](#) dialog, accessible from the [MODFLOW Global/Basic Package](#) dialog. The package dialog can be accessed from the main [MODFLOW menu](#) or by right-clicking on the "☒ MODFLOW" item in the [Project Explorer](#).

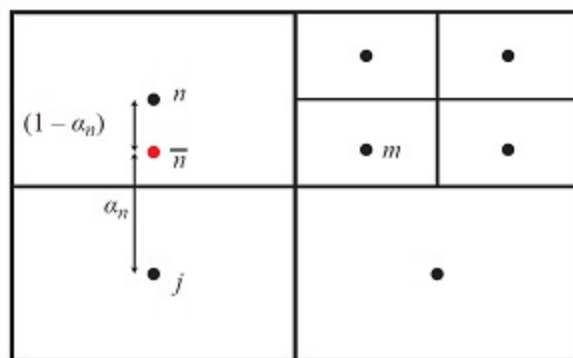

EXPLANATION

- ← Distance indicator
- Cell center
- Ghost node
- α_n Contributing fraction from node n

Ghost node conceptualization for nested grids.

GNC Package Dialog

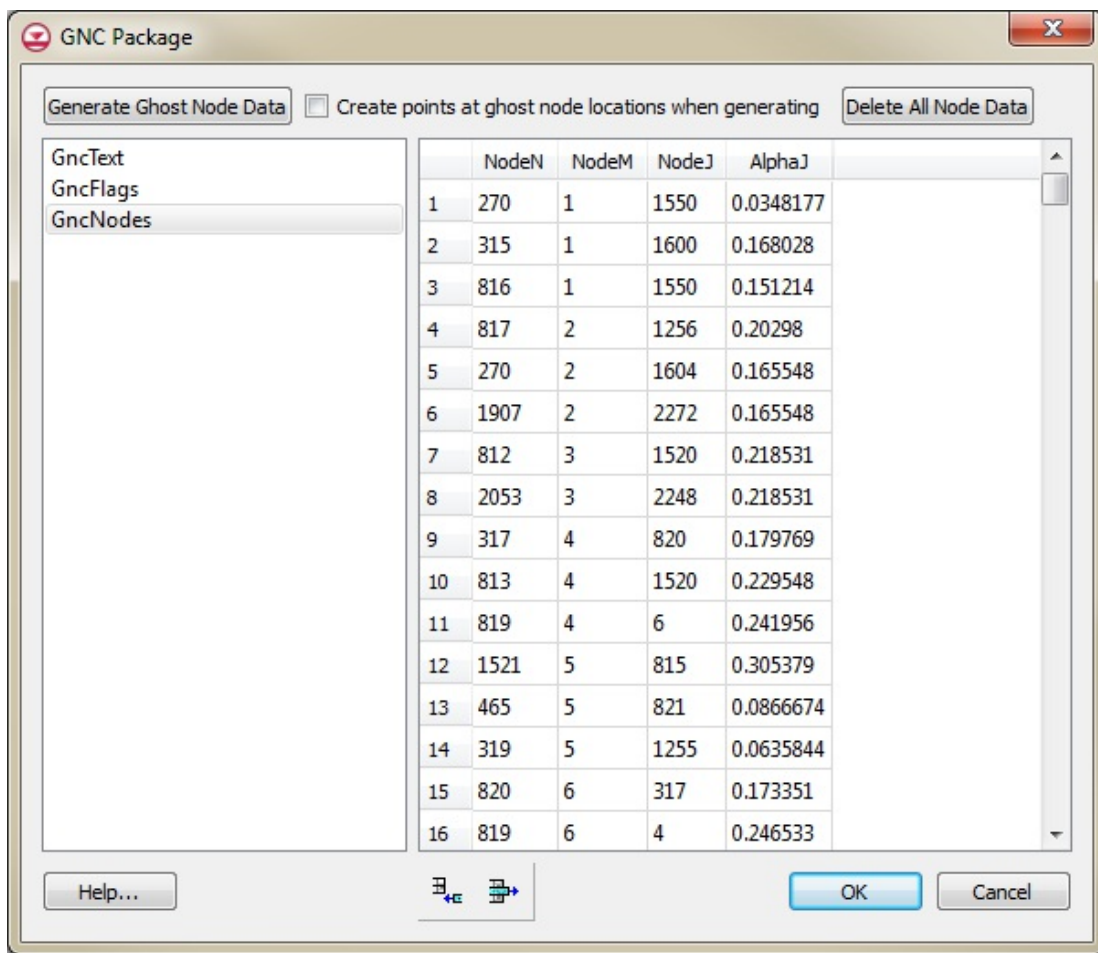

The GNC Package dialog

Enter the ghost node data by hand, or allow GMS to compute the data by clicking the **Generate Ghost Node Data** button. Clicking the button causes GMS to overwrite whatever is in the GncNodes table with the ghost node data calculated using an algorithm which calculates the locations of ghost nodes and computes the AlphaJ values based on the distances from ghost nodes to adjacent cells. Ghost node locations are calculated using the perpendicular bisector of the face between adjacent cells and its intersection with the lines connecting cell centers as illustrated in the figure below. The algorithm considers only the horizontal relationship of cells when locating ghost nodes. Thus, if the figure above is considered to be in plan view, the ghost node will be located as shown, but if it is considered to be in a front or side view with a subdivided layer on the right, no ghost node will be created.

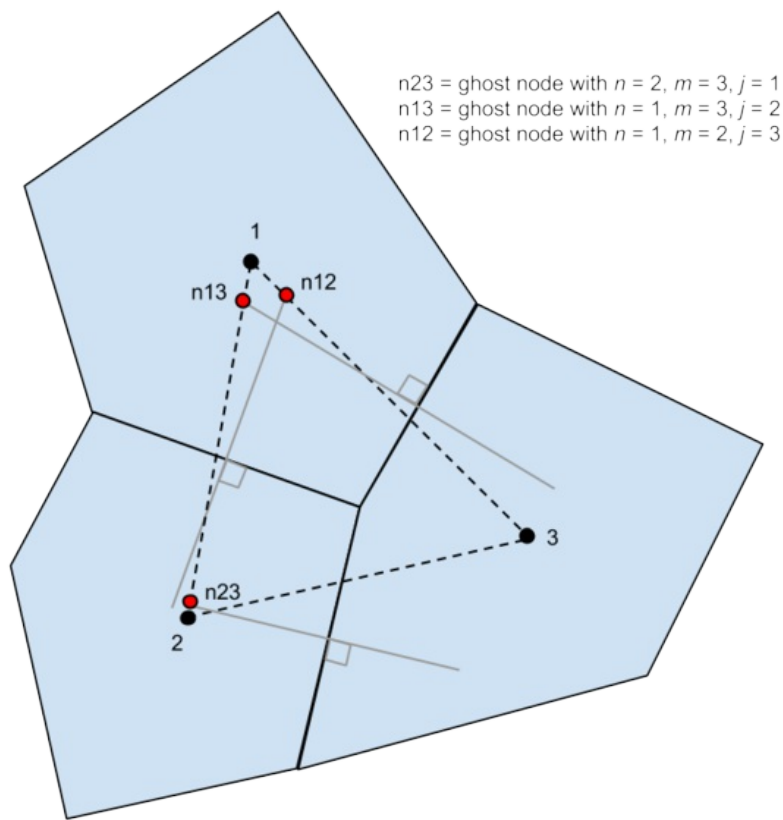

Ghost node general case algorithm.

If the *Create points at ghost node locations when generating* option is on, GMS will create a new **UGrid** called "Ghost Nodes" with points at the ghost node locations as calculated by GMS.

Unsupported Options

GMS does not currently support some GNC package options, including:

- Parameters
- IFALPHAn (always 0 in GMS)
- Integration with the CLN (Connected Linear Network) package to correct for errors due to the CLN cells not passing through the center of the groundwater grid cell

HFB Package

The Horizontal Flow Barrier (HFB) package is used to simulate the effect of sheet pile walls, slurry trenches, or other objects which act as a barrier (or partial barrier) to horizontal flow. Barriers are simulated in the HFB package by identifying cell boundaries which approximately coincide with the location of the barrier and assigning a hydraulic characteristic to each cell boundary. Each cell boundary represents a vertical face between two adjacent cells as shown in the following figure.

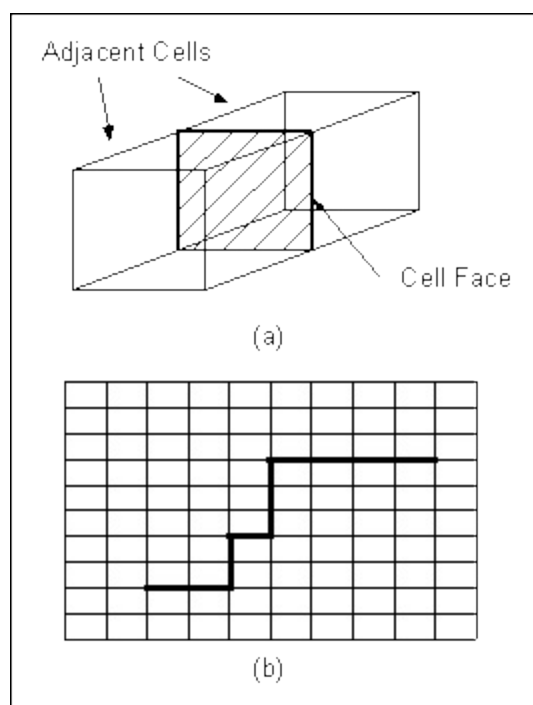

Cell boundary used to represent horizontal flow barrier: (a) Oblique view, (b) Plan view.

Hydraulic Characteristic

The original version of the HFB package required the input of the hydraulic characteristic either as barrier transmissivity divided by the width of the horizontal-flow barrier (for layer types 0 and 2 in BCF) or as barrier hydraulic conductivity divided by the width of the horizontal-flow barrier (for layer types 1 and 3 in BCF). In the current HFB package, the hydraulic characteristic is always the barrier hydraulic conductivity divided by the width of

the barrier, regardless of the layer type or flow package (BCF or LPF) used; thus, layer thickness is always used in calculating the contribution to the conductance terms. The HFB package uses cell elevations specified in the discretization file to calculate cell thickness. Cell thickness is head dependent for layer types 1 and 3 in the BCF Package and for convertible layers in the Layer-Property Flow package. (taken from MODFLOW 2000 documentation)

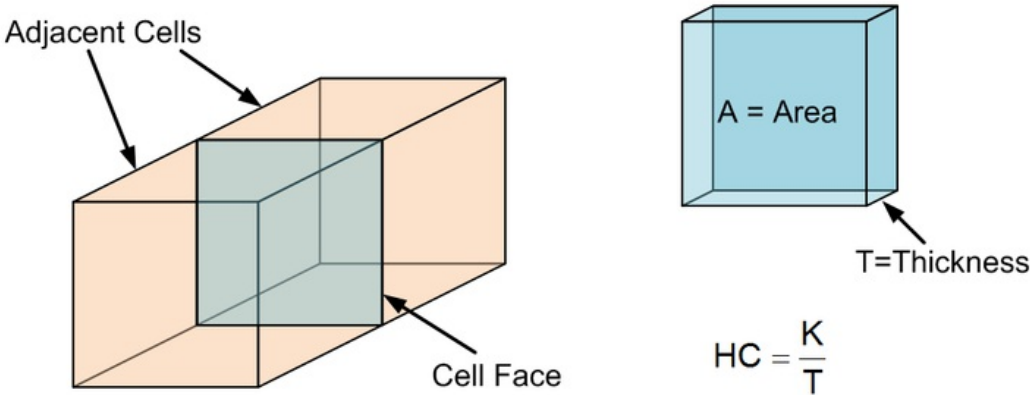

Conceptual representation of HFB and hydraulic characteristic

Defining Barriers

Barriers are defined in one of two ways: (1) they can be defined using a set of arcs in the [Map module](#) or (2) they can be defined one cell boundary at a time using the **Toggle Barrier** command in the 3D grid module.

Using the Map Module

In most cases, the simplest method is to create one or more Horizontal Flow Barrier arcs in the Map module corresponding to the barriers and let GMS automatically find the closest sequence of cell boundaries and mark them as barriers.

Using the Toggle Barrier Command

Horizontal flow barriers can also be defined one at a time by selecting two adjacent cells and selecting the *MODFLOW* | **Toggle Barrier** menu command. This brings up a dialog that

can be used to mark the boundary between the two selected cells as a barrier and to enter a hydraulic characteristic for the barrier. This same command can be used to delete a barrier between two cells.

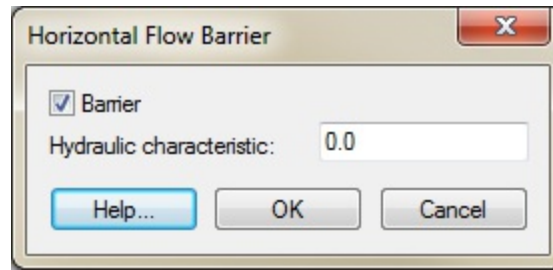

The Horizontal Flow Barrier dialog

HFB Package Dialog

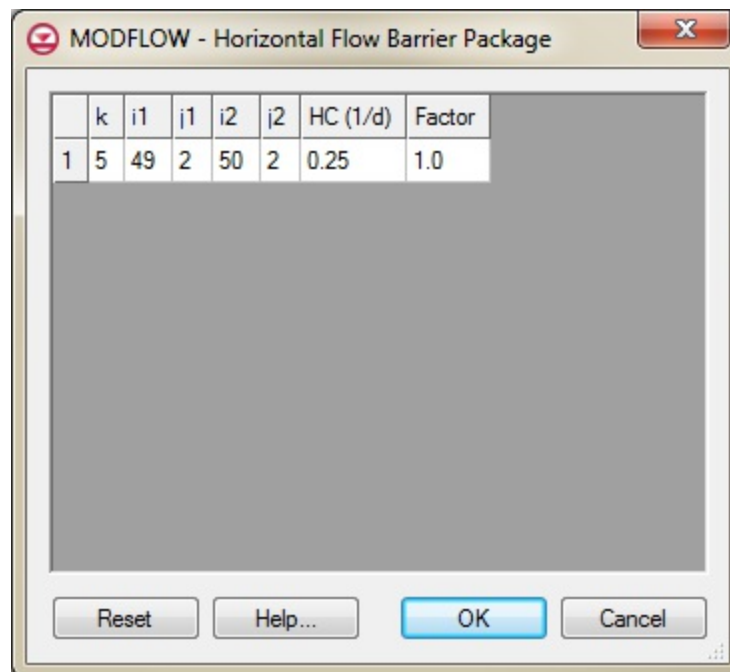

The MODFLOW – Horizontal Flow Barrier Package dialog

Regardless of which method is used to define the barriers, an existing set of barriers can be viewed and edited using the **HFB Package** command in the *MODFLOW* menu. This command brings up the *MODFLOW – Horizontal Flow Barrier Package* dialog. This dialog can be used to edit the location and hydraulic characteristic of each of the currently defined barriers.

Spreadsheet

For cells where horizontal flow barriers have been assigned, the hydraulic characteristic assigned to each cell is displayed in the spreadsheet portion at the lower part of the dialog.

Reset

The **Reset** button can be used to delete all barriers.

HUF Package

The Hydrogeologic-Unit Flow (HUF) package is an alternative to the [BCF](#) and [LPF](#) packages. It allows the user to define the vertical elevations of the hydrogeology independent of the 3D grid as shown in the figures below. Notice in the figures below that the second grid layer has more than one hydrogeologic unit associated with it.

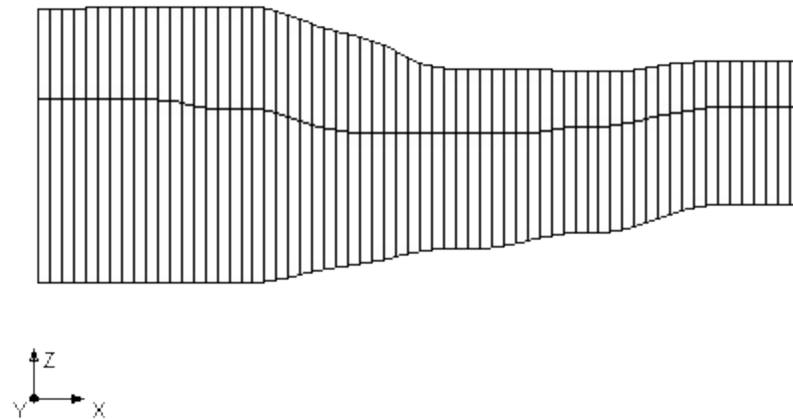

Side view of MODFLOW grid

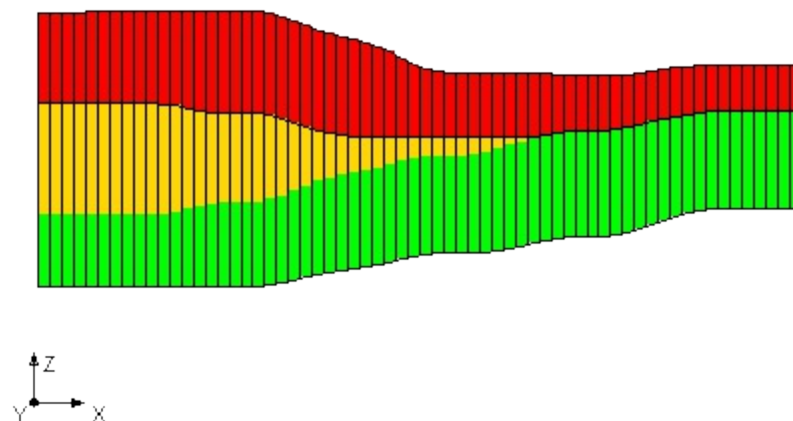

HUF units displayed in MODFLOW grid

With the HUF package, the user then defines the top and thickness of each of the

hydrogeologic units. A material is associated with each unit and the hydraulic properties (HK, VK...) are assigned to the material. The top and thickness arrays can be automatically generated from solids using the **Solids** → **HUF** command from the *Solids* menu or from boreholes with the **Horizons** → **HUF** command in the *Boreholes* menu.

Another feature in GMS that incorporates the HUF package is the ability to use TPROGS to [generate HUF data](#).

Once the HUF package has been chosen using the *Packages* dialog, the *HUF Package* dialog can be accessed through the **HUF package** command in the *MODFLOW* menu. The following options are available in the *HUF Package* dialog.

Layer

This field displays the current layer. Selecting any of the input array buttons will display the corresponding layer initially. For multiple layer models, this field can be incremented or decremented to show other layers.

Layer type

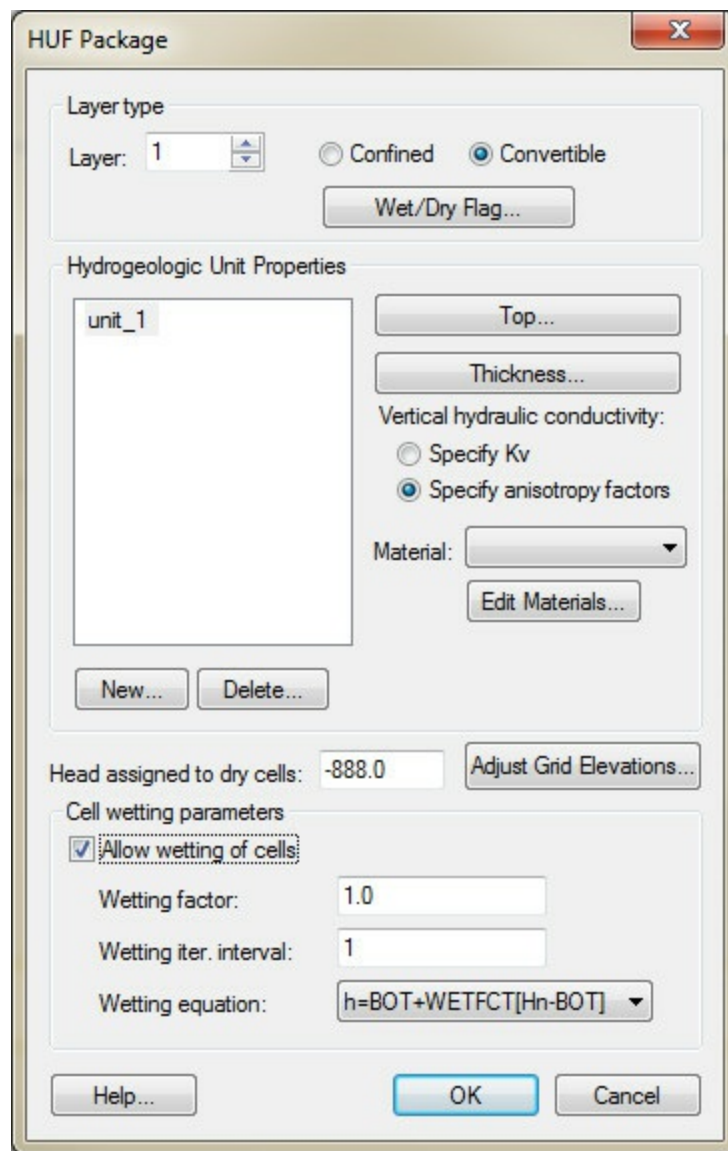

The MODFLOW HUF Package dialog.

This radio group selects the layer type for the current layer. By default, all layers are convertible. Only one layer type can be assigned to each grid layer.

Hydrogeologic Unit Properties

The window lists the names of the currently defined units. The **Top and Thickness** buttons bring up the [MODFLOW Array Editor](#). For each hydrogeologic unit the user can specify if vertical hydraulic conductivity (VK) or vertical anisotropy (VANI) will be used. The material selection box shows the material the is assigned to the unit. The material properties (HK, VK...) are edited by selecting the **Edit Materials** button.

Vertical hydraulic conductivity

The HUF package has the option to enter vertical hydraulic conductivity values as either actual hydraulic conductivity values or as anisotropy factors dependant on horizontal hydraulic conductivity. These options are only available for multi-layer models.

Head Assigned to Dry Cells

This is the value that MODFLOW will give to cells with a head level below the bottom elevation of the cell (dry cell). When reading in a solution, GMS will mark cells with this value with a dry cell symbol.

Cell Rewetting Parameters

If wetting of cells is allowed, a wetting factor, wetting iteration interval, and wetting equation must be specified.

LAK Package

The Lake (LAK) package is a more sophisticated alternative to the typical approach of using the General Head package to simulate the effect of lakes and reservoirs on an aquifer. Comparing the Lake package to the GHB package is similar to comparing the River package to the Stream package. With the GHB package, the user defines the stage. With the Lake package, the stage is computed automatically based on the water budget. The water budget is a function of inflow, outflow, recharge, evaporation, etc. The storage capacity of the lake is determined automatically based on the lake geometry. Some of the cells defining the lake are allowed to go dry if the lake stage drops sufficiently.

The lake is also assumed to have lakebed sediments which affect the flow between the aquifer and the lake. The effect of the lakebed sediments is represented with a leakance term which includes the thickness and the hydraulic conductivity.

The Lake package includes an option that allows one to simulate "sublakes". This option makes it possible for the lake to partition into smaller, separated lakes as the lake stage drops.

The Theta term offers a choice between an explicit solution at 0.0, a semi-implicit solution between 0.0 and 1.0, or an implicit solution at 1.0

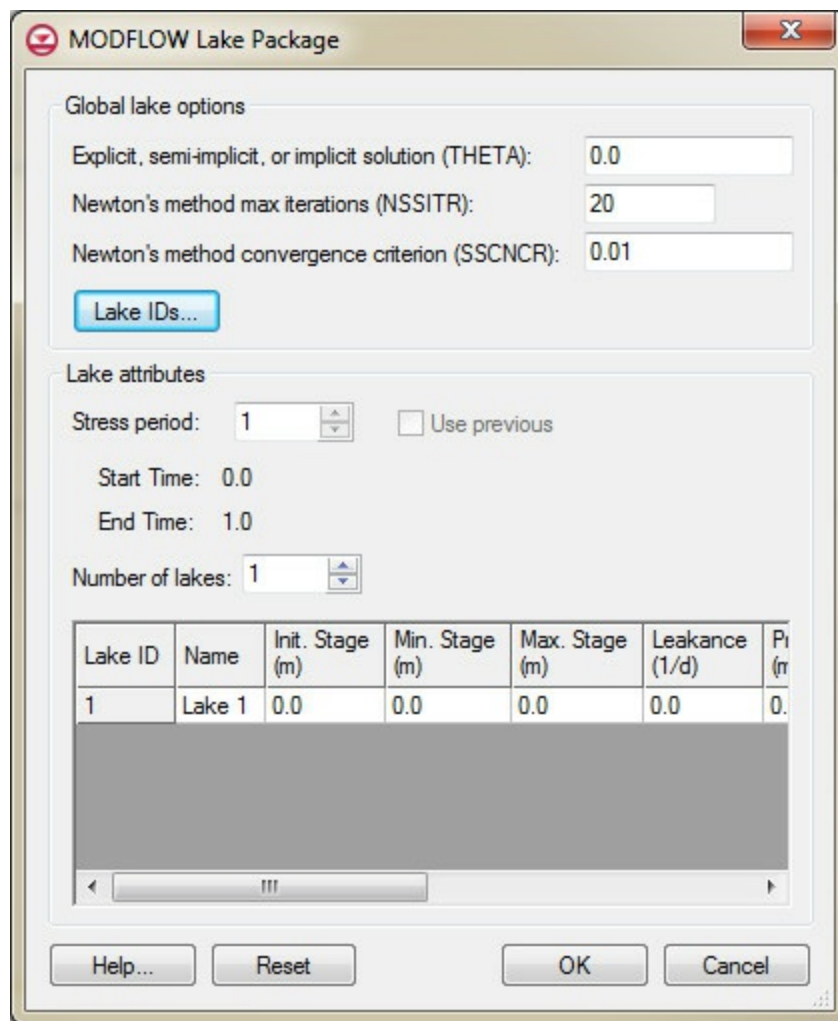

The MODFLOW Lake Package dialog.

Terms

- *Leakance* – Represents the lakebed leakance. This is a function of hydraulic conductivity and lakebed thickness
- *Bathymetry* – A reference to a TIN from which the bathymetric elevations are derived.
- *Sill Elev* – The sill elevation at which the sublake begins to drain into the parent lake.
- *Withdrawal* – The volumetric rate, or flux, of water removal from a lake by means other than rainfall, evaporation, surface outflow, or ground-water seepage.

Adjust Cell Elev.

Lake polygons in a [conceptual model](#) include an option called *Adjust Cell Elev.* This option often results in thin cells and instability and should generally be avoided. Here's how it works. GMS interpolates a bathymetric elevation from the appropriate TIN and finds the cell where the top of the cell is above the bathymetric elevation and the bottom of the cell is below. After finding the intersecting cell, all cells above the point in question are marked as inactive (IBOUND = 0) and assigned with the appropriate lake ID. For the cell that intersects the bottom of the lake, the way the cell is handled depends on what layer it is in. If the cell is in the top layer, it is made inactive, marked as part of the lake, and the bottom elevation of the cell is adjusted to match the lake bottom. If the cell is in one of the lower layers, GMS first determines if the lake bottom is closer to the top of the cell or the bottom of the cell. If the lake bottom is closer to the top of the cell, the top elevation for the cell is adjusted to match the bottom of the lake and the cell is left as active and NOT marked as being in the interior of the lake. If the lake bottom is closer to the bottom of the cell, the bottom elevation of the cell is adjusted to match the lake bottom and the cell is marked as both inactive and inside of the lake.

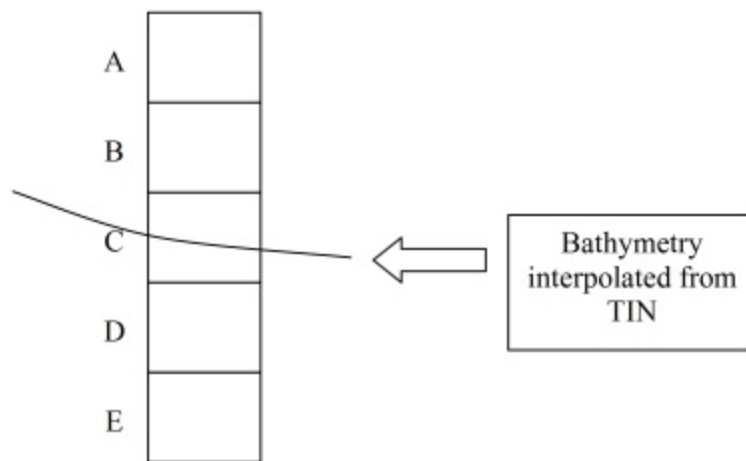

Lake bathymetry

LMG Package

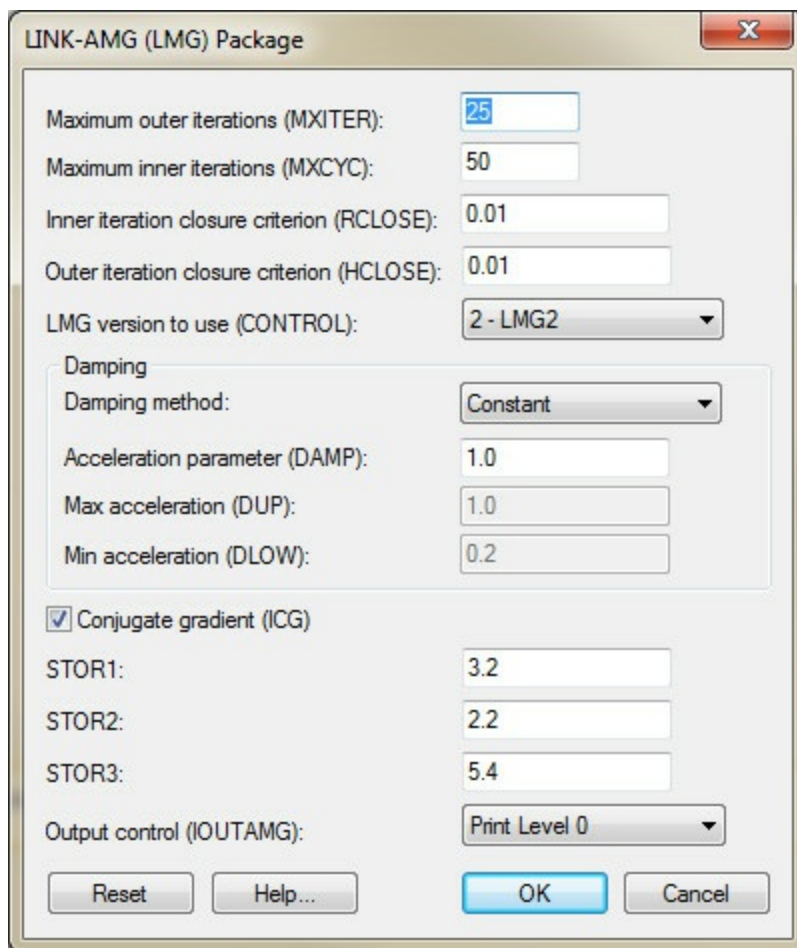

The MODFLOW LINK-AMG (LMG) Package dialog.

The MODFLOW Link-AMG (Algebraic Multi-Grid), or LMG (Link Multi-Grid), package solver is an interface linking the SAMG (Systems Algebraic Multi-Grid) library to MODFLOW. The LMG3 package offers some improvements over the LMG1 package for certain types of problems, and is backward compatible with LMG1 input files. For non-linear problems and simulations which use several time steps, subsequent matrices to be solved for often change only slightly in their algebraic properties. In these cases the LMG3 solver can accelerate the overall simulation run enormously. Using SAMG the user can run a specific GMS MODFLOW executable (mf2k5_..._parallel.exe) with parallel processing on a single machine (though not across multiple machines on a network).

The [LMG1 package](#) is only supported in GMS versions prior to 8.0.

MXITER. Maximum outer iterations

This value is the maximum iterations, or calls to the solver. For linear problems, this value can be 2. For non linear problems, this values should be larger, but generally less than 50.

MXCYC. Maximum inner iterations

This value is the maximum number of iterations per call to the solver. The default value is 50, and this is sufficient for most problems.

RCLOSE. Inner iteration closure criterion

Same as RCLOSE for the GMG solver package. The PCG algorithm computes the l_2 norm of the residual and compares it against RCLOSE. In LMG1 this was called budget closure criterion. When the scaled norm of the matrix equations is less than this value then the solver iteration stops.

HCLOSE. Outer iteration closure criterion

Head change convergence criterion for nonlinear problems. After each linear solve (inner iteration), the maximum norm of the head change is compared against HCLOSE.

CONTROL. LMG version to use

This variable allows the user to select either LMG1 or LMG2 version of the LMG solver.

Damping method

Three different damping methods are available: constant, Adaptive damping using the Cooley method, or Adaptive RRR damping using the relative reduced residual. Refer to the official package documentation for more explanation on the different damping methods.

DAMP. Acceleration Parameter

This value is used if the acceleration method is set to constant. Usually, this value is 1.0, but for some problems lower values may help achieve convergence.

DUP. Max Acceleration

This is the maximum damping value when using the adaptive damping with relative reduced residual.

DLOW. Min Acceleration

This is the minimum damping value when using the adaptive damping with relative reduced residual.

Conjugate Gradient

Controls whether the conjugate gradient method is used to accelerate the solver. By default this option is on.

Stor1, Stor2, Stor3

These values are ignored in LMG2. In LMG1, these variables are used to control the amount of memory storage used by the solver. The defaults rarely need to be changed.

IOUTAMG. Output control

This controls the information printed to the SAMG output file while the solver is running.

Reset

This button will change all options to the default state.

External Links

- [LMG/SAMG Manual for MODFLOW-2000](#)
- [MODFLOW-2005 LMG/SAMG Page](#)
- [Additional information](#)

LPF Package

The Layer-Property Flow (LPF) package is an alternative to the [BCF](#) and [HUF](#) packages and is similar to the "true layer" option used with the BCF package in version 3.1. With MODFLOW 2000, the layer elevations (top and bottom) are defined as input to the Global Process (using the [Global Options dialog](#)), regardless of which flow package is being used. With the LPF package, define the horizontal (K_h or HK) and vertical hydraulic conductivity (K_v or VK) for each layer. MODFLOW then computes the cell by cell conductances using the K values and the layer geometry.

Other noteworthy features include the ability to enter horizontal anisotropy values on a cell by cell basis. There is also an option to specify vertical anisotropy factors rather than vertical hydraulic conductivity values. This option is particularly useful when performing automated parameter estimation since it ties the K_v to K_h and eliminates the need to define K_v as an independent parameter.

Another feature of the LPF package relative to the BCF package is that there are now only two layer types: confined and convertible. A convertible layer is similar to the LAYCON = 2 and LAYCON = 3 types in the BCF package. The layer can be either confined or unconfined depending on the elevation of the computed water table.

Once the LPF package has been chosen using the packages dialog, the *LPF package* dialog can be accessed through the **LPF – Layer Property Flow...** command in the *MODFLOW* menu.

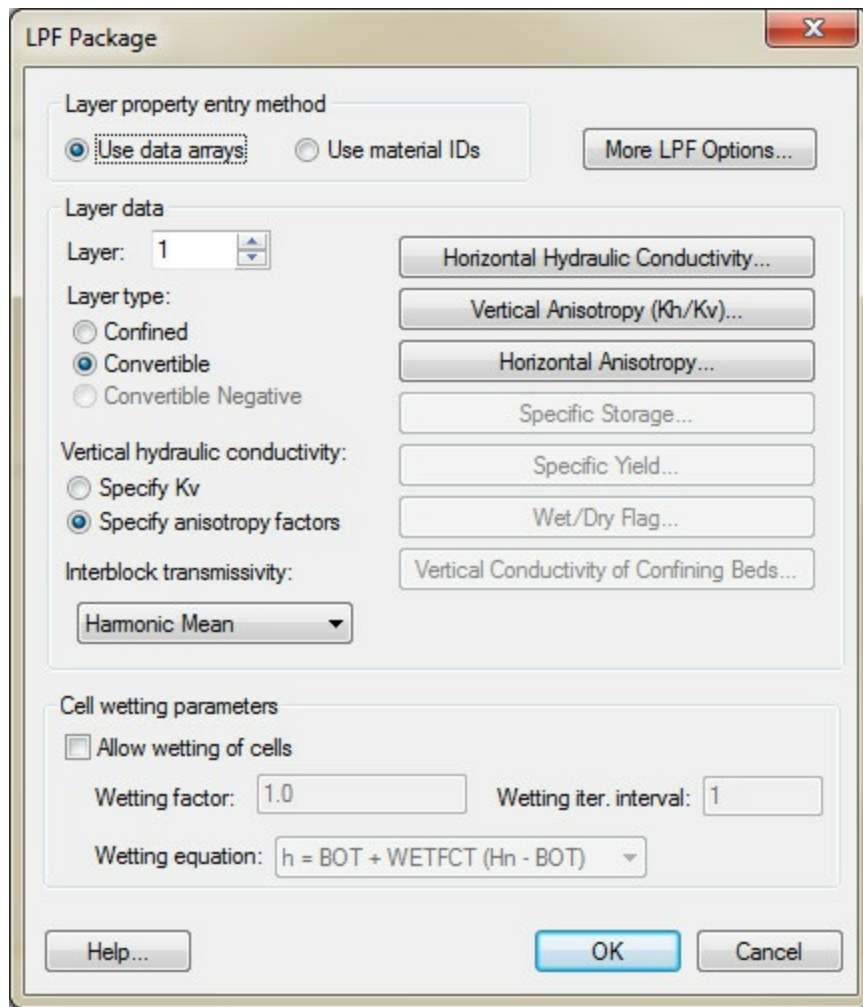

The LPF Package dialog.

Use data arrays

This option allows entering conductivities on a layer-by-layer basis. When this option is chosen, the **Horizontal Hyd. Conductivity...**, **Vertical Hyd. Conductivity**, **Specific Storage**, etc. buttons will be available.

Use material ids

This options uses material sets in the place of property arrays. Property values are entered on a material-by-material basis. When MODFLOW files are saved, GMS internally replaces the correct values from the materials to the property arrays. When this option is chose, the property array buttons are replaced with the **Material Properties** and **Material IDs** buttons.

Layer

This field displays the current layer. Selecting any of the input array buttons will display the corresponding layer initially. For multiple layer models, this field can be incremented or decremented to show other layers.

Layer type

This radio group selects the layer type for the current layer. By default, all layers are convertible (where the layer can be either confined or unconfined depending on the elevation of the computed water table). Here layer type can be changed to confined. Only one layer type can be assigned to each grid layer.

Vertical hydraulic conductivity

The LPF package has the option to enter vertical hydraulic conductivity values as either actual hydraulic conductivity values or as anisotropy factors dependant on horizontal hydraulic conductivity. Vertical anisotropy (VKA) "is the ratio of horizontal to vertical hydraulic conductivity. In this case, HK is divided by VKA to obtain VK, and values of VKA typically are greater than or equal to 1.0." These options are only available for multi-layer models.

Interblock transmissivity

The method used for computing interblock transmissivity is specified using the pull-down list in the middle right portion of the *LPF Package* dialog.

Layer Data Arrays

The seven buttons in the middle-right portion of the dialog represent layer data arrays such as elevations and hydraulic conductivity. Each of the seven buttons brings up the [MODFLOW Array Editor](#). Not all of the data arrays need to be specified for each layer. Some arrays such as [Specific Storage](#) and [Specific Yield](#) are only required for transient models.

Cell Wetting Parameters

If re-wetting of cells (when cells that went dry during the simulation later have head) is

allowed, a wetting factor, wetting iteration interval, and wetting equation must be specified.

More LPF Options

Clicking on the **More LPF Options** button brings up the *LPF Package Options* dialog where it is possible to remove vertical leakance correction or set a head value for dry cells.

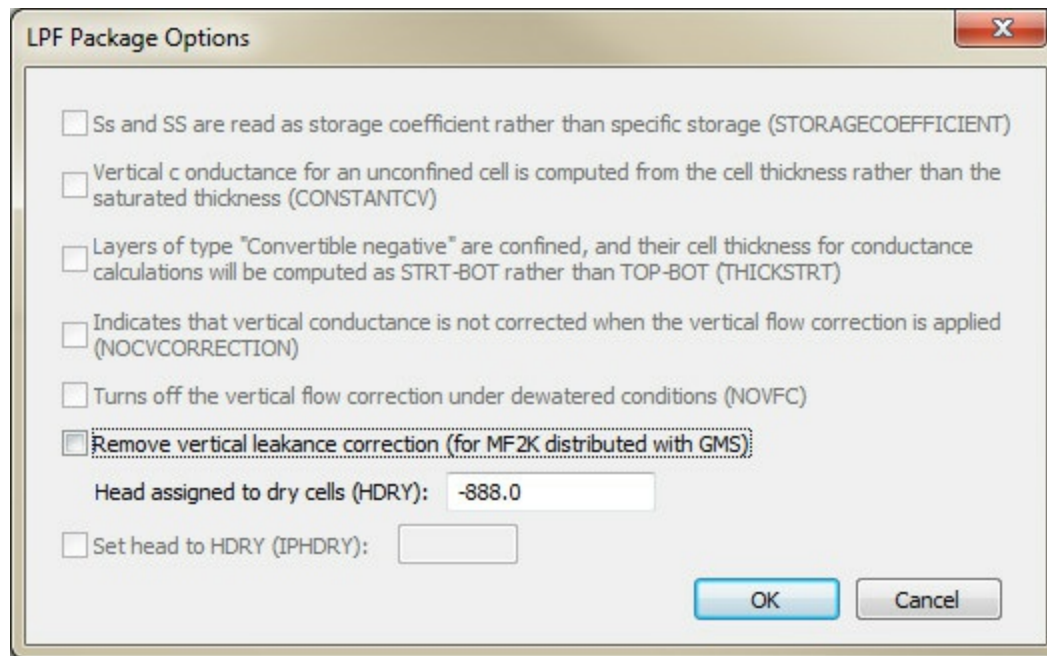

The LPF Package Options dialog.

Remove vertical leakance correction

This is the value that MODFLOW will give to cells with a head level below the bottom elevation of the cell (dry cell). When reading in a solution, GMS will mark cells with this value with a dry cell symbol. The Layer Property Flow Package of MODFLOW-2000 was modified by A.W. Harbaugh (U.S. Geological Survey, written commun., 2002) to remove the vertical leakage correction for conditions in which a partially saturated cell is immediately below a fully or partially saturated cell (Harbaugh and others, 2000, p. 31-33). The vertical leakage correction simulates perched conditions within an aquifer system. However, perched conditions are not known to be widespread on a basin scale. The vertical leakage correction adds an additional nonlinear term to the model (A.W. Harbaugh, U.S. Geological Survey, written commun., 2002), which resulted in several of the numerical solvers (SIP (strongly implicit procedures), SOR (slice-successive overrelaxation), and PCG (Hill, 1990;

Harbaugh and others, 2000) not coming to a solution and the LMG (link-algebraic multigrid; Mehl and Hill,2001) solver providing unacceptable volumetric budget errors (wrir02-4200.pdf) . Thus in the LPF package there is the option to turn off the vertical leakance correction to account for these factors. After turning on the *Remove Vertical Leakance Correction* toggle, GMS then uses the **NOCVCORRECTION** option that is found in MODFLOW2005 to remove vertical leakance corrections.

Head Assigned to Dry Cells

This is the value that MODFLOW will give to cells with a head level below the bottom elevation of the cell (dry cell). When reading in a solution, GMS will mark cells with this value with a dry cell symbol.

MNW1 Package

The Multi-Node Well (MNW1) package was developed to more accurately model wells that are completed in multiple aquifers or in a single heterogeneous aquifer, partially penetrating wells, and horizontal wells that can be affected by the effects of dynamic changes in the distribution of pumping or intraborehole flow that can significantly alter groundwater flow. A more recent revision of the MNW package is available in the [MNW2 package](#). A MODFLOW model can not use both the MNW1 and MNW2 packages, it must use one or the other.

MNW1 boundary conditions can be added to selected cells using the [Point Sources/Sinks](#) command in the *MODFLOW* menu. MNW1 points can also be defined using the [conceptual model approach](#) in the [map module](#).

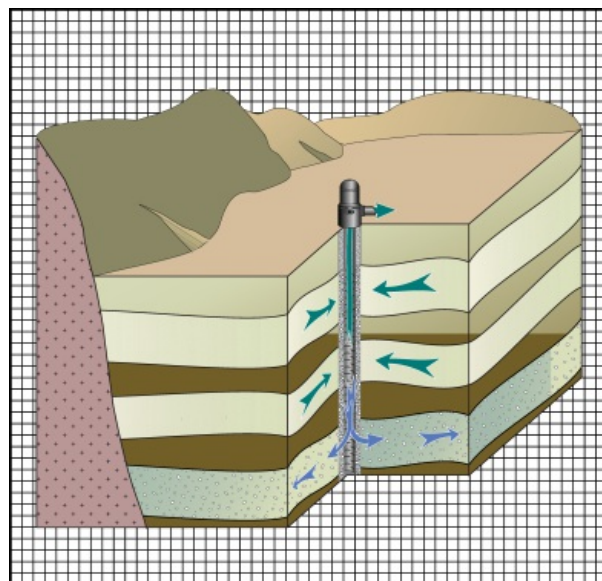
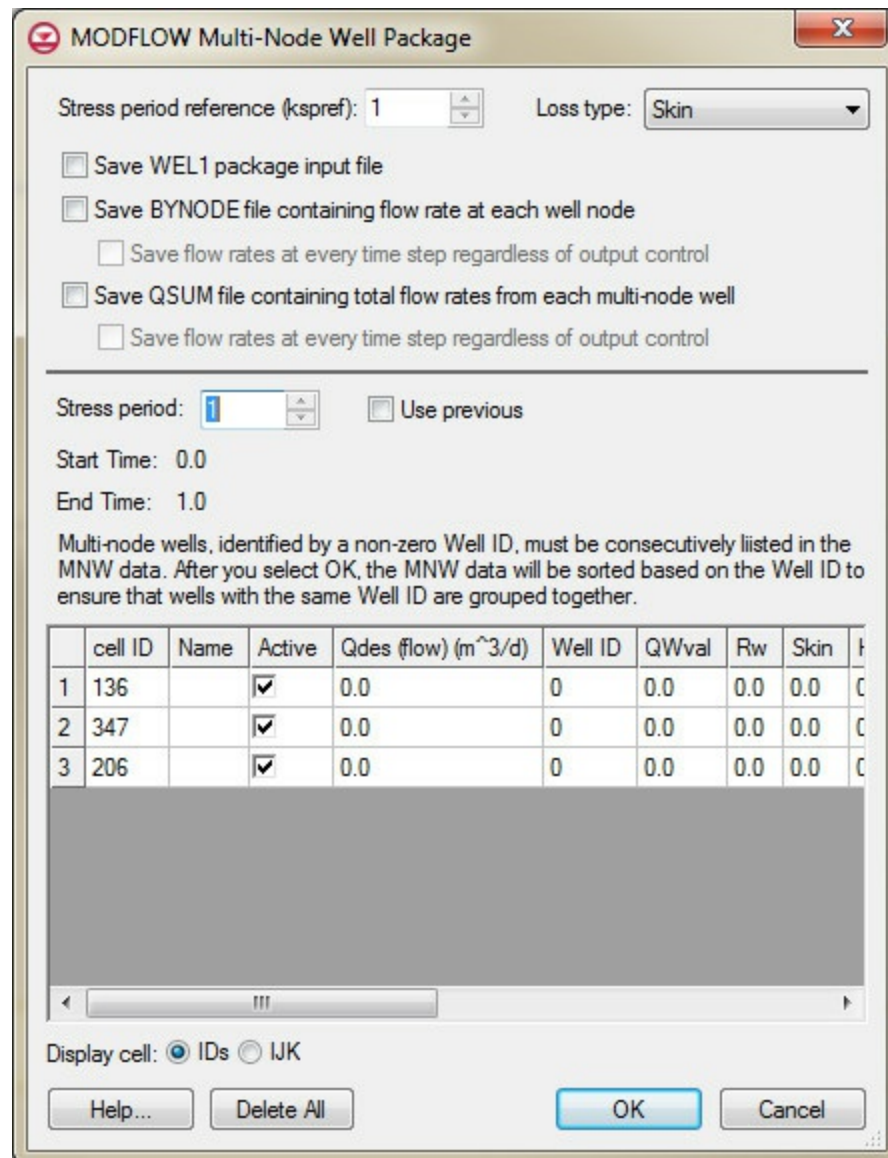

Illustration of MNW package

Conceptual model

MNW1 wells can be modeled using points in a [conceptual model](#). The user can specify the

various MNW1 properties associated with points in a coverage. In addition, a multi-node MNW1 boundary condition can be created using the conceptual model approach. The easiest way to create a multi-node MNW1 boundary condition is to define a well screen associated with the MNW1 point that crosses multiple layers of the MODFLOW grid. Another method for creating a multi-node MNW1 boundary condition is to specify a common "Well ID" to group different points together. Thus, multiple points in the same or different coverages can be used to create multi-node MNW1 boundary conditions.



The MODFLOW Multi-Node Well Package dialog.

Multi-Node Well package dialog

The *Multi-Node Well (MNW1) package* dialog allows the user to edit the location and the input values associated with each MNW boundary condition. MNW1 boundary conditions cannot be created or deleted from this dialog. They can be created and deleted via the **Map** → **MODFLOW** command, or by using the [MODFLOW Source/Sink dialog](#).

The upper section of the dialog controls global options for the package. The spreadsheet in the lower section of the dialog controls the boundary conditions that vary with each stress period. The user is referred to the MNW1 documentation for a full explanation of each of the inputs to the MNW1 boundary conditions. GMS has added the *Name*, *Active*, and *Well ID* fields. *Name* is a label used to identify a boundary condition. *Active* is a flag used to determine if the boundary condition is used during a particular stress period. The *Well ID* field is used to identify multi-node wells.

MNW2 Package

The Multi-Node Well (MNW2) package is an updated revision of the MNW package meant to replace the [MNW1 package](#). It includes modifications to better model partially penetrating wells, non-vertical wells, and includes the ability to specify a pump performance curve. The MNW package was developed to more accurately model wells spanning multiple aquifers or in a single heterogeneous aquifer, partially penetrating wells, and horizontal wells that can be affected by the effects of dynamic changes in the distribution of pumping or intraborehole flow that can significantly alter groundwater flow. A MODFLOW model can not use both the MNW1 and MNW2 packages, it must use one or the other. A detailed description of the MNW2 input is available at [the USGS website](#).

MNW2 boundary conditions can be directly added via the Multi-Node Well (MNW2) package dialog. Boundary conditions can also be added to selected cells using the **Point Sources/Sinks** command in the *MODFLOW* menu. For a [conceptual model](#) MNW2 points can be defined in the [map module](#).

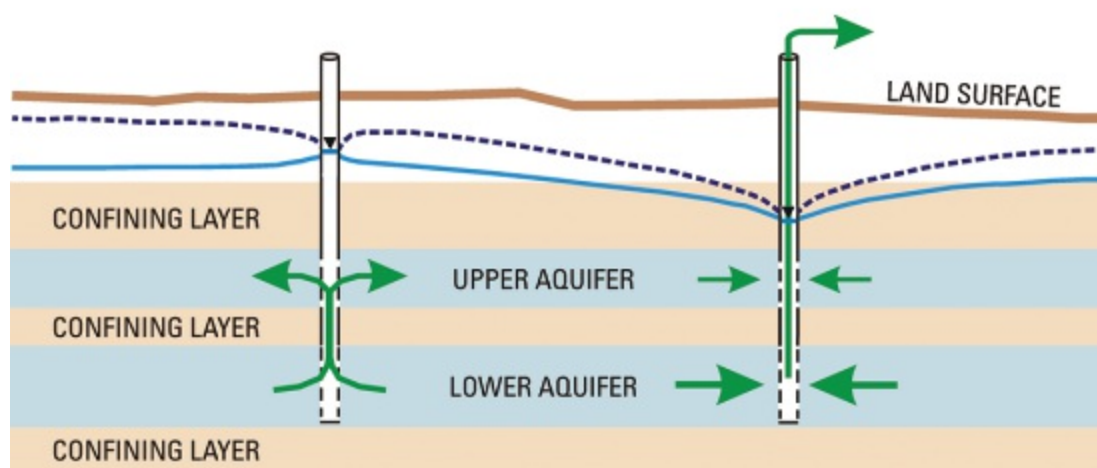
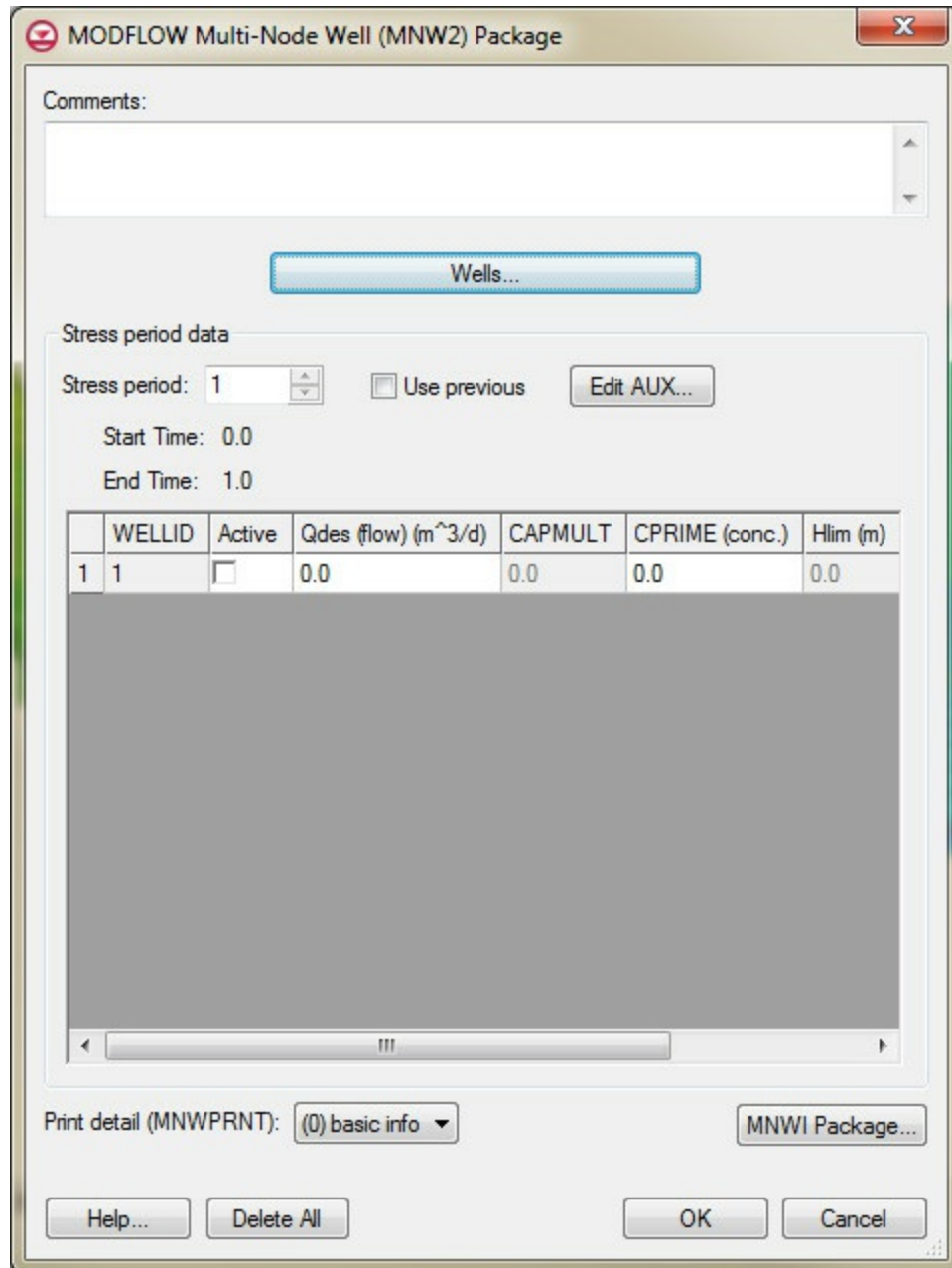

Illustration of MNW2 package

Conceptual Model

An MNW2 well can be added to a [conceptual model](#) by creating an MNW2 point. The

geometry of the well screen can be set using the **Use screen** attribute for a single screen, or for multiple screens the geometry can be set using the **Boreline** attribute button. If neither one is set, the generated well nodes include the grid layers specified for the coverage by its default layer range.



The MODFLOW Multi-Node Well (MNW2) Package dialog.

Multi-Node Well (MNW2) Package Dialog

MNW2 wells can be edited in the *Multi-Node Well (MNW2) Package* dialog. The main

dialog allows editing stress period data for wells. The stress period field shows the current stress period and allows you to cycle through stress periods and view the well properties for each stress period in the spreadsheet below. MNW2 AUX fields can be added and removed by clicking on the **Edit AUX...** button. The values are displayed in the spreadsheet. Controls to edit the print detail (MNWPRNT) and the MNWI package values are available below the spreadsheet. Wells can be added, edited and removed by clicking on the **Wells...** button to bring up the *MNW2 Wells* dialog.

MNW2 Wells Dialog

The *MNW2 Wells* dialog allows wells to be added, removed, and edited. It consists of two spreadsheets. The top spreadsheet lists the table of MNW2 wells. When a well in the top spreadsheet is clicked on, the nodes for the well are listed in the bottom spreadsheet. Nodes can be added and removed by changing the NNODES column in the wells spreadsheet.

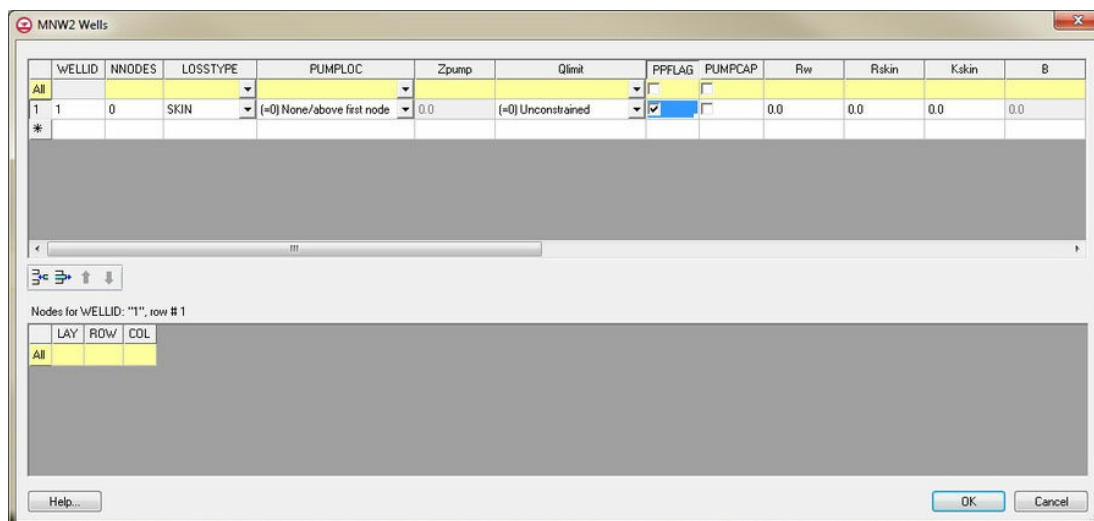

The MNW2 Wells dialog.

Sources/Sinks Dialog

An MNW2 well can be added or edited for a selected cell using the **Sources/Sinks** menu item under the *MODFLOW* menu. The well info can be edited from the *Sources/Sinks*

dialog by clicking on the  button in the *Edit* column.

NWT Package

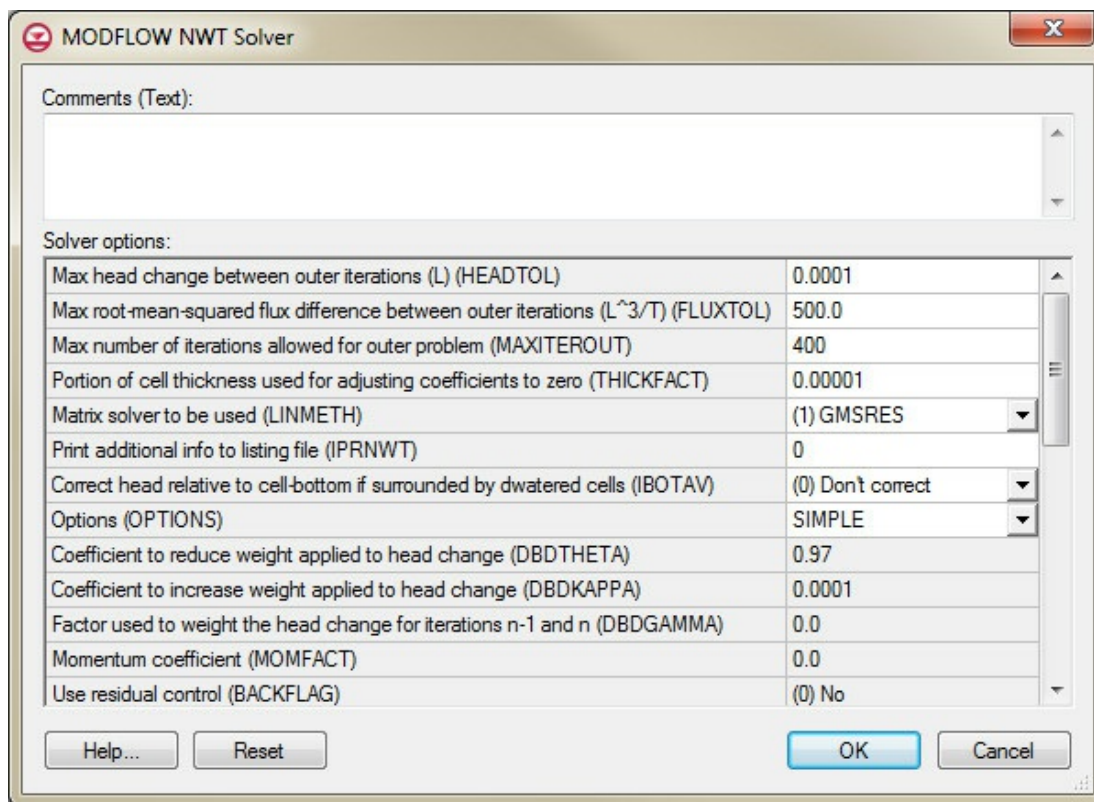

Example of the MODFLOW NWT Solver dialog.

The Newton package (NWT) is one of the solvers available in MODFLOW-NWT. The NWT package is only used with the [UPW Package](#). Using the NWT solver requires twice the memory of other MODFLOW solvers because using the Newton method results in an asymmetric matrix. Because of the asymmetric matrix a different matrix solver must be used. The NWT package provides an option to use one of two matrix solvers: a generalized-minimum-residual (GMRES) solver and an Orthomin/stabilized conjugate-gradient solver called χ MD (chi-MD).

General Options

- *Comments (Text)* – Allows up to 199 characters.
- *Max head change between outer iterations (L)(HEADTOL)* – For solution of the

nonlinear problem.

- *Max root-mean-squared flux difference between outer iterations (L^3/T) (FLUXTOL)* – For solution of the nonlinear problem.
- *Max number of iterations allowed for outer problem (MAXITEROUT)* – For solution of the nonlinear problem.
- *Portion of cell thickness used for adjusting coefficients to zero (THICKFACT)* – The portion of the cell thickness (length) used for smoothly adjusting storage and conductance coefficients to zero.
- *Matrix solver to be used (LINMETH)* – A flag that determines which matrix solver will be used.
 - (1) GMRES
 - (2) χ MD
- *Print additional info to listing file (IPRNWT)* – A flag that indicates whether additional information about solver convergence will be printed to the main listing file
- *Correct head relative to cell-bottom if surrounded by dewatered cells (IBOTAV)* – A flag that indicates whether corrections will be made to groundwater head relative to the cell-bottom altitude if the cell is surrounded by dewatered cells.
 - (0) Don't correct
 - (1) Correct
- *Options (OPTIONS)* – Includes the following options:
 - SPECIFIED – Indicates that the optional solver input values will be entered by the user.
 - SIMPLE – Indicates that default solver input values will be defined that work well for nearly linear models.
 - MODERATE – Indicates that default solver input values will be defined that work well for moderately nonlinear models.

- COMPLEX – Indicates that default solver input values will be defined that work well for highly nonlinear models.
- CONTINUE – Without this the model will stop after convergence failure.

General Specified Options

- *Coefficient to reduce weight applied to head change (DBDTHETA)* – Used to control oscillations in head. Values range between 0.0 and 1.0, and larger values increase the weight (decrease under-relaxation) applied to the head change.
- *Coefficient to increase weight applied to head change (DBDKAPPA)* – Used to control oscillations in head. Values range between 0.0 and 1.0, and larger values increase the weight applied to the head change.
- *Factor used to weight the head change for iterations $n-1$ and n (DBGGAMMA)* – Values range between 0.0 and 1.0, and greater values apply more weight to the head change calculated during iteration n .
- *Momentum coefficient (MOMFACT)* – Ranges between 0.0 and 1.0. Greater values apply more weight to the head change for iteration n .
- *Use residual control (BACKFLAG)* – Specify whether residual control will be used.
 - 1 = active
 - 0 = inactive
- *Max number of reductions (backtracks) in head change (MAXBACKITER)* – A value between 10 and 50 works well. Only read if residual control is active.
- *Proportional decrease in root-mean-squared error (BACKTOL)* – Only read if residual control is active.
- *Reduction factor for residual control that reduces head change (BACKREDUCE)* – Values should be between 0.0 and 1.0, where smaller values result in smaller head-change values. Only read if residual control is active.

GMRES Specified Options

- *Max number of iterations for the linear solution (MAXITINNER)* – This value is the maximum number of iterations per call to the solver.
- *Method of incomplete factorization used as preconditioner (ILUMETHOD)* – The index for selection of the method for incomplete factorization (ILU) used as a preconditioner.
 - (1) ILU with drop tolerance and fill limit
 - (2) ILU(k), Order k incomplete LU factorization
- *Fill limit for ILUMETHOD 1 or level of fill for ILUMETHOD 2 (LEVFILL)* – Recommended values: 5–10 for method 1, 0–2 for method 2.
- *Tolerance for convergence of linear solver (STOPTOL)* – This is the residual of the linear equations scaled by the norm of the root mean squared error.
- *Number of iterations between restarts of GMRES (MSDR)*

xMD Specified Options

- *Acceleration method (IACL)* – A flag for the acceleration method:
 - (0) conjugate gradient
 - (1) ORTHOMIN
 - (2) Bi-CGSTAB
- *Scheme of ordering unknowns (NORDER)* – A flag with the following options:
 - (0) original ordering
 - (1) RCM ordering
 - (2) Minimum Degree ordering
- *Level of fill for incomplete LU factorization (LEVEL)*

- *Number of orthogonalization for the ORTHOMIN acceleration scheme (NORTH)* – A number between 4 and 10 is appropriate. Small values require less storage but more iterations may be required. Should equal 2 for the other acceleration methods.
- *Reduced system preconditioning (IREDSYS)* – A flag for reduced system preconditioning.
 - (0) do not apply
 - (1) apply
- *Residual reduction-convergence criteria (RRCTOLS)*
- *Use drop tolerance in preconditioning (IDROPTOL)* – A flag for using drop tolerance in the preconditioning.
 - 0 = don't use
 - 1 = use
- *Drop tolerance for preconditioning (EPSRN)*
- *Head closure criteria for inner (linear) iterations (HCLOSEXMD)*
- *Max number of iterations for linear solution (MXITERXMD)*

References

For more information on the NWT package see the USGS documentation at:
water.usgs.gov/nrp/gwsoftware/modflow2000/MFDOC/nwt_newton_solver.htm

PCG Package

The Preconditioned Conjugate Gradient Method (PCG) package is one of the [solver packages](#) for MODFLOW supported by GMS.

Maximum outer iterations (MXITER)

This value is the maximum iterations, or calls to the solver. For linear problems, this value can be 1, unless more than 50 inner iterations are required, when maximum outer iterations could be as large as 10. For non linear problems, this values should be larger, but generally less than 100.

Maximum inner iterations (ITER1)

This value is the maximum number of iterations per call to the solver. The default value is 50, and this is sufficient for most problems.

Matrix Preconditioning Method (NPCOND)

Use this radio group to choose the matrix conditioning method. The default is to use a modified incomplete cholesky method.

Active cells surrounded by dry cells (IHCOFADD)

A flag that determines what happens to an active cell that is surrounded by dry cells:

- 0 – Cell converts to dry. This is the default.
- Not 0 – Cell converts to dry only if HCOF coefficient is 0 (no head-dependent stresses or storage terms)

Head Change Criterion For Convergence (HCLOSE)

When the maximum absolute value of head change from all cells during an iteration is less than or equal to the head change criterion, AND the residual change criterion is met, solver iteration stops.

Residual Change Criterion For Convergence (RCLOSE)

When the maximum absolute value of residuals from all cells during an iteration is less than or equal to the residual change criterion, AND the head change criterion is met, solver iteration stops.

Relaxation Parameter (RELAX)

This value is used if the modified incomplete cholesky method is used. Usually, this value is 1.0, but for some problems a value of 0.99, 0.98, or 0.97 will reduce the number of iterations required for convergence.

Eigenvalue upper bound (NBPOL)

This value is used if the polynomial method is used.

Damping for all, or if <0, only SS stress periods (DAMPPCG)

The damping factor. It is typically set equal to one, which indicates no damping. A value less than 1 and greater than 0 causes damping.

Damping for transient stress periods (DAMPPCGT)

The damping factor for transient stress periods. Only available when when DAMPPCG is specified as a negative value.

Printout interval (IPRPCG)

The printout interval for the PCG package. If equal to zero, it is changed to 999. The maximum head change (positive or negative) and residual change are printed for each iteration of a time step whenever the time step is an even multiple. This printout also occurs at the end of each stress period regardless of the entered value.

Printing of convergence info (MUTPCG)

A flag that controls printing of convergence information from the solver:

- (0) Max head change and residual each iteration
- (1) Total number of iterations
- (2) No printing

- (3) Print only if convergence fails

Reset

This button will change all options to the default state.

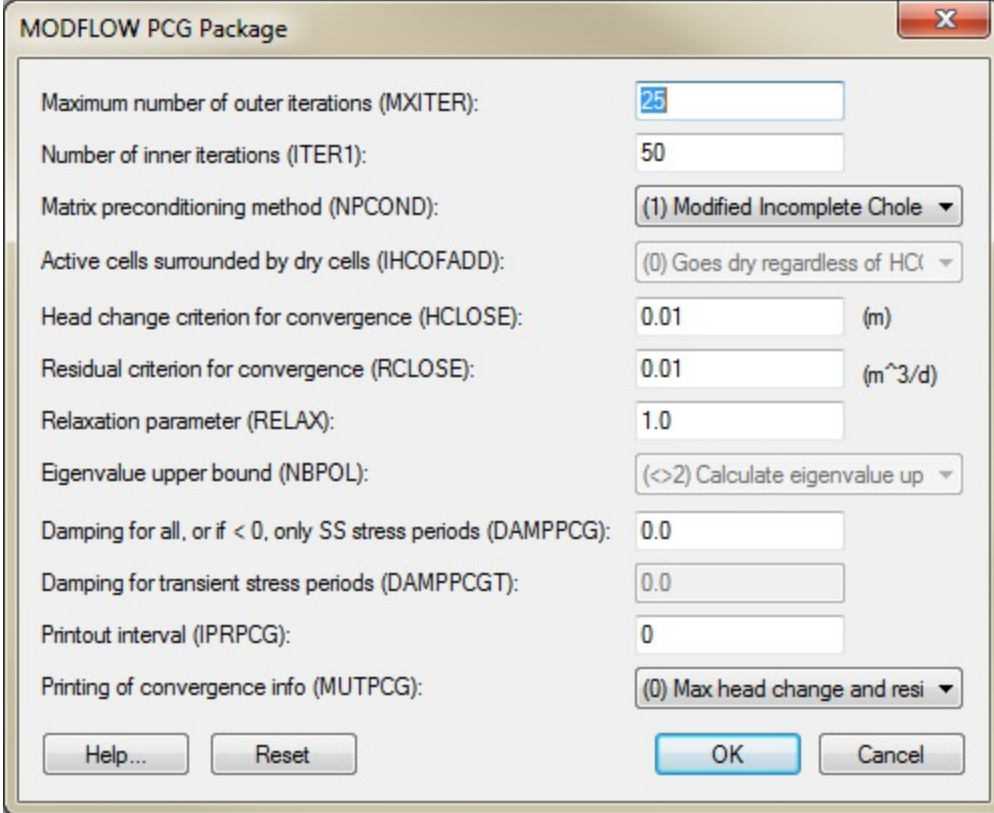

The image shows a dialog box titled "MODFLOW PCG Package" with a close button (X) in the top right corner. The dialog contains several settings for the PCG package, each with a text input field or a dropdown menu. At the bottom, there are four buttons: "Help...", "Reset", "OK", and "Cancel".

Parameter	Value	Unit
Maximum number of outer iterations (MXITER):	25	
Number of inner iterations (ITER1):	50	
Matrix preconditioning method (NPCOND):	(1) Modified Incomplete Chole	
Active cells surrounded by dry cells (IHCOFADD):	(0) Goes dry regardless of HC	
Head change criterion for convergence (HCLOSE):	0.01	(m)
Residual criterion for convergence (RCLOSE):	0.01	(m ³ /d)
Relaxation parameter (RELAX):	1.0	
Eigenvalue upper bound (NBPOL):	(<>2) Calculate eigenvalue up	
Damping for all, or if < 0, only SS stress periods (DAMPPCG):	0.0	
Damping for transient stress periods (DAMPPCGT):	0.0	
Printout interval (IPRPCG):	0	
Printing of convergence info (MUTPCG):	(0) Max head change and resi	

The MODFLOW PCG Package dialog.

PCGN Package

The PCGN package, or Preconditioned Conjugate Gradient Solver with Improved Nonlinear Control, is one of the solvers available for MODFLOW-2005. Using the PCGN solver, a specific GMS MODFLOW executable (mf2k5_..._parallel.exe) can be run with parallel processing on a single machine (though not across multiple machines on a network), greatly reducing run time.

The *MODFLOW PCGN Solver* dialog has the following options:

- *Comments (Text)* – Allows up to 199 characters.
- *Max number of outer iterations (ITER_MO)* – For nonlinear problems, this variable must be set to some number greater than one, depending on the problem size and degree of nonlinearity. If set to 1, then the solver assumes that the problem is linear and the input requirements are greatly truncated.
- *Max number of inner iterations (ITER_MI)* – Set to some number greater than one, depending on the matrix size, degree of convergence called for, and the nature of the problem.
- *Head change criterion for convergence (CLOSE_R)* – If set to 1 then the problem will be linear. If set to be greater than 1 then it will be a nonlinear problem.
- *Residual criterion for convergence (CLOSE_H)* – Used as an alternate stopping criterion for the Picard iteration needed to solve a nonlinear problem.
- *Relaxation parameter (RELAX)* – Relaxation parameter for the modified incomplete Cholesky (MIC) preconditioner. Value can be between 0 and 1. Generally a value between 0.9 and 0.99 is advised for most problems.
- *Preconditioner fill level (IFILL)* – Fill level of the MIC preconditioner. Preconditioners with fill levels of 0 and 1 are available.
 - (0) Less preconditioning
 - (1) More preconditioning

- **Damping mode (ADAMP)** – Defines the mode of damping applied to the linear solution.
 - (0) Ordinary – A constant value of damping parameter $\theta = \text{DAMP}$ will be used.
 - (1) Adaptive – Changes the damping parameter θ in response to the difficulty the nonlinear solver encounters in solving a given problem.
 - (2) Enhanced – The value of θ is increased (but never decreased) provided the Picard iteration is proceeding satisfactorily.
- **Damping restriction (DAMP)** – Restricts the damping parameter θ . Generally is set to be between 0 and 1.
- **Damping bound (DAMP_LB)** – Represents a bound placed on θ .
- **Rate (RATE_D)** – If using adaptive damping, sets the recovery rate for the damping factor θ in response to the progress in the Picard iteration. If using enhanced damping, adjusts the damping factor θ upward.
- **Maximum head change (CHGLIMIT)** – Limits the maximum head change applicable to the updated hydraulic heads in a Picard iteration.
- **Convergence mode (ACNVG)** – Defines the mode of convergence applied to the PCG solver.
 - (0) Standard
 - (1) Adaptive – This option requires a valid value for variable CNVG_LB.
 - (2) Enhanced – This option requires valid values for variables MCNVG and RATE_C.
- **Minimum relative convergence (CNVG_LB)** – Requires adaptive convergence mode. The minimum value that the relative convergence ε is allowed to take under the self-adjusting convergence option.
- **Relative convergence increase power (MCNVG)** – Requires enhanced convergence mode. Increases the relative PCG convergence criteria by a power equal to MCNVG.
- **Relative convergence enhancement (RATE_C)** – Requires enhanced convergence mode. Results in variable enhancement of ε .
- **Progress reporting (IPUNIT)** – Enables progress reporting for the Picard iteration.
 - (-1) None – Suppresses printing of all progress concerning the Picard iteration.
 - (0) Listing file – Prints a record of progress made by the Picard iteration for each time step in the MODFLOW Listing file.

- (1) CSV file – Extensive diagnostics for each Picard iteration is written in comma-separated format to a file whose unit number corresponds to IPUNIT.

For more information on this solver see the [USGS documentation](#).

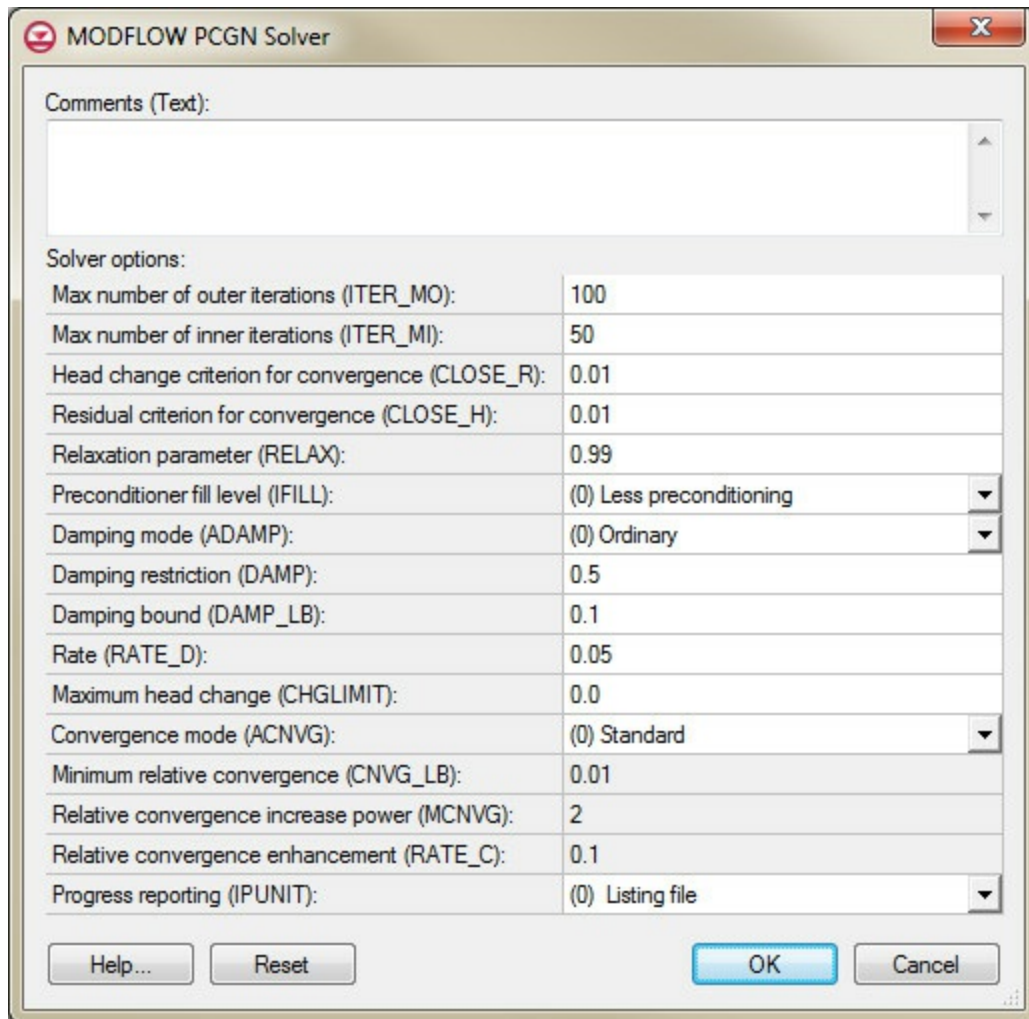

The MODFLOW PCGN Solver package dialog.

PEST ASP Package

When performing [automated parameter estimation](#), a set of optimal parameter values can only be found if [MODFLOW](#) produces a stable solution for all iterations. One of the things that can cause problems with the inverse model is cells going dry. The dry cell flag that is written to the head array can cause instability in the inverse model, and thus it will not converge. When such problems occur, a successful run may be achieved by turning on some convergence options that have been added to the GMS version of MODFLOW by John Doherty. The PEST-ASP package is available in MODFLOW-2000, -2005, -NWT, and -LGR, but not in MODFLOW-USG (which uses an entirely different discretization). Once the package is selected in the [MODFLOW Packages/Processes dialog](#) the PEST ASP options are accessed via the **PEST ASP Package** (Advanced Spatial Parameterization) command in the *MODFLOW | Optional Packages* menu. The options are as follows:

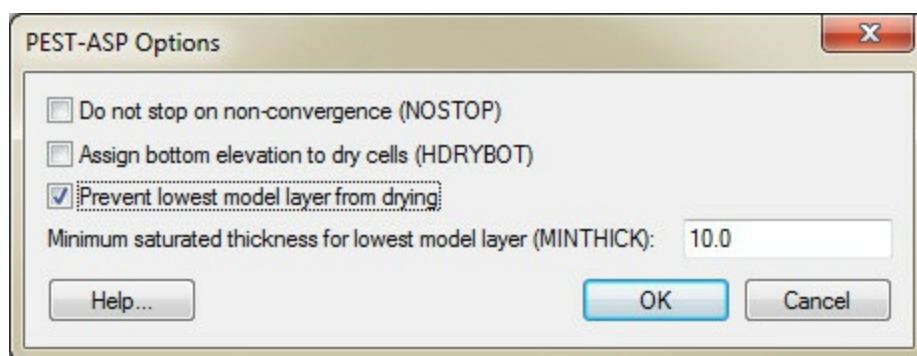

Example of the MODFLOW PEST-ASP Options dialog.

Do Not Stop on Non-Convergence

The *Do not stop ...* option is used for transient simulations. When this option is on, if the MODFLOW model does not converge for a particular time step, it continues to the next time step rather than aborting.

Assign Bottom Elevation to Dry Cells

During a normal MODFLOW run, if a cell goes dry, the HDRY value assigned in the BCF package is assigned to the cell. The default value for HDRY is -888. At each iteration of the inverse model run (each time a MODFLOW solution is found), the inverse model interpolates the computed head values to the observation points and computes the residual error. This error is factored into the objective function. If the head at a cell near an observation point suddenly switches from a normal head value to -888, an extreme discontinuity is introduced to the objective function and the inverse model may not be able to converge. This problem can be avoided by turning on the *Assign bottom elevation to dry cells* option. If this option is on, the bottom elevation associated with the cell is assigned as the head value for the cell.

Prevent Cell Drying

The *Prevent Cell Drying* option does not allow a cell in the bottom layer to go dry. The head is not allowed to drop below the value corresponding to the specified minimum saturated thickness. Additional instruction is provided by Richard Winston and in a [USGS Open-File](#):

Use of the wetting capability can cause serious problems with convergence. There are several methods to avoid this.

1. If a cell should never become wet, make it an inactive cell rather than a variable head cell.
2. Adjust the value of the wetting threshold in WETDRY. (Higher is more stable but may be less accurate.)
3. Decide which neighbors will be checked to decide if a cell should be wetted using WETDRY. Often it is better to allow only the cell beneath the dry cell to rewet it.
4. Use IHDWET to determine which equation is used to specify the head in newly wetted cells.
5. Can vary the wetting factor WETFCT.
6. In steady-state conditions, adjust initial conditions to values that are close to the user's best guess of the final conditions to improve stability.
7. Choose a different solver. The SIP, PCG1, and PCG2 solvers will work with the wetting capability. The SOR solver doesn't work well with the wetting capability. Note that cells can not change between wet and dry during the inner iterations of the PCG1 and PCG2 solvers. The PCG1 solver is no longer included in the USGS version of MODFLOW.
8. When using the PCG2 solver, set RELAX in the range of 0.97 to 0.99 to avoid zero divide and non-diagonally dominant matrix errors. (However, this is an infrequent cause of instability. If such an error occurs, PCG2 prints an error message in the output file and aborts the simulation.)
9. When using the PCG2 solver, set DAMP to a value between 0 and 1.

10. Unrealistically high conductances on boundary cells can contribute to instability. Check the conductances in the Drain, River, Reservoir, Lake, Stream, and General-Head Boundary packages. In the Evapotranspiration check the EVT Flux Stress[i] and EVT Extinction Depth which together control the conductance of evapotranspiration cells.

The two most important variables that affect stability are the wetting threshold and which neighboring cells are checked to determine if a cell should be wetted. Both of these are controlled through WETDRY. It is often useful to look at the output file and identify cells that convert repeatedly from wet to dry. Try raising the wetting threshold for those cells. It may also be worthwhile looking at the boundary conditions associated with dry cells.

Sometimes cells will go dry in a way that will completely block flow to a sink or from a source. After that happens, the results are unlikely to be correct. It's always a good idea to look at the flow pattern around cells that have gone dry to see whether the results are reasonable.

See also

- [Post Processing](#)
- [Solver Packages](#)

RCH Package

MODFLOW Recharge Package

Recharge option (NRCHOP)
(3) Recharge at highest active cell

Multiplier: 1.0

Stress period
1 Use previous

Start Time: 1/1/2021 12:00:00 AM
End Time: 1/1/2022 12:00:00 AM

Edit All Use previous/Multipliers...
2D Dataset -> Array
Array -> 2D Dataset
Constant -> Array

View/Edit: RECH. Flux

	1	2	3	4	5	6	7	8	9	10
1										
2										0.0005
3									0.0005	0.0005
4									0.0005	0.0005
5								0.0005	0.0005	0.0005
6								0.0005	0.0005	0.0005
7							0.0005	0.0005	0.0005	0.0005
8					0.0005	0.0005	0.0005	0.0005	0.0005	0.0005
9			0.0005	0.0005	0.0005	0.0005	0.0005	0.0005	0.0005	0.0005
10		0.0005	0.0005	0.0005	0.0005	0.0005	0.0005	0.0005	0.0005	0.0005
11	0.0005	0.0005	0.0005	0.0005	0.0005	0.0005	0.0005	0.0005	0.0005	0.0005
12	0.0005	0.0005	0.0005	0.0005	0.0005	0.0005	0.0005	0.0005	0.0005	0.0005
13		0.0005	0.0005	0.0005	0.0005	0.0005	0.0005	0.0005	0.0005	0.0005
14		0.0005	0.0005	0.0005	0.0005	0.0005	0.0005	0.0005	0.0005	0.0005

Help...

Units: (m/d)

The MODFLOW Recharge Package dialog.

The Recharge package is used to simulate recharge to an aquifer due to rainfall and infiltration. Recharge is typically defined by specifying a recharge value for each **stress period** for each vertical column in the grid (i.e., a NLAY X NCOL array of values is entered). The recharge value represents the amount of water that goes into the groundwater system and not the amount of precipitation. The units of recharge are length/time, so in a cell with a recharge value of 10(m/day), 10 meters of rainfall each day would be distributed across every m^2 of the cell. The recharge parameters are specified in the *Recharge Package*

dialog. The options in the dialog are as follows:

Recharge Option

Three recharge options are supported by MODFLOW: recharge only at the top layer, recharge at specified vertical cells, and recharge at highest active cells.

Multiplier

The multiplier is a constant which can be written to the package file with each stress period array. Each value in the array is scaled by the multiplier as the array is imported to MODFLOW. The format button brings up a dialog listing the standard MODFLOW formats. This format is used for displaying the values in the spreadsheet and it controls how the values are written to the package file.

Stress Periods

The values displayed in the spreadsheet are for an individual stress period. The values associated with other stress periods can be edited by entering the ID of the desired stress period in the *Stress period* edit box in the center of the dialog. If the *Use previous* option is selected for a given stress period, the values from the previous stress period are used and the spreadsheet is dimmed.

Layer Indicator

If the Recharge at specified vertical cells option is chosen, the layer indicator for each vertical cell can be displayed and edited in the spreadsheet window by selecting Layer indicator in the *View/Edit* option.

Edit All Use previous/Multipliers

This button brings up a spreadsheet allowing the user to edit the *Use Previous values* and the multipliers for the active array for each stress period.

Constant → Array

The **Constant** → **Array** button brings up a dialog which prompts for a single value. This

constant is then assigned to each item in the array for the given stress period.

2D Dataset → Array

The **2D Dataset → Array** button brings up the *Data Browser* listing all of the current datasets associated with the current 2D grid. In order for this button to be active, the 2D grid must have the same number of rows and columns as the 3D grid. The selected dataset is copied to the recharge array. Datasets are typically generated with the 2D Scatter Point module. The 2D Scatter Point module can be used to interpolate from a scattered set of rainfall measurements to the cell locations. If the dataset is transient, the values in the dataset are linearly interpolated, if necessary, to each stress period as the dataset is copied to the array.

Array → 2D Dataset

The **Array → 2D Dataset** button copies the array to the 2D dataset list associated with the existing 2D grid.

Spreadsheet

The recharge flux values for each of the vertical columns in the grid are displayed and edited in the spreadsheet at the lower part of the dialog.

Reset

The **Reset** button deletes all of the data currently defined in the package and restores the package parameters to the default values.

RIV Package

A set of selected cells can be specified as river cells using the **Point Sources/Sinks** command in the *MODFLOW* menu or river cells can be created using the [conceptual model](#) in the [Map module](#). River attributes are typically used with arcs but may also be associated with polygons and points. The river parameters include elevation, stage, and conductance. Elevation is constant. The river stage and conductance may either be constant or vary with time.

When the river attribute is assigned to an arc, the conductance is applied uniformly over the arc, but separate elevations and stage values are applied to each of the nodes on the ends of the arc, and the elevation and stage are assumed to vary linearly between the nodes. When a river object is defined using a polygon or a point, all of the values are assigned directly to the cell(s) overlapped by the polygon or point.

Once a set of river cells has been specified, the *MODFLOW River Package* dialog can be used to view and edit the values assigned to the cells. The options in the dialog are as follows:

Stress Period

This field shows the current stress period and allows users to cycle through the stress periods and view the different river properties for those stress periods in the spreadsheet below.

Use Previous

Use this option on a stress period to use the drain values from the previous stress period for the current stress period. This option is unavailable for steady state models and the first stress period of transient models.

Edit All Use Previous

This button brings up a spreadsheet allowing the user to quickly edit the *Use Previous* flag

for all stress periods.

Spreadsheet

For cells where river type boundary conditions have been assigned, the stage, conductance, bottom elevation, and conductance factor assigned to each cell are displayed in the spreadsheet portion at the lower part of the dialog. The spreadsheet can be used to edit the row, column, layer, stage, conductance, and bottom elevation values. For a transient simulation, the values displayed in the spreadsheet are for an individual stress period. The values associated with other stress periods can be edited by entering the number of the desired stress period in the stress period edit box in the center of the dialog. If the Use previous option is selected for a given stress period, the values from the previous stress period are used and the spreadsheet is dimmed. The conductance factor is used with RIV parameters. When doing parameter estimation the value of river conductance assigned to a particular river boundary condition will be the value of the river parameter multiplied by the conductance factor. For more information on RIV parameters and conductance factors see the MODFLOW 2000 manual.

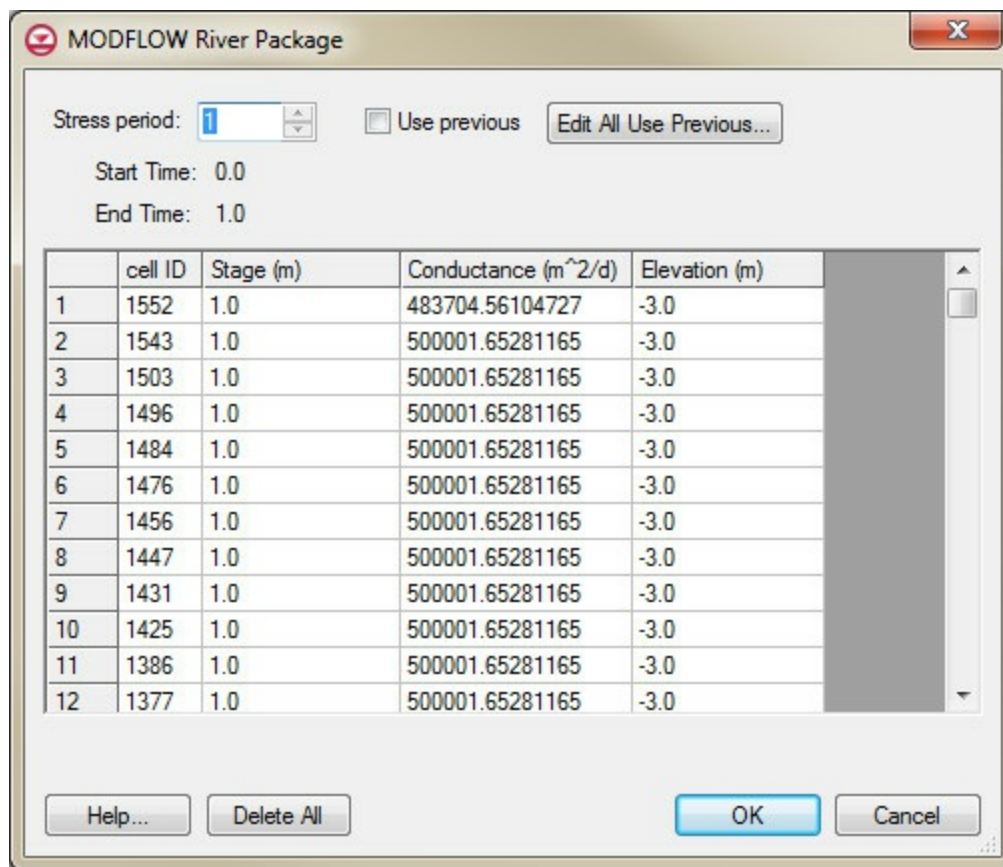

The MODFLOW River Package dialog.

Related Topics

- [Conductance](#)

SIP Package

The SIP (Strongly Implicit Package) solver package is one of the [solver packages](#) for MODFLOW supported by GMS.

Maximum Iterations Per Time Step

This value is the maximum number of times through the iteration loop in one time step in an attempt solve the system of finite-difference equations.

Number of Iteration Parameters

Five variables are generally sufficient.

Acceleration Parameter

This value must be greater than zero and is usually 1.0.

Head Change Criterion For Convergence

When the maximum absolute value of head change from all cells during an iteration is less than or equal to the head change criterion, solver iteration stops.

Print Out Interval

The maximum absolute head change is printed for each iteration of a time step whenever the time step is an even multiple of the print out interval. The printout also occurs at the end of each stress period regardless of the print out interval.

Iteration Parameter Seed

These options control the seed for calculating iteration variables. Either specify the seed yourself or have MODFLOW calculate it.

Reset

This button will change all options to the default state.

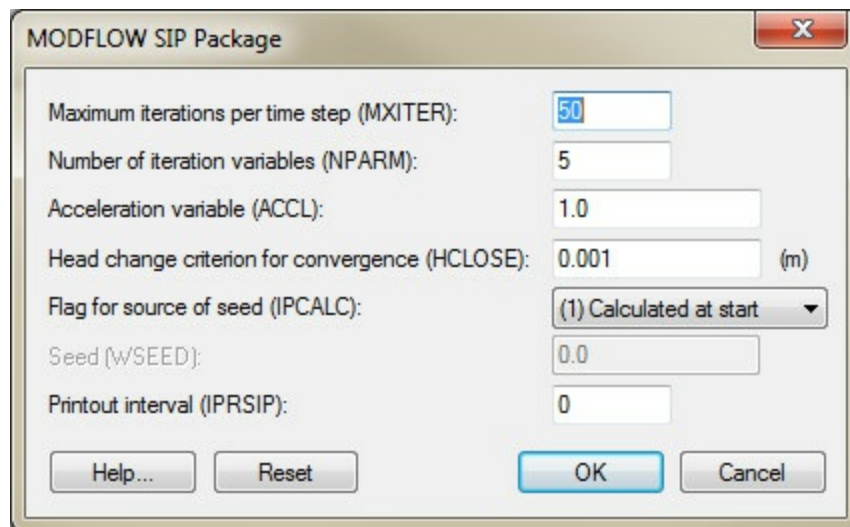

The MODFLOW SIP Package dialog.

SMS Package

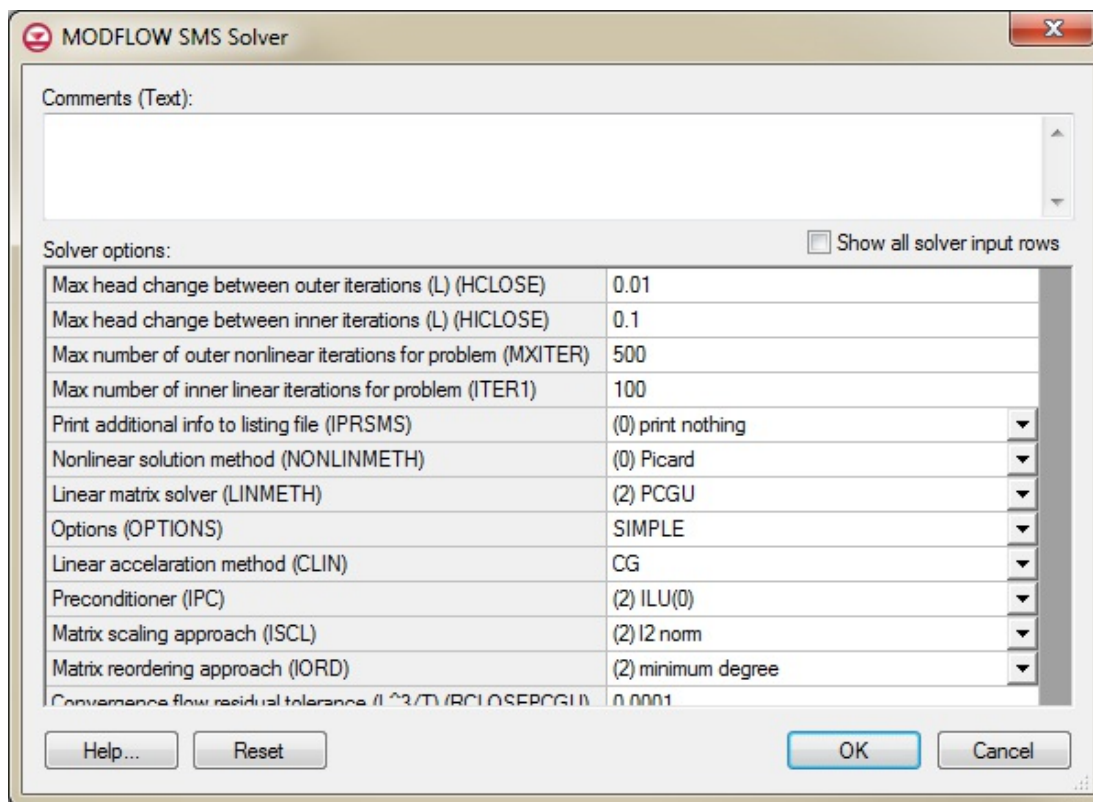

Example of the MODFLOW SMS Solver dialog.

The Sparse Matrix Solver (SMS) package is the only solver package compatible with MODFLOW-USG and is not compatible with other MODFLOW models. The *MODFLOW SMS Solver* dialog has the following options:

- *Comments (Text)* – Allows up to 199 characters.
- Max head change between outer iterations (L)(HCLOSE)
- Max head change between inner iterations (L)(HICLOSE)
- Max number of outer nonlinear iterations for problem (MXITER)
- Max number of inner linear iterations for problem (ITER1)
- Print additional info to listing file (IPRSMS)
 - (0) print nothing

- (1) print summary
- (2) print detail
- Nonlinear solution method (NONLINMETH)
 - (-2) Picard with Cooley
 - (-1) Picard with Delta-Bar-Delta
 - (0) Picard
 - (1) Newton with Delta-Bar-Delta
 - (2) Newton and Cooley
- Linear matrix solver (LINMETH)
 - (1) χ MD
 - (2) PCGU
 - (3) SAMG
- Options (OPTIONS)
 - SPECIFIED
 - SIMPLE
 - MODERATE
 - COMPLEX

More information regarding inputs to the SMS package can be found in the MODFLOW-USG documentation at pubs.usgs.gov.

The SMS package, when used with GMS, also includes the option of using the [SAMG](#) or [LMG](#) within the SMS package. This option is selected under the *Linear matrix solver (LINMETH)* option in the *MODFLOW SMS Solver* dialog.

Nonlinear Solution Method Options

- Delta-bar-delta learning rate reduction factor (THETA)
- Delta-bar-delta learning rate increment (AKAPPA)
- Delta-bar-delta memory term factor (GAMA)
- Nonlinear fraction history added (AMOMENTUM)

- Maximum residual backtracking iterations (NUMTRACK)
- Residual change tolerance (BTOL)
- Residual change reduction size (BREDUC)
- Residual reduction limit (RESLIM)

xMD Options

- Acceleration method (IACL)
 - (0) conjugate gradient
 - (1) ORTHOMIN
 - (2) Bi-CGSTAB
- Ordering scheme (NORDER)
 - (0) original ordering
 - (1) RCM ordering
 - (2) minimum degree ordering
- ILU decomposition level of fill (LEVEL)
- Number of orthogonalizations for ORTHOMIN accel. (NORTH)
- Reduced system (IREDSYS)
 - (0) do not apply
 - (1) apply
- Residual tolerance criterion (RRCTOL)
- Perform drop tolerance (IDROPTOL)
 - (0) do not perform
 - (1) perform
- Drop tolerance value (EPSRN)

PCGU Options

- Linear acceleration method (CLIN)

- CG
- BCGS
- Preconditioner (IPC)
 - (0) None
 - (1) Jacobi
 - (2) ILU(0)
 - (3) MILU(0)
- Matrix scaling approach (ISCL)
 - (0) None
 - (1) POLCG preconditioner
 - (2) l2 norm
- Matrix reordering approach (IORD)
 - (0) Original
 - (1) reverse Cuthill Mckee
 - (2) minimum degree
- Convergence flow residual tolerance (L^3)(RCLOSEPCGU)
- MILU(0) relaxation factor (RELAXPCGU)

SSOR Package

The SSOR package is one of the [solver packages](#) for MODFLOW supported by GMS. The SOR solver only uses a head change convergence criterion and may result in significant volume budget error.

Maximum iterations per time step

This value is the maximum solver iterations per timestep. The default value is 50.

Acceleration Parameter

This value is usually between 1.0 and 2.0

Head change criterion for convergence

When the maximum absolute value of head change from all cells during an iteration is less than or equal to the head change criterion, solver iteration stops.

Print out interval

The maximum absolute head change is printed for each iteration of a time step whenever the time step is an even multiple of the print out interval. The printout also occurs at the end of each stress period regardless of the print out interval.

Reset

This button will change all options to the default state.

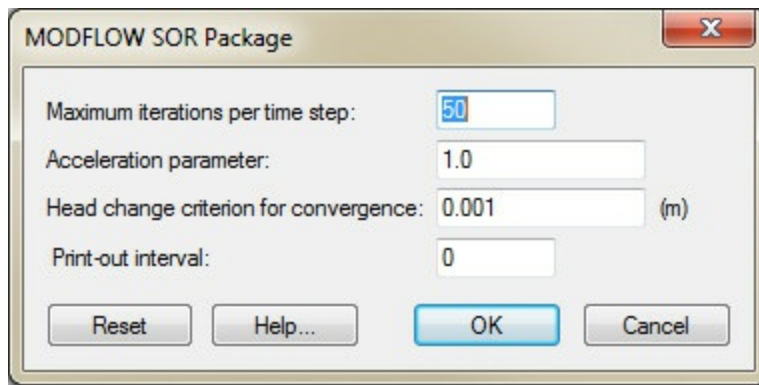

The MODFLOW SOR Package dialog.

STR/SFR Packages

The Stream (written STR or STR1) and Streamflow-Routing (SFR2) packages are used to simulate the interaction between surficial streams and the groundwater. These packages are somewhat similar to the [River package](#) in that water can move from the stream to the aquifer or from the aquifer to the stream depending on the relative differences in the stream stage and the water table elevations. However, unlike the River package, flow is routed through the stream. For the STR package, simple channel hydraulics and Manning's equation are used to compute the stage in the stream. The SFR package has more sophisticated hydraulics and routing options.

Stream Network

When either the STR or SFR package is used, a complete, ordered stream network must be defined as shown in the following figure.

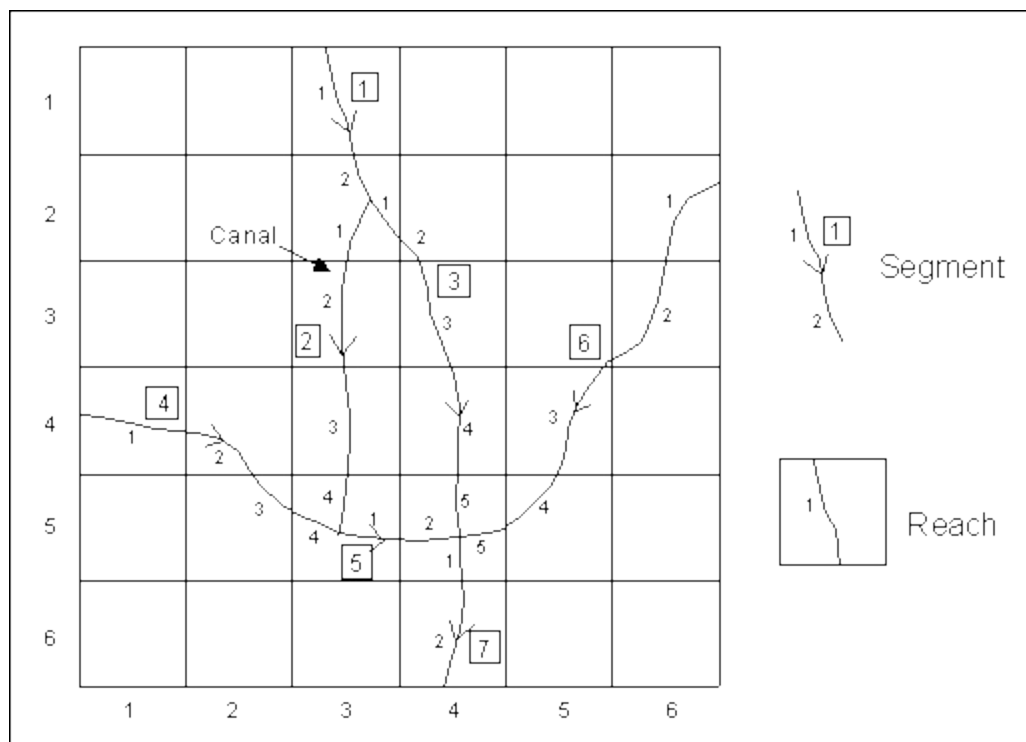

Ordered stream network used by the STR or SFR packages

A stream network is composed of reaches and segments. A reach is the portion of a stream that lies inside a single cell. A single cell may contain multiple reaches. A segment is a group of reaches that forms one section of the stream. The reaches within a segment are always numbered from upstream to downstream. The segments should also be numbered from upstream to downstream.

The incoming flowrate may only be defined for the topmost segments (segments 1, 4, and 6 in the above figure) and is typically entered as a positive value to represent the amount of flow in the stream channel. Flow is then routed and combined to get the incoming flowrate for the other segments. An exception to this is a diversion such as the canal at segment #2 in the above figure. In this case the flowrate into the diversion should be specified. The flow to the diversion would be subtracted from the flow coming out of segment #1 and whatever is left over would be routed to segment #3.

Defining Streams

Unlike other packages in GMS, a stream network cannot be created by selecting cells in the grid and manually assigning values to the cells. Due to the complex nature of the input and the requirement that the data be ordered in a specific fashion, a stream network can only be created using a series of Stream Arcs in the [Map module](#). The cell-by-cell values are automatically created and properly ordered when the [Map](#) → [MODFLOW](#) command is selected.

There are some restrictions on the STR and SFR conceptual models:

- STR and SFR stream arcs cannot both exist in the same coverage because of the stream numbering issues.
- All STR (or SFR) arcs must be in one coverage. There cannot be two or more coverages to represent the stream network.
- SFR – All downstream streams must be diversions except for one. The variable OUTSEG is the segment number of the downstream segment that is not a diversion.
- SFR – If the current segment has the diversion flag set then IUPSEG is the id of the upstream segment.

Set Arc Directions From Stream Data

Right-clicking on a coverage containing STR streams shows a *Set Arc Directions From Stream Data* menu item. This operation will cause all stream arcs to point downhill based on the elevation of the top of the river sediments as defined at the nodes.

STR Package

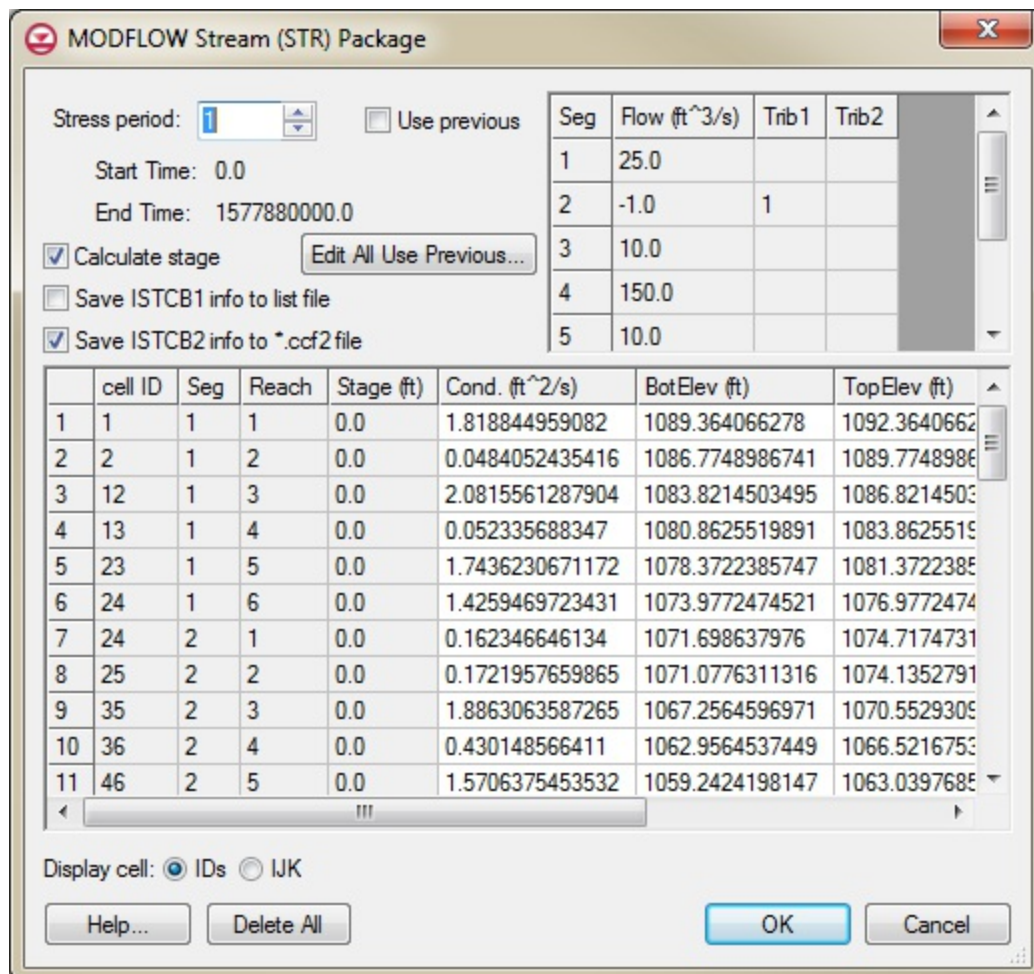

The MODFLOW Stream (STR) Package dialog

In the input file for the STR package, each reach is assigned the following values:

- ijk indices of cell
- segment ID

- reach ID
- stage (typically starting stage)
- conductance
- conductance factor (multiplied by the conductance during parameter estimation)
- Elevation of the bottom of the streambed
- Elevation of the top of the streambed

Each segment is assigned the following values:

- incoming flow (for top segments and diversions)
- width
- slope
- roughness coefficient
- IDs of tributaries (upstream segments)
- ID of upstream segment (for diversions only)

When Manning's equation is used to route the flow through the network, the stream channels are assumed to have a rectangular cross section.

When the **Map** → **MODFLOW** command is selected, GMS automatically does the following: classifies all of the cells beneath the streams as reaches, builds segments, numbers the reaches and segments, and assigns the appropriate values to the reaches and segments. These values defined at the nodes are linearly interpolated across the arcs when the model is converted. The slope assigned to reaches is computed by dividing the difference in the streambed top elevations at the ends of the arc by the arc length multiplied by the sinuosity factor.

The STR Package Dialog

Once the **Map** → **MODFLOW** command is selected and the stream data have been assigned to the grid cells, the data can be viewed and some of the input values can be edited using the *Stream Package* dialog. The options for the *Stream Package* dialog include:

Calculate Stage

The *Calculate stage* toggle is used to specify whether the Stream package should compute the stages (specified stages are initial values only) or whether the specified stages should be used directly.

SFR Package

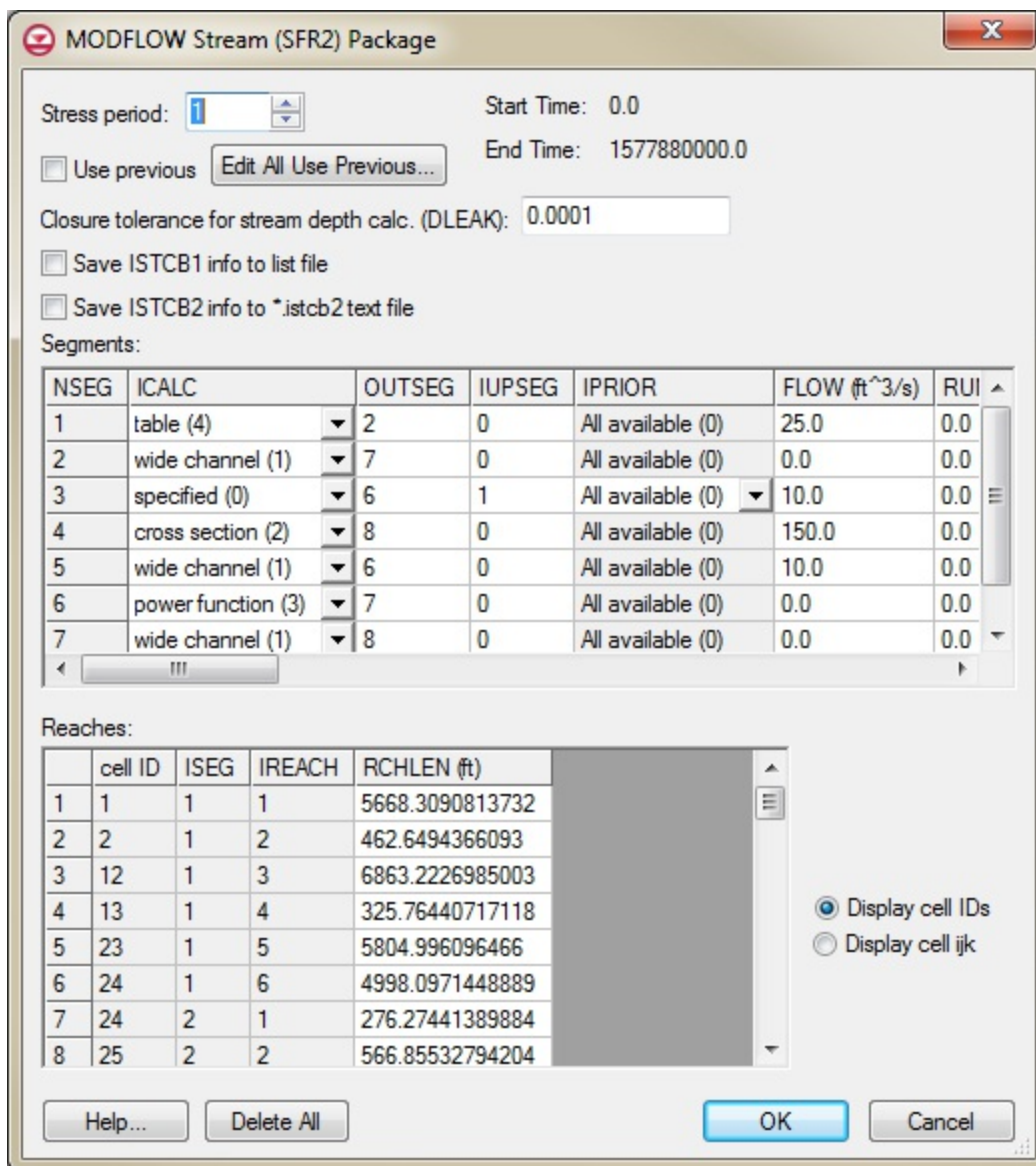

The MODFLOW Stream (SFR2) Package dialog

Support for the SFR2 package was added at GMS version 7.0.

The SFR Package Dialog

Once the **Map** → **MODFLOW** command is selected and the stream data have been assigned to the grid cells, the data can be viewed and some of the input values can be edited using the *SFR Package* dialog. Stream segments and reaches cannot be created in the *SFR Package* dialog—creation can only be done via the **Map** → **MODFLOW** command. The *SFR Package* dialog has two spreadsheets, one showing stream segments and one showing stream reaches. For a further explanation of the columns in each spreadsheet, refer to the [Online Guide to MODFLOW](#). Note: GMS does not currently support the

optional parameters ISFROPT, NSTRAIL, ISUZN, and NSFRSETS which are all defaulted to zero by GMS.

ISTCB2 info

If the *Save ISTCB2 info to *.istcb2 text file* option is on, MODFLOW will save more stream related data to a text file which has the same prefix as the other MODFLOW files and a **.istcb2* extension. This text file will be displayed in the MODFLOW Solution in the [Project Explorer](#) when the solution is imported. The data in this file includes information on "inflows and outflows from each reach; on stream depth, width, and streambed conductance; and on head difference and gradient across the streambed."

If the *Save ISTCB2 info to *.istcb2 text file* option is off, streamflow out of each reach will be saved to the CCF file if the *Save cell by cell flow terms to *.ccf file* is on in the [Output Control](#) dialog.

Starting at GMS 9.0, this information is saved to a second CCF file that will appear in the solution as "CCF2". This is so that the stream flow out of each reach is not included in the flows in and out of the aquifer in the [flow budget](#). The total stream flow out of each reach is displayed at the bottom of the flow budget.

STREAMFLOW_OUT dataset

The stream flow out of each reach is stored in the ccf file under the heading STREAMFLOW_OUT. GMS can convert data in the CCF file to 3D grid datasets that can be contoured by right-clicking on the CCF file in the Project Explorer and using the *CCF → Datasets* command. If in the ccf file multiple flows are listed for the same cell, GMS sums them so that there is only one value for each cell in the resulting dataset. With most data this makes sense because the data represents the total flow into or out of the aquifer due to the BC (wells, river etc). The STREAMFLOW_OUT data is treated the same way, but in this case it doesn't make sense to sum the values because they don't represent flow to or from the aquifer. The problem becomes evident wherever there is more than one stream reach in a cell, which happens wherever a stream segment begins/ends in a cell. The STREAMFLOW_OUT dataset value will be the sum of all the reaches in the cell, which can make it appear as if much more water is flowing down the stream than there should be in that cell. If using SFR2, the user should save the istcb2 data as a text file (described

above) which lists the streamflow out of each segment and reach separately. Despite this problem, the STREAMFLOW_OUT dataset can still be useful for contouring and display purposes.

Documentation

- [STR Package Documentation](#) 1989
- [SFR2 Package Documentation](#) April 2010

SUB Package

The MODFLOW Subsidence (SUB) package simulates aquifer compaction and land subsidence. The SUB package includes the ability to simulate compaction in both elastic (recoverable) and inelastic (not recoverable) interbeds. It also includes the ability to simulate interbeds where drainage from the interbed is immediate (no-delay) or delayed. The MODFLOW SUB package can generate a binary vertical displacement file that is read by GMS and displayed as a dataset in the MODFLOW solution in the Project Explorer. A detailed description of the SUB input is available at [the USGS website](#).

SUB Package Dialog

The *SUB Package* dialog provides an interface for adding and removing subsidence interbeds. The dialog is separated into three tabs. The *Options* tab includes general package options along with a table to edit delay interbed materials. The *Non-Delay Interbed* and *Delay Interbed* tabs allow adding interbeds and editing interbed array values.

Options Tab

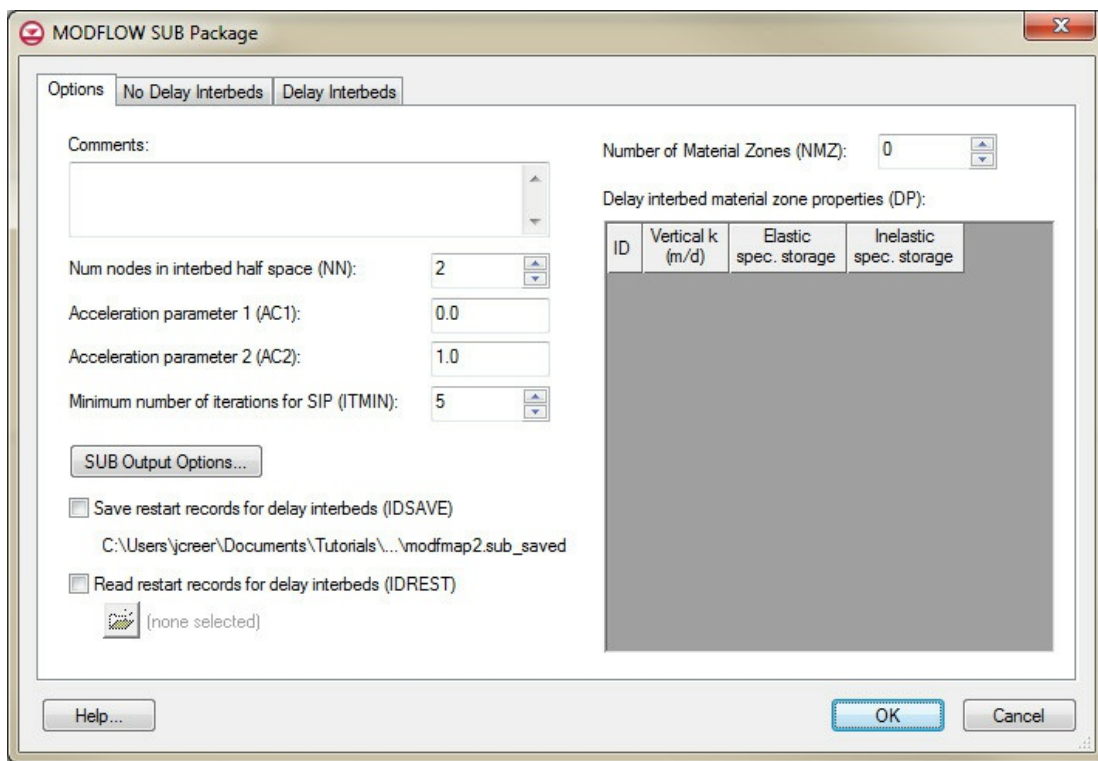

The MODFLOW SUB Package dialog showing the Options tab.

The *Options* tab includes general SUB package options, options for saving and restarting Dstart and DHC values for delay interbeds, and material values for delay interbeds. The options are as follows:

- **NN** – Number of nodes used to discretize the half space to approximate the head distributions in systems of delay interbeds. Defaults to zero when there aren't any delay interbed layers specified.
- **AC1** – Is an acceleration parameter. Used to predict the aquifer head at the interbed boundaries on the basis of the head change computed for the previous iteration. Values may range from 0.0 to 0.6.
- **AC2** – Is an acceleration parameter. It is a multiplier for the head changes to compute the head at a new iteration. Values may range from 1.0 to 2.0.
- **ITMIN** – The minimum number of iterations for which one-dimensional equations will be solved for flow in interbeds when the [SIP package](#) is used.
- **SUB Output Options** – Brings up a dialog where SUB package output options can be set. Values can either be printed to the model output file or saved as a binary file. The

Save vert. disp. (If18) option saves a binary file for vertical displacement that is included in the model solution as a dataset.

- **IDSAVE** – Turning on this toggle causes a file to be saved in the MODFLOW model folder which can be used for IDREST values for a future MODEL run.
- **IDREST** – Turning on this toggle allows a file to be entered which is used as restart values for delay interbeds in place of Dstart and DHC values.
- **NMZ** – Sets the number of SUB package material values for the delay interbeds to be entered in the spreadsheet below. Defaults to zero when the number of delay interbeds (NDB) is zero (i.e. delay interbed layers have not been created).
- **Vertical k** – Vertical hydraulic conductivity for a delay interbed material.
- **Elastic spec. storage** – Elastic specific storage for a delay interbed material.
- **Inelastic spec. storage** – Inelastic specific storage for a delay interbed material.

No Delay and Delay Interbed Tabs

These two interbed tabs provide an interface for editing interbeds. In the spreadsheet to the left, interbeds can be added and removed. Also, the interbed's model layer can be set. The array spreadsheet to the right behaves similar to other areal spreadsheets. To edit a particular interbed array, select the row for the desired interbed in the spreadsheet at the left, and then select the desired array from the View/Edit combo box. The **2D Dataset** → **Array** button can be used to set the viewed array values to a 2D dataset provided the 2D grid has the same number of rows and columns as the 3D grid. The **Array** → **2D Dataset** button can be used to copy the viewed array to a 2D dataset; the same grid size limitations apply. The **Constant** → **Array** button can be used to set all of the values in the viewed array to the same value.

No Delay Interbed Arrays

- **HC** – Array specifying the preconsolidated head of the interbed. For a model with an initial steady state stress period, model cells in which specified preconsolidated head is above the steady state head, the HC value will be set to the steady state head. Has units of length.

- **Sfe** – Array specifying the elastic skeletal storage coefficient.
- **Sfv** – Array specifying the inelastic skeletal storage coefficient.
- **COM** – Array specifying the starting compaction. Has units of length.

Delay Interbed Arrays

- **RNB** – Array specifying the n-equiv of the interbed. This array is also used to define the areal extent of the interbed. For cells beyond the extent of the interbed enter a value less than 1.0.
- **Dstart** – Array specifying the starting head. Has units of length.
- **DHC** – Array specifying the preconsolidated head. For a model with an initial steady state stress period, model cells in which specified preconsolidated head is above the steady state head, the HC value will be set to the steady state head. Has units of length.
- **DCOM** – Array specifying the starting compaction. Has units of length.
- **DZ** – Array specifying the equivalent thickness of the interbed.

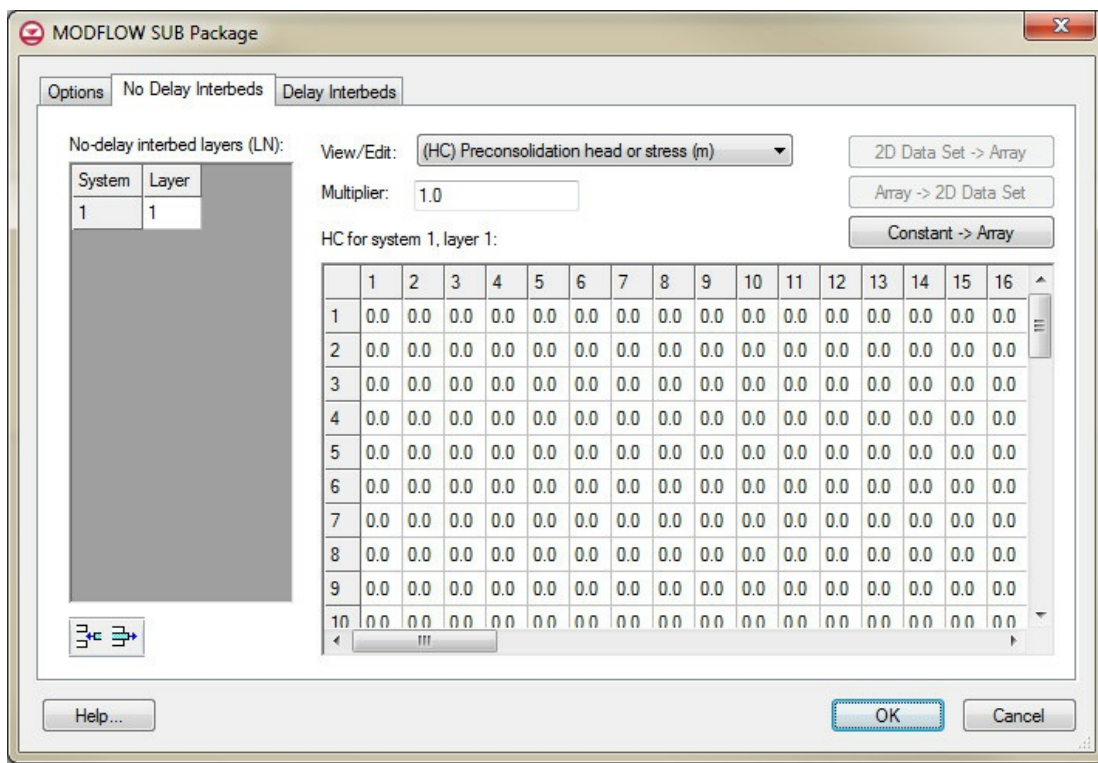

The MODFLOW SUB Package dialog showing the No Delay Interbed tab. The Delay Interbed tab has an identical layout as the No Delay Interbed tab.

External Links

[MODFLOW-2000 User Guide to the SUB Package](#)

SWI Package

The MODFLOW SWI2 (SeaWater Intrusion) package is an optional package in MODFLOW-2005 and MODFLOW-NWT. It can be used to model 3D "vertically integrated variable-density groundwater flow and seawater intrusion in coastal multiaquifer systems."

GMS provides an interface to the SWI2 package. The package can be turned on in the [MODFLOW Packages](#) dialog, accessible from the [MODFLOW Global/Basic Package](#) dialog. The package dialog can be accessed from the main [MODFLOW menu](#) or by right-clicking on the MODFLOW item in the [Project Explorer](#).

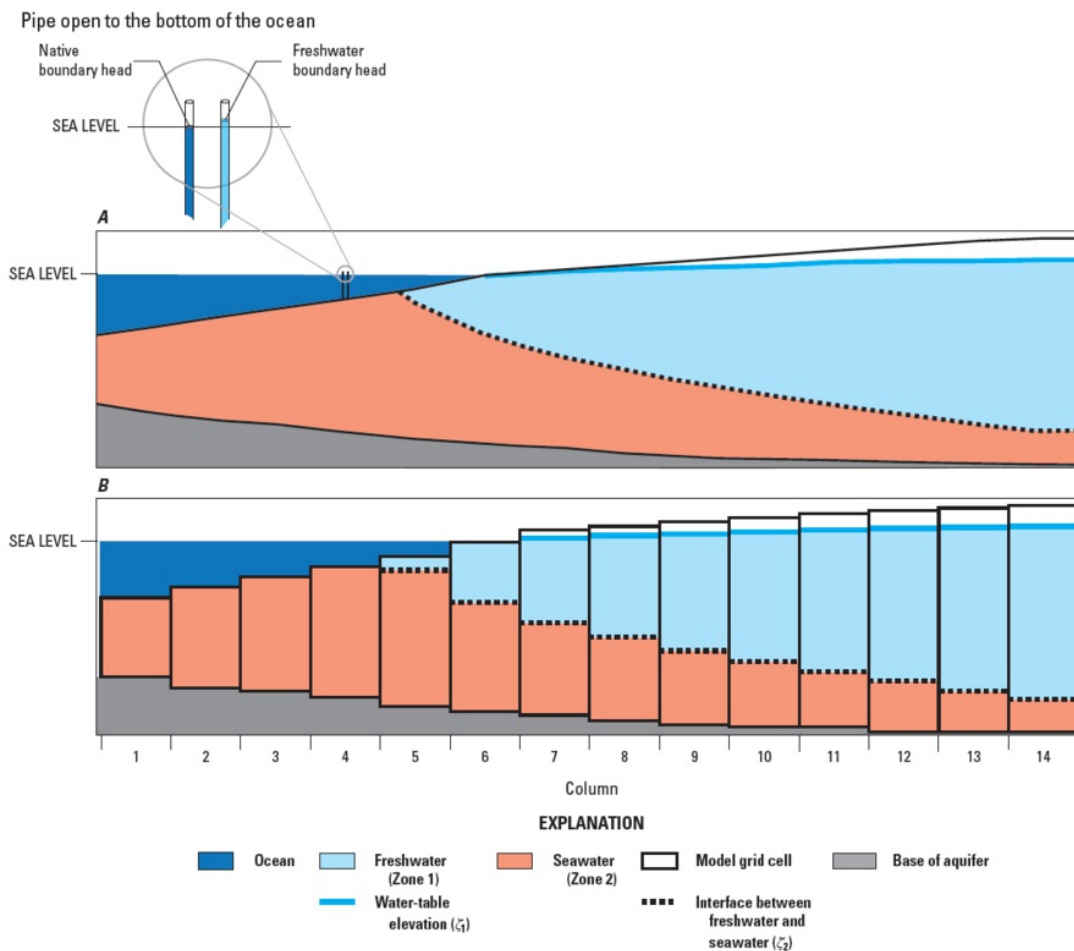

A, cross section through a coastal aquifer with freshwater flowing from right to left and discharging seaward of the coastline; B, cross section through a coastal aquifer discretized using a single model layer. The position of the freshwater-seawater interface is also shown on A and B.

SWI2 Package Dialog

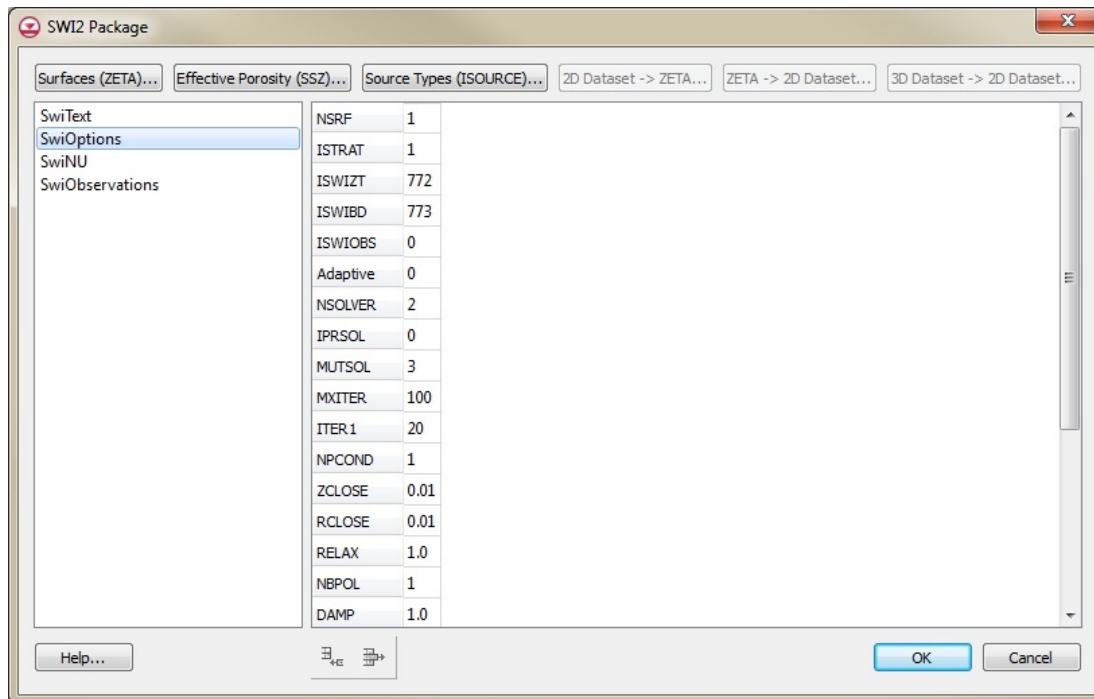

The SWI2 Package dialog

The *SWI2 Package* dialog allows entering the data needed by the SWI2 package. The dialog includes four tables and some arrays. The tables are as follows:

- *SwiText* – A list of lines of text (comments) that can appear at the top of the SWI2 package file.
- *SwiOptions* – A number of variables that control the SWI2 package, consisting of data sets 1-4 in the SWI2 input file. Refer to the SWI2 documentation for the meaning of each variable.
- *SwiNU* – A list of the dimensionless densities for each zone, or for each surface depending on whether a stratified (ISTRAT = 1) or continuous (ISTRAT = 0) simulation is being used, respectively.
- *SwiObservations* – A list of observations.

In addition to these four tables, there are three arrays: **Surfaces (ZETA)**, **Effective Porosity (SSZ)**, and **Source Types (ISOURCE)**. These can be accessed via the three

buttons on the top left of the dialog.

Zeta Surfaces Input

The *Surfaces (ZETA)* button opens an array editor dialog which lets the user enter the data for the zeta surfaces. The zeta surfaces are the interfaces between zones of water of different densities. For example, one zeta surface may be used to divide freshwater from seawater, or two zones may be used to divide freshwater from brackish water and brackish water from seawater. All surfaces are specified in each model layer. This can be confusing. Although we typically think of the freshwater-seawater interface as a two-dimensional surface, the SWI2 package requires the surface be specified for every layer, which makes it a 3D array. As explained in the documentation:

"An elevation for each surface needs to be specified for every cell in the model... For the case of a surface that is present at only one point in the vertical everywhere, the same grid of zeta values may be entered for every model layer and SWI2 will determine in which cells the elevation of the zeta surface falls between the top and [bottom] of each layer..."

The zeta surfaces must be reasonably smooth or they may create difficulties for MODFLOW and MODFLOW may have a harder time converging.

There are a number of options for entering the zeta surface data, including:

- Entering the data by hand in the array editor dialog, or copy/pasting from a spreadsheet for each layer.
- Copying a 2D dataset to each layer of the zeta surface array via the **2D Dataset** → **ZETA** button in the *SWI2 Package* dialog. This requires a 2D grid which matches the 3D grid. A dataset on the 2D grid is chosen and intelligently copied to the zeta arrays.
- Copying a 3D dataset on the 3D grid to the zeta surface array using the **3D Dataset** → **Grid** button in the array editor dialog. The 3D dataset may be created by interpolating from 2D scatter points or a raster.

Post-processing

The SWI2 package output can include a file that contains the calculated positions of the zeta surfaces for every time step. The file format is that of a budget file—the same as the CCF file. To visualize the calculated surfaces, the surface data must first be converted to 3D datasets by right-clicking on the budget file and selecting the **CCF → Datasets** command. These datasets can be contoured on the grid, but a more natural way of viewing the data is to create a 2D surface by using the **3D Dataset → 2D Dataset** button in the *SWI2 Package* dialog. This button launches an algorithm which intelligently converts the 3D dataset to a 2D surface. A 2D grid which matches the 3D grid in X and Y is required. The resulting 2D dataset can be animated over time.

Unfortunately at this time GMS is not able to animate more than one surface at a time because there can only be one 2D grid at a time. Also, although multiple TINs can exist at the same time, only the active TIN will be animated. This is a shortcoming that will be addressed in a future version of GMS.

UPW Package

The UPW (UPstream Weighting) flow package can only be used in a MODFLOW-NWT model. The UPW flow package is based on the [LPF package](#) but differs in that the rewetting and vertical conductance correction options are not available. Also, in a simulation including extraction wells with the LPF package, as soon as the cell goes dry the pumping stops, but with the UPW package the pumping continues at a reduced rate because of the different way wetting and drying are handled. By default the UPW package does not assign the HDRY value to cells that go dry unless the IPHDRY variable is turned on. It also differs from the [LPF package](#) in that it smooths the horizontal conductance and storage change functions to have a continuous derivatives so they can be solved by the Newton method. Using the UPW package requires using the [NWT solver](#), though the NWT solver can be used with the LPF package instead.

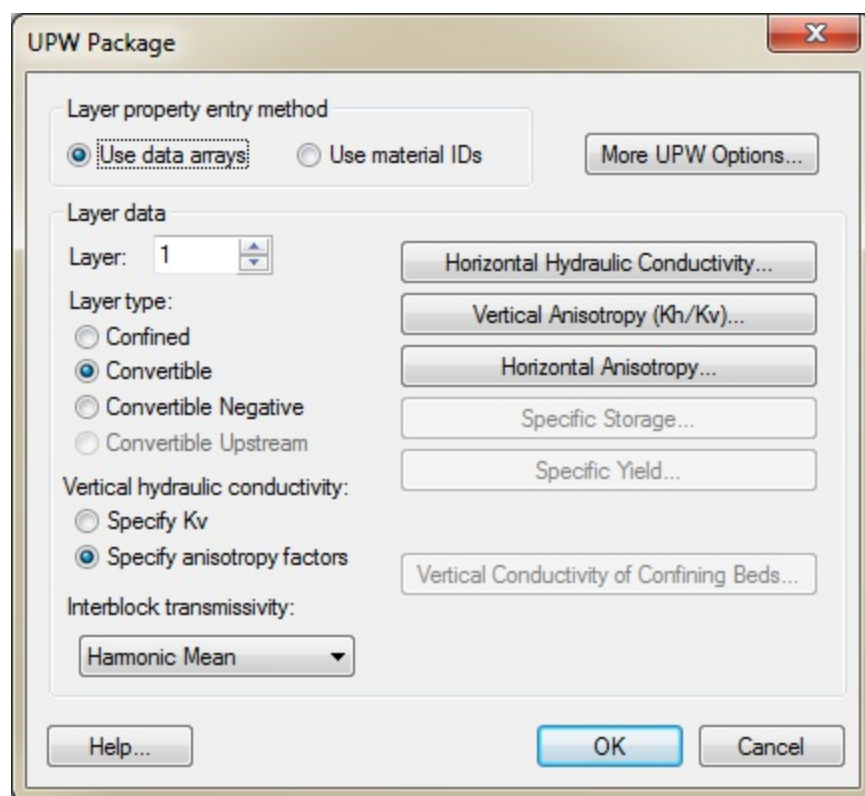

The UPW Package dialog

Use data arrays

This option allows entering conductivities on a layer-by-layer basis. When this option is chosen, the **Horizontal Hyd. Conductivity...**, **Vertical Hyd. Conductivity**, **Specific Storage**, etc. buttons will be available.

Use material ids

This options uses material sets in the place of property arrays. Property values are entered on a material-by-material basis. When MODFLOW files are saved, GMS internally replaces the correct values from the materials to the property arrays. When this option is chose, the property array buttons are replaced with the **Material Properties** and **Material IDs** buttons.

Layer

This field displays the current layer. Selecting any of the input array buttons will display the corresponding layer initially. For multiple layer models, this field can be incremented or decremented to show other layers.

Layer type

This radio group selects the layer type for the current layer. By default, all layers are convertible (where the layer can be either confined or unconfined depending on the elevation of the computed water table). Here layer type can be changed to confined. Only one layer type can be assigned to each grid layer.

Vertical hydraulic conductivity

The UPW package has the option to enter vertical hydraulic conductivity values as either actual hydraulic conductivity values or as anisotropy factors dependant on horizontal hydraulic conductivity. Vertical anisotropy (VKA) "is the ratio of horizontal to vertical hydraulic conductivity. In this case, HK is divided by VKA to obtain VK, and values of VKA typically are greater than or equal to 1.0." These options are only available for multi-layer models.

Interblock transmissivity

The method used for computing interblock transmissivity is specified using the pull-down list

in the middle right portion of the *UPW Package* dialog.

Layer Data Arrays

The seven buttons in the middle-right portion of the dialog represent layer data arrays such as elevations and hydraulic conductivity. Each of the seven buttons brings up the *MODFLOW Array Editor*. Not all of the data arrays need to be specified for each layer. Some arrays such as [specific storage](#) and [specific yield](#) are only required for transient models.

More UPW Options

Clicking on the **More UPW Options** button brings up the *UPW Package Options* dialog where it is possible to remove vertical leakance correction or set a head value for dry cells.

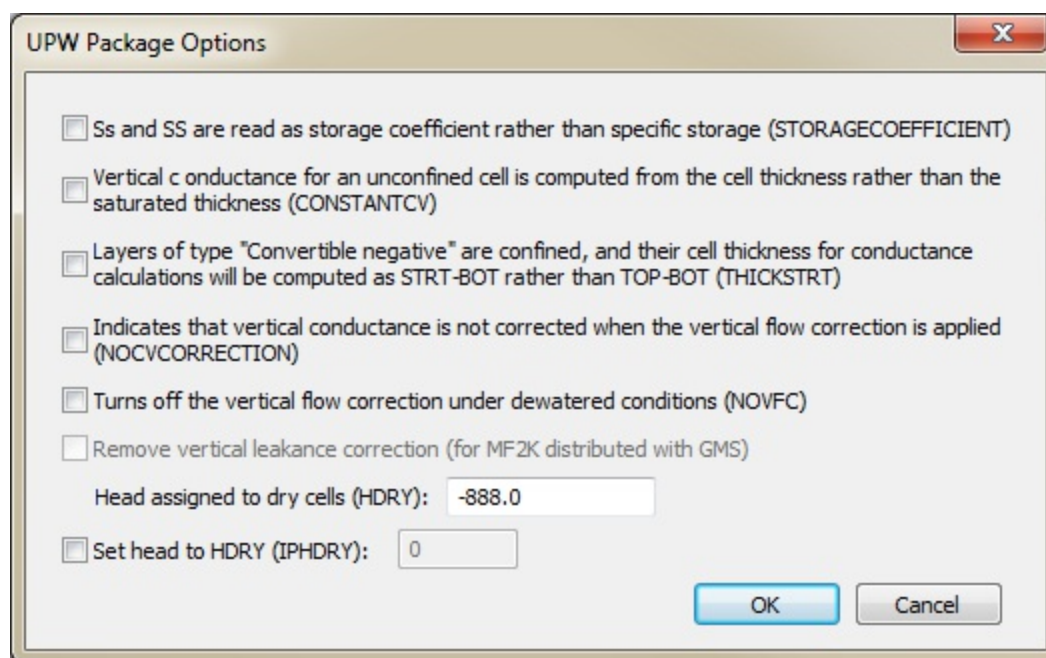

The UPW Package Options dialog

- [USGS UPW package documentation](#)

UZF Package

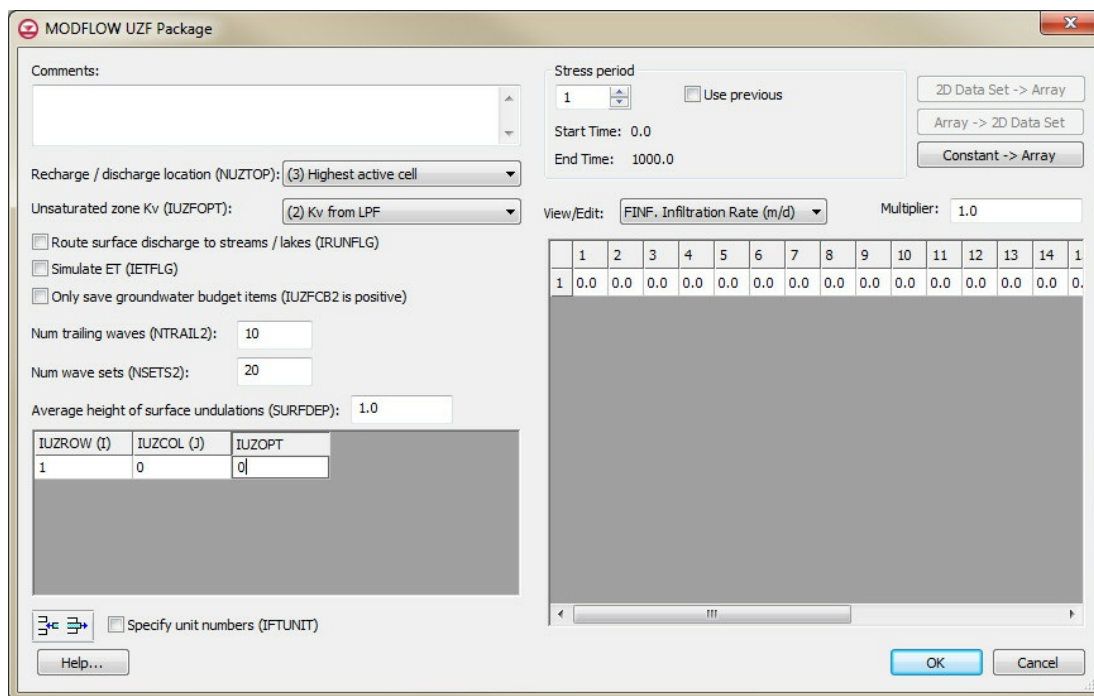

The MODFLOW UZF Package dialog.

The Unsaturated Zone Flow (UZF) package is used to simulate percolation of water through an unsaturated zone. This package is only compatible in GMS with MODFLOW 2005, NWT, and LGR.

The inputs to the UZF package are edited in the *UZF Package* dialog. The inputs to the UZF package are explained [here](#). All of the inputs are labeled using the MODFLOW variable names.

Gages

The spreadsheet with the IUZROW, IUZCOL, IFTUNIT, and IUZOPT columns is used to edit gages associated with the UZF package. By default GMS will assign the unit numbers to the gage files (the IFTUNIT variable). However, the user can specify these values by turning on the toggle below the spreadsheet and entering the unit numbers in the IFTUNIT column. Gages can be added or removed by selecting the insert or delete buttons below this

spreadsheet.

Care should be taken to enter unique unit numbers. The user can inspect the MODFLOW name file (*.mfn) written by GMS to ensure that the specified unit numbers are unique.

Multiplier

The multiplier is a constant which can be written to the package file with each array. Each value in the array is scaled by the multiplier as the array is imported to MODFLOW.

Stress Periods

The values displayed in the spreadsheet are for an individual stress period for the first 4 arrays (FINF, PET, EXTDP, and EXTWC). The other arrays are not specified per stress period.

The values associated with different stress periods can be edited by entering the ID of the desired stress period in the Stress period edit box. If the Use previous option is selected for a given stress period, the values from the previous stress period are used and the spreadsheet is not editable.

Constant → Array

The **Constant** → **Array** button brings up a dialog which prompts for a single value. This constant is then assigned to each item in the array for the given stress period.

2D Dataset → Array

The **2D Dataset** → **Array** button brings up the *Data Browser* listing all of the current datasets associated with the current 2D grid. In order for this button to be active, the 2D grid must have the same number of rows and columns as the 3D grid. The selected dataset is copied to the recharge array. Datasets are typically generated with the 2D Scatter Point module. The 2D Scatter Point module can be used to interpolate from a scattered set of rainfall measurements to the cell locations. If the dataset is transient, the values in the dataset are linearly interpolated, if necessary, to each stress period as the dataset is copied to the array.

Array → 2D Dataset

The **Array → 2D Dataset** button copies the array to the 2D dataset list associated with the existing 2D grid.

Spreadsheet

The values for the array listed in the *View/Edit* selection box are shown in the spreadsheet.

WEL Package

A set of selected cells can be specified as wells using the **Point Sources/Sinks** command in the *MODFLOW* menu or by using the [conceptual model](#) in the [Map module](#). Wells are specified by assigning a pumping rate to a selected cell at the location of each well. Wells can be either injection wells (positive flow rate) or extraction (negative flow rate) wells.

Once a set of cells has been specified, the *Well Package* dialog can be used to view and edit the values assigned to the cells.

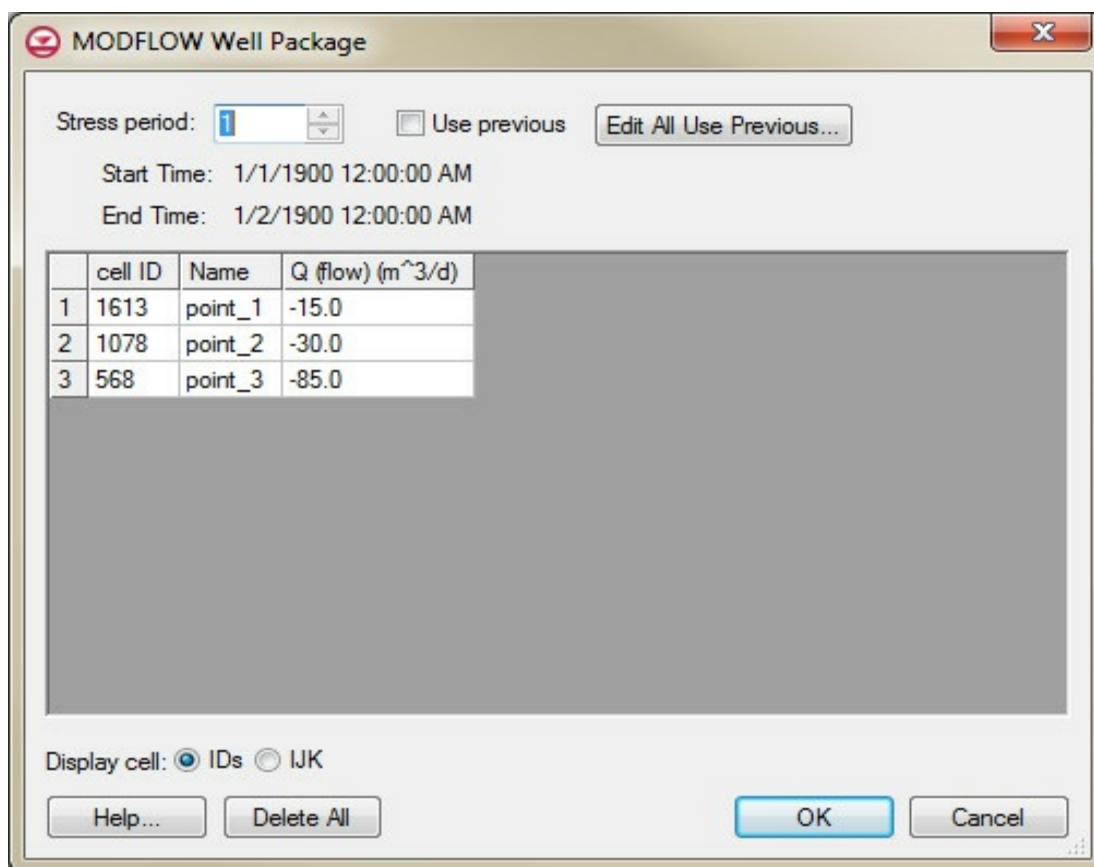

The MODFLOW Well Package dialog.

Stress Period

The *Stress Period* field shows the current stress period and allows users to cycle through the stress periods and view the different well properties for those stress periods in the spreadsheet below.

Use Previous

Use this option on a stress period to use the drain values from the previous stress period for the current stress period. This option is unavailable for steady state models and the first stress period of transient models.

Edit All Use Previous

This button brings up a spreadsheet which allows editing the *Use Previous* flag for all stress periods.

Spreadsheet

For cells where well type boundary conditions have been assigned, the well flow rate for each cell is displayed in the spreadsheet portion at the lower part of the dialog. The spreadsheet can be used to edit the well name, row, column, layer, and flow values.

For a transient simulation, the values displayed in the spreadsheet are for an individual stress period. The values associated with other stress periods can be edited by entering the number of the desired stress period in the stress period edit box in the center of the dialog. If the Use previous option is selected for a given stress period, the values from the previous stress period are used and the spreadsheet is dimmed.

The conductance factor is used with WEL parameters. When doing parameter estimation the value of well conductance assigned to a particular well boundary condition will be the value of the well parameter multiplied by the conductance factor. For more information on WEL parameters and conductance factors see the MODFLOW 2000 manual.

Display Cell IDs/IJK

The radio group at the bottom of the dialog allows the user to adjust whether the cell ID or the cell i, j, k values are displayed for the cells containing the boundary condition/source/sink.

Delete All

The **Delete All** button deletes all of the data currently defined in the River package and

restores the River package parameters to the default values.

6.4.2. MODFLOW Pre-Processing

Building a MODFLOW Model

Two basic approaches are provided in GMS for constructing a MODFLOW model: the model can be completely defined using the tools in the [3D Grid module](#), or the model can be defined with the aid of the feature objects in the [Map module](#). Also, [scatter points](#) and [solids](#) can be used to define layer elevation, and [boreholes](#) can be used with [TPROGS](#) to create material sets for the 3D grid.

Basic Steps in Building a MODFLOW Model

The basic steps in building a MODFLOW model include:

1. Build a 3D grid defining the extents of the model. Two approaches are available:
 - [MODFLOW Grid Approach](#)
 - [MODFLOW Conceptual Model Approach](#)
2. Initialize MODFLOW
3. Assign boundary conditions and model stresses, including sources and sinks
4. [Define layer elevations](#)
5. Assign material properties
6. Run MODFLOW

MODFLOW Array Editor

The *MODFLOW Array Editor* is used throughout the MODFLOW interface to edit array based data. The precise name of this dialog changes depending on which data is being accessed. The editor can include the following features:

Spreadsheet

The array is displayed in a spreadsheet and each value can be selected and edited. Individual layers in the array are displayed one at a time. The edit fields in the spreadsheet associated with inactive cells are dimmed.

Material ID Legend

Shown when accessing the array editor from the [LPF](#) or [UPW](#) flow package dialog. This table shows the material name and material ID. The table is populated based on the [Materials properties](#) dialog.

Layers

The edit field in the upper left corner of the dialog is used to switch to a different layer.

Multiplier

The *Multiplier* is a value that can be specified to scale all of the values in the array.

Edit All Mult

This button brings up a spreadsheet with the multiplier for each layer in the grid.

Constant → Grid

The **Constant → Grid** button prompts for a single value and assigns the value to all of the cells in the entire array.

Constant → Layer

The **Constant** → **Layer** button prompts for a constant value which is assigned to all of the cells in the currently displayed layer.

3D Dataset → **Grid**

The **3D Dataset** → **Grid** button brings up the *Select Dataset* dialog listing all of the current datasets associated with the 3D grid. The selected dataset is then copied into the starting heads array. This option is typically used to load in a previously computed MODFLOW solution to use as the initial condition. The previously computed solution must be imported as a dataset before selecting this option.

2D Dataset → **Layer**

The **2D Dataset** → **Layer** button allows the user to select one of the datasets associated with a 2D grid and copy it to the current layer of the starting heads array. In order for this button to be active, a 2D grid that has the same number of rows and columns as the 3D grid must be imported or created. Such a grid can be automatically generated using the **Grid** → **2D Grid** command in the *Grid* menu. The *2D Dataset* → *Layer* option is typically used to load in a dataset that has been created by interpolating heads from a 2D scatter point set to the 2D Grid.

Grid → **3D Dataset**

The **Grid** → **3D Dataset** button copies values from the entire starting heads array to the 3D grid dataset list.

Layer → **2D Dataset**

The **Layer** → **2D Dataset** button copies values from the selected layer of the starting heads array to the 2D grid dataset list.

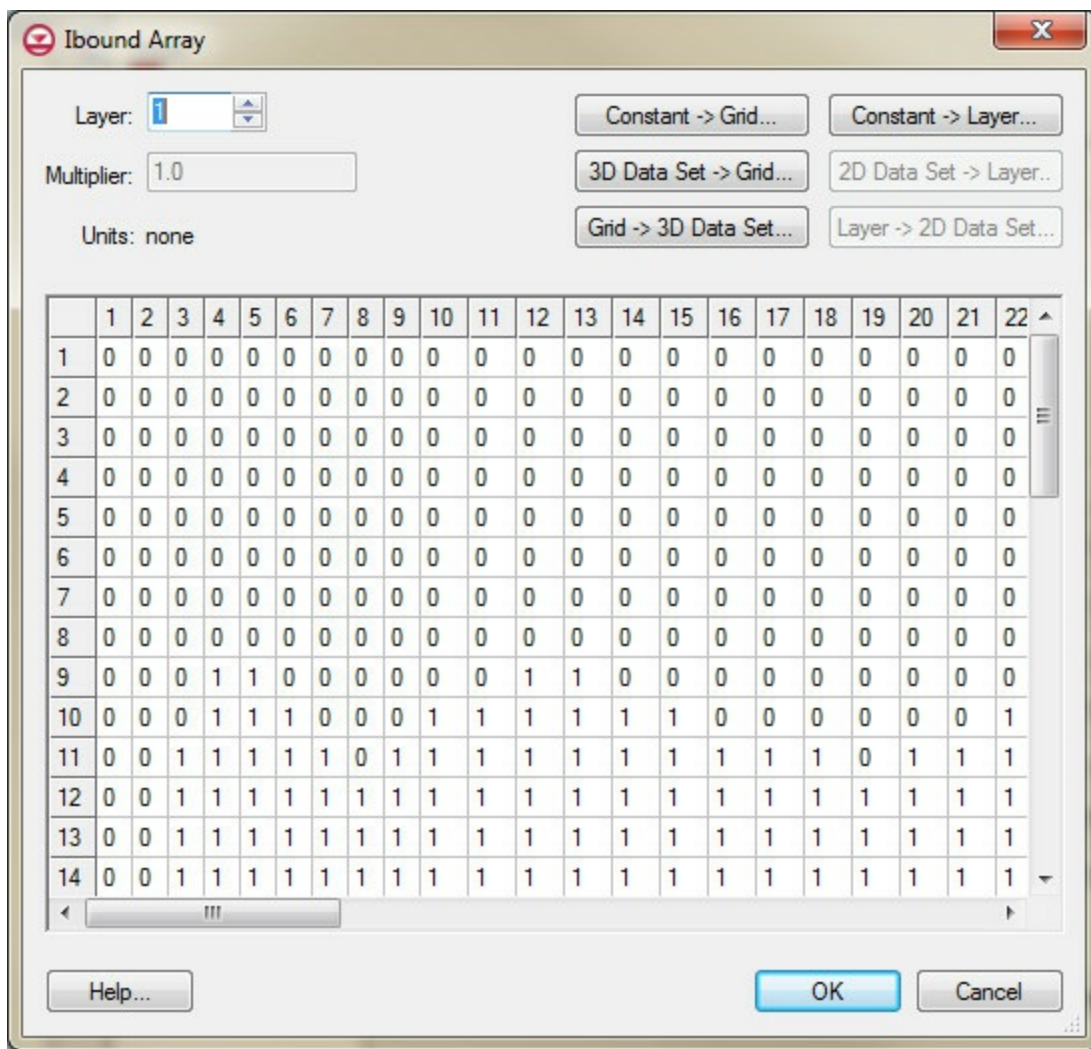

An example of the MODFLOW Array Editor showing the IBOUND Array

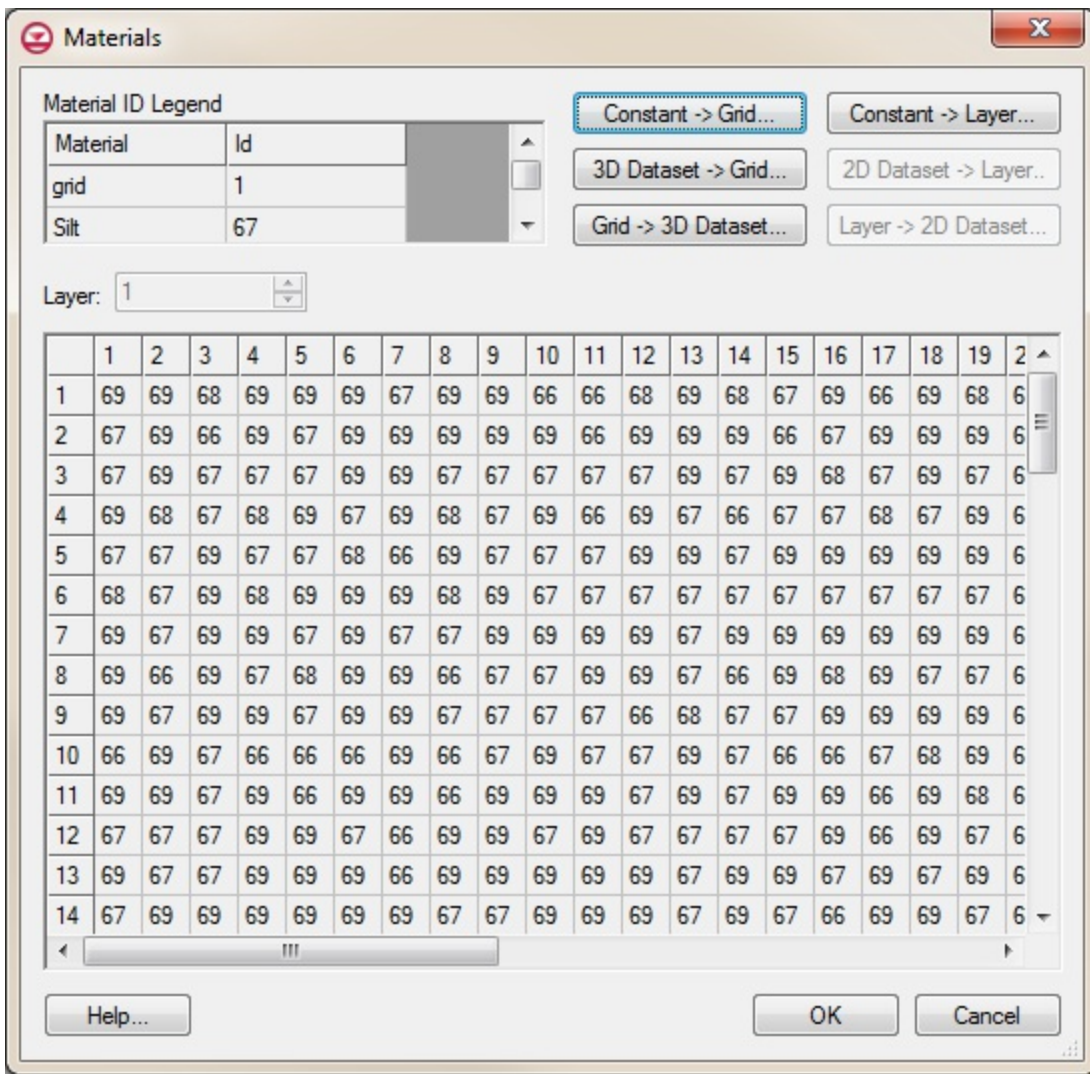

Example of the Materials ID editor array dialog

MODFLOW Grid Approach

Building a MODFLOW 3D Grid

For models with simple geometry and boundary conditions, the entire model can be constructed using the tools and commands in the 3D Grid module. With this approach, the editing of the MODFLOW data is performed directly on the grid on a cell-by-cell basis. The main steps are as follows:

1. Create a 3D cell-centered grid covering the domain to be modeled using the **Create Grid** command in the *Grid* menu.
2. Use the commands in the *MODFLOW* menu to initialize and define the data required by the MODFLOW [packages](#).
3. Boundary conditions such as wells are defined by selecting the cells and assigning the attributes directly to the cells.

Defining Layer Data

An important part of a MODFLOW model is the definition of the layer data (hydraulic conductivity, layer elevations, leakance, etc.). While both the [Grid](#) and [Map](#) module approaches to constructing a MODFLOW model can be used to define the layer data, both approaches may lead to an overly simplistic definition of the stratigraphy. Layers with spatially varying thicknesses can be handled most effectively using a [special set of layer data tools](#) provided in GMS. Solids can also be used to define layer data with the **Solids→MODFLOW** and **Solids→HUF** commands.

MODFLOW Conceptual Model Approach

A MODFLOW model can be created in GMS using one of two methods: assigning and editing values directly to the cells of a grid (the grid approach), or by constructing a high level representation of the model using feature objects in the [Map module](#) and allowing GMS to automatically assign the values to the cells (the conceptual model approach). Except for simple problems, the conceptual model approach is typically the most effective.

Definition

In GMS, the term conceptual model is used in two different ways. In the generic sense, a conceptual model is a simplified representation of the site to be modeled including the model domain, boundary conditions (BCs), and material zones. GMS also has a conceptual model object, that can be defined in the [Map module](#). The conceptual model object can contain coverages.

A conceptual model object can be defined in the [Map module](#) using [feature objects](#), such as points, arcs, and polygons. The conceptual model is constructed of the numerical grid. Once the conceptual model object is defined, a grid can be automatically generated to fit the conceptual model. The boundary conditions and model parameters are computed and assigned to the proper cells. The MODFLOW data are converted from the conceptual model to the cells of the grid. This approach to modeling fully automates the majority of the data entry and eliminates the need for most or all of the tedious cell-by-cell editing traditionally associated with MODFLOW modeling. Once the conceptual model is constructed and [converted to a grid](#), the package dialogs and interactive editing tools in the *MODFLOW* menu can be used to edit or review the data if desired.

A complete conceptual model object consists of several coverages. One coverage is typically used to define the sources and sinks such as wells, rivers, lakes, and drains. Another coverage (or the same coverage) is used to define the recharge zones. Other coverages can be used to define the zones of hydraulic conductivity within each layer. Any number of coverages may be used, or all these attributes may exist in the same coverage.

In addition to the feature data, a conceptual model may include other data (scatter points, boreholes, solids) to define the layer elevations. A specialized set of tools for manipulating layer elevation data is provided in GMS.

Steps in Developing a Conceptual Model

Several steps are involved in setting up a MODFLOW conceptual model and converting the conceptual model to a numerical model. The basic steps are as follows:

1. Create a MODFLOW conceptual model in the Map module.
2. Decide how many coverages are needed and what attributes are wanted with each. It is typical to use three coverages, each with a different purpose. One coverage is used for sources and sinks, like wells, specified head boundaries etc. Another coverage is used for recharge, and another is used for hydraulic conductivity. However, it is not required to use coverages in this manner, and the attributes associated with a coverage are user defined, so define a coverage with any combination of attributes. Thus, if the recharge zones were the same as the hydraulic conductivity zones, it is possible to use just one coverage for both.
3. Create the sources and sinks. The most effective way to do this is with the aid of a background [Image](#). A digital image representing a scanned map or an aerial photo of the site can be imported and displayed in the background using the image tools. Once the image is displayed, [feature objects](#) defining the model boundary, rivers, lakes, flow barriers, and specified head boundaries can be created on top of the background image.
4. Create the areal features, such as recharge zones and evapotranspiration zones.
5. Create the layer features, such as hydraulic conductivity zones.
6. Use the [Grid Frame](#) command to place an outline of the numerical grid on the conceptual model. The frame is placed so that it just surrounds the conceptual model. The frame can be rotated if necessary if the major axis of the model is at an angle.
7. Use the *Feature Objects* | **Map** → **3D Grid** command to automatically generate a grid. The location of the grid is controlled by the Grid Frame and the density of the grid is

automatically adjusted around user-specified points (typically wells).

8. Define the active region of the grid using the **Activate Cells in Coverage** command. This automatically activates all of the cells within the boundary of the conceptual model and inactivates all cells outside the boundary.
9. Initialize the MODFLOW data by selecting the **New Simulation** command in the *MODFLOW* menu. Select the type of mode (steady state vs. transient) and define **stress periods** if necessary. Define a set of starting heads. Go to the *LPF/BCF/HUF Package* dialog and define the layer type for each of the layers in the grid.
10. Select the **Map → MODFLOW** command to automatically assign the MODFLOW boundary conditions, stresses, and material properties to the appropriate cells in the grid.
11. Use the **specialized interpolation** tools to define the layer elevations.

In many cases, it is useful to repeat some, but not all, of these steps. For example, suppose after running a simulation it is determined that one of the boundaries of the model corresponding to a groundwater divide is not properly located. The boundary can be moved by simply selecting and dragging the vertices and nodes of the arc(s) defining the boundary. Once the boundary is moved, step 6 should be repeated to redefine the active/inactive regions and then step 8 is repeated to reassign the model data to the cells.

Example Application

To illustrate the conceptual model approach, consider the site shown in the following figure. It represents information that might be available from a combination of sources including maps, photos, and GIS data. This information may include the location of hydrologic features as well as hydrologic properties of the site. However, this information is not yet organized into a form that is useful to a numerical model.

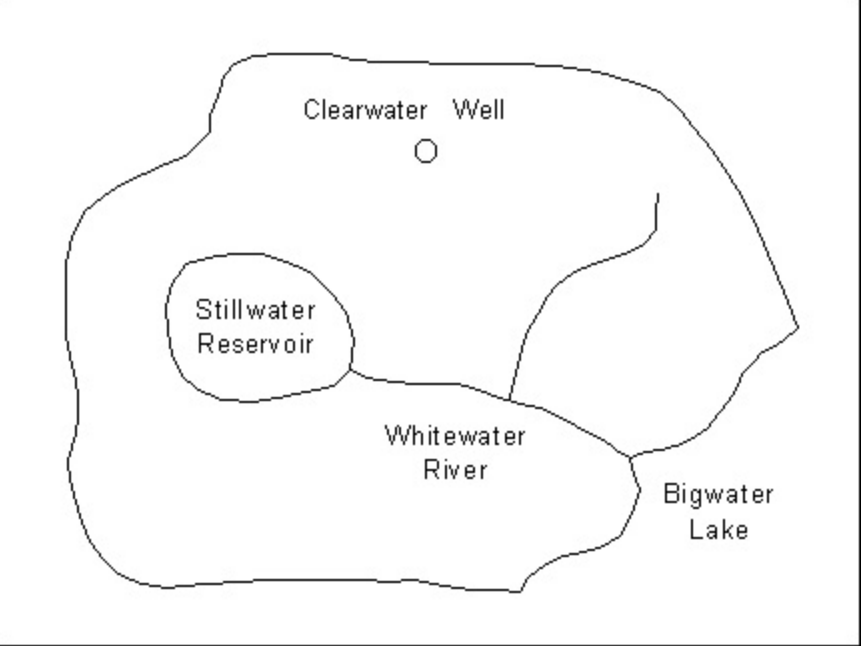

The first step in creating a conceptual model of this site is to create points, arcs and polygons that represent hydrologic features at the site. These points, arcs and polygons are assigned types that correspond to the feature they represent. Based on the attribute type, parameters such as head, concentration and conductance are assigned to these feature objects. The resulting coverage is shown in the following figure. Other coverages, defining such things as recharge zones, would also be defined.

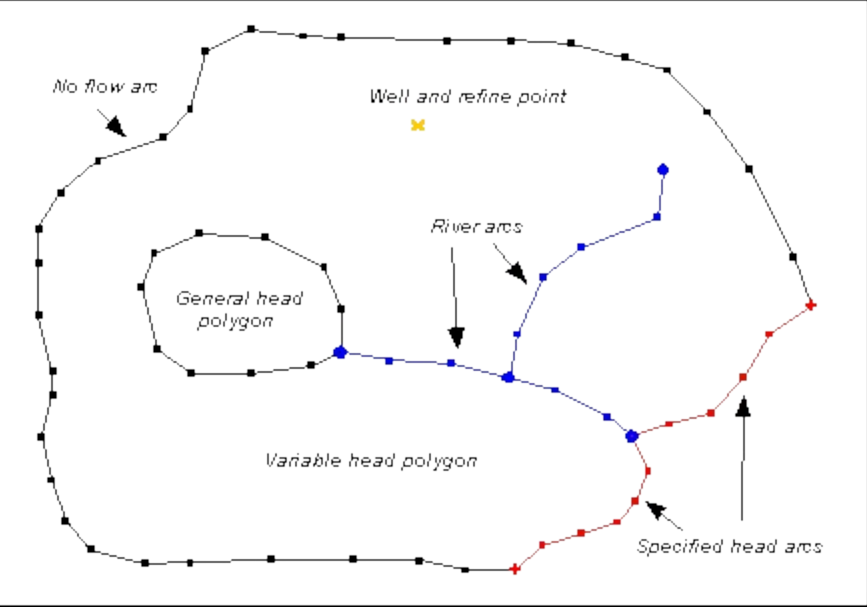

The final step is to take the information that is stored in the conceptual model and construct a numerical model. GMS automates both the creation of the grid geometry as well as assigning boundary conditions and material parameters to the grid. Refine points can be used to specify areas where the grid should have a high density. By specifying polygons that represent the domain of the model, it is possible to automatically inactivate all the cells

that lie outside that domain. Boundary conditions may be applied to the individual cells that are intersected by specified feature objects. In addition to determining which cells are assigned boundary conditions, GMS also calculates the appropriate values to assign to each stress period of a transient simulation. The resulting numerical model is illustrated in the following figure.

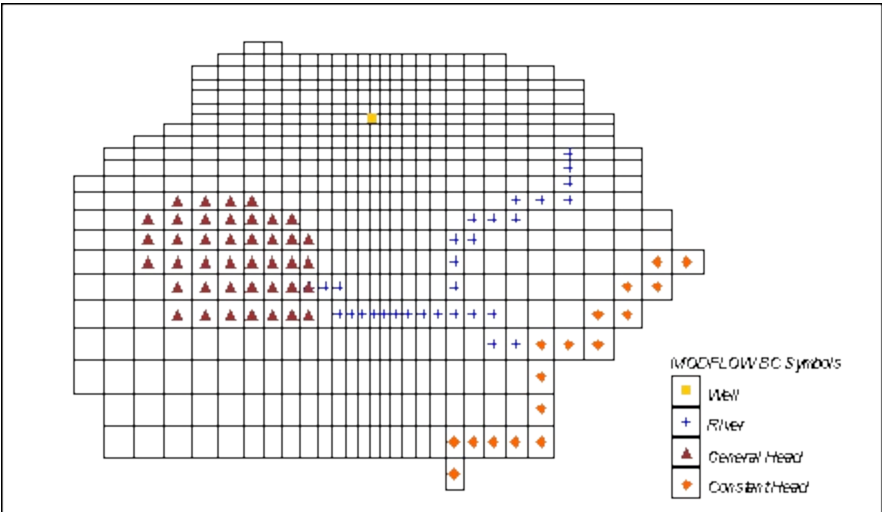

Advantages of the Conceptual Model Approach

There are numerous benefits to the conceptual model approach. First of all, the model can be defined independently of the grid resolution. The modeler does not need to waste valuable time computing the appropriate conductance to assign to a river cell based on the length of the river reach within the cell. This type of computation is performed automatically. Furthermore, transient parameters such as pumping rates for wells can also be assigned independently of model discretization. Transient parameters are entered as a curve of the stress vs. time. When the conceptual model is converted to the numerical model, the transient values of the stresses are automatically assigned to the appropriate stress periods. Since the conceptual model is defined independently of the spatial and temporal discretization of the numerical model, the conceptual model can be quickly and easily changed and a new numerical model can be generated in seconds. This allows the modeler to evaluate numerous alternative conceptual models in the space of time normally required to evaluate one, resulting in a more accurate and efficient modeling process.

A further advantage of storing attributes with feature objects is that the method of applying the boundary conditions to the grid cells reduces some of the instability that is inherent in

finite difference models such as MODFLOW and MT3DMS. When entering individual values for heads and elevations, entering cell values one cell at a time can be tedious. It is also difficult to determine the correct elevation along a river segment at each cell that it crosses. The temptation is to select small groups of cells in series and apply the same values to all of the cells in the group. This results in an extreme stair-step condition that can slow or even prevent convergence of the numerical solver. By using GMS to interpolate values at locations along a linear boundary condition such as a river, it is insured that there will be no abrupt changes from cell to cell-thus minimizing the stair-step effect. It also produces a model with boundary conditions that more accurately represent real world conditions.

Defining Layer Data

An important part of a MODFLOW model is the definition of the layer data (hydraulic conductivity, layer elevations, leakance, etc.). While both the [Grid](#) and [Map](#) module approaches to constructing a MODFLOW model can be used to define the layer data, both approaches may lead to an overly simplistic definition of the stratigraphy. Layers with spatially varying thicknesses can be handled most effectively using a [special set of layer data tools](#) provided in GMS. Solids can also be used to define layer data with the [Solids→MODFLOW](#) and [Solids→HUF](#) commands.

See also

- [Map to MODFLOW](#)
- [Conductance](#)

Activate Cells in Coverage

Once a [grid has been created](#), the next step in converting a [MODFLOW conceptual model](#) to a [numerical model](#) is to inactivate the cells which lie outside the boundary of the conceptual model. This is accomplished by selecting the **Activate Cells in Coverage** command in the [Feature Objects](#) menu. When this command is selected, GMS utilizes the polygons in the coverage that is designated as the model boundary to determine which cells should be active and which cells should be inactive. Each cell is compared with the polygons in the coverage and if the cell does not lie within the interior of any of the polygons, the cell is determined to be outside the domain of the model and is inactivated. Cells inside the model domain are made active.

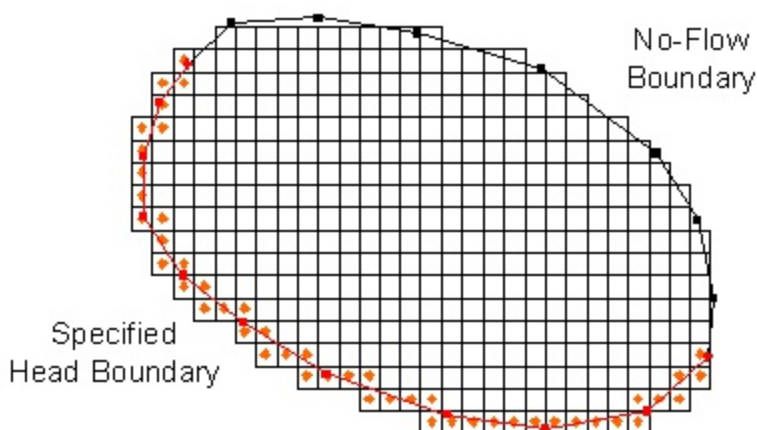

*Sample application of the **Activate Cells in Coverage** command.*

When cells are tested to determine whether they are outside or inside the model domain, if the cell lies partially inside the model domain and partially out, the attribute type of the [feature object](#) on the boundary where the cell is located is used to determine the active/inactive status of the cell. An example of this process is shown in the figure at the right.

If an arc on the boundary of the model domain has no attribute assigned to it, it is assumed to be a no-flow boundary. If a cell is partially covered by a no-flow boundary, the cell is activated if the majority of the cell area is inside the [coverage](#). Conversely, the cell is

inactivated if the majority of the cell area is outside the coverage. As a result, the outer edges of the cells along the no-flow boundary approximately coincide with the no-flow arc. If an arc on the boundary of the model domain has a head dependent attribute assigned to it, a different test is used. Any cell that intersects the arc is designated as active, regardless of what percentage of the cell is inside the model domain. As a result, the centers of the cells along the boundary approximately coincide with the source/sink arc. This is appropriate in this case since the stresses are applied in MODFLOW at the cell centers.

Stress Periods

The computational time intervals for a MODFLOW simulation are called "stress periods". The transient stresses (pumping rates, river stages, etc.) can only change at the beginning of each stress period. Stress periods can be subdivided into smaller time steps, if desired. The **Stress Periods** button in the [Global Options\Basic Package dialog](#) is used to bring up the *Stress Period* dialog. The stress periods should be defined before any of the sources/sinks are entered. If the *Steady State* option in the [Global Options\Basic Package dialog](#) is selected, the **Stress Periods** button is dimmed.

Each stress period is now a single row in the spreadsheet. The stress period properties such as length and number of time steps can now be copied quickly and easily to other stress periods using the spreadsheet interface.



Initialize

A set of stress periods can be defined using the **Initialize** button. The **Initialize** button brings up a dialog which is used to generate a set of stress periods of constant length. The dialog prompts for a number of stress periods, a length, a number of time steps, and a time step multiplier. A set of stress periods is then generated and displayed graphically in the stress period plot.

Stress Period Plot

The horizontal strip at the top of the *Stress Periods* dialog is used to graphically edit stress periods. A stress period can be selected in the plot by clicking on the stress period with the mouse. The values associated with the selected stress period can be edited in the spreadsheet.

Insert Buttons

New stress periods can be added by selecting a stress period and selecting either the **Insert Row**  button or by editing the last row in the spreadsheet. Stress periods can be deleted by selecting the stress periods and selecting the **Remove Row**  button.

Reference Time

The first cell in the spreadsheet is used to enter the reference time for the MODFLOW simulation. The reference time is the date/time corresponding to the beginning of the simulation ($t=0$). If the *Use Date/Times* option is selected in the *Time display* section, all time values entered for transient input data, i.e., time series defined in the [XY Series Editor](#) can be entered in a date/time format rather than a scalar time format. Also, when [post-processing](#), the values shown in the time step selector in the *Data Browser* or at the top of the GMS Window are displayed in the date/time format. Furthermore, any time series curves entered as part of the [MODFLOW conceptual model](#) in the [Map module](#) that were defined using the date/time format will be automatically converted to the proper time scale when the conceptual model is converted to grid-based numerical model.

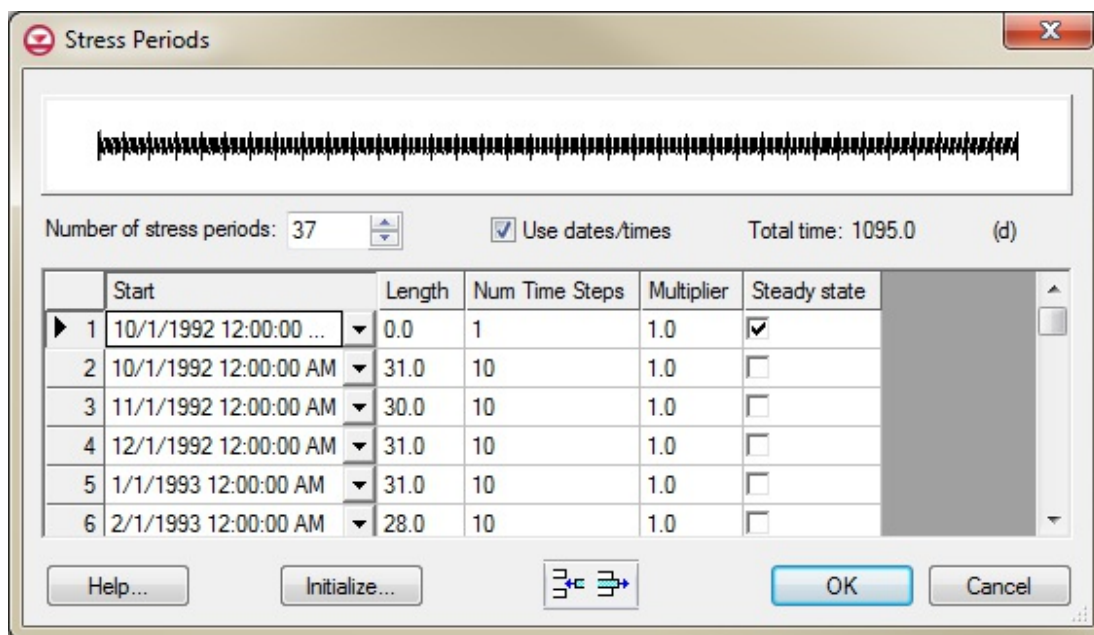

Example of the Stress Period dialog

Map to MODFLOW

After the [conceptual model](#) is constructed and a grid has been created, the final step in converting a conceptual model to a MODFLOW numerical model is to select the **Map** → **MODFLOW** command. However, before this command can be selected, MODFLOW must be initialized. MODFLOW is initialized as follows:

1. Switch to the 3D Grid module
2. Select the **New Simulation** command in the *MODFLOW* menu.
3. MODFLOW simulations are steady state by default. For a transient simulation, go to the [Global Options/Basic Package dialog](#) and select the *Transient* option. Then set up the [stress periods](#) to use in the simulation.
4. By default, the top layer is unconfined and the remaining layers are confined. To use a different set of layer types, go to the BCF/LPF/HUF Package dialog and select the appropriate layer type for each layer.

Once MODFLOW is initialized, the **Map** → **MODFLOW**  command becomes available. When the command is selected, the [Map](#) → [Model](#) dialog appears. Three options are available for converting the conceptual model: *Active coverage only*, *All applicable coverages*, and *All visible coverages*. If the *All applicable coverages* option is chosen, all of the feature objects in all of the MODFLOW-related coverages in the active conceptual model are used. This option is typically selected when the conceptual model is first converted. If the *Active coverage only* or the *All visible coverages* option is selected, only a subset of the coverages are used to update the numerical model.

Temporal Discretization

See the [Temporal Discretization](#) page.

Multiple Values Per Cell

Because GMS processes each feature object separately, there will often be sources/sinks that were derived from two separate feature objects in the same cell. In fact, this is almost always the case in the cell that contains the endpoint of one arc and the beginning point of an adjacent arc. This is not an error. MODFLOW handles each of the boundary conditions in the cell simultaneously.

Specified Head Cells

Because the constant head condition forces the head in those cells to match whatever is specified, it is inappropriate to have other boundary conditions defined in the cells that are designated constant head. Therefore, GMS processes all of the specified head objects first. Afterwards, if there is another stress that should normally be assigned to a cell that has been previously assigned a constant head condition, the new stress is not assigned.

Changing Head Boundary

When mapping a specified head boundary to MODFLOW, GMS always uses the CHD package ([Time Variant Specified Head package](#)). In MF2K, a changing head boundary must be used in order to extract fluxes out of the MODFLOW output for the arcs in the map module. With MF2K, it is not possible to get a flux observation with normal Spec Head. It is assumed that most of the time the user would want to see the flux in/out of the boundary. If a cell contains two different arcs, the specified head is split in 2 pieces at cells where 2 specified head arcs meet. This is done for 2 reasons. First, the CHD package will combine the CHD boundary conditions that are in the same cell. Second, the flux in/out of the cell will be partitioned to the 2 different arcs in the map module.

A traditional specified head boundary can be manually applied by using the IBOUND and starting heads arrays. The computed heads from MODFLOW will be the same whether a constant head or changing head boundary is used.

Well Screens

NOTE: This approach was developed prior to the existence of the MNW package.

The MNW package can more accurately represent a well that crosses multiple MODFLOW layers.

When using well screens in a conceptual model the following equation is used to partition the flow to different layers:

$$Q_i = \frac{T_i}{T} = \frac{(k_h)_i B_i}{\sum_{j=1}^n (k_h)_j B_j}$$

where

Q_i = The flow rate for layer i

$(k_h)_i$ = The horizontal hydraulic conductivity for layer i

B_i = The length of the well screen intercepted by the layer

For example

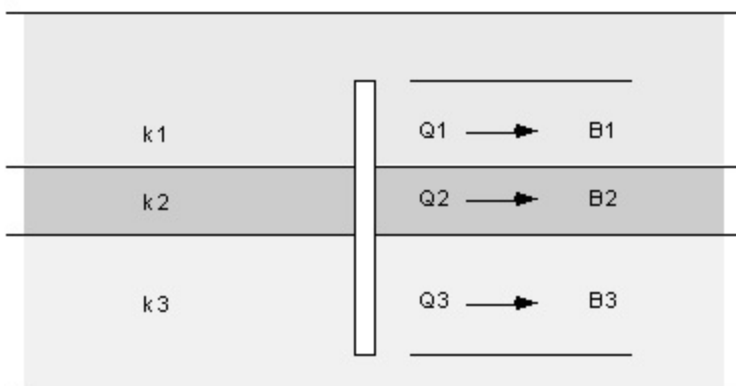

Assuming the K 's are the horizontal K 's, Q_1 would be computed as:

$$Q_1 = \frac{K_1 B_1}{K_1 B_1 + K_2 B_2 + K_3 B_3}$$

In order to complete this computation, the K 's must be assigned to the cells in the grid.

Assign the K values to the grid prior to executing the **Map** → **MODFLOW** command.

If the **HUF** package is being used then the K value for each cell is estimated from the HUF units.

Automatic Layer Assignment

When building a MODFLOW conceptual model with a multi-layer model, it is necessary to define the range of layers associated with a particular source/sink object. In the [Coverage Setup](#) dialog when the "Layer range" option is checked option for assigning cell properties to various layers will appear in the feature object [Attribute Table](#) under the "Auto assign layer" column including "Use layer range", "Auto-assign BC to one cell" and "Auto-assign BC including lower cells". For example, an arc corresponding to a specified head boundary condition may be associated with layers 1-3 on the edge of a model. On the other hand, a drain arc in the middle of the model may only be associated with the top layer. The following example shows how a specified head boundary condition would map with the "Use layer range" option with the range set from 1 to 2:

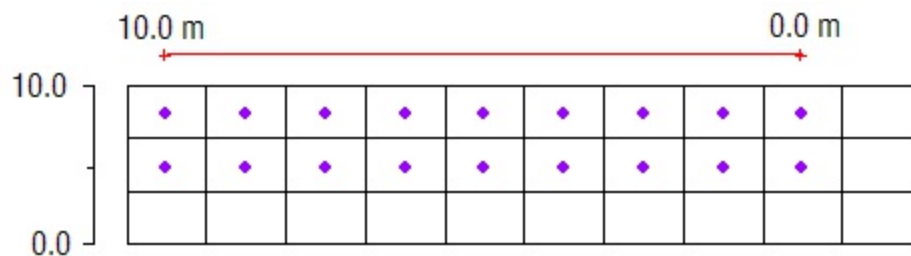

In some cases, however, the proper layer for a particular source/sink object will depend on the elevation of the object relative to the layer elevations. For example, a drain may represent a channel that cuts through the terrain. In some places the channel may be shallow and correspond to layer 1. In other places, the channel may be deep enough that it cuts into layer 2. The "Auto assign to one cell" option is used for defining the layer range in these cases. If this option is selected, the object will be associated with the layer where the elevation or head associated with the object falls between the top and bottom elevation for the layer. The following shows how the same specified head boundary condition would map with the "Auto assign to one cell" option:

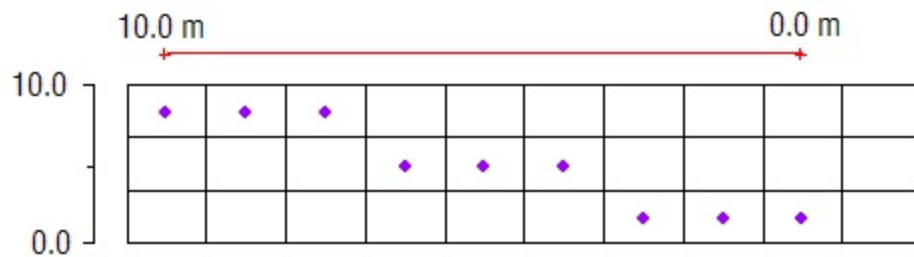

The "Auto-assign including lower cells" option is useful for cases where it's desired to have a specified head boundary assigned to the layer where the head is between the top and bottom elevation of the cell as well as any active cells below that cell. The following shows how the same specified head boundary condition would map with the "Auto-assign including lower cells" options:

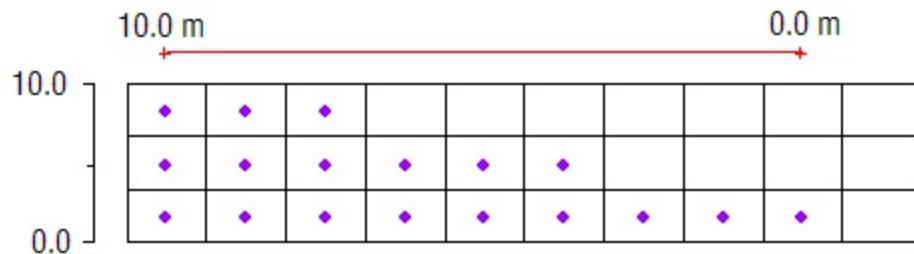

Using TINs

TIN surfaces can be used as part of the conceptual model. See the [Map to MODFLOW with TINs](#) page.

Using Rasters

[Rasters](#) can be used as part of the conceptual model. A raster can be used to assign the head or elevation to a boundary condition instead assigning a constant value. A raster can be associated with a point, arc, or polygon. When the **Map** → **MODFLOW** command is executed and a boundary condition is assigned to a cell, GMS will assign the head/elevation

to the boundary condition using the raster value at the cell center. If the cell center is not within the raster then a warning will be reported and a value of 0.0 is assigned for the head/elevation.

MODFLOW-USG

There are a few unique issues to be aware of when targeting a [UGrid](#) and [MODFLOW-USG](#). The list of features below require that the UGrid be a "stacked grid". A "stacked grid" is one in which there is no vertical sub-discretization of layers and the horizontal discretization of all layers is the same (i.e. the Index of Vertical Sub-Discretization (IVSD) in the UnStructured Grid Discretization (DISU) package could be set to -1).

- Seepage face boundary condition
- Specified flow boundary condition
- [LAK package](#)
- [SUB package](#)

Also, the specified layer option is not supported by Map → MODFLOW with the RCH and EVT packages.

See also

- [MODFLOW Conceptual Model Approach](#)
- [Conductance](#)
- [Map to MODFLOW with TINs](#)

Defining the Layer Elevations

One of the most important steps in defining a [MODFLOW model](#) is to define the layer elevations. The layer elevations are stored in the [Global Options/Basic package](#). The layer elevations include a top elevation for layer 1 and a bottom elevation for all layers. For all layers except for the top layers, the top elevation for the layer is assumed to be equal to the bottom elevation of the layer above.

Define Layer Data

As described above, MODFLOW models can be defined using one of two approaches: (1) by editing the input values on a [cell-by-cell basis](#) directly on the grid, or (2) by creating a high level [conceptual model](#) using the [Map module](#). Both approaches can be used to define the layer elevation arrays. With the grid approach, a constant value can be assigned to the entire array at once or to a set of selected cells. With the conceptual model approach, a set of polygons can be used to define zones of elevations within each layer. While these two approaches are simple to use, in most cases they result in an overly simplistic stair step definition of the layer elevations. In most cases, it is more appropriate to use the [2D geostatistical tools](#) in GMS to smoothly interpolate layer elevations.

Interpolating Elevation Data

The following steps are used to interpolate elevation data:

Step 1: Importing the Scatter Point Elevation Data

The first step in defining MODFLOW layer elevation array data is to create a 2D scatter point set. The set should include a dataset for the top elevation of the top layer and the bottom elevation array of the top layer and each of the underlying layers. A water table elevation corresponding to the desired initial condition (starting head) may also be defined. The simplest way to create such a scatter point set is to create a tabular scatter point file

using a spreadsheet or a text editor. The scatter point file is imported *File | Open* menu command. A sample tabular scatter point file for a three layer model is shown below:

x	y	top1	bot1	bot2	bot3
360	1670	450	345	200	100
290	870	445	340	195	95
480	420	450	350	200	100
620	2120	455	245	200	100
990	1820	470	355	210	115
890	1190	465	350	205	110
1030	710	475	360	215	130
etc.					

Step 2: Interpolating the Elevations to the MODFLOW Arrays

Once the scatter point file is imported to GMS, the next step in defining MODFLOW layer elevation arrays is to interpolate the elevations to the MODFLOW layer elevation arrays. The elevation values can be interpolated directly to the MODFLOW arrays using the **...to MODFLOW Layers** command in the *Interpolation* menu in the 2D Scatter Point module. When this command is selected, the *Interpolate to MODFLOW Layers* dialog appears.

The purpose of this dialog is to associate each of the datasets in the scatter point set with one of the layer data input arrays. A dataset and the corresponding layer data array are selected in the top of the dialog and the **Map** button is selected. The defined relationship is then shown in the bottom of the dialog. Once this is completed for each dataset/layer data array combination, the **OK** button is selected and the scatter point data set values are interpolated directly to the MODFLOW arrays using the currently selected interpolation options.

In some cases, GMS can automatically match the scatter point datasets to the appropriate layer elevation arrays. GMS searches each dataset name to see if "top" or "bot" makes up any portion of the name. If so, it then searches for a number to determine the layer the array should be interpolated to. For example, the dataset names top1, top of layer 1, and top elevation of layer 1 would all automatically map correctly.

It should be noted that the layer data can be set up using multiple scatter point sets. For example, it is possible to have one dense set of scatter points to define the ground surface (top of layer one), and a second, more sparse set of scatter points to define the layer

bottom elevations. In this case, the to Layers command would need to be selected twice, once for each of the scatter point sets.

Step 3: Fixing Layer Interpolation Errors

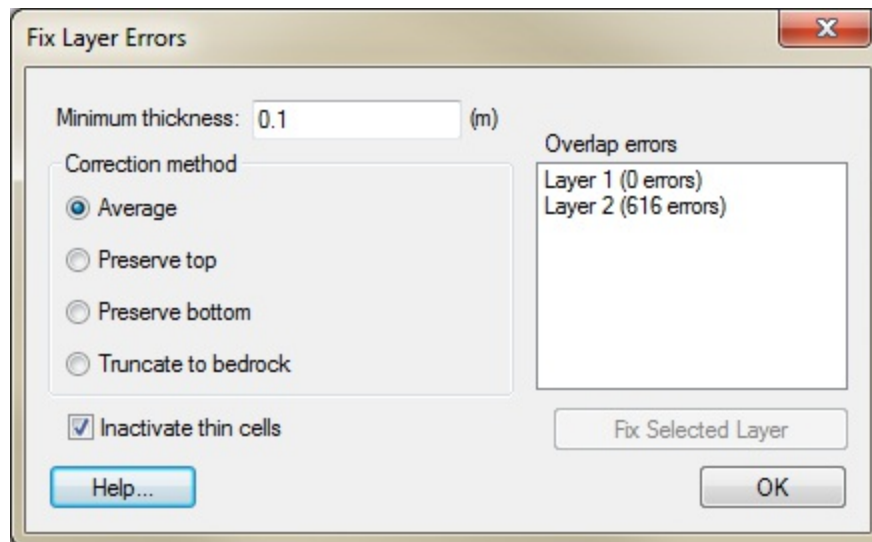

The Fix Layer Errors dialog

When interpolating layer data for the purpose of defining MODFLOW layer elevation arrays, there are often cases where the interpolated values overlap. For example, for some of the cells, the top elevation values for a particular layer may be lower than the bottom values for the layer. In some cases, the best way to fix such a problem is to experiment with the interpolation options or to create some "pseudo-points" to fill in the gaps between sparse scatter points. In other cases, the overlap may correspond to a pinchout or truncation in the layer. In such cases, the elevations need to be adjusted so that there is a small but finite thickness for all cells in the overlapping region.

The first step in fixing layer errors is to use the [Model Checker](#) to determine if elevation overlaps occur. If they do occur, the **Fix Layer Errors** button at the top of the *Model Checker* dialog can be used to bring up the *Fix Layer Errors* dialog. The number of overlap errors for each layer is listed on the right side of the dialog. A layer is highlighted and a correction method is selected on the left side of the dialog. The **Fix Selected Layer** button is then used to adjust the elevations. Four options are available for fixing layer errors:

Average

With the *Average* method, for each cell where an overlap is found, the average elevation at the overlap is computed as

$$\text{ave} = \frac{\text{top} - \text{bottom}}{2}$$

The top and bottom elevations are then adjusted as follows:

$$\text{top} = \text{ave} + \frac{\text{min thickness}}{2}$$

$$\text{bot} = \text{ave} - \frac{\text{min thickness}}{2}$$

This option is useful for modeling the transition zones adjacent to embedded seams.

Preserve Top

With the *Preserve top* method, at each cell, where an overlap is found the top elevation is unchanged and the bottom elevation is adjusted to:

$$\text{bot} = \text{top} - \text{min thickness}$$

This option can be used to model truncated outcroppings.

Preserve Bottom

With the *Preserve bottom* method, at each cell where an overlap is found the bottom elevation is unchanged and the top elevation is adjusted to:

$$\text{top} = \text{bot} + \text{min thickness}$$

Truncate to Bedrock

The *Truncate to bedrock* option differs from the other methods in that it can be used to alter several layers at once. With this method, it is assumed that the bottom elevation values for the bottom layer represent the top of a bedrock unit. The bedrock elevations may overlap several upper elevation arrays. Each cell in the grid is checked and if the bedrock elevation is above the top elevation for the cell, the cell is turned off (made inactive). If the bedrock elevation is below the top elevation and above the bottom elevation for the cell, the bottom elevation for the cell is set equal to the bedrock elevation. If the bedrock elevation is below the bottom of the cell, the cell elevations are unchanged.

Define Layer Data with Solids

Solids can also be used to define layer data for MODFLOW. The **Solids → MODFLOW** and **Solids → HUF** commands in the Solids module set up the layer elevations using the currently defined solids.

Conductance

Many MODFLOW boundary condition types (i.e., general head, rivers, streams, drains) include a conductance parameter. MODFLOW uses the conductance to determine the amount of water that flows in or out of the model due to the boundary condition stresses.

When using a [conceptual model](#), the manner in which the conductance term should be computed and entered depends on whether the feature object is a [polygon](#), [arc](#) or [point](#). Before explaining this fully, a short review of the definition of conductance is appropriate.

Conductance formulation

Darcy's law states:

$$Q = kiA$$

where:

Q = flow rate [L^3/T]

k = hydraulic conductivity [L/T]

i = hydraulic gradient (unitless)

A = gross cross-sectional area of flow [L^2].

Darcy's law can also be expressed as:

$$Q = k \frac{\Delta H}{L} A$$

where:

ΔH = the head loss [L]

L = the length of flow [L]

Since the unknown on the right side is the head, it is convenient to group all of the other terms together and call them conductance:

$$Q = C\Delta H$$

where:

$$C = \text{conductance [L}^2\text{/T]}$$

This results in the following general definition for conductance:

$$C = \frac{k}{L}A$$

This may be represented more specifically in the following form.

$$C = \frac{k}{t}lw$$

where:

t = the thickness of the material in the direction of flow [L]

lw = the cross-sectional area perpendicular to the flow direction [L²].

Conductance in conceptual models

In the case of a river boundary condition, the conductance is defined in MODFLOW as the hydraulic conductivity of the river bed materials divided by the vertical thickness (length of travel based on vertical flow) of the river bed materials, multiplied by the area (width times the length) of the river in the cell. The last term, area, is the hardest parameter to determine by hand since it varies from cell to cell.

Arcs

Fortunately, GMS can automatically calculate the lengths of arcs and areas of polygons. Therefore, when a conductance is entered for an [arc](#), it should be entered in terms of **conductance per unit length**. For example, in the case of rivers, conductance should be entered as:

$$C_{arc} = \frac{\frac{k}{t}lw}{L} = \frac{k}{t}w$$

where:

C_{arc} = conductance per unit length $[(L^2/T)/L]$ or $[L/T]$

t = the thickness of the material $[L]$

w = the width of the material along the length of the arc $[L]$

When GMS applies the boundary condition from the arc to the grid cell, it automatically multiplies the entered value of conductance by the length of the arc that intersects the cell to create an accurate conductance value for the cell.

Polygons

For [polygons](#), conductance should be entered in a *conductance per unit area* form:

$$C_{poly} = \frac{\frac{k}{t}lw}{A} = \frac{k}{t}$$

where:

C_{poly} = conductance per unit area $[(L^2/T)/L^2]$ or $[1/T]$

t = the thickness of the material $[L]$

When GMS converts the stress from a polygon to a grid cell, it automatically multiplies the entered value of conductance by the area of the cell that is covered by the polygon to create an appropriate conductance value for the cell. This restores the dimensional accuracy to the expression for conductance.

Points

When a general head, river, stream or drain attribute is assigned to an individual point, the conductance should be entered as a normal conductance value. This conductance is then directly assigned to the cell containing the point.

Parameter Factors

Beginning with GMS version 7.0, the Well, Drain, River, General head, and Stream boundary conditions have a parameter factor field that is associated with each boundary

condition. The parameter factor is used with the parameter value to compute the final value of conductance for a given boundary condition (or in the case of the well package the final Q value). The parameter factor is automatically set by GMS when doing the **Map**→**MODFLOW** command. This value will be set to the length of the arc in the cell or the area of the polygon in the cell associated with the boundary condition; for a point feature the factor is set to 1.0.

See also

- [Map to MODFLOW](#)
- [MODFLOW Conceptual Model Approach](#)

Output Control

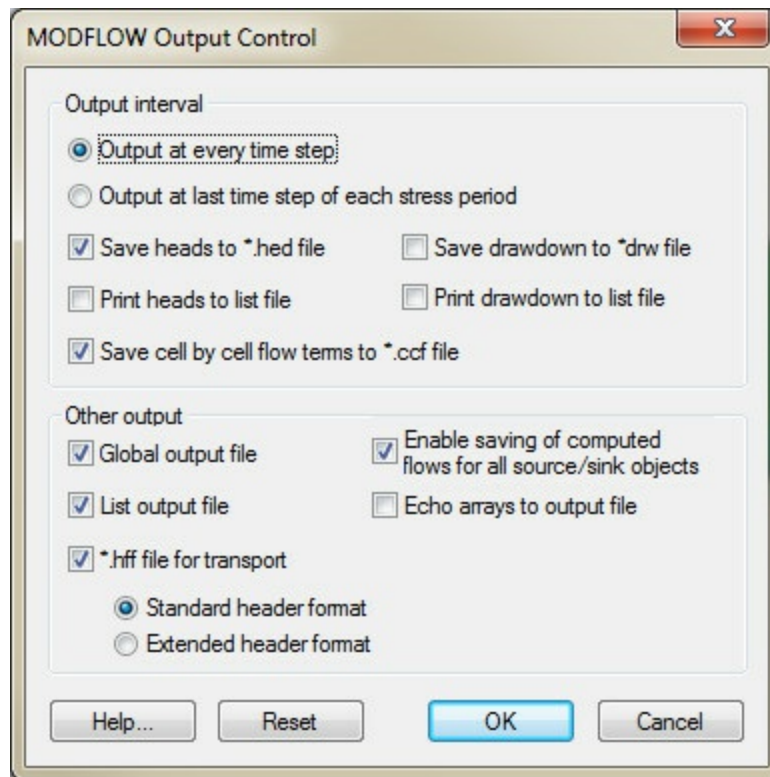

The MODFLOW Output Control Dialog.

The *Output Control* dialog is accessed from the *MODFLOW* menu. The *Output Control* dialog contains the following options:

Output Interval Options

The *Output Interval* section allows choosing which files to output and when to output the results. By default, GMS instructs MODFLOW to output heads and volume data to both data files and text output files. Drawdown is not output by default.

Other Output Options

Global Output File

Choose this option to use the global output file (*.glo). This file contains information about the input files and, during an inverse run using the PES process, will contain

information about each iteration. Either the global file, list file, or both must be used with MODFLOW.

List Output File

Choose this option to use the list output file (*.out). This file contains information about the current MODFLOW run. This file will be overwritten during an inverse run using the PES process for each inverse iteration.

***.hff File For Transport**

Select this option to output the head and flow file (*.hff) used by MT3DMS to generate the flow fields for transport modeling.

Save Arrays Using Binary Files

Choose this option to save all 2D arrays used as MODFLOW input as binary arrays in external files. If this option is not selected, the 2D arrays are written within the respective files in ASCII format. The binary option results in more files, but uses less disk space. There is also a time savings during running for MODFLOW models with large grids.

Enable saving of computed flows for all source/sink objects

This option allows GMS to create a flow observation for all sources/sinks that were created using the **Map→MODFLOW** command so that the user can see the computed flux through the group of boundary conditions. If the user is doing a transient simulation then having this option may cause MODFLOW to crash because MODFLOW attempts to allocate more memory than any of us have available. Turning off this option in this situation is the best course of action.

Importing MODFLOW Files

GMS imports standard MODFLOW 88, 96, 2000, 2005, MODFLOW-NWT, MODFLOW-LGR, and MODFLOW-USG files. GMS supports saving of MODFLOW 2000, 2005, and MODFLOW-NWT so other versions will be converted to MODFLOW 2000, 2005, or NWT. MODFLOW 88 and 96 files will be automatically translated when imported, and will not use the [MODFLOW Translator dialog](#).

If GMS created the MODFLOW simulation then open the corresponding GMS project file (*.gpr). If there is no GMS project file, import the MODFLOW simulation into GMS as described below. GMS will create a new copy of the imported MODFLOW simulation in its own modified MODFLOW file format. See [MODFLOW with HDF5](#) for more information on the modified MODFLOW file format.

Native MODFLOW files (ascii/text) can be exported from GMS. See [Exporting Native MODFLOW Files](#) for more information on exporting MODFLOW files.

How to import a MODFLOW model into GMS

Follow these steps when importing a MODFLOW simulation into GMS.

1. Were the MODFLOW files created by GMS?

- o Yes

If the files were created by GMS, and the user has the GMS project file (.gpr), read that into GMS using the standard *File | Open* command. If the user doesn't have the *.gpr file, import the MODFLOW model into GMS by opening the "super file" (*.mfs) using the standard *File | Open* command. The super file is a non-standard file that GMS creates along with the standard MODFLOW files. If the user doesn't have a super file, proceed to step 2 below.

- o No

Proceed to step 2 below.

- o Don't know

If the user has a *.gpr file or a *.mfs file, then it's almost certain that the files were created by GMS. If the user doesn't have these files, proceed to step 2 below.

2. Determine whether the model is MODFLOW 88, 96 or 2000. If unsure, refer to the section below entitled [Determining the MODFLOW version](#) which describes each one.

- MODFLOW 88

Read the basic package file into GMS (using the standard *File* | **Open** dialog). GMS will attempt to import all the other files.

- MODFLOW 96

Read the name file.

- MODFLOW 2000

Read the name file.

- MODFLOW 2005

Read the name file.

- MODFLOW-NWT

Read the name file.

- MODFLOW-LGR

Read the *.lgr file.

- MODFLOW-USG

Read the name file. Note: For GMS to import the native MODFLOW-USG files a [*.gsf file](#) (Grid Specification File) or a *.vtu file (VTK unstructured grid file) must exist to define the grid used with the MODFLOW simulation because the native MODFLOW-USG files do not include locations of the grid nodes, [unfortunately](#).

MODFLOW Translator dialog



The MODFLOW Translator dialog.

When importing a MODFLOW file into GMS, the *MODFLOW Translator* dialog may appear. If the MODFLOW file was not created in GMS 6.5 or later, the file must be translated into a format fully compatible with all of GMS' features and tools. GMS copies the file before performing the translation, so the original file is not changed by this translation process.

Select from the list of MODFLOW version so the translator knows how to interpret the file. The versions currently supported within the dialog are:

- MODFLOW 2000
- MODFLOW 2005
- MODFLOW-NWT
- MODFLOW-LGR
- MODFLOW-USG

Troubleshooting

If having trouble reading the files into GMS, first verify that MODFLOW can read the files by launching MODFLOW at a command prompt and giving it the name of the file to read. If MODFLOW can read the files but GMS cannot, it may be because the package is not support by GMS; see [MODFLOW Packages Supported in GMS](#) for more information.

Contact [tech support](#) for additional help.

Determining the MODFLOW version

MODFLOW 88

To tell if a file is MODFLOW 88 open up the basic package file as a text file. GMS uses *.bas as the extension for this file. The file should appear something like the figure below.

Heading 1

Heading 2

```
          3          23          17          1          4
11 13 14 15  0  0 16  0  0  0  0 10 12  0  0  0  0  0  0  0  0 29  0  0
          0          0
          1          1          (17I3)          0
 1  1  1  1  1  1  1  1  1  1  1  1  1  1  1  1  1
 1  1  1  1  1  1  1  1  1  1  1  1  1  1  1  1
 1  1  1  1  1  1  1  1  1  1  1  1  1  1  1  1
 1  1  1  1  1  1  1  1  1  1  1  1  1  1  1  1
```

For a MODFLOW 88 file the third line of the basic package file will include an IUNIT array with 24 slots. There may also be an IUNIT array with only 12 slots, if so just ok the warning GMS gives. These slots include the unit numbers for packages included in the file. Every number must be unique to its package. If the number does not correspond to a file then the file is an external array which must be matched by the user. If the basic package file includes an IUNIT array as described it is a MODFLOW 88 file.

To import the MODFLOW 88 file locate the *.mfs file. If there is no *.mfs file then select the *.bas file. Then simply use the *File* | **Open** command to read the file into GMS.

More about MODFLOW 88 files

MODFLOW 88 files have no name (*.nam or *.mfn) file.

GMS makes a few assumptions when reading in MODFLOW 88 files:

1. All files must have the same prefix.

- Example: If the files are named bas.dat, drain.dat, and river.dat they all must be converted to run1.bas, run1.drn, and run1.riv
2. All files use the standard GMS suffixes as shown in the table below.
 - If these are not the suffixes in use, the user will need to rename the files.
 3. IUNIT slots must be standard with standard ID #'s according to MODFLOW documentation.
 4. It is up to the user to know what external arrays go to which MODFLOW files. Otherwise the files will not be properly read in.
 - GMS can import external arrays but is unable to import external binary arrays
 5. MODFLOW 88 files use a fixed format.

MODFLOW 88 IUNIT Array Positions and Packages

1	2	3	4	5	6	7	8	9	10	11	12	13	14	15	16	17	18	19	20
BCF	WEL	DRN	RV	EVT	GHB	RCH	SIP	DE4	SOR	OC	PCG	GFD		HFB	RES	STR	IBS	CHD	

Standard GMS Extensions for MODFLOW 88 files

Package	Extension
BASIC	*.bas
OUTPUT CONTROL	*.oc
BCF	*.bcf
RIVER	*.riv
DRAIN	*.drn
WELL	*.wel
GENERAL HEAD BOUNDARY	*.ghb
STREAM	*.str
RECHARGE	*.rch
EVAPOTRANSPIRATION	*.evt
STRONGLY IMPLICIT PROCEDURE	*.sip
SLICE-SUCCESSIVE OVERRELAXATION	*.sor

MODFLOW 96

To tell if model files are in MODFLOW 96 format, open up the basic package file as a text file. For a MODFLOW 96 file the third line of the *.bas file will NOT include an IUNIT array. Instead the third line will say FREE, which means that the data in the file is in free format and each data entry is separated with a space. A 96 file may not contain the FREE line. Instead the line may be blank and the file may be fixed format. This file can be read in just the same using the name file.

Heading 2

3 23 17 1 4

FREE

0 0

INTERNAL 1 (free) 0 "Ibound Layer 1"

1 1 1 1 1 1 1 1 1 1 1 1 1 1 1 1 1 1

1 1 1 1 1 1 1 1 1 1 1 1 1 1 1 1 1 1

1 1 1 1 1 1 1 1 1 1 1 1 1 1 1 1 1 1

If the basic package file says FREE as described it is a MODFLOW 96 file. A name file (typically with a *.mfn or *.nam extension) should also exist. If one does not it must be created as described below.

To open a MODFLOW 96 file locate the name file and use the *File* | **Open** command to read the file into GMS.

More about MODFLOW 96 files

MODFLOW 96 files use a name file to identify the packages files. This replaces the IUNIT array used in MODFLOW 88. The advantage of it is that the files do not need to all have the same prefix in their name. The name file is laid out as shown below. In the first column the card name is given (see MODFLOW documentation for more information). In the second column the IUNIT number is given. This number must be unique from all other numbers. The third column gives the file name and as stated does not need to have the same prefix for every package.

Sample *.mfn file:

LIST 26 "run1.out"

BAS 1 "run1.bas"

BCF 11 "run1.bcf"

OC 10 "run1.oc"

DATA (BINARY) 30 "run1.hed"

DATA (BINARY) 40 "run140.ccf"

PCG 12 "run1.pcg"

RIV 15 "run1.riv"

WEL 13 "run1.wel"

RCH 20 "run1.rch"

MODFLOW 2000, 2005, & MODFLOW-NWT

Like the MODFLOW 96 files, MODFLOW 2000, 2005 and MODFLOW-NWT use name files rather than an IUNIT array. To know if a file is a MODFLOW 2000, 2005, or MODFLOW-NWT file look for a discretization file (*.dis). If a *.dis file exists then it is a 2000, 2005 or NWT model (though it may not specify), so the *File | Open* command is used and the name file (*.nam or *.mfn) is selected and read into GMS.

Sample *.mfn file:

```
# MF2K NAME file
#
# Output Files
GLOBAL 1 "easttex.glo"
LIST 2 "easttex.out"
DATA(BINARY) 30 "easttex.hed"
DATA(BINARY) 40 "easttex.ccf"
LMT6 18 "easttex.lmt"
#
# Obs-Sen-Pes Process Input Files
OBS 50 "easttex.obs"
DROB 54 "easttex.drob"
CHOB 55 "easttex.chob"
ASP 71 "easttex.asp"
#
# Global Input Files
DIS 19 "easttex.dis"
#
# Flow Process Input Files
BAS6 3 "easttex.ba6"
LPF 4 "easttex.lpf"
OC 15 "easttex.oc"
RCH 16 "easttex.rch"
WEL 9 "easttex.wel"
DRN 10 "easttex.drn"
```

CHD 13 "easttex.chd"

PCG 14 "easttex.pcg"

Changes in GMS 7.0

When GMS 7.0 or later reads a MODFLOW simulation it checks if the simulation files are in the modified GMS format. MODFLOW files created by GMS 6.5 or a later use this format. If the simulation is not in the GMS format then GMS converts it into this format.

In versions of GMS prior to 7.0, GMS would read the MODFLOW files and do the conversion. Starting with version 7.0, GMS uses a modified version of MODFLOW to read the input files and do the conversion. GMS then reads the converted files. By using MODFLOW to read MODFLOW files and do the conversion, GMS can read whatever MODFLOW can read. Conversely, if GMS cannot read it, MODFLOW probably can't either.

Conversion Steps

Depending on the version of the model, GMS will perform all or some of the following steps to convert the model into the standard GMS format.

1. **Convert MODFLOW 88 to MODFLOW 96.** If importing a MODFLOW 88 model, GMS creates a MODFLOW 96 Name file by examining the Basic package file or the GMS super file. The name file is put in the same directory where the Basic package file or super file is found. In creating the MODFLOW 96 name file, GMS assumes the unit numbers in the IUNIT array in the Basic package file are ordered according to the standard MODFLOW 88 order (as found in the MODFLOW 88 source code). GMS uses the lowest unit number not used in the IUNIT array for the List file added to the name file. If external arrays are being used, the unit number GMS uses for the List file may be the same as one used for an external array.
2. **Convert MODFLOW 96 to MODFLOW 2000.** After creating the MODFLOW 96 Name file, GMS calls mf96to2k.exe, a USGS program distributed with MODFLOW 2000 which converts MODFLOW 96 models to MODFLOW 2000. This creates some new files in the same directory as the basic package file: name_MF2k.bas, name_MF2K.bcf, and name_MF2K.nam (where "name" is the name of the MODFLOW

96 name file).

3. **Translate MODFLOW 2000 to GMS H5 Format.** GMS then calls the MODFLOW Translator to translate the simulation into GMS H5 format. This creates an H5 file in the temp directory. The user must save the GMS project in order to have a GMS H5 formatted MODFLOW simulation on disk, otherwise the temp file will be discarded.

mf96to2k

Some modifications were made to mf96to2k.exe with regards to layer elevations and confining beds so that the program could be run in a non-interactive batch mode.

Grid Elevations

When mf96to2k.exe converts a MODFLOW 88/96 simulation to a MODFLOW 2000 simulation the program creates a discretization file (DIS). This file defines the layer elevations for the model grid as well as the stress periods. In MODFLOW 88/96 a model could be defined without the need for explicitly defining the top and bottom elevations of the model grid. If the old model has grid elevations defined in the BCF file then those elevations are preserved in the new MODFLOW 2000 DIS file. Where elevations are not defined in the old model then mf96to2k.exe would prompt the user to enter a constant elevation for the particular layer. When mf96to2k.exe is run by GMS these layer values are automatically set. After the model is read into GMS the user may need to edit these values.

Layer Confining Beds (LAYCBD)

When mf96to2k.exe converts a MODFLOW 88/96 model it also asks the user if a layer confining bed exists beneath each of the grid layers. When mf96to2k.exe is run by GMS no confining beds will be defined beneath the model layer. If the user wishes to include confining beds these can be edited in the *Global/Basic* dialog under the *MODFLOW* menu.

Unsupported Packages

When a simulation with unsupported package files is imported into GMS the associated package file is copied from the old simulation folder to the new project simulation folder. Once imported into GMS unsupported package files can be edited or removed using the

[Name File dialog](#). If there are associated package files that contain package data using the *EXTERNAL* or *OPEN/CLOSE* keywords, they will need to be manually copied to the project's MODFLOW folder once the project is saved.

Files Generated by Other Software

Other software such as Groundwater Vistas, Visual MODFLOW, and PM Win use their own file formats. However they do write out native MODFLOW files which GMS can read in. To use them make sure that the other software is saving out the files properly and then follow the steps above for the proper version of MODFLOW files.

Groundwater Vistas

To export MODFLOW files from Groundwater Vistas:

1. Open the simulation in Groundwater Vistas
 1. Select *File* | **Open**
 2. Navigate to and select the “*.gww” file, then select “Open”
2. Export the native MODFLOW files from Groundwater Vistas
 1. Select *Model* | *MODFLOW (or MODFLOW 2000)* | **Create Datasets**
3. Import the name file into GMS
 1. Select *File* | **Open**, the **Open** macro, or just drag and drop the *.nam file in the GMS main screen.

PM Win

1. Select *Models* | *MODFLOW* | **Run**
2. Prior to MODFLOW running the model inputs will be generated.

Visual MODFLOW

Visual MODFLOW files can not be read into GMS. To use Visual MODFLOW files, the user will need to run MODFLOW from within Visual MODFLOW, and then modify the *.mfi file. See below for details.

1. Run MODFLOW from Visual MODFLOW

1. Open the Visual MODFLOW project (vmf file if using the latest version of Visual MODFLOW) in Visual MODFLOW
2. Select **Run** in the top menu
3. Select **Run** again from the top menu
4. Select *MODFLOW 2000* in the *Engines to Run* dialog, then select *Translate & Run*
5. Select the **Close** button in the *VMEngine* window when the model is finished running

2. Modify and rename the “*.mfi” file

1. Go to the directory where the simulation is saved on the computer
2. Create a copy of the “*.mfi” file. Change the extension of the copy to “*.mfn”
3. Open the *.mfn file in a text editor
4. Comment out packages that are not supported by the USGS release of MODFLOW (for example, the “WHS” and “NDC” lines)^
5. If necessary, modify the directory that each MODFLOW file is referencing. This is necessary if the Visual MODFLOW files were not created on the computer being used
6. Save the *.mfn file

3. Open the *.mfn file in GMS

1. Select *File | Open*, the **Open** macro, or just drag and drop the *.mfn file in the GMS main screen
2. The *MODFLOW Translator* will most likely appear. Select **OK** after selecting the appropriate version of MODFLOW
3. Select “Done” when the *MODFLOW Translator* is finished
4. A dialog will appear saying that a supported solver was not found in the name file and that the PCG solver has been added. This is because the solver that Visual MODFLOW uses is not compatible with the USGS version of MODFLOW, and so GMS does not use it either. Select **OK**

^Note: to comment out a package, place a pound/number sign in front of a line. See the [Online Guide to MODFLOW](#) for packages that the USGS version of MODFLOW supports.

USGS MODFLOW Documentation

Here are some links to MODFLOW documentation that may be helpful.

MODFLOW 88	MODFLOW 88 (I) , MODFLOW 88 (II)
MODFLOW 96	MODFLOW 96 (I) , MODFLOW 96 (II)
MODFLOW 2000	MF2K Flow , MF2K Obs-Sen-Pes , HUF , LMG , LMT , MF2K Calibration
MODFLOW 2005	MF2005 Flow Process
MODFLOW-NWT	MODFLOW-NWT , A Newton Formulation for MODFLOW-2005
MODFLOW-LGR	MODFLOW-LGR , MODFLOW-LGR Multiple Refined Areas , MODFLOW-LGR with SFR
MODFLOW-USG	MODFLOW-USG , MODFLOW-USG I/O , ZONBUDUSG

MODFLOW with HDF5

The versions of MODFLOW 2000, MODFLOW 2005, SEAWAT, MODFLOW-NWT, and MODFLOW-LGR that ship with the GMS software have been modified to be able to read input data stored in HDF5 files. GMS saves some MODFLOW data to an HDF5 file that is saved with the other MODFLOW files. Some MODFLOW files will have references to the HDF5 file.

Advantages to HDF5

The HDF5 file format is a cross platform binary format for storing scientific data. One advantage of using HDF5 is that the data is stored in binary format so the disk reads and writes are much faster than with ASCII files. View the data stored in an HDF5 file by using [HDFView](#) (or some other available viewer).

Another advantage of using the HDF5 library with MODFLOW package data and array data is that HDF5 will compress the data. For example, if there is a transient simulation using the river package the typical line in a river package file would look like this:

[K] [I] [J] [STAGE] [CONDUCTANCE] [ELEVATION]

1 3 4 10.2 5.8 9.5

Then during the next stress period typically the stage would change. The line in the file would look like this:

1 3 4 10.8 5.8 9.5

So we repeated all of the data except that 10.2 changed to 10.8. With compression those repeated values do not take up much space on disk so that the resulting file is smaller.

In one example a river file that was 437 MB was saved to HDF5 format with a compression level of 1; the resulting file was 14 MB. In another example an HDF5 file that contained drain and general head data was 8 MB while the drain file was 253 MB and the general head 141 MB. Not only do the files compress extremely well but the read/write times for the

HDF5 file are much faster than the ASCII files.

Changes to MODFLOW 2000 & 2005 code

The following subroutines in ult6.f were modified: U2DREL, U2DINT, and ULSTRD. The stream package reading routines were also modified in the str6.f file.

ult.f modifications

U2DREL and U2DINT were modified so that if the key word HDF5 was encountered when attempting to read an array then an external procedure is called to read in the data. We have added support for the following:

Explanation of variables

	Explanation of variables
HDF5	a card to indicate that this is read from an HDF5 file
CNSTNT	the multiplier for the array
IPRN	print flag for the output control for MODFLOW
"FNAME"	the HDF5 file where the array is stored
"pathInFile"	path to the dataset in the HDF5 file
nDim	number of dimensions that the dataset has (this is 1, 2, 3)
start1	the index (NOTE: these are 0 based not 1) for the starting point to read the dataset in the first dimension
nToRead1	the number of values to read in the first dimension
start2	the index for the starting point to read the dataset in the second dimension
nToRead2	the number of values to read in the second dimension
start3	the index for the starting point to read the dataset in the third dimension
nToRead3	the number of values to read in the third dimension

example: "HDF5 1.0 0 "input.h5" "Recharge/07. Property" 3 0 1 0 132 0 1"

This type of formatting will work for any HDF5 dataset that has 3 dimensions or less and the dataset can be a 4 byte float or an 8 byte double. The other available format that can be used with the HDF5 key word for the array reading utilities is the following:

HDF5 CONSTANT CNSTNT

example: HDF5 CONSTANT 3.0

This type of formatting will assign a constant value to the array. This type of formatting may seem unnecessary. However, the constant identifier can be useful when using parameters to define arrays. Parameters will be explained in another section.

ULSTRD was also modified to read data from an HDF5 file. This format is specific to the

types of HDF5 files that GMS creates.

GMS_HDF5_01 "FNAME" "pathInFile" SP

Explanation of variables

GMS_HDF5_01	a card to indicate that this is read from an HDF5 file
"FNAME"	the HDF5 file where the array is stored
"pathInFile"	path to the group in the HDF5 file where all of the data for the boundary condition is stored
SP	stress period number

Here is an example of a regular modflow drain file and a drain file with the HDF5 modifications.

Comparison of MODFLOW Drain files

Traditional Drain file	Drain file with HDF5
3 40 AUX IFACE AUX CONDFACT AUX CELLGRP	#GMS_HDF5_01
3 0	3 40 AUX IFACE AUX CONDFACT AUX CELLGRP
1 3 2 19.0 10.0 6 1.0 -1	3 0 0
1 4 3 19.0 10.0 4 1.0 -1	GMS_HDF5_01 "sg_t_pest_65.h5" "Drain" 1
1 5 4 19.0 10.0 5 1.0 -1	3 0 0
3 0	GMS_HDF5_01 "sg_t_pest_65.h5" "Drain" 2
1 3 2 18.9 11.0 6 1.0 -1	3 0 0
1 4 3 18.9 11.0 4 1.0 -1	GMS_HDF5_01 "sg_t_pest_65.h5" "Drain" 3
1 5 4 18.9 11.0 5 1.0 -1	
3 0	
1 3 2 19.0 10.0 6 1.0 -1	
1 4 3 19.0 10.0 4 1.0 -1	
1 5 4 19.0 10.0 5 1.0 -1	

str6.f modifications

Since the STR package does not use the ULSTRD utility the str6.f file had to be modified to read the same data that ULSTRD was modified to read: **GMS_HDF5_01 "FNAME" "pathInFile" SP**.

Parameters

MODFLOW 2000 introduced the concept of parameters as native input to MODFLOW. Starting with version 6.5, GMS no longer writes out native MODFLOW parameters (except when clusters are defined) and the use of the MODFLOW PES process is not available from within GMS. Even when native MODFLOW files are exported from GMS, native MODFLOW parameters are not used (except when clusters are defined) and instead the parameter starting values are written. However, GMS still supports [PEST](#) and users may create parameters in the GMS interface as they have been able to do previously. Parameters are created in GMS by assigning a "key" value (usually a negative number) to a

MODFLOW input. When MODFLOW is running and calls our external routine to read in the HDF5 a check is made in the data that is read from the HDF5 file. If one of the parameter "key" values is found in the data then the parameter value is substituted into the array or list.

By adopting this approach it was much easier to support transient parameters and very large sets of pilot points.

Also, adopting this approach allows GMS users to use parameters with the BCF package. This feature is not available with the MODFLOW PES process.

Pilot Points

In previous versions of GMS, [pilot points](#) were supported by using the multiplier arrays in MODFLOW. Beginning with version 6.5 the pilot point interpolation takes place within our external routine that is called by MODFLOW. For example, if MODFLOW calls our routine to read an HK array and that array has parameter *key* values that are associated with a parameter that is defined using pilot points then our routine will perform the pilot point interpolation and substitute the appropriate value. This includes any log interpolation that the user has specified.

Reading MODFLOW files which include HDF5 data

When GMS writes out the MODFLOW files for the list based packages, the first item written to the file is #GMS_HDF5_01. When GMS reads these MODFLOW files with this special comment, it does not read any more of the package file and the data from the *.h5 file will be used.

When GMS saves the RCH or EVT package with parameter that are defined with cluster (and instances). Then a different special comment is written to the top of the file: #GMS_PARAM_CLUSTERS. If GMS is reading a project file that includes a MODFLOW simulation then when this special comment is encountered GMS will not read any more of the package file. However, if a user is reading a MODFLOW model (not a project file) then the rest of this package file will be read and new datasets will be created on the 3D grid

that are used to define the clusters used by the parameters.

Exporting Native MODFLOW Files

To export native MODFLOW ASCII files from GMS 6.5 up to GMS 9.2, use the following steps:

1. Open a project in GMS (6.5 or later).
2. In the 3D Grid Module, select *MODFLOW* | **Export Native MF2K text...** (GMS 8.3 and below) or *MODFLOW* | *Advanced* | **Export Native MF2K text...** (GMS 9.0 and above).
3. In the window that appears, double-click the Name file of the MODFLOW model that the user wants to convert to ASCII format.
4. A DOS prompt will appear. Press the *Enter* key when the executable is finished.
5. A folder called "Out_Mf2k" is created in the same folder as the name file the user selected. "Out_Mf2k" contains all the MODFLOW input files in ASCII format.

If the DOS prompt does not appear after selecting the name file, then go to *Edit* | **Preferences...** and select *Models*. Verify that the *Gms2Mf2k* executable (the application that converts MODFLOW files from HDF5 to ASCII format) has the correct path next to it. If it doesn't, select **Browse...** and locate the executable. It will probably be located at *C:\Program Files\GMS 8.1\models\mf2k\Gms2Mf2k.exe*.

If not using MODFLOW-USG then to export native MODFLOW ASCII files from GMS 10.0 (or later) use the following steps:

1. Open the project in GMS
2. Select the *MODFLOW* | **Global Options** menu command.
3. Under the *MODFLOW version* section of the dialog turn on the *Save native text copy* option.
4. Save the project.

When a GMS project is saved with a MODFLOW model there will be a project file (ex: myProject.gpr) and a MODFLOW folder (ex: myProject_MODFLOW). With the *Save native text copy* option turned on another folder is created (ex: myProject_MODFLOW_text) that contains the MODFLOW files in native text format.

External links

- More information about [HDF5](#)

MODFLOW Name File Dialog

The *MODFLOW Name File* dialog, accessed using the **Name File** command under the *MODFLOW* menu, shows the files read and written when running a MODFLOW simulation. It allows the unit numbers to be edited, and unsupported packages to be edited and removed from the simulation. Unsupported packages listed in the dialog will be included when running the simulation.

The text file for an unsupported package can be edited by clicking on the **Edit** button in the *Edit Unsupported* column. This will bring up the *View Data File* dialog or the text editor of choice where the selected package file can be manually edited.

An unsupported package can be removed by selecting the row for the unsupported package and clicking on the **Remove** button.

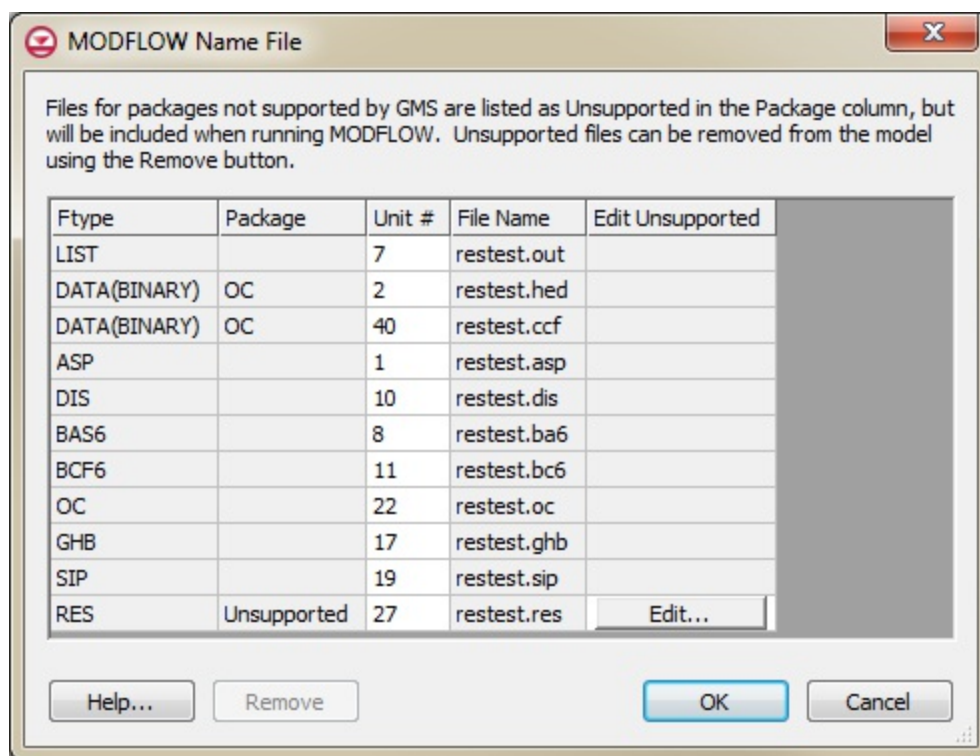

The MODFLOW Name File dialog.

Unsupported MODFLOW Features

MODFLOW Versions

GMS supports all standard MODFLOW versions. For a list of input files and packages supported in each version see [here](#)

- [MODFLOW 88](#) (import only)
- [MODFLOW 96](#) (import only)
- [MODFLOW 2000](#)
- [MODFLOW 2005](#)
- [MODFLOW-NWT](#)
- [MODFLOW-LGR](#)
- [MODFLOW-USG](#)

The unsupported MODFLOW versions include:

- MF2K-GWM
- MF2K-VSF
- MF2K-FMP

Processes

Beginning with GMS 6.5 the following processes are not supported:

- PES (This process is not needed since GMS uses PEST for parameter estimation)
- SEN (This process is not needed since GMS uses PEST for parameter estimation)

Packages

- See [Packages Supported in GMS](#). All other packages are unsupported (but we are always working on adding support for more packages). For any package not currently supported in GMS, the file associated with that package will be ignored when the model is imported. However, GMS keeps track of unsupported packages it encounters when reading the name file and, when the project is saved, GMS lists the unsupported packages in the name file and copies the unsupported package files from the old directory to the new directory. Unsupported package files can be edited and removed using the [Name File dialog](#).

Options

The following MODFLOW options are not supported:

- XSECTION
 - GMS does not support models that use the XSECTION option on line 1 of the BA6 file.
- Quasi-3D confining bed (GMS 6.5.x and before)
- File formats: GMS 6.5.x (and earlier versions) can read most regularly formatted files but MODFLOW supports more formatting options than GMS does. Beginning with version 7.0, MODFLOW is used to import non-GMS MODFLOW simulations (thus, all MODFLOW formats can be imported).

Parameters

MODFLOW 2000 introduced the concept of parameters as native input to MODFLOW. Starting with version 6.5, GMS no longer writes out native MODFLOW parameters (except when clusters are defined) and the use of the MODFLOW PES process is not available from within GMS. Even when native MODFLOW files are exported from GMS, native MODFLOW parameters are not used (except when clusters are defined) and instead the parameter starting values are written. However, GMS still supports [PEST](#) and users may create parameters in the GMS interface as they have been able to do previously.

Parameters are created in GMS by assigning a "key" value (usually a negative number) to a MODFLOW input. When MODFLOW is running and calls our external routine to read in the HDF5 a check is made in the data that is read from the HDF5 file. If one of the parameter "key" values is found in the data then the parameter value is substituted into the array or list.

By adopting this approach it was much easier to support transient parameters and very large sets of pilot points.

Also, adopting this approach allows GMS users to use parameters with the BCF package. This feature is not available with the MODFLOW PES process.

Other unsupported parameter options:

- HFB, SFR (GMS 7.0.x and before)
- STR, CHD (GMS 6.5.x and before)
- Multiple clusters for array based parameters (GMS 6.5.x and before)
- Parameter Instances (GMS 6.5.x and before)

Interpolate to MODFLOW Layers

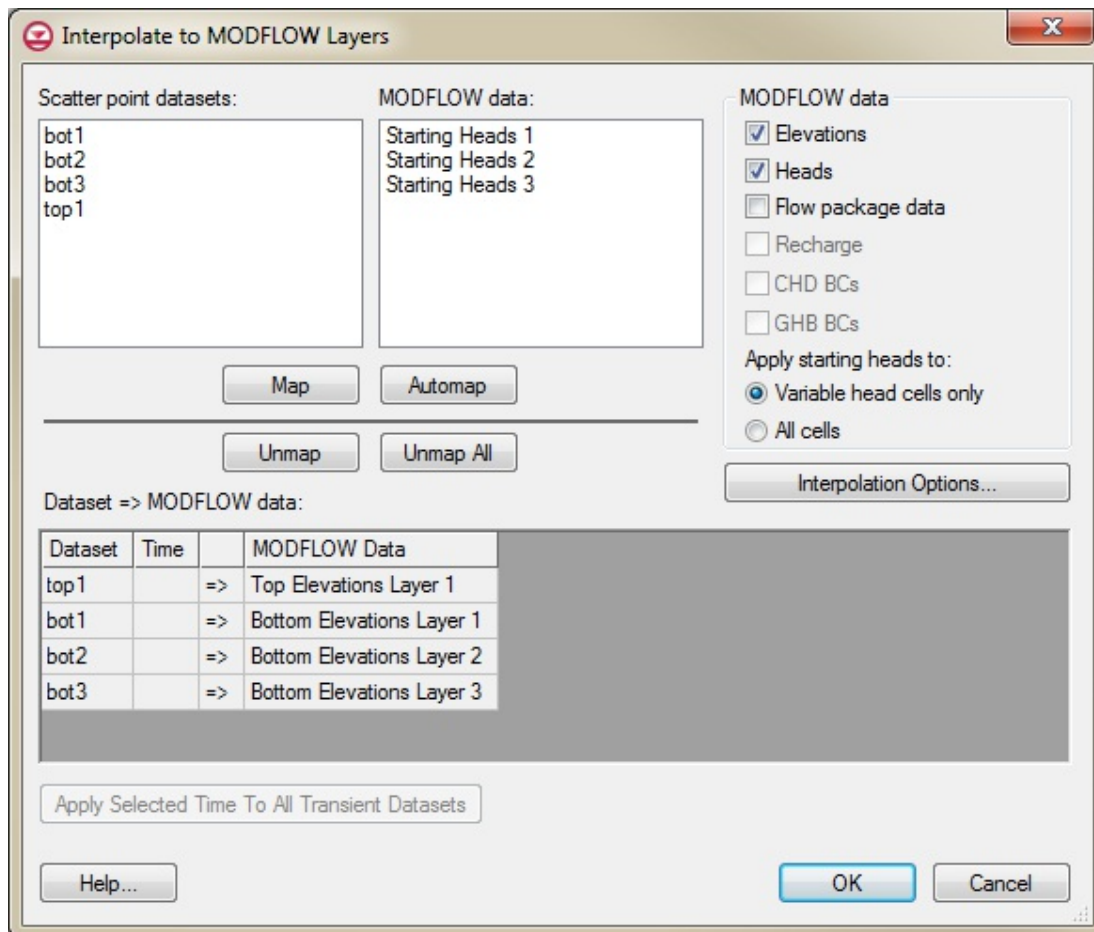

The Interpolate to MODFLOW Layers dialog

In this dialog, select various 2D scatter point datasets and associate them with MODFLOW input data. GMS will then interpolate from the 2D scatter point data to the MODFLOW input data.

This is often useful to define the layer elevations of a MODFLOW model. See [Defining Layer Elevations](#) for more information on MODFLOW layer elevations.

Associate 2D scatter point data with MODFLOW data by selecting a dataset in the list on the left of the dialog and selecting an item from the MODFLOW data list on the right and then selecting the **Map** button. The association between the datasets and the MODFLOW data is shown in the spread sheet labeled *Dataset → MODFLOW data*.

The *MODFLOW data* group box contains options to allow picking which MODFLOW data they would like to interpolate to.

- *Elevations* refers to the top and bottom elevations of the 3D grid.
- *Heads* refers to the starting heads.
- *Flow package data* refers to the various input arrays for the LPF or BCF packages (HK, VK...).
- *Recharge* refers to the recharge rate specified in the RCH package.
- *CHD BCs* refers to the starting and ending heads associated with existing CHD boundary conditions in the MODFLOW model.
- *GHB BCs* refers to the starting and ending heads associated with existing GHB boundary conditions in the MODFLOW model.

The **Automap** button will try to automatically map the datasets to the MODFLOW data by matching names and layer numbers. The Unmap button is used unmap the selected item(s) in the spread sheet. The **Unmap All** button is self explanatory.

The **Interpolation Options** button will bring up the [2D Interpolation Options dialog](#).

Transient Interpolation

If a 2D scatter point dataset is transient and the user is interpolating to MODFLOW data that does not vary with time then the user will select a time step from that dataset to interpolate to the MODFLOW data. When the user has selected a time step the **Apply Selected Time To All Transient Datasets** button will undim. This button allows the user to set the selected time of all of the transient datasets to be the same as the currently selected time.

If the current MODFLOW model is transient and the user is interpolating to *Recharge* then interpolation will occur for each stress period defined in the MODFLOW model. For a particular stress period, the closest data set time step whose time is less than the beginning of the stress period is used. Figure 1 illustrates this process.

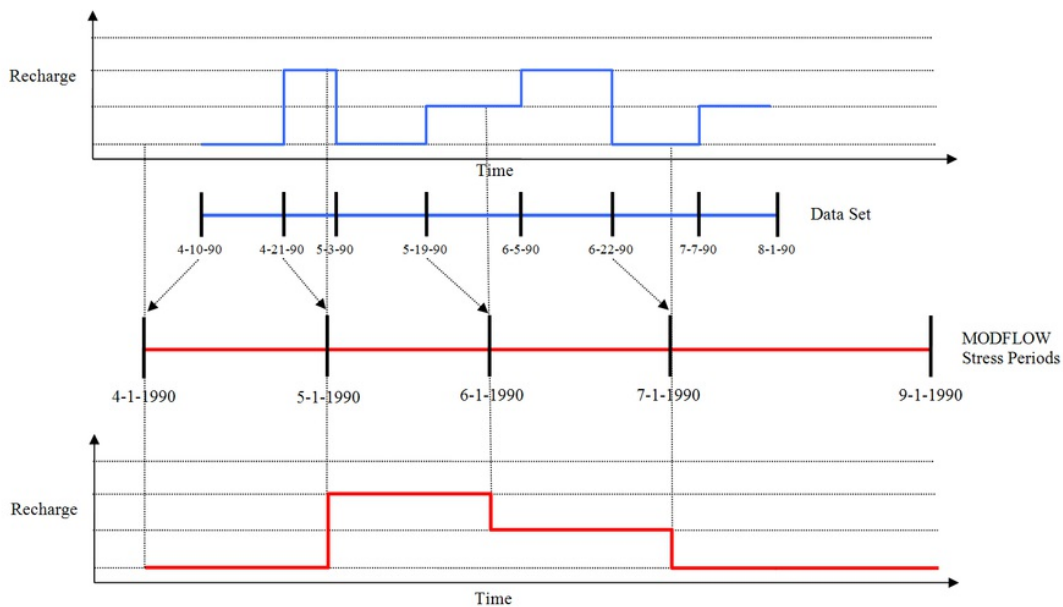

Figure 1: Transient interpolation of Recharge

If the current MODFLOW model is transient and the user is interpolating to *CHD BCs* then interpolation will occur at the beginning and the end of each stress period (because a start head and an end head are specified for each CHD BC). If there is no dataset time step that matches the beginning or the end of the stress period then GMS will linearly interpolate between dataset time steps. Figure 2 illustrates this process.

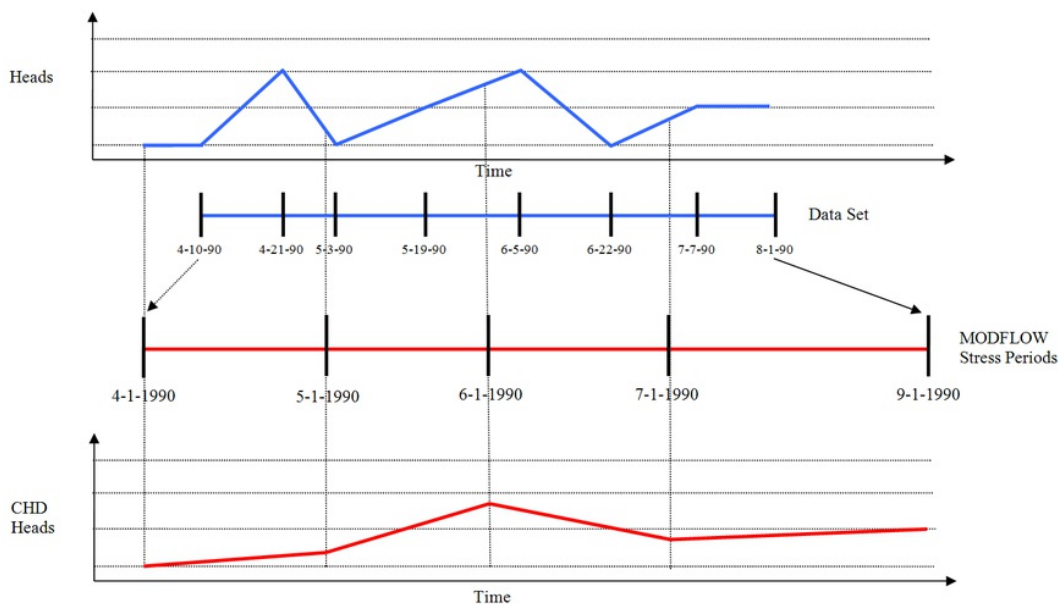

Figure 2: Transient interpolation of CHD BCs

If the current MODFLOW model is transient and the user is interpolating to *GHB BCs* then interpolation will occur at the beginning of each stress period. If there is no dataset time step that matches the beginning or the end of the stress period then GMS will linearly interpolate between dataset time steps. Figure 3 illustrates this process.

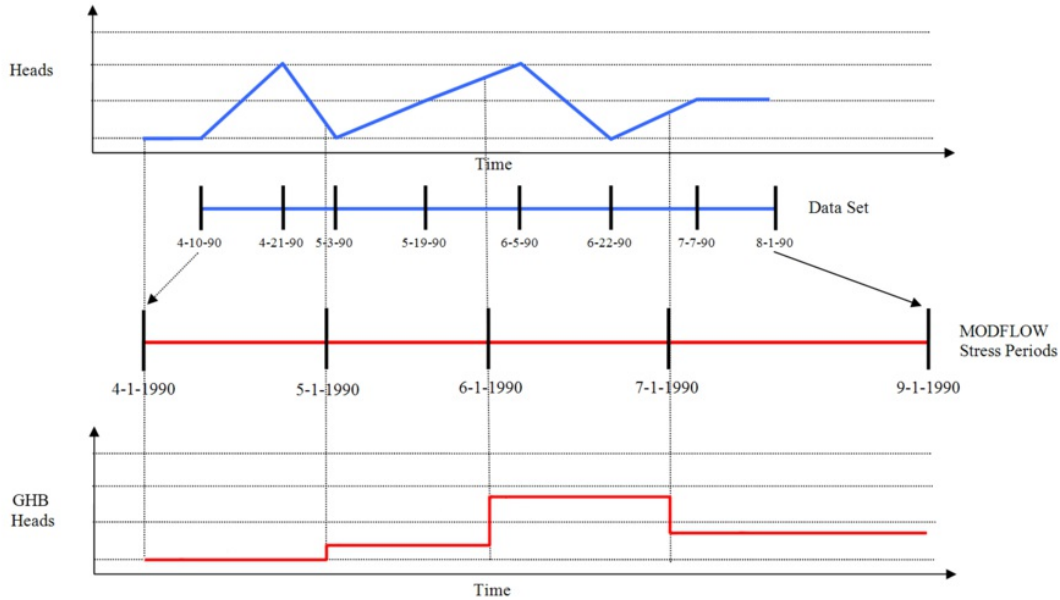
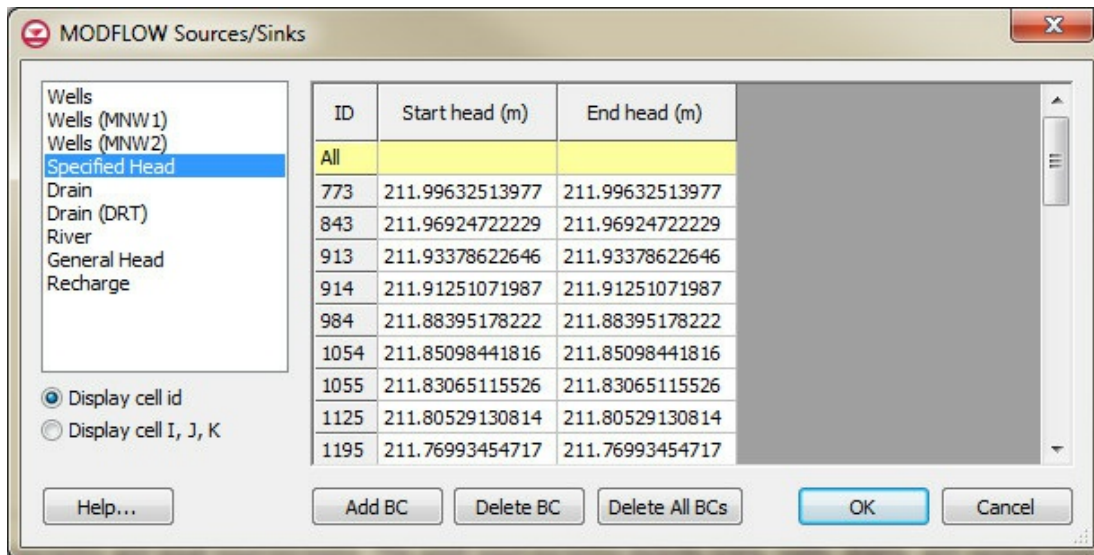

Figure 3: Transient interpolation of GHB BCs

MODFLOW Source/Sink Dialog

The *Sources/Sinks* dialog allows editing of both point sources/sinks and areal sources/sinks.



The MODFLOW Source/Sink dialog

Point Sources/Sinks

The MODFLOW stresses can be categorized as point sources/sinks and areal sources/sinks. The point sources/sinks include rivers, wells, drains, and general head. Point sources/sinks are not assigned using arrays. Rather, they are associated with individual cells. Two methods are used to define point source/sink data. The simplest method is to define them as part of a MODFLOW conceptual model defined in the Map module. Another method is to assign them by selecting a set of cells and using the **Sources/Sinks** command.

The **Sources/Sinks** command is used to both assign and edit river, drain, general head, and well type sources/sinks. Before selecting the **Cell Sources/Sinks** command, a set of cells should be selected using the cell selection tools. Once the command is selected, the *Point Sources/Sinks* dialog appears.

Creating New Sources/Sinks

A new instance of a source/sink of a particular type is created by selecting the **Add** button for the type. This creates a new source/sink and displays a default value or set of values for the source/sink in the edit fields on the right side of the dialog. If the simulation is steady state, normal edit fields are used to enter the values. If the simulation is transient, buttons appear which can be used to bring up the *XY Series Editor*. A value is entered for each of the defined stress periods.

Multiple instances of a source/sink can be created by repeatedly selecting the **Add** button. Each cell can contain multiple sources/sinks of a particular type or a mixture of several types.

Editing Sources/Sinks

An existing source/sink can be edited by selecting the name of the source/sink in the *source/sink* list. The values associated with the highlighted source/sink are displayed in the spread sheet.

Deleting Sources/Sinks

An instance of a source/sink may be deleted by selecting the source sink from the list and selecting the **Delete** button.

Constant Values

Several of the parameters shown in the *Point Sources/Sinks* dialog, such as elevation and conductance, are not likely to change during a transient simulation. A constant value can be entered for these parameters in the *XY Series Editor* and the resulting curve is a flat line.

Areal Sources/Sinks

The **Areal Sources/Sinks** command is used to edit recharge and evapotranspiration parameters on a cell-by-cell basis. Before selecting the **Areal Sources/Sinks** command, a set of cells should be selected using the cell selection tools. Recharge and evapotranspiration parameters are applied to vertical columns rather than to individual cells.

Therefore, to edit the value for a vertical column, any cell in the column can be selected. Once the **Areal Sources/Sinks** command is selected, the *Areal Sources/Sinks* dialog appears. The options in the dialog are as follows:

Packages

If the Recharge package has not been activated (using the *Packages* dialog which is accessed through the *Global Options\Basic Package* dialog) the *Recharge* portion of the *Areal Sources/Sinks* dialog is dimmed. Likewise, if the Evapotranspiration package has not been activated, the *Evapotranspiration* portion of the dialog is dimmed.

Editing Values

The edit fields to the right of each option are used to enter the values of the parameters associated with each type. The fields are standard edit fields if the simulation is steady state and are graphic windows displaying a time series if the simulation is transient. Clicking on the window brings up the *XY Series Editor* dialog. The [XY Series Editor](#) is a general purpose editor for entering curves or lists of pairs of data (e.g., rainfall rate vs. time). Once a curve is defined in the editor, it is displayed graphically in the window.

Layers

The *Layer* option in the *Recharge* portion of the dialog is only active (undimmed) if the *Recharge at Specified Vertical Cells* option is chosen in the *Recharge Package* dialog. Likewise, the *Layer* option in the *Evapotranspiration* portion of the dialog is only active if the *ET at Specified Vertical Cells* option is chosen in the *Evapotranspiration Package* dialog.

Editing Multiple Cells

After a set of source/sink parameters has been defined, it is often necessary to change one of the parameters of a subset of the cells (vertical columns).

For example, suppose the Evapotranspiration package has been activated and each vertical column was assigned a unique value of elevation, extinction depth, and maximum evapotranspiration rate. Suppose that it becomes necessary to change the extinction depth of a large subset of the vertical columns to a constant value while leaving the other

parameters unchanged. The *Areal Sources/Sinks* dialog has been designed so that it can be used to change one of the parameters without altering the other parameters.

If more than one cell is selected when the *Areal Sources/Sinks* dialog is brought up, the available edit fields appear with a checkerboard pattern if the values in the cells are not all identical. Before editing a parameter, click on the field to switch it from multi-select mode to normal mode. When the **OK** button is selected after the parameters have been edited, only the parameters that have been selected are changed. For example, in the case of changing the extinction depth, if the extinction depth is edited, the extinction depth of all of the vertical columns associated with the selected cells is changed to the new value but the individual values of elevation and maximum evapotranspiration rate are left unchanged.

See also

- [MODFLOW Packages Supported in GMS](#)

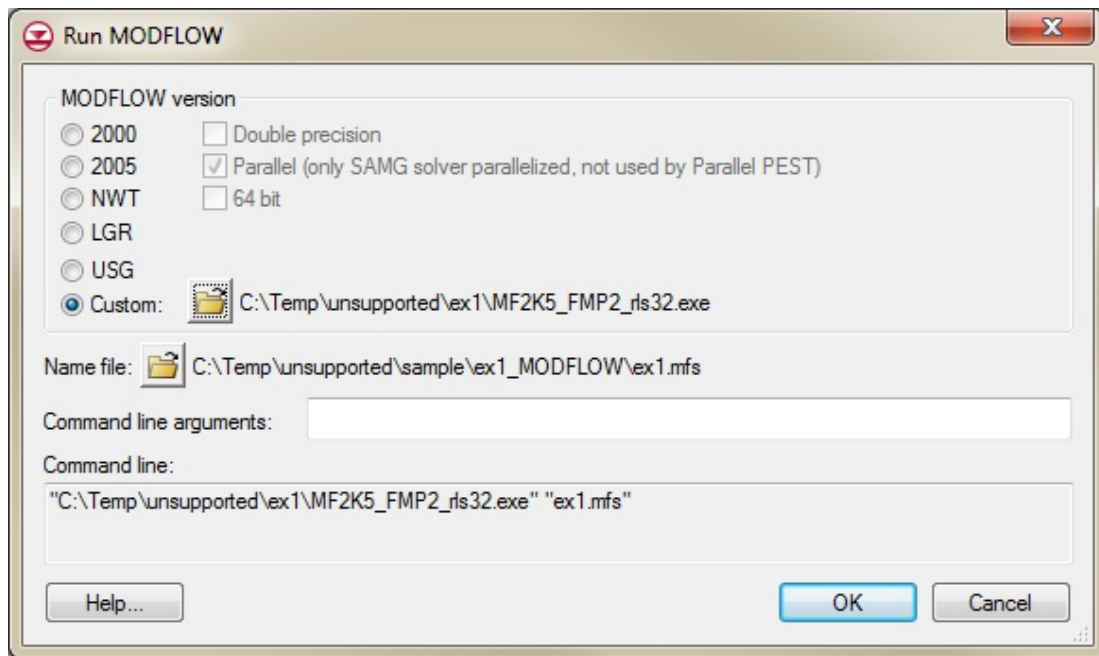

Custom Run MODFLOW

The *Run MODFLOW* dialog appears after selecting the *MODFLOW | Run MODFLOW* menu command if the *Use custom Run dialog* option is turned on in the *MODFLOW Global/Basic Package* dialog.



Example of the Run MODFLOW dialog.

To use this dialog:

1. In the *Name file* area, browse  to and select any MODFLOW name file to use as input.
2. Next, in the *MODFLOW version* section, pick the version of MODFLOW to run; or select a custom version of MODFLOW to run by browsing  to a custom MODFLOW executable.
3. Finally, specify any additional *Command line arguments* in the field provided.

The text box at the bottom of the dialog will show the full *Command line* that will be executed upon selecting the **OK** button.

The options selected in this dialog will override any run selections made in the *MODFLOW Global/Basic Package* dialog. Defaults that have been set in the *MODFLOW Global/Basic Package* dialog will automatically be selected for the custom run and must be turned off if not desired.

Available MODFLOW versions include:

- 2000
- 2005
- NWT
- LGR
- USG
- Custom – Does not allow selecting binary type.

The type of binary executable can also be specified. Options include: double precision, parallel, or 64 bit.

Note: only SAMG solver will parallelize. The parallel PEST solver will not use this parallel process.

CLN Process

The Connected Linear Network (CLN) process was developed for MODFLOW-USG to model one dimensional connected features that are much smaller than a groundwater flow model's cells. The CLN Process can be used to replace multi-cell wells that would use the MNW1 or MNW2 package in other versions of MODFLOW.

Conceptual Model

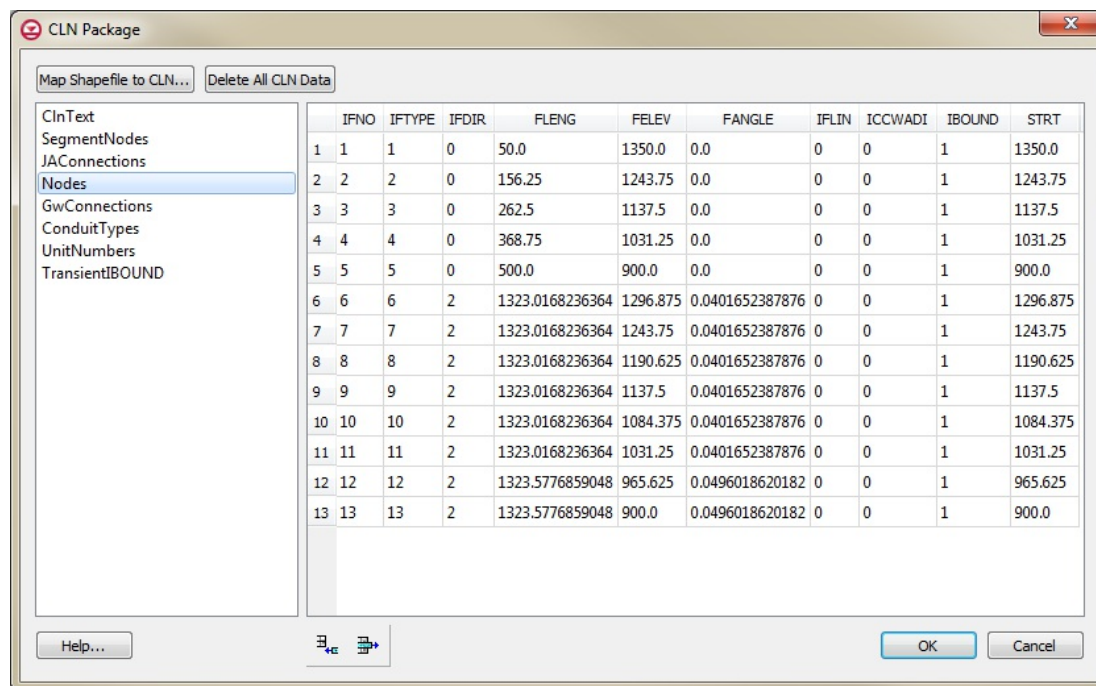

MODFLOW CLN Process dialog showing the Nodes options

A CLN well can be added to a [conceptual model](#) by creating a point using the "Wells (CLN)" type. The geometry of the well screen can be set using the **Use screen** attribute for a single vertical screen. Otherwise, the generated well nodes include the grid layers specified for the coverage by its default layer range. For transient models, the CLN well node IBOUND values are disabled until the first stress period with a non-zero flow rate.

CLN Process Dialog

The CLN process values can be edited in the *CLN Process* dialog reached through the *MODFLOW | Optional Packages | CLN – Connected Linear Network* menu command.

The dialog contains tables that can be accessed by selecting a table from the list at the left of the dialog.

- ClnText
- SegmentNodes – The CLN process contains nodes that can be connected together. Each connected nodes have a unique *ClnSegmentId*, and each node has a unique *IFNO* value.
- JAConnections – Allows editing the connectivity of nodes similar to the SegmentNodes table.
- Nodes – This table allows data for CLN nodes to be edited and viewed including the starting head and IBOUND values for each node.
- GwConnections – This table shows the connections between the CLN process and nodes and the groundwater process cells. The IGWNOD column contains the cell ID of the connected groundwater node.
- ConduitTypes – This table shows the conduit types generated for each CLN node and the associated mapped values for FRAD and CONDUITK previously entered in the Map module.
- UnitNumbers
- TransientIBOUND – Edits changing IBOUND values in transient models. This table can be edited when cells become active and inactive.

A detailed description of CLN process input is available with the MODFLOW-USG documentation available at the USGS [MODFLOW-USG website](#).

Map Shapefile to CLN

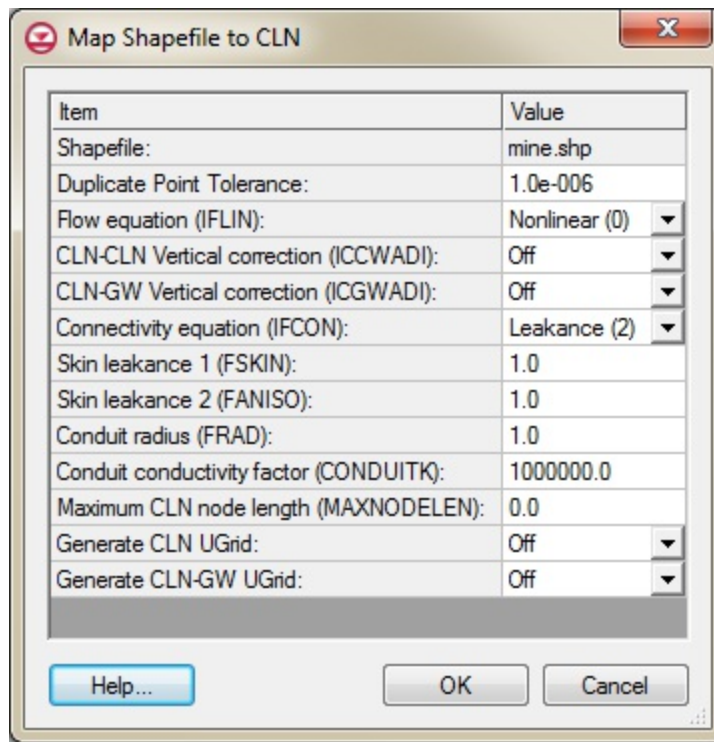

The Map Shapefile to CLN dialog

The Connected Linear Network (CLN) process was developed for MODFLOW-USG to have the ability to model complex one-dimensional connected features that are much smaller than a groundwater flow model's cells. A three-dimensional arc shapefile can be used to store the geometry and attributes of such a linear network. Attributes can optionally be applied to the arcs of the shapefile.

Optional Shapefile Arc Attributes

Name	Description	Default Values
IFLIN	Flow equation	Nonlinear (0)
ICCWADI	CLN to CLN Vertical correction	Off (0)
ICGWADI	CLN to CLN Vertical correction	Off (0)
IFCON	Connectivity equation	Leakance (2)
FSKIN	Skin leakance 1	1.0
FANISO	Skin leakance 2	1.0
FRAD	Conduit radius	1.0
CONDUITK	Conduit conductivity factor	1000000.0
IBOUND		1
MAXNODELEN	Maximum CLN node length	0.0

Clicking the **Map Shapefile to CLN** button in the *CLN Process* dialog will first bring up a *Select Arc Shapefile* dialog. Once a shapefile has been selected, the *Map Shapefile to CLN* dialog will appear. The settings items in this dialog are used when attributes are not specified as arc attributes by the shapefile. The settings dialog includes some additional

items. Arc points within the *Duplicate Point Tolerance* are snapped together and their CLN nodes are connected. By default, mapping a shapefile to CLN deletes the existing CLN data. When *Append to existing CLN data* is turned on the generated CLN data is appended to the existing data which can be useful when using CLN wells. With the final two settings, *Generate CLN UGrid* and *Generate CLN-GW UGrid*, UGrids are generated which can be visualized in GMS for the generated CLN network and also the part of the CLN network that is connected to the groundwater model.

CLN Wells Dialog

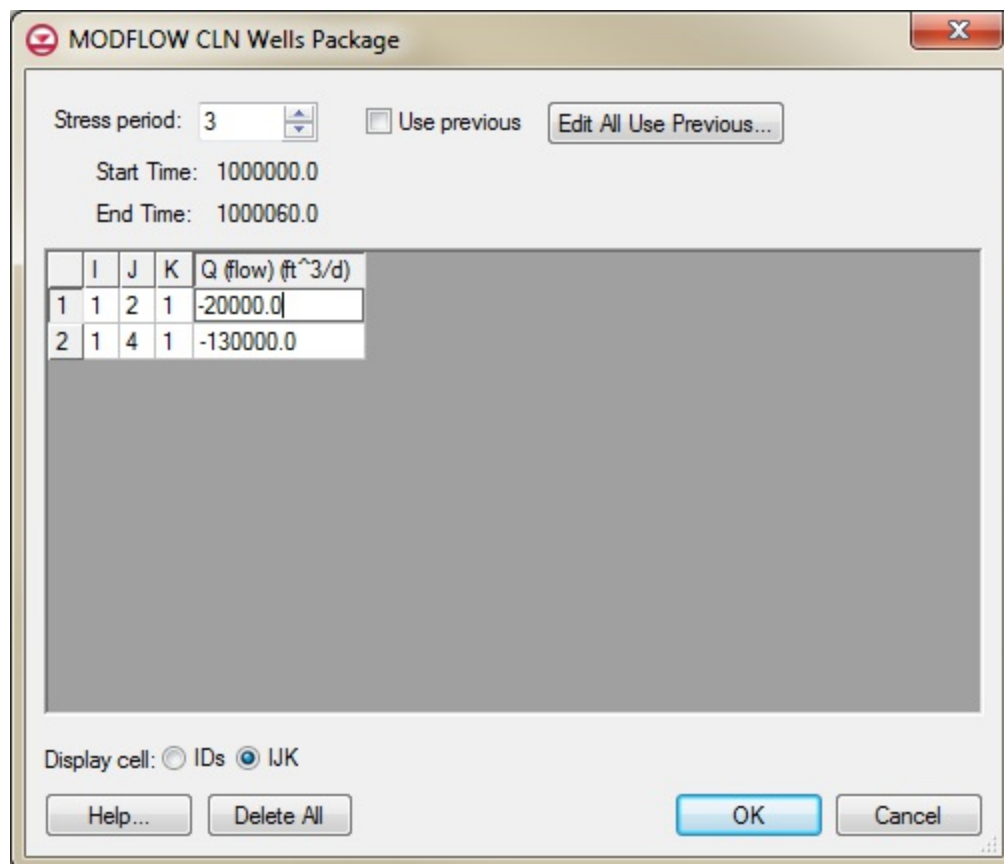

The *MODFLOW CLN Wells Package* is similar to the [WEL Package](#) dialog. It is reached through the *MODFLOW | Optional Packages | CLN Wel – CLN Well* menu command. It allows CLN well flow rates to be viewed and edited, and CLN wells can also be deleted. The *Cell ID* table column is the CLN Process node ID of the well.



The MODFLOW CLN Wells Package dialog

6.4.3. MODFLOW Post-Processing

MODFLOW Display Options

The properties of all MODFLOW data that GMS displays on the screen can be controlled through the MODFLOW tab of the *Display Options* dialog. This dialog is opened by right-clicking on the  MODFLOW entry in the [Project Explorer](#) and selecting the **Display Options** command. It can also be accessed from the *Display* menu, the *MODFLOW* menu, or the  **Display Options** macro. The following table describes the display options available for the 3D Grid module.

Display Option	Description
Wells, Drains, Rivers, Streams, General head, Constant head, Transient head	These items on the left side of the dialog represent source/sink objects. If the check box just to the left of each source/sink name is selected, a symbol is displayed at the center of each cell with that type of source/sink. The symbol for each source/sink is displayed to the left of the check box. The symbol can be changed by selecting the symbol button. This brings up the symbol editor dialog. The symbol editor contains a list of available symbols. The dialog can also be used to edit the size and color of the symbol.
Horiz. flow barriers	The <i>Horiz. flow barrier</i> option displays a line at the location of each horizontal barrier. The attributes (thickness, color, etc.) can be edited by clicking on the small window to the left of the <i>Horiz. flow barrier</i> toggle.
Dry cells	If the <i>Dry cells</i> option is selected, the chosen symbol will be displayed at the location of all dry cells in the grid. A MODFLOW solution must be imported to GMS prior to displaying dry cells. When a cell goes dry during a MODFLOW simulation, the HDRY value defined in the <i>BCF Package</i> is assigned as the head value for the cell. If an HDRY value is encountered in the active scalar dataset when the display is refreshed, the cell is assumed to be dry.
Water table	If the <i>Water table</i> option is selected, the water table defined by a MODFLOW solution is superimposed on the layer geometry when a grid cross section is displayed in orthogonal mode. The water table is defined as the head value in the uppermost active cell. If the water table display is on, all contours (head, concentration, etc.) are clipped so that they lie at or below the water table. This option is only available if the True Layer mode is active.
Mark flooded cells	The <i>Mark flooded cells</i> option is used in conjunction with the True Layer approach to defining layer data. With the True Layer approach, the top elevation is entered for each layer, regardless of the layer type. With many models, the top layer is an unconfined layer and the top elevation represents the ground surface. For unconfined layers, the top elevation array is not read by MODFLOW. Only the bottom elevation array is used in the calculations. MODFLOW assumes that the top layer extends to an infinite height. It is often the case that the computed water table elevation exceeds the elevation of the ground surface. The <i>Mark flooded cells</i> option is used to draw a symbol at the center of all cells where the computed water table elevation is greater than the top elevation of the top layer in the grid.
Lake cells	If the <i>Lake cells</i> option is selected, a symbol is draw in the center of each cell representing a lake. The symbol, the symbol size, and symbol color can be adjusted by clicking on the button to the left of the Lake cells toggle.
Lake ID's	If the <i>Lake ID's</i> option is selected, each cell representing a lake will display the lake ID in the center of the cell. The font, font size, and font color can be adjusted by clicking on the button to the left of the Lake ID's toggle.
Display symbol legend	If the <i>Symbol legend</i> option is selected, a legend showing each of the symbols associated with sources/sinks, dry cells, and flooded cells is displayed in the lower right corner of the GMS window.
Display hydrogeologic units	The <i>Display hydrogeologic units</i> option is used to display HUF data. This option only works if the current display mode is Ortho Mode. This mode can be turned on in the <i>Display</i> menu.
Check All	By clicking this button, all of the display options are turned on.
Check None	By clicking this button, all of the display options are turned off.

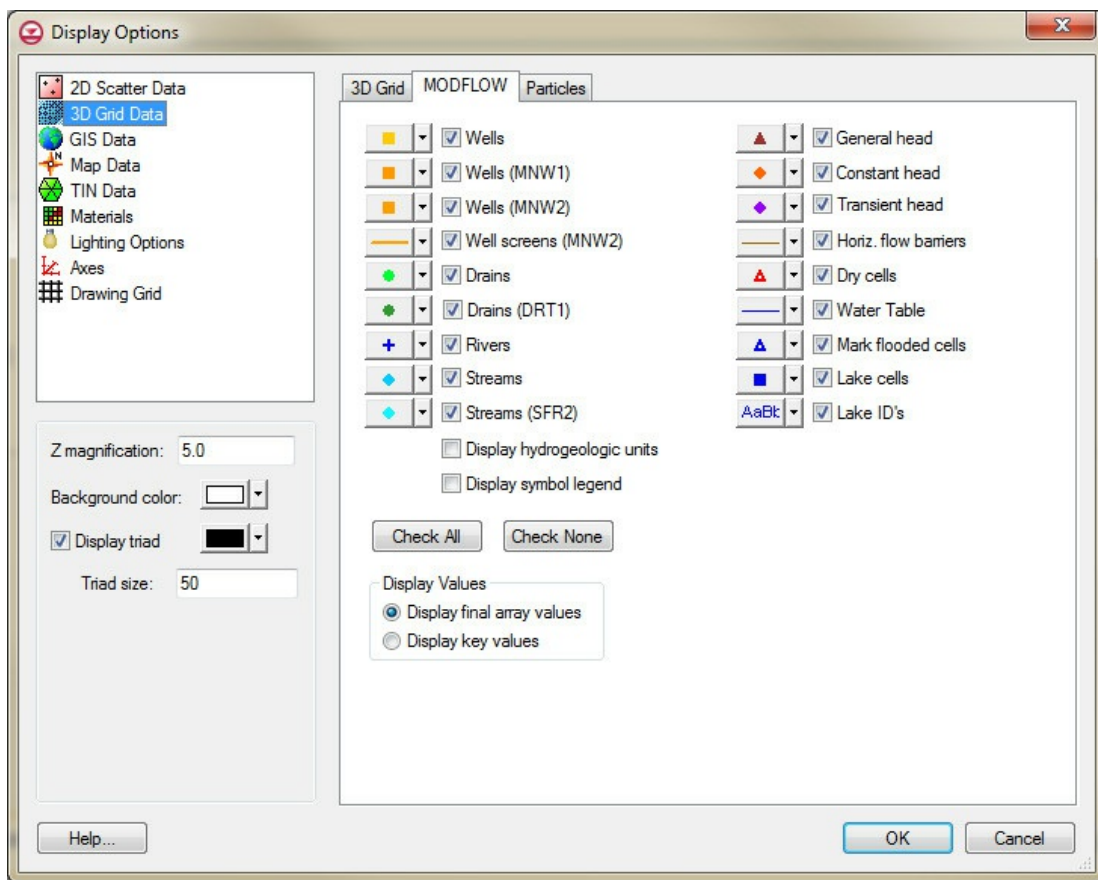

The Display Options dialog showing the MODFLOW tab of the 3D Grid Data item.

MODFLOW Post-Processing Viewing Options

In addition to generating and editing the MODFLOW input files, GMS can also be used for post-processing the solution files computed by MODFLOW. The solution files computed by MODFLOW include head, drawdown, and CCF (Cell-to-Cell Flow) files. By default, the head and CCF files are automatically generated. The output options are controlled in the MODFLOW [Output Control dialog](#).

No-Flow and Dry Cells

When a MODFLOW simulation is solved, MODFLOW writes out a head or drawdown value for every cell of the finite difference grid to the solution files. However, some of the cells are either outside the problem domain or they have gone dry during the course of the simulation. These cells are flagged by MODFLOW in the output file by writing special values for the cells. The value assigned to inactive cells is the No flow head value specified in the [Global Options/Basic Package dialog](#). The value assigned to cells which have gone dry is the Head assigned to dry cells value defined in the [BCF](#), [LPF](#) or [HUF](#) package dialogs. If the MODFLOW data are in memory when the solution is read in, GMS will automatically use the No flow head and Head assigned to dry cells values to define active/inactive cells for post-processing.

Cell Summary Text File

When a MODFLOW solution is imported into GMS there is an [option](#) to generate a "cell summary" text file. This file lists the time, stress period, time step and the number of active, inactive, dry and flooded cells. If the file exists then it will be added to the MODFLOW solution in the Project Explorer and the file can be opened in a text editor from GMS. The file is in *.csv format so that spreadsheet programs can easily read and format the file into columns. Two examples are shown below.

Example 1

```
Time, SP, TS, Active, Inactive, Dry, Flooded
0.0, 1, 1, 10642, 4463, 1, 0
0.0264713484794, 2, 1, 10642, 4463, 1, 0
0.0661783739924, 2, 2, 10642, 4463, 1, 0
0.1257389187813, 2, 3, 10642, 4463, 1, 0
```

Example 2

```
Date/Time, Time, SP, TS, Active, Inactive, Dry, Flooded
11/16/1985 12:00:00 AM, 46.0, 1, 1, 4831, 1329, 0, 1431
1/1/1986 12:00:00 AM, 92.0, 1, 2, 4831, 1329, 0, 1431
3/1/1986 12:00:00 AM, 151.0, 2, 1, 4831, 1329, 0, 0
3/8/1986 3:00:00 PM, 158.625, 3, 1, 4831, 1329, 0, 0
```

The active cells include all cells with an IBOUND value not equal to 0 and cells that have had the IBOUND change to nonzero during the model run (this can occur if the rewetting option is used in the flow package). The inactive cells include cells with IBOUND=0 as well as cells that are set to IBOUND=0 while the simulation was running (Some versions of MODFLOW will do this to dry cells; MODFLOW-NWT does not inactivate dry cells). The dry cells include cells that have the value of HDRY assigned to them or cells where the head is below the bottom elevation of the cell (Note with MODFLOW-NWT a dry cell can still be active.). The flooded cells include cells where (1) the head is above the top elevation of the cell, (2) the cell is not in a layer with a confined layer type defined in the flow package, and (3) the cell is the highest active cell in the vertical column of cells.

Layer Contours

In most cases, the best way to display computed head and drawdown is with layer contours. Layer contours are generated by selecting the *Contours* option in the *3D Grid* tab of the *Display Options* dialog. This option is automatically turned on whenever a MODFLOW solution is read into GMS. The **Mini-Grid Toolbar**, which is part of the [Tool Palettes](#), can be used to switch between layers.

Viewing Computed Fluxes

The CCF file that is part of the MODFLOW solution contains useful information about the computed flux rates between the aquifer and external sources and sinks. A special set of tools are provided for viewing computed fluxes.

Summation of Fluxes on Arcs and Polygons

GMS writes the necessary files so that MODFLOW will output the computed flow for boundary conditions created in the Map module. These computed flows can be viewed by selecting the appropriate feature object (river arc, etc) and then looking at the [Status Bar](#). For an object with an assigned observed flow, the observed flow value and the residual error are displayed in addition to the computed flow. For objects without an observed flow, only the computed flow is shown.

This cannot be done for SFR stream arcs since the SFR package does not participate in the Observation Process.

Calibration Targets and Statistics

For objects with an observed flow, a [calibration target](#) can be plotted on the object. The calibration target provides a graphical representation of the calibration error. Calibration targets are described in section 14.5. The display of flow calibration targets is turned on by selecting the **Display Options** command in the *Feature Objects* menu when the local source/sink coverage is the active coverage.

Flow Budget for Selected Cells

If a MODFLOW model is built without using the conceptual model approach (directly from the grid), the computed fluxes corresponding to a user-defined set of cells can still be displayed. This is accomplished by selecting a set of cells and selecting the **Flow Budget** command from the *Data* menu in the 3D Grid module. This command brings up the *Flow Budget* dialog. This dialog lists the complete flow budget for the selected cells.

GMS also includes a [Zone Budget tool](#) to view the computed flows into (out of) user defined zones.

Vector Plots

If a CCF file has been imported as described above, a vector plot can be generated to illustrate the flow field computed by MODFLOW. The CCF file contains flows through each of the cell walls in the grid, i.e., the flow from each cell to each of its six surrounding cells.

Vectors are generated by right-clicking on the CCF file  in the Project Explorer and selecting the **CCF→Velocity Vectors** command. The cell top and bottom elevations as well as the porosity are used when calculating the velocity vectors. Therefore, for GMS to compute the vectors, a MODFLOW simulation must exist in GMS. Although porosity is not an input to a MODFLOW model, the porosity can be specified per cell, using the cell properties dialog, whenever a MODFLOW simulation exists.

The vectors are computed by reading the CCF file to get the net flow through each grid cell face. Each component of the velocity vector is computed by dividing the flow through the cell face by the saturated area of the face multiplied by the porosity. For example, the *I*, *J*, *K* direction components of the vector are calculated as follows:

- $$vector_i = \frac{flow_i}{(saturated_{Area_i})(porosity)}$$
- $$vector_j = \frac{flow_j}{(saturated_{Area_j})(porosity)}$$
- $$vector_k = \frac{flow_k}{(area_k)(porosity)}$$

The saturated area may be less than the area of the cell face if the computed head is below the top elevation of the grid cell. The velocity vector is set to 0.0 in cells that are inactive, dry (the computed head is below the cell bottom elevation), or have inappropriate elevations (the top elevation is below the bottom elevation).

Prior to version 8.2.

To generate a vector dataset from the CCF file, right-click on the CCF dataset  in the Project Explorer and select the **Generate vectors** command from the pop up menu. A flow vector is generated at each cell center by computing a vector sum of the flows through the

six walls of the cell. The resulting vectors can be plotted by selecting the [Vectors](#) option in the [3D Grid Display Options](#) dialog.

Viewing the Printed Output File

Two types of output are produced by MODFLOW: a printed output file and a set of solution files (head, drawdown, CCF). Before reading in the solution files, it is often useful to examine the printed output file. In some cases, MODFLOW may crash or not complete its run successfully. Determine if the run was completed successfully by viewing the printed output file. When viewing the file, check to make sure that a solution was output for all stress periods and time steps that were expected. In some cases MODFLOW will also output to the listing file a description of any problems which may have occurred.

GMS provides two ways to view the text files produced by MODFLOW and the other analysis codes:

1. When a solution is read into GMS, the text output files are placed into the data tree. Double-clicking on their file icons  in the [Project Explorer](#) will bring up the text files in a text editor.
2. Any text file can be viewed by selecting the **Edit File** command in the *File* menu. A File Browser appears and the selected file is opened in a text editor.

MODFLOW Solution Properties Dialog

The MODFLOW *Properties* dialog box is opened by right-clicking on the MODFLOW solution folder in the Project Explorer.

The data in this dialog come from the "*.os", "*.ww", "*.r", and "*.w" files computed by the MODFLOW observation process. The computation from MODFLOW will include any observed flows combined with the observed heads to calculate a single error value. In a transient model, the error value includes all of the observations at the various times. The error shown in this dialog is different from the error found in the [Error Summary plot](#).

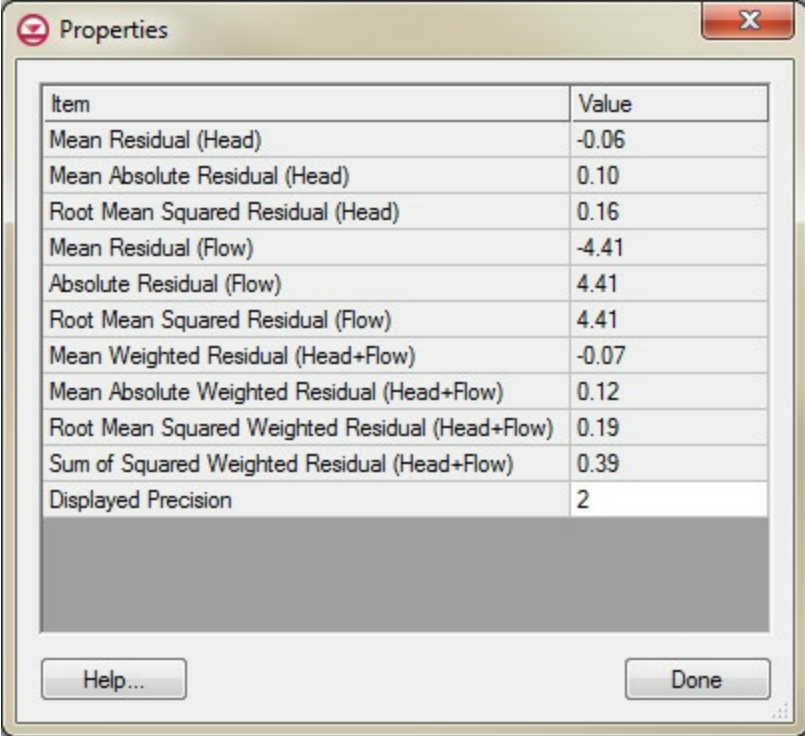

The screenshot shows a dialog box titled "Properties" with a table of error metrics. The table has two columns: "Item" and "Value". The items and their corresponding values are as follows:

Item	Value
Mean Residual (Head)	-0.06
Mean Absolute Residual (Head)	0.10
Root Mean Squared Residual (Head)	0.16
Mean Residual (Flow)	-4.41
Absolute Residual (Flow)	4.41
Root Mean Squared Residual (Flow)	4.41
Mean Weighted Residual (Head+Flow)	-0.07
Mean Absolute Weighted Residual (Head+Flow)	0.12
Root Mean Squared Weighted Residual (Head+Flow)	0.19
Sum of Squared Weighted Residual (Head+Flow)	0.39
Displayed Precision	2

At the bottom of the dialog box, there are two buttons: "Help..." and "Done".

MODFLOW Properties dialog box

Comment on different error values

- *Mean Residual* – Average error for the observations. This can be misleading because the positive and negative errors can cancel.
- *Mean Absolute Residual* – Mean of the absolute error values for the observations. This

is a true mean, not allowing positive and negative errors to cancel.

- *Root Mean Squared Residual* – RMS is calculated by taking the average of the square of the errors for the observations and then taking its square root. This tends to give more weight to cases where a few extreme error values exist.
- *Sum of Squared Weighted Residual* – This is the error value that is minimized by a PEST run.

Point head observation errors

- *Mean Residual (Head)*.
- *Mean Absolute Residual (Head)*.
- *Root Mean Squared Residual (Head)*.

Flow observation errors

- *Mean Residual (Flow)*.
- *Mean Absolute Residual (Flow)*.
- *Root Mean Squared Residual (Flow)*.

Combined head and flow error values

- *Mean Weighted Residual (Head+Flow)*.
- *Mean Absolute Weighted Residual (Head+Flow)*.
- *Root Mean Squared Weighted Residual (Head+Flow)*.
- *Sum of Squared Weighted Residual (Head+Flow)*.

GSF File Format

A Grid Specification File (*.gsf) is used with MODFLOW-USG to define the unstructured grid geometry. The grid specification file for a structured grid is far less complex than for an unstructured grid. The lack of structure precludes omission of the coordinates of the vertices of each model cell. Hence the locations of these vertices must be specified in the grid specification file, together with the node that is associated with a model cell.

The format is defined [in the Groundwater Data Utilities article](#)) and repeated in the image below:

Line 1:

"UNSTRUCTURED GWF"

Note: If "GWF" is omitted, then it is assumed.

Line 2:

nnode nlay iz ic

where:

nnode is the number of nodes in the grid

nlay is the number of layers in the model

iz is 1 if elevations of node and mesh element vertices are supplied; 0 otherwise

ic is 1 if the cell specifications associated with each node are supplied; 0 otherwise

Note. All utilities documented herein, as well as PLPROC, require that both *iz* and *ic* be 1. Options associated with values other than 1 are not presented below. If these are omitted from the grid specification file they are assumed to be 1.

A list of vertex coordinates is now provided. These vertices will be cited by index later in this file where mesh geometric details are provided. The indices of vertices are defined implicitly by their positions in the following list. Numbering is assumed to begin at 1.

Line 3:

nvertex is the number of element vertex definitions to follow

NVERTEX next lines:

x, y, z

where:

x, y and z are the coordinates of each vertex

NNODE next lines:

inode x y z lay m (ivertex(i),i=1,m)

where:

inode is a node number (these must be supplied in increasing order starting from 1)

x, y and z are node coordinates

lay is the layer number of the node

m is the number of vertices defining the three-dimensional element associated with the node

ivertex are node indices defined with reference to the node list provided above

Figure 2.21 Specifications of a MODFLOW-USG grid specification file.

MODFLOW World File

A MODFLOW world file is a plain text file containing the geographic location of a MODFLOW model. The world file contains three lines including the origin, rotation about the z axis, and the path of a projection file. The world file is found in the same directory as the name file. The MODFLOW world and projection files are automatically written by GMS when the project has a global projection.

Format

```
ORIG x y z  
ROTZ theta  
PRJ_FILE "file_path"
```

The ORIG line contains the space separated x, y, and z coordinates of the outside corner of the model cell at the first column and last row.

The ROTZ line contains the counter-clockwise (looking down) rotation of the model about the origin coordinate in degrees.

The PRJ_FILE line contains the absolute or relative path to the model's projection file which ends in with a *.prj extension. The file path is surrounded by double quotes.

Sample

```
ORIG 612086.0 3429376.55 230.0  
ROTZ 90.0  
PRJ_FILE "modfmap.prj"
```

Error Summary Plot

An *Error Summary* plot is one of the plot types that can be created by the [Plot Wizard](#). See the [Error Summary](#) plot section on the Plot Wizard page for a basic description. The *Error Summary* plot is used to display a text listing of the mean error, mean absolute error, and root mean squared error for an observation measurement in a coverage. The error values may be listed for a single time step of a dataset or for all time steps.

Error types

Three error types are shown in the plot:

1. *Mean Error*: This is the average error for the points. This value can be misleading since positive and negative errors can cancel.
2. *Mean Absolute Average*: This is the mean of the absolute values of the errors. It is a true mean, not allowing positive and negative errors to cancel.
3. *Root Mean Square*: This takes the average of the square of the errors and then takes its square root. This norm tends to give more weight to cases where a few extreme error values exist.

Time matching

When the measurement is transient (i.e., observed heads at various times) then it is very unlikely that the output times from the model match the times when the field measurements were taken. In this case GMS will interpolate an observed value at the model output time. If the model output time is before the first field measurement for a particular point then the interpolated value is the first measurement. Similarly if the model output time is after the last field measurement then the interpolated value is the last measurement. When the model output time is between the first and last measurement then GMS will find the 2 closest field measurements to the model output time and use linear interpolation to compute the

"observed" value at that time.

MODFLOW errors

The *Error Summary Plot* is most useful with models that do not make error computations from observation data. MODFLOW does compute error computations from observation data, and these errors are available in the [MODFLOW Properties dialog](#). Therefore, when using MODFLOW, you should use the *MODFLOW Properties* dialog and not the *Error Summary Plot*. The errors shown in the *Error Summary Plot* are not the same as those found in the *MODFLOW Properties* dialog due to the time matching and interpolation issues described above. The *MODFLOW Properties* dialog shows the errors computed by MODFLOW for the observations at the actual observation times and is therefore superior. The errors reported by MODFLOW have nothing to do with the model output times, only observation times.

Plot creation

Error Summary plots are created in the *Plot Wizard* by setting the plot type to *Error Summary*. A sample plot is shown in the figure.

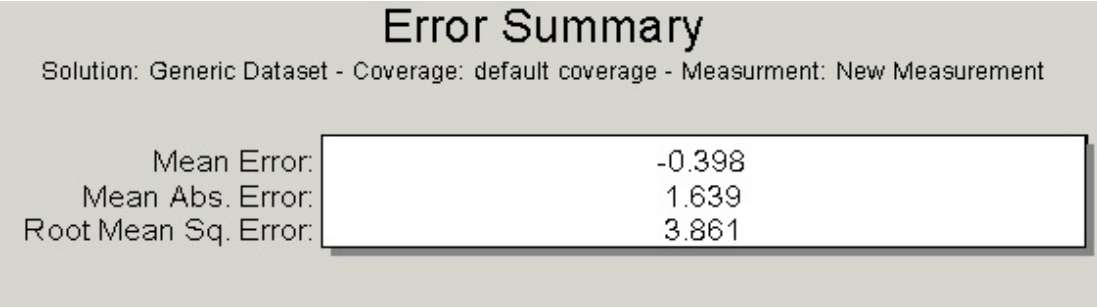

The image shows a dialog box titled "Error Summary" with a light gray background. At the top, it reads "Solution: Generic Dataset - Coverage: default coverage - Measurement: New Measurement". Below this, there is a table with three rows of error statistics. The first row is "Mean Error:" with a value of "-0.398". The second row is "Mean Abs. Error:" with a value of "1.639". The third row is "Root Mean Sq. Error:" with a value of "3.861". The table is enclosed in a black border.

Error Summary	
Solution: Generic Dataset - Coverage: default coverage - Measurement: New Measurement	
Mean Error:	-0.398
Mean Abs. Error:	1.639
Root Mean Sq. Error:	3.861

3D Grid Cell Properties dialog showing the MT3DMS tab.

Error Summary Plot Options

After the plot type is set in the first step of the *Plot Wizard*, the **Next** button is clicked to move to the second step of the *Plot Wizard*.

- *Coverage*: Displays the name of the coverage where the current data for the plot is coming from.
- *Measurement*: This is the name of the current measurement, created in the *Feature Objects | Attributes* dialog, being plotted.
- *Feature Objects*: Displays which feature object is utilized in the current plot, points or arcs.

Zone Budget

In previous versions of GMS, it has been possible to view a detailed MODFLOW flow budget for a set of selected cells using the **Flow Budget** command in the *Data* menu. Now, the flow budget can be summarized based on user-defined zones. This provides a capability quite similar to the USGS ZoneBudget tool. However, the calculations are all done inside GMS using the CCF (Cell-to-Cell Flow) file generated by MODFLOW.

The Zone Budget Utility is included with all [paid editions](#) of GMS.

Defining Zones

The first step in using this utility is to identify the model zones by assigning a zone budget id to each of the cells in the grid. The zone budget id is an integer value. It can be associated with polygons in a MODFLOW conceptual model in the map module. The *zone budget id* property is listed in the *Areal Properties* column of the *Coverage Setup* dialog. These IDs are then assigned to the appropriate grid cells when the **Map**→**MODFLOW** command is selected. The IDs can also be assigned directly to cells by selecting a set of cells and selecting the **Cell Properties** command in the *MODFLOW* menu.

A *Zone Budget IDs* item is also included just below the MODFLOW icon in the [Project Explorer](#) window. Clicking on this icon displays the zone budget IDs and double-clicking brings up the zone budget id array in the spreadsheet editor.

Viewing the Flow Budget

Once the zone budget IDs have been assigned, the flow budget for each zone can be viewed by selecting the **Flow Budget** command in the *MODFLOW* menu. This brings up the *Flow Budget* dialog. There is a *new zone selector* combo box at the top of the dialog. The flow budget associated with the selected zone is shown in the table. The combo box includes an "All zones" option that displays a summary for all zones in the model. Also, turning on the *Use all time steps toggle* will create a flow budget report for each time step in the current MODFLOW solution.

Flow Budget

Cells Zones **USGS_ZONEBUDGET**

Zone Use all

Budget Term	Flow (ft ³ /d)
Flow Budget for Zone 1	
IN:	
CONSTANT HEAD	0.0
WELLS	0.0
DRAINS	0.0
RECHARGE	699635.61035156
Zone 2 to zone 1	66487.0078125
Total IN	766122.61816406
OUT:	
CONSTANT HEAD	162494.02429199
WELLS	146760.0
DRAINS	312877.63085938
RECHARGE	0.0
Zone 1 to zone 2	143943.11752319
Total OUT	766074.77267456
SUMMARY:	
IN - OUT	47.845489501953
Percent Discrepancy	0.0062453427722

Flow Budget dialog showing the Zones tab.

Viewing in a Plot File

For a transient model a user may use the flow budget vs. time plot to view the flow budget for any number of cells.

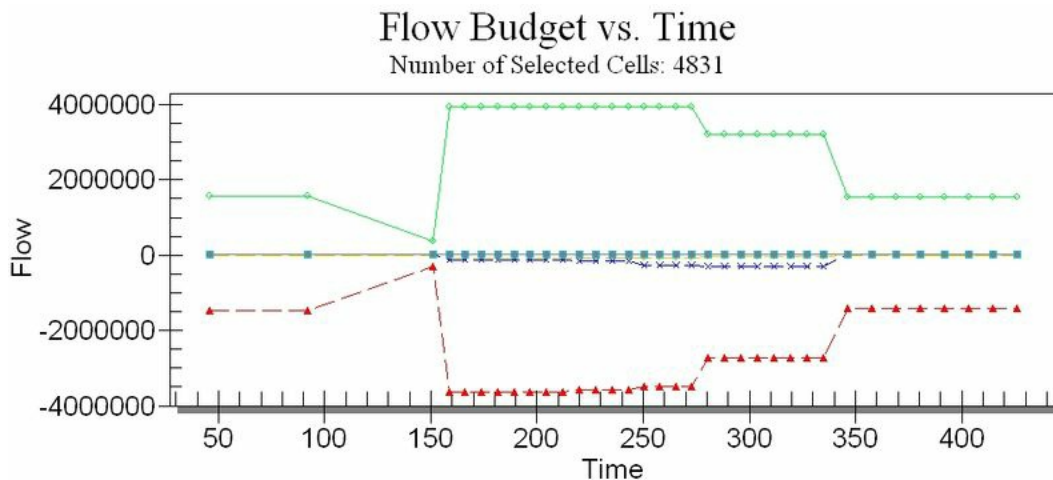

By right-clicking on the plot and select the view values option, GMS will generate a table of the flow budget for the different time steps.

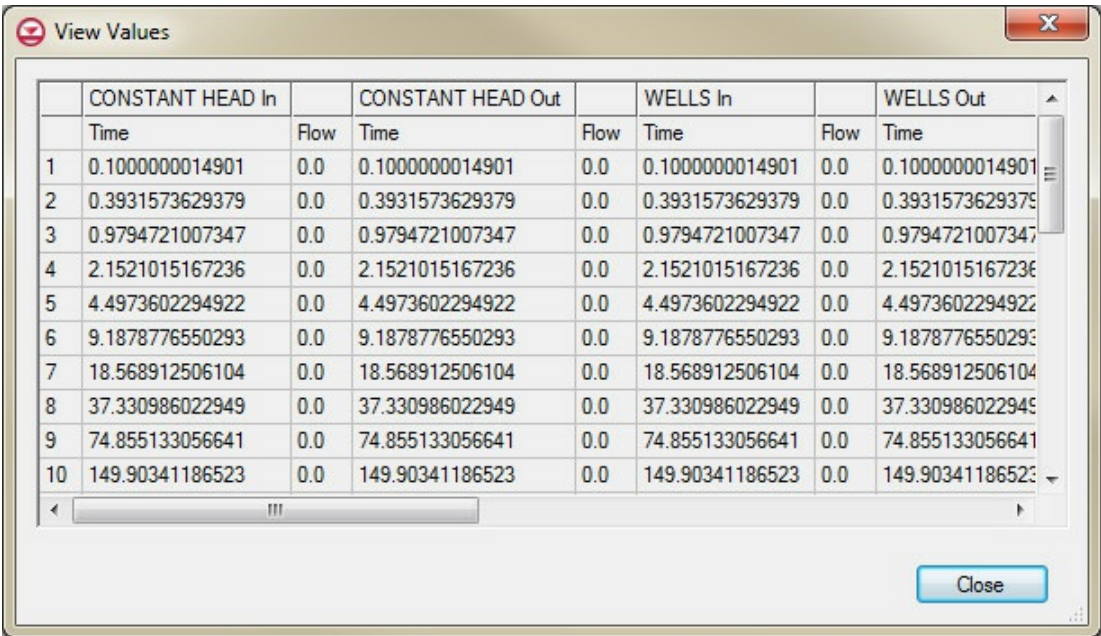

	CONSTANT HEAD In		CONSTANT HEAD Out		WELLS In		WELLS Out	
	Time	Flow	Time	Flow	Time	Flow	Time	Flow
1	0.1000000014901	0.0	0.1000000014901	0.0	0.1000000014901	0.0	0.1000000014901	0.0
2	0.3931573629379	0.0	0.3931573629379	0.0	0.3931573629379	0.0	0.3931573629379	0.0
3	0.9794721007347	0.0	0.9794721007347	0.0	0.9794721007347	0.0	0.9794721007347	0.0
4	2.1521015167236	0.0	2.1521015167236	0.0	2.1521015167236	0.0	2.1521015167236	0.0
5	4.4973602294922	0.0	4.4973602294922	0.0	4.4973602294922	0.0	4.4973602294922	0.0
6	9.1878776550293	0.0	9.1878776550293	0.0	9.1878776550293	0.0	9.1878776550293	0.0
7	18.568912506104	0.0	18.568912506104	0.0	18.568912506104	0.0	18.568912506104	0.0
8	37.330986022949	0.0	37.330986022949	0.0	37.330986022949	0.0	37.330986022949	0.0
9	74.855133056641	0.0	74.855133056641	0.0	74.855133056641	0.0	74.855133056641	0.0
10	149.90341186523	0.0	149.90341186523	0.0	149.90341186523	0.0	149.90341186523	0.0

View Values dialog

Viewing the MODFLOW CCF File

There are two new options to view MODFLOW cell-to-cell flow (CCF) file output:

1. The CCF file can be viewed in a spreadsheet by right-clicking on the CCF file  in the [Project Explorer](#) and selecting the **View Values** command.
2. The CCF file can also be converted to a set of datasets. One dataset would be created for drains (if they exist), one for rivers etc., and three for cell-to-cell flow (flow right, flow back, flow down).

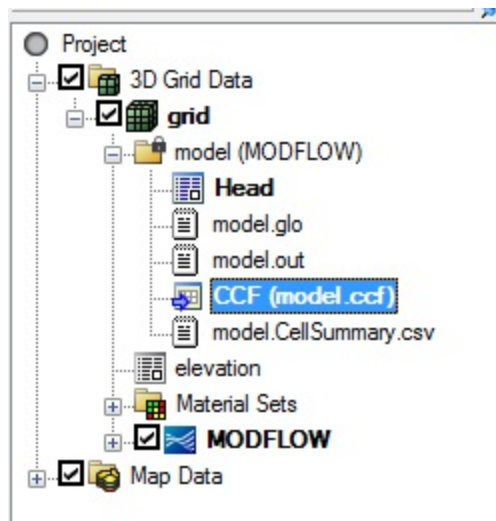

CCF datasets displayed in the [Project Explorer](#)

ZONEBUDGET

ZONEBUDGET is USGS program that reads cell to cell flow data produced by MODFLOW and calculates water budgets for subregions of the modeled area. GMS has an interface to ZONEBUDGET available from the *MODFLOW* | **Flow Budget** menu command. This command brings up the *Flow Budget* dialog and one of the available tabs in the dialog is *USGS ZONEBUDGET*. GMS supports version 3.01 of ZONEBUDGET.

When the user brings up the *ZONEBUDGET* tab they will be analyzing the CCF (Cell-to-Cell Flow) file from the active MODFLOW solution. All ZONEBUDGET inputs and outputs will be written to the same location as the CCF file.

GMS has its own internal tools for analyzing CCF data. These tools are explained the article [Zone Budget](#).

ZONEBUDGET Options

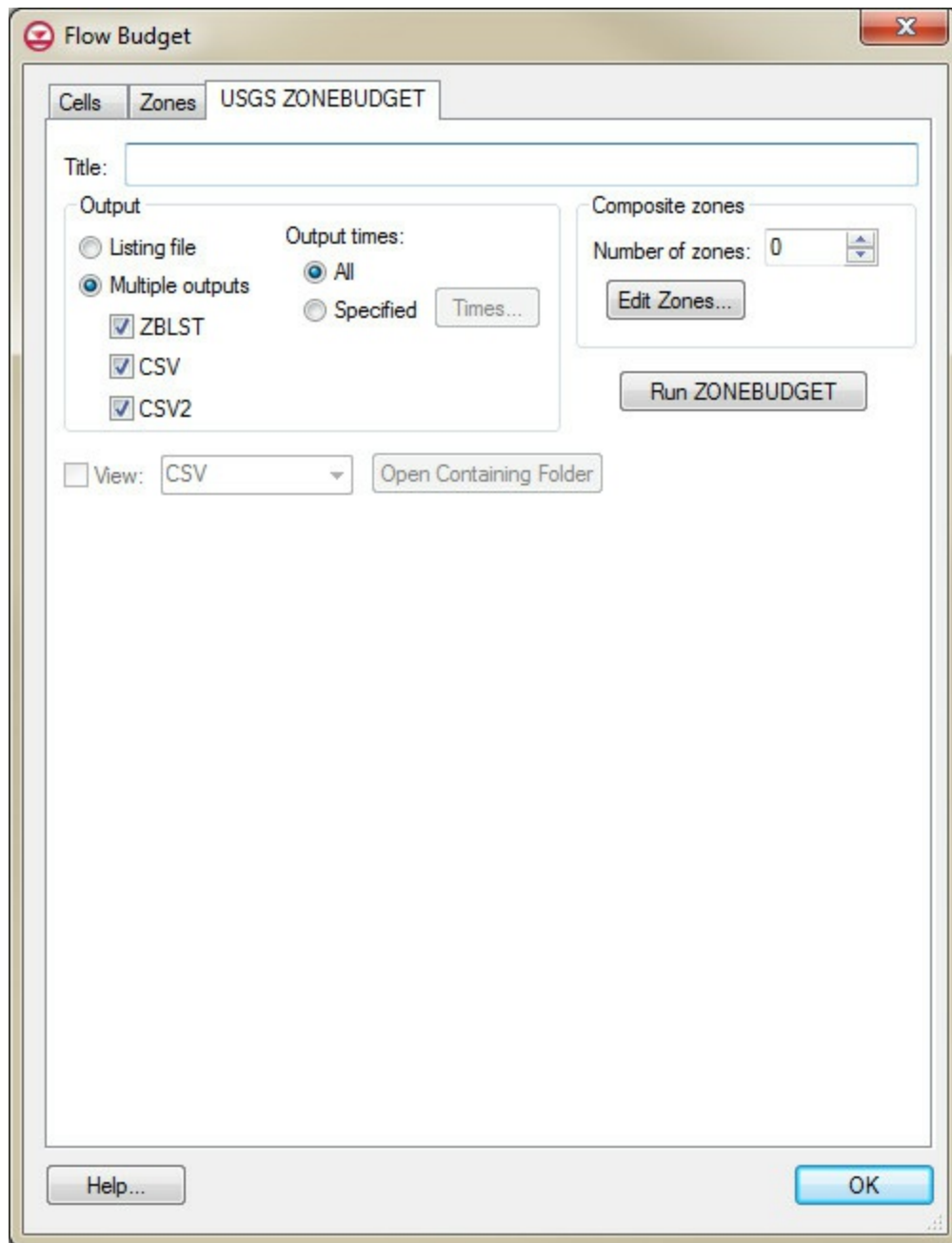

Flow Budget dialog showing the USGS ZONEBUDGET tab.

- **Title** – This is a title that is printed to the listing output file.
- **Output**
 - *Listing File* – This specifies that ZONEBUDGET will produce a listing file as output. This was the only kind of output that the first version of ZONEBUDGET produced.
 - *Multiple Outputs* – Version 3 of ZONEBUDGET has the option to produce multiple output files.
 - *ZBLST* – ZONEBUDGET will create a listing file as part of its output.
 - *CSV* – ZONEBUDGET will create a comma separate value (CSV) file as part of its output. For each time for which a budget is requested there is one line for each input term and each output term along with totals. The zones are displayed in columns, so one table displays all zones. This makes it easy to

compare any budget term for all the different zones.

- CSV2 – ZONEBUDGET will create another CSV file as part of its output. The CSV2 file displays the complete budget for one zone and one time in a single line. Each column has a separate inflow or outflow budget term. The rows can be sorted by time within the spreadsheet program, which makes it possible to easily see how each term changes with time.

- *Output times*

- *All* – Every time step in the MODFLOW CCF file will be processed.
- *Specified* – With this option selected the user can select individual time steps from the CCF file for ZONEBUDGET to process. When the user clicks on the **Times** button a spread sheet comes up that allows the user to select the time steps.

- **Composite Zones** – ZONEBUDGET allows users to combine zones into "Composite Zones" and then information about the composite zone is printed to the listing file.

- *Number of zones* – This specifies the number of composite zones.
- **Edit Zones** – This button brings up a dialog where the user can create composite zones. A composite zone is defined by a name that is 10 characters or less in length and a list of the zone ids separated by a comma. For example, when analyzing a model with zones 1, 2, 3, and 4, composites zone could be defined as follows:

Name	Zone IDs
zone_top	1, 2
zone_bot	3, 4

- **Run ZONEBUDGET** – This launches ZONEBUDGET with the specified input options.
- **View** – This allows the user to load ZONEBUDGET outputs. The options available include LST, ZBLST, CSV, and CSV2. The contents of the output file are loaded into a text window or a spread sheet in the space below the View check box.
- **Open Containing Folder** – This button brings up Windows Explorer opened to the directory with the ZONEBUDGET output.

Viewing Computed Fluxes

Once a set of observed flows has been entered, the next step is to run the MODFLOW model, read in the solution, and compare the computed flows to the observed flows. The computed flows are part of the MODFLOW output.

Summation of Fluxes on Arcs and Polygons

GMS writes the necessary files so that MODFLOW will output the computed flow for boundary conditions created in the Map module. These computed flows can be viewed by selecting the appropriate feature object (river arc, etc) and then looking at the [Status Bar](#). For an object with an assigned observed flow, the observed flow value and the residual error are displayed in addition to the computed flow. For objects without an observed flow, only the computed flow is shown.

Calibration Targets and Statistics

For objects with an observed flow, a calibration target can be plotted on the object. The calibration target provides a graphical representation of the calibration error. Calibration targets are described in section 14.5. The display of flow calibration targets is turned on by selecting the **Display Options** command in the *Feature Objects* menu when the local source/sink coverage is the active coverage.

Flow Budget for Selected Cells

If a MODFLOW model is built without using the conceptual model approach (directly from the grid), the computed fluxes corresponding to a user-defined set of cells can still be displayed. This is accomplished by selecting a set of cells and selecting the **Flow Budget** command from the *Data* menu in the 3D Grid module. This command brings up the *Flow Budget* dialog. This dialog lists the complete flow budget for the selected cells. Flow units

are in length cubed per day (ft^3/d for example) determined from the *Edit* | **Units** window.

6.5. MODPATH

MODPATH

MODPATH is a particle tracking code that is used in conjunction with [MODFLOW](#). After running a MODFLOW simulation, the user can designate the location of a set of particles. The particles are then tracked through time assuming they are transported by advection using the flow field computed by MODFLOW. Particles can be tracked either forward in time or backward in time. Particle tracking analyses are particularly useful for delineating capture zones or areas of influence for wells.

A complete description of MODPATH is beyond the scope of this help file, however, because of the user-friendly interface in GMS, an intimate knowledge of MODPATH is not required to effectively do particle tracking in GMS. For a more complete knowledge of MODPATH, refer to the MODPATH documentation (Pollock, 1994).

MODPATH was developed by the U.S. Geological Survey. Version 5.0 of MODPATH is supported in GMS. The version of MODPATH distributed with GMS is the original public domain version distributed by the USGS, with minor modifications to accommodate GMS. The MODPATH model is included with all [paid editions](#) of GMS.

MODPATH Files

Here are tables of some of the available files for MODPATH.

- For more information on these files see the [manual](#)

MODPATH Files

Name	Description
EPT	Endpoint File
LOC	Starting Locations File
MDF	Main Data File
NAM	Name File
PTH	Particle Path File
RSP	Response File
SUM	Summary File

MODPATH Links

- [MODPATH Particle Tracking](#)
- [MODPATH Particle Sets](#)
- [MODPATH Zone Codes](#)
- [MODPATH Display Options](#)
- [Exporting Pathlines](#)

MODPATH Particle Tracking

Requirements

Before modeling particle tracking with MODPATH, there must be:

1. A MODFLOW simulation in memory.
2. A MODFLOW solution in memory computed using MODFLOW 2000 with a valid head and flow field.

If the [Conceptual Model](#) approach is used to build the [MODFLOW](#) model, the same conceptual model can be used to initialize some of the input data for MODPATH. Both the zone codes and porosities can be defined using polygons in a MODFLOW / MT3D / MODPATH Layer Attributes type coverage. The values are assigned to the cells when the **Map** → **MODPATH** command is selected.

Steps

Once there is a MODFLOW solution, all that is necessary to do particle tracking is to:

1. Create particle starting locations.

As soon as the user creates the particle starting locations GMS immediately does a number of things depending on the *Run MODPATH automatically for steady state models* option in the *MODPATH General Options* dialog. If the option is on and the MODFLOW model is steady state.

Automatic option on

1. GMS saves the MODPATH input files.
2. GMS launches MODPATH and passes it the input files.

3. GMS waits for MODPATH to compute the pathlines.
4. GMS then reads in and displays the pathlines.

All this is done automatically and behind the scenes and usually takes just a second or two. Thus, pathlines will appear almost immediately after defining the particle starting locations. If MODPATH encountered problems attempting to generate the path lines, the errors will be displayed in the *MODPATH Errors* dialog.

Automatic option off

If the *Run MODPATH automatically for steady state models* option is off, or the MODFLOW model is transient, save and run MODPATH manually after creating particle starting locations before pathlines will appear. This is to prevent having GMS spend lots of time updating pathlines because MODPATH can take a considerable amount of time with large, transient models. The *MODPATH | Run MODPATH* menu command or equivalent toolbar macro can be used to run MODPATH.

Generating Particles

There are three ways to generate particle starting locations in GMS, with two available via the *MODPATH* menu:

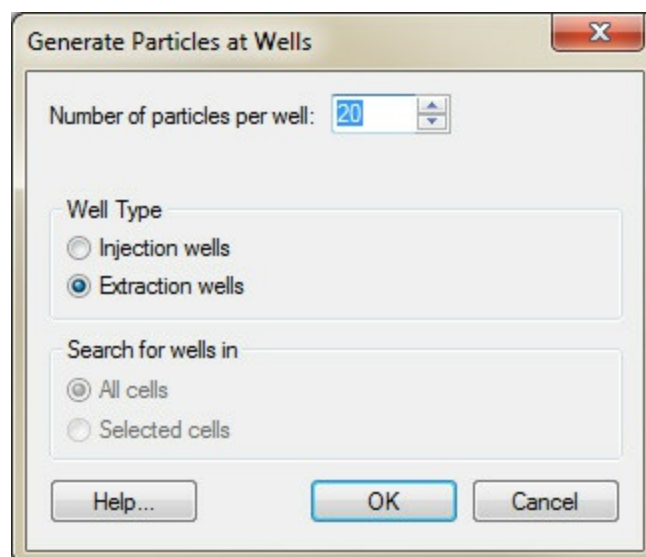

Generate Particles at Wells dialog.

1. **Generate Particles at Wells** – Accessed in the *MODPATH* menu. This command automatically generates particle starting locations in cells containing wells. The specified number of particle starting locations are distributed evenly in a horizontal circle around the center of the cells containing the wells. Specify the number of starting locations per cell, and whether the user wants starting locations created in extraction well cells, or injection well cells.
 - *Injection Wells* – If this option is selected, particles are created in cells with wells that have a positive flow rate. The tracking direction for the current particle set is changed to forward.
 - *Extraction Wells* – If this option is selected, particles are created in cells with wells that have a negative flow rate. The tracking direction for the current particle set is changed to backward.
 - *Selected Wells* – This option makes it possible to generate particles at either all wells or only at wells within selected cells.

2. **Generate Particles at Selected Cells** – Accessed in the *MODPATH* menu. This command opens the *Generate Particles* dialog, and when selecting **OK**, particles are created in all the selected cells according to the options specified.
 - *Number of Particles* – If the *More options* toggle is not selected, the user can use the slider to change the number of particles created per cell. The minimum is 1, and the maximum depends on the option being used to distribute the particles. The number of particles jumps as the slider is moved in order to create an even distribution of particles. If the *More options* toggle is selected, the slider is not available, and the user has more control over the total number of particles and how they are distributed.
 - *Distribute Particles* – There are three options for distributing the particles within the selected cells. These commands are only available if a MODFLOW CCF solution generated by MODFLOW 2000 exists, and 3D grid cells are selected.
 - *Within Cell* – With this option, the particles are distributed in the interior of the cells.
 - *On Cell Faces* – With this option, the particles are distributed on the faces of the cells.
 - *Distribute Starting Points on Water Table Surface* – With this option, the particles are restricted to the top face only. When using this option, be sure to select the cells corresponding to the location of the water table surface.
 - *More Options* – The *More options* toggle expands the dialog, allowing the user to further define how particles are distributed within the selected cells.

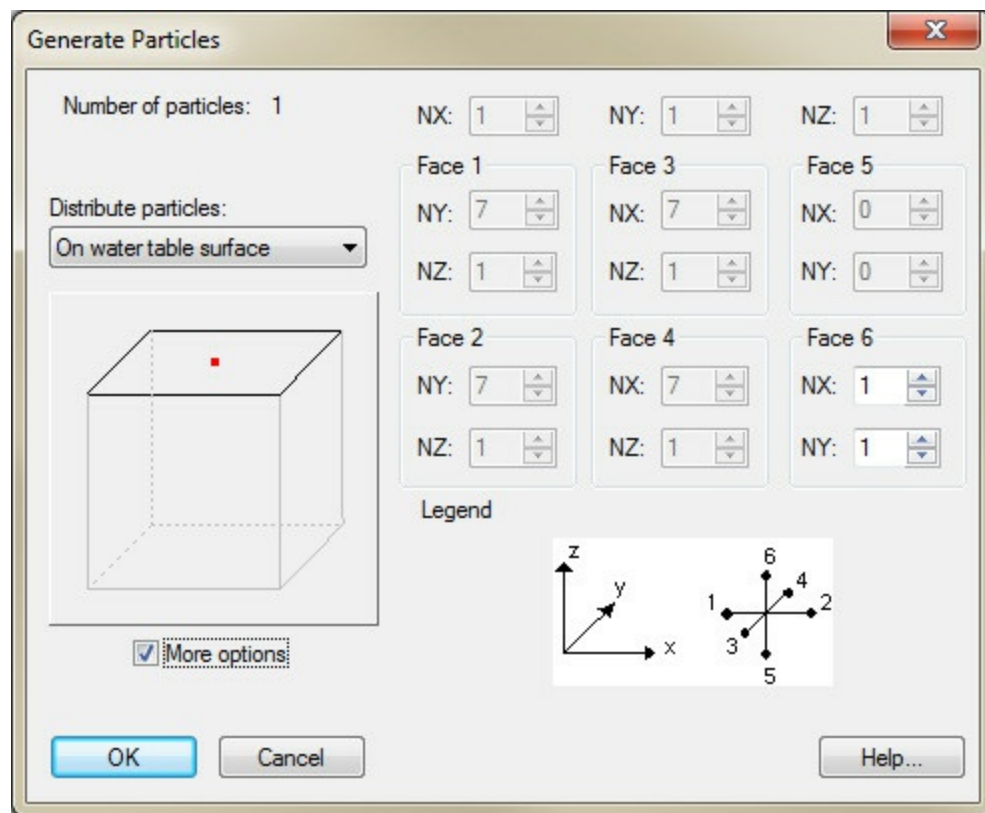

Example of the Generate Particles dialog.

3. **Converting 3D Scatter Set** – This option is accessed by right-clicking on a created 3D Scatter Set in the Project Explorer and clicking *Convert To | MODPATH Starting Locations*.

Transient MODFLOW Solution

For each time step, particle paths are computed just as for the steady state case until the end of the time step is reached. A new velocity distribution is then calculated for the next time step and the computation of particle paths is resumed. The computation of paths forward or backward, boundary conditions, and the path line termination criteria are handled the same as for steady state flow.

MODPATH Particle Sets

MODPATH particles are grouped into sets. For each set, specify the name of the set, the tracking direction, the tracking duration, and if the particles in the set should be displayed.

Grouping particles into sets increases the power and flexibility of particle tracking. For example, several particle sets, some tracking backward and some forward can all be displayed at once. Or, several particle sets, each with different tracking times, can all be displayed at the same time. This can be used to show nested capture zones.

Active Particle Set

One particle set is always designated as the active particle set, and there is never more than one active particle set. Whenever particles are created, they are added to the active particle set. Particles can only be deleted from the active particle set—to delete particles in a particle set that is not active, it's necessary first make it active.

Order

The order that particle sets are listed in the Project Explorer corresponds to the order they are displayed. Thus, particle sets that are listed at the top are displayed on top of particle sets listed further down. The order can be changed by dragging the particle sets.

Creation / Deletion

If a particle set is deleted, all the particles in the set are deleted.

If there are no particle sets, and when the user creates particles, a particle set is automatically created.

Pathline Export

See [Exporting Pathlines](#).

Spreadsheet Report

In addition to the text file export, there is an option for generating a tabular report directly within GMS. This report is accessed by right-clicking on a particle set in the [Project Explorer](#) and selecting the **View Pathline Report** command. This command brings up the *View Pathline Report* dialog:

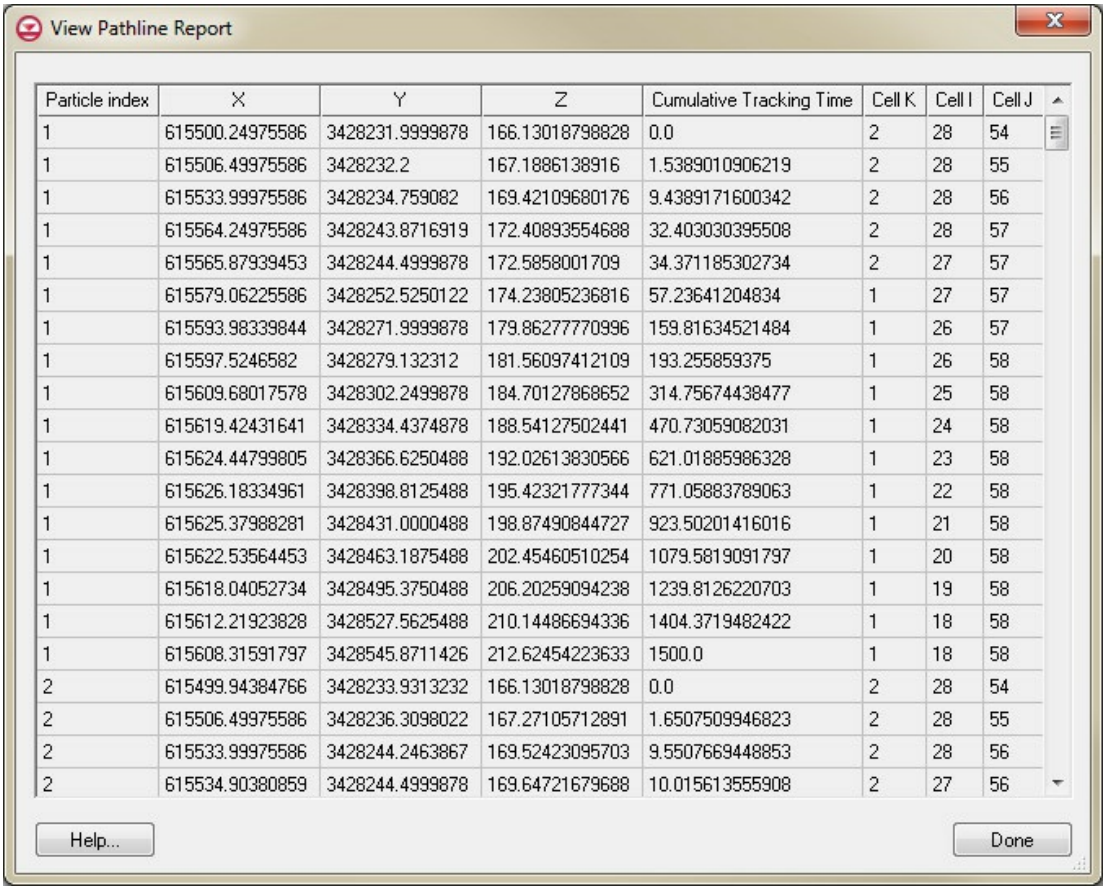

The screenshot shows a dialog box titled "View Pathline Report" with a close button (X) in the top right corner. The dialog contains a table with the following columns: Particle index, X, Y, Z, Cumulative Tracking Time, Cell K, Cell I, and Cell J. The table lists 28 rows of data, with particle indices ranging from 1 to 2. The X, Y, and Z columns contain numerical coordinates. The Cumulative Tracking Time column shows values increasing from 0.0 to 10.015613555908. The Cell K, Cell I, and Cell J columns show cell identifiers, with Cell K values ranging from 1 to 2, and Cell I and Cell J values ranging from 18 to 58. At the bottom of the dialog, there are "Help..." and "Done" buttons.

Particle index	X	Y	Z	Cumulative Tracking Time	Cell K	Cell I	Cell J
1	615500.24975586	3428231.9999878	166.13018798828	0.0	2	28	54
1	615506.49975586	3428232.2	167.1886138916	1.5389010906219	2	28	55
1	615533.99975586	3428234.759082	169.42109680176	9.4389171600342	2	28	56
1	615564.24975586	3428243.8716919	172.40893554688	32.403030395508	2	28	57
1	615565.87939453	3428244.4999878	172.5858001709	34.371185302734	2	27	57
1	615579.06225586	3428252.5250122	174.23805236816	57.23641204834	1	27	57
1	615593.98339844	3428271.9999878	179.86277770996	159.81634521484	1	26	57
1	615597.5246582	3428279.132312	181.56097412109	193.255859375	1	26	58
1	615609.68017578	3428302.2499878	184.70127868652	314.75674438477	1	25	58
1	615619.42431641	3428334.4374878	188.54127502441	470.73059082031	1	24	58
1	615624.44799805	3428366.6250488	192.02613830566	621.01885986328	1	23	58
1	615626.18334961	3428398.8125488	195.42321777344	771.05883789063	1	22	58
1	615625.37988281	3428431.0000488	198.87490844727	923.50201416016	1	21	58
1	615622.53564453	3428463.1875488	202.45460510254	1079.5819091797	1	20	58
1	615618.04052734	3428495.3750488	206.20259094238	1239.8126220703	1	19	58
1	615612.21923828	3428527.5625488	210.14486694336	1404.3719482422	1	18	58
1	615608.31591797	3428545.8711426	212.62454223633	1500.0	1	18	58
2	615499.94384766	3428233.9313232	166.13018798828	0.0	2	28	54
2	615506.49975586	3428236.3098022	167.27105712891	1.6507509946823	2	28	55
2	615533.99975586	3428244.2463867	169.52423095703	9.5507669448853	2	28	56
2	615534.90380859	3428244.4999878	169.64721679688	10.015613555908	2	27	56

View Pathline Report dialog

MODPATH Zone Codes

When post-processing the results of the MODPATH simulation, the colors of the paths or particles can be varied depending on the zone code of the cell in which the particle started or in which the particle terminated. Zone codes are assigned using the IBOUND array in the MODFLOW interface. In other words, unique values of the IBOUND array (100, 200, 300, etc.) are assigned to the cells of the grid to define the zone codes. The zone code array can be edited by clicking on the **Zone Code Array** command in the *MODPATH* menu. This command is only available if a MODFLOW simulation exists.

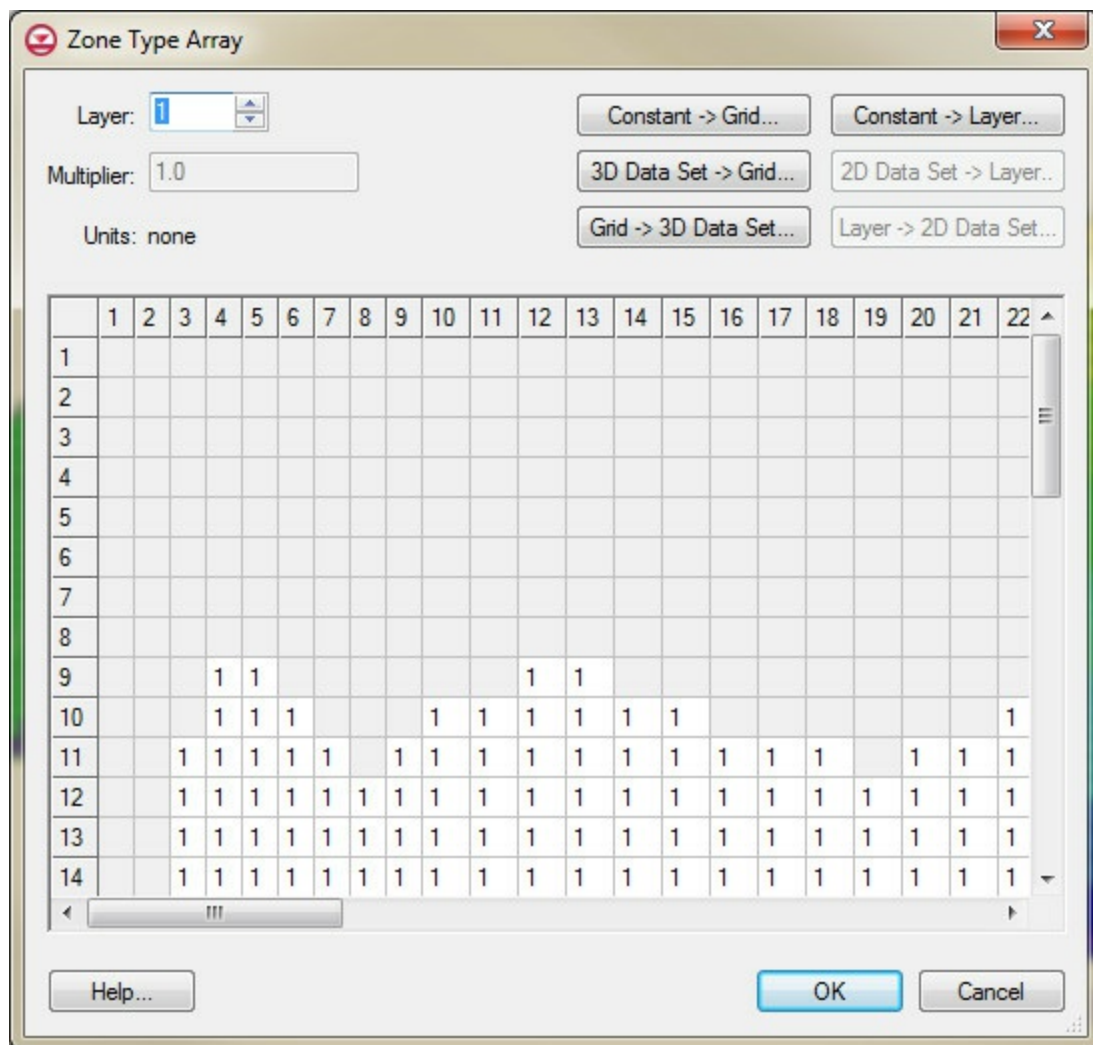

Zone Type Array dialog

Cell Properties

The *Zone Code* for each cell can also be edited by selecting a cell and then choosing the **Cell Properties** command from the *MODPATH* menu. In addition to the zone code, cell porosity can be edited in the *3D Grid Cell Properties* dialog.

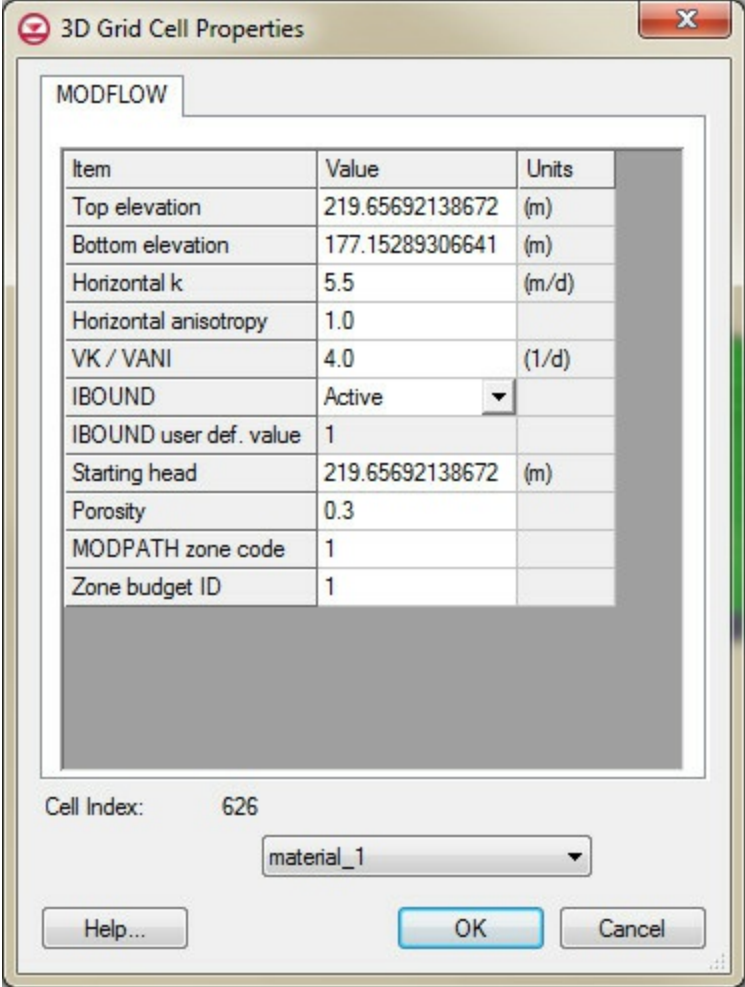

3D Grid Cell Properties dialog showing the MODFLOW tab.

Related Topics

- [MODPATH Commands](#)

MODPATH Display Options

A set of display options unique to the MODPATH input data and MODPATH solutions is provided in GMS. These options are accessed through the **Display Options** command in the *MODPATH* menu. This command is only available if a MODFLOW simulation exists. This command brings up the *Particles* tab of the *3D Grid Display Options* dialog. The following table describes the display options available for the MODPATH model.

Display Option	Description
Starting locations	The <i>starting locations</i> for the particles can be turned on and off. The symbol style, color and size can also be adjusted.
Starting location indices	The <i>starting locations indices</i> for the particles can be turned on and off. The font style, color and size can also be adjusted.
Ending locations	The <i>ending locations</i> for the particles can be turned on and off. The symbol style, color and size can also be adjusted.
Pathlines	The <i>pathlines</i> can be toggled on and off, and the pathline style and color can be adjusted. The pathline color can be set to the default color, or the color corresponding to the starting, ending, or cell zone codes of the pathlines. The <i>Cell zone code</i> option causes the pathline to change color as it passes through cells with different zone codes.
Direction arrows	<i>Direction arrows</i> can be displayed along the pathlines. The size of the arrow heads can be set by specifying the <i>Length</i> in pixels. The arrows are displayed along the pathline at an interval corresponding to the <i>Length</i> specified.
Zone codes	Colors can be associated with zone codes. If the <i>Auto compute colors</i> option is selected, GMS will automatically pick colors to go with each unique zone code. Otherwise, the user can specify the color desired to associate with each zone code. These colors are used if the <i>Pathline Color</i> option is set to "Starting zone" code or "Ending zone" code.
Capture zones	GMS groups pathlines together into capture zones. A polygon representing the outer boundary of the pathlines is found and can be outlined, or filled. The following options are available relating to the capture zones: <ul style="list-style-type: none">• <i>Delineate by well</i> With this option, all the pathlines originating from a cell containing a well will be grouped together into one capture zone. All wells with the same name are included in the same capture zone.• <i>Delineate by zone code</i> With this option, all pathlines originating from the same zone code are grouped together into capture zones. This option could be used to create a single capture zone for several wells that have different names. The cells containing the wells would need to be assigned the same zone code. This option could also be used to find the "capture zone" for a zone of cells where the cells all have the same zone code.• <i>Thin triangle ratio</i> GMS triangulates the pathlines in a capture zone to determine the capture zone boundary. Depending on the length and shape of the pathlines, it may be necessary to adjust the Thin triangle ratio to get a good looking capture zone. Increasing the value causes more area around the edges to be included. Decreasing the value causes less area around the edges to be included.

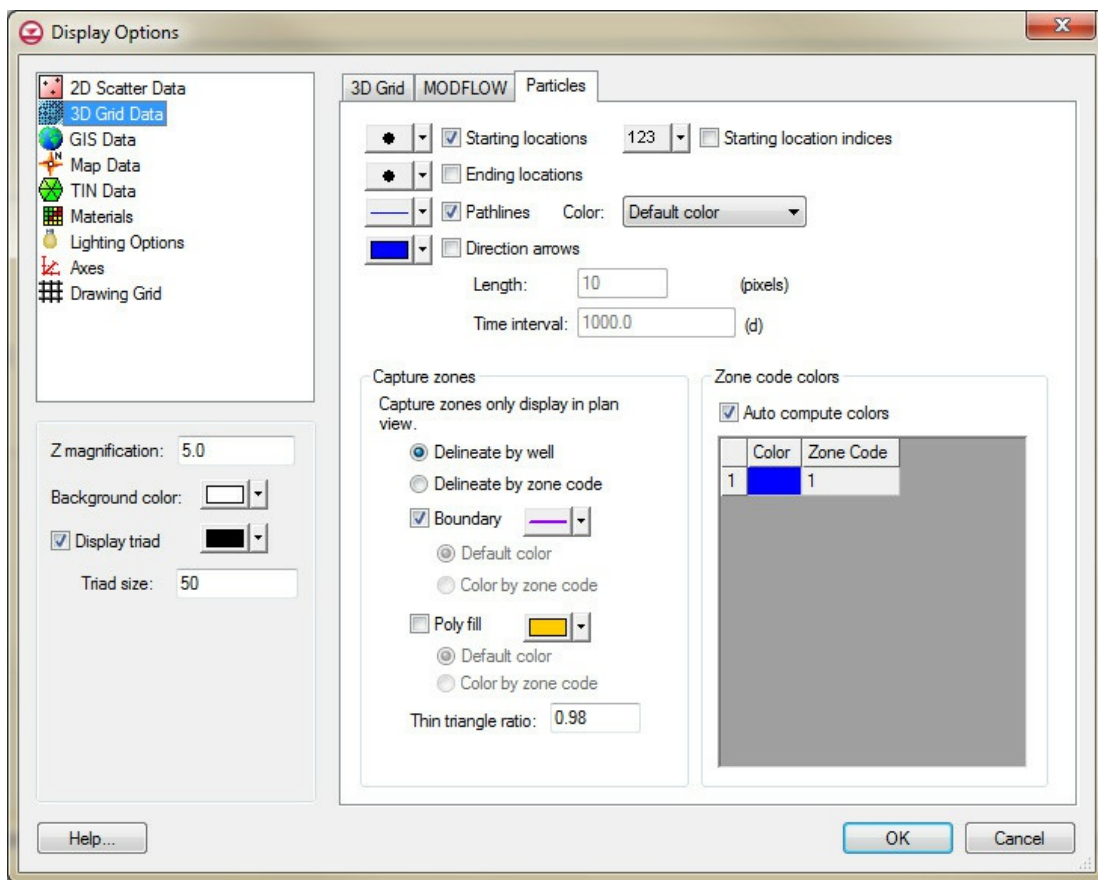

The Display Options dialog showing the Particle tab in the 3D Grid Data item.

Exporting Pathlines

MODPATH pathlines can be exported from GMS in a few different ways:

Capture Zones to Arcs

The *MODPATH* | **Capture Zones** → **Arcs** command will convert the capture zone outline to [feature arcs](#), creating a separate [coverage](#) for each well. Coverages can be [exported as a shapefile](#) or [converted to CAD](#) data. Capture zones are defined using the *Delineate by well* and *Delineate by zone code* options in the [MODPATH Display Options](#) dialog.

Pathlines to Arcs

The *MODPATH* | **Pathlines** → **Arcs** command works similar to the *MODPATH* | **Capture Zones** → **Arcs** but instead of converting the capture zone boundary, all of the pathlines in the capture zone are converted.

Starting Locations to 3D Scatter Points

Starting locations can be converted to [3D scatter points](#) and [vice versa](#). If the *MODPATH* | **Starting Locations** → **3D Scatter Points** menu command is selected, a new 3D scatter point set will be created from each particle set that is visible. If the command is executed by right-clicking on a [particle set](#)  in the [Project Explorer](#), a new 3D scatter point set will be created from only that particle set.

Tab delimited file

Pathlines can be exported by right-clicking on a particle set in the [Project Explorer](#) and selecting the **Export** option. This saves the pathline geometry to a tab-delimited text file that can be imported directly into Excel:

	A	B	C	D	E
1	Particle Index	X	Y	Z	Time
2	1	2759.749707	4673.000293	642.5853882	0
3	1	2778.499707	4675.989063	642.9729004	10.16185188
4	1	2860.999707	4698.607715	646.5800781	59.94756317
5	1	2889.394238	4710.500293	648.5951538	89.09955597
6	1	2951.749707	4762.960742	655.4408569	199.6464691
7	1	2989.360547	4793.000293	659.4976807	277.4127808
8	1	3051.574658	4865.093555	670.4102783	457.3159485
9	1	3070.031934	4883.750293	673.9478149	514.0853882
10	1	3152.77583	4983.575488	695.2171631	833.0230103
11	1	3161.382275	4995.122363	698.9933472	871.7883301
12	1	3183.180371	5020.475391	706.703064	971.0857544
13	2	2758.831982	4678.794238	642.5853882	0
14	2	2778.499707	4688.078906	643.0006714	10.88638687
15	2	2842.216748	4710.500293	645.999939	45.19052124
16	2	2860.999707	4734.410449	649.6905518	72.89888
17	2	2931.588574	4793.000293	655.0541382	189.3552246
18	2	2951.749707	4821.638965	659.7767944	242.1230316
19	2	3009.110303	4883.750293	667.6638794	399.1149292
20	2	3051.574658	4943.287891	678.0623169	554.4108887
21	2	3087.816357	4983.575488	686.4725342	689.6051636
22	2	3116.907178	5056.291797	706.2245183	851.8782959

Right-clicking on the particle set data folder and selecting the **Export** command will generate tab-delimited text file with all particle sets in the data folder included in the file.

Spreadsheet report

The user can bring up a spreadsheet report showing the pathline XYZ data in GMS. See [MODPATH Particle Sets, Spreadsheet Report](#).

MODPATH Commands

When the MODPATH model is active, the *MODPATH* menu becomes available. The menu has the following commands:

Display Options...

Brings up the *Display Options* dialog.

Generate Particles at Wells...

This command automatically generates particle starting locations in cells containing wells. See [Generating Particles](#).

Generate Particles at Selected Cells...

This command opens the *Generate Particles* dialog. See [Generating Particles](#).

Cell Properties...

Opens the *3D Grid Cell Properties* dialog. To learn more, see [MODPATH Zone Codes](#).

Porosity...

Brings up the *Aquifer Layer Porosity* dialog.

Porosity Confining Beds...

Opens the *Confining Bed Porosity* dialog.

Zone Code Array...

Launches the *Zone Type Array* dialog. For more information, see [MODPATH Zone Codes](#).

General Options...

Brings up the *MODPATH General Options* dialog.

Capture Zone → Arcs

This command converts the capture zone outline to feature arcs. To learn more, see [Exporting Pathlines](#).

Pathlines → Arcs

Converts the all pathlines in the capture zone to feature arcs. For more information, see [Exporting Pathlines](#).

Starting Locations → 3D Scatter Points

This command converts starting locations to 3D scatter points. See [Exporting Pathlines](#)

to learn more.

Obsolete Commands

The following commands are no longer in the *MODPATH* menu in current versions of GMS:

Recompute Pathlines

Related Topics

- [MODPATH](#)

6.6. mod-PATH3DU

Mod-PATH3DU

The mod-PATH3DU model is a particle tracking program similar to [MODPATH](#) but designed to work with [MODFLOW-USG](#). GMS includes an interface that makes it easy to create mod-PATH3DU simulations, run them, and view the results.

Much of the mod-PATH3DU interface in GMS is similar to the MODPATH interface, but the mod-PATH3DU interface is not yet as fully developed. For example, mod-PATH3DU works more like other models in GMS in that the simulation must be saved and run and then the results are read and displayed, whereas in MODPATH this typically happens automatically whenever a change is made. In the future, more functionality will be added to the mod-PATH3DU interface in GMS.

Creating a Model

Creating a mod-PATH3DU model is taught in the mod-PATH3DU tutorial.

Requirements

There are three requirements for creating a mod-PATH3DU model:

1. The MP3DU component must be enabled.
2. A MODFLOW-USG model must exist. mod-PATH3DU only works with MODFLOW-USG (in GMS).
3. The MODFLOW-USG model must use the **Save native text copy** option.

Importing an Existing Model

GMS can import an existing mod-PATH3DU model. Open (or drag and drop) the *.mpsim file into GMS and the model will be imported.

Creating a New Model

To create a mod-PATH3DU simulation, right-click on a UGrid containing a MODFLOW-USG model and select the New mod-PATH3DU command. A mod-PATH3DU model icon will appear in the Project Explorer. Multiple mod-PATH3DU simulations can be created, with different starting locations and options.

Setting Options

Right-clicking the mod-PATH3DU model and selecting the **Options** command opens the *mod-PATH3DU Options* dialog. This dialog can be used to set various options such as the tracking direction.

Time Concepts

The following figure from the mod-PATH3DU documentation is useful for understanding time concepts in mod-PATH3DU and the time variables in the *mod-PATH3DU Options* dialog.

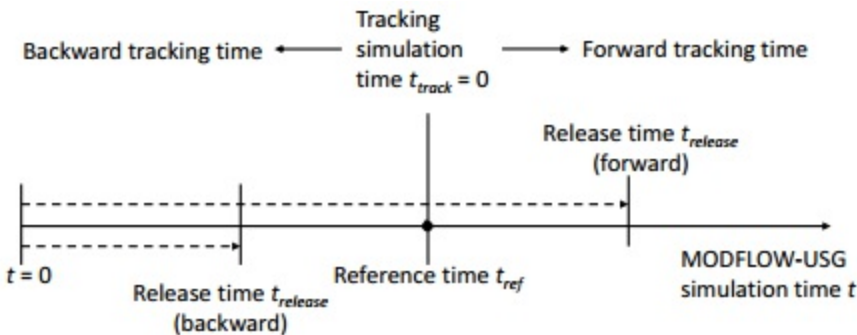

Time concepts in mod-PATH3DU

mod-PATH3DU Options Dialog

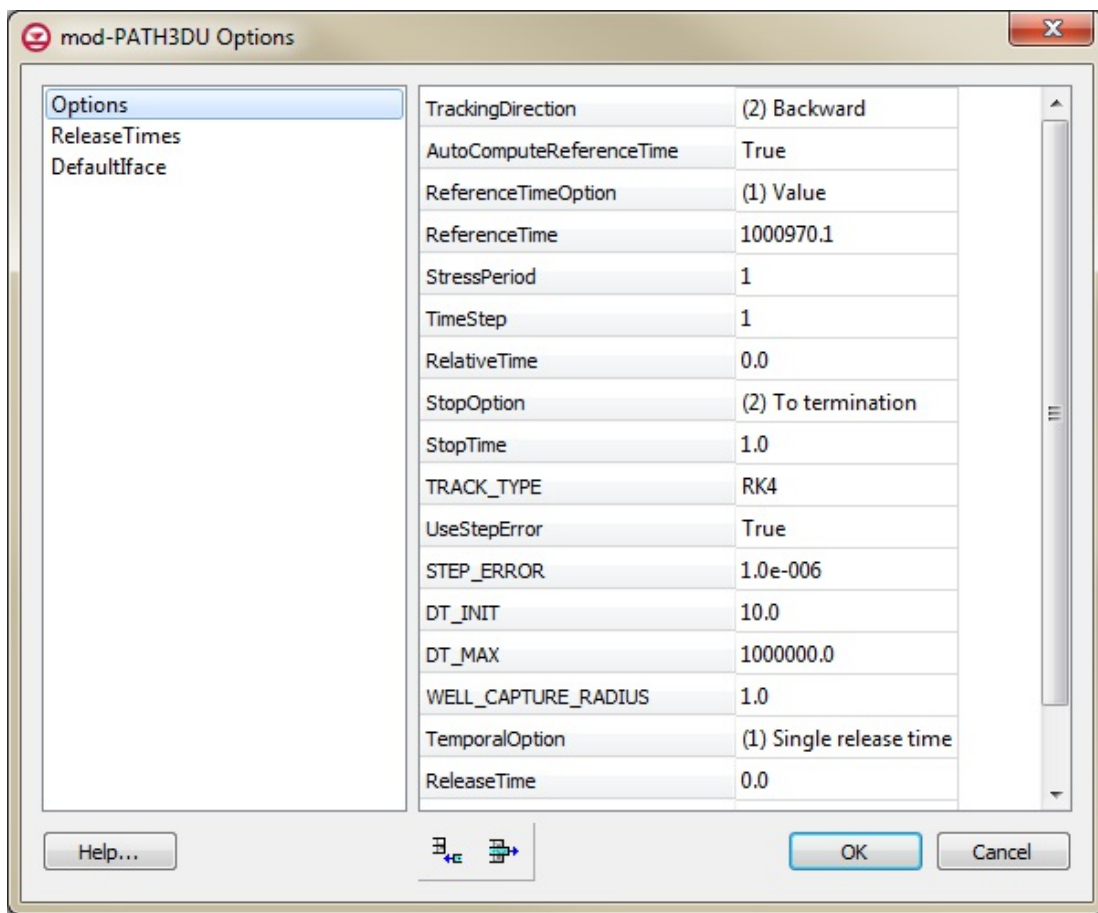

The Mod-PATH3DU Options dialog.

The variables in the *mod-PATH3DU Options* dialog are explained in the following table.

mod-PATH3DU Options

Variable	Options/Values	Description
TrackingDirection	1 - Forward tracking, 2 - Backward tracking	A flag indicating the direction of the particle tracking computation.
AutoComputeReferenceTime	False True	Option to let GMS pick the reference time based on the TrackingDirection. If true, ReferenceTimeOption is set to 1 and, for forward tracking, the reference time will be 0.0. For backward tracking, the reference time will be the end time of the model.
ReferenceTimeOption	1 - Specify a value for reference time 2 - Specify stress period, time step and relative time position within the time step to use to compute the reference time	A flag indicating how reference time will be specified. Reference time is the starting time for the particle-tracking with respect to the start of the MODFLOW-USG simulation.
StressPeriod	Stress period	If ReferenceTimeOption = 2
TimeStep	Time step	If ReferenceTimeOption = 2
RelativeTime	Relative time (between 0 and 1)	If ReferenceTimeOption = 2
StopOption	1 - Stop at the end (forward tracking) or beginning (backward tracking) of the MODFLOW-USG simulation 2 - Track until all particles reach their termination points 3 - Specify a value of tracking time at which to stop	A flag indicating how the particle tracking simulation should be terminated.
StopTime	Stop time	If StopOption = 3
TRACK_TYPE	"RK4" (Default) "EULER"	Tracking method. Default is "RK4"
UseStepError		STEP_ERROR is set to 1e6 if not being used.
STEP_ERROR		Adaptive stepsize error term, ϵ , in equation 2-17. Default is 1.00E-06. Larger values will result in a faster runtime with, potentially, less accurate paths. To turn-off the adaptive step size option make STEPERROR large (1.00E+06).
DT_INIT		Initial step size. Default is 10.
DT_MAX		Maximum step size. Default is 1.00E+06
WELL_CAPTURE_RADIUS		When FORWARD tracking using the adaptive time step option (STEP_ERROR < 1), WELL_CAPTURE_RADIUS is the radial distance from the well, within which, a particle is considered captured.
TemporalOption	1 - A single ReleaseTime will be used for all particles 2 - Particles will be released ReleaseEventCount times every ReleasePeriodLength 3 - Particles will be released ReleaseEventCount times at the specified ReleaseTimes	A flag indicating whether a single or multiple release events will be used for particles.
ReleaseTime	Greater than 0.0	Release time of particles relative to mod-PATH3DU tracking time.
ReleaseEventCount	Greater than 0	If TemporalOption = 2 or 3. The number of release events.
ReleasePeriodLength	Greater than 0.0	If TemporalOption = 2. The time interval between particle release events.

Adding Starting Locations

To add starting locations to the simulation, there are three methods:

1. Select cells and use the **Create mod-PATH3DU Particles** command from the right-click menu.
2. Right-click the mod-PATH3DU  simulation and select the **Create Particles at Wells** command.
3. Creating starting locations from another UGrid's points or cells (starting with GMS 10.3).

See [MODPATH Particle Tracking, Generating Particles](#) for more information on these commands.

The GRID2D and WELL2D options are not yet supported for defining starting locations.

Model Checker

Prior to running mod-PATH3DU, it is a good idea to run the Model Checker by right-clicking the mod-PATH3DU simulation and selecting the **Check Simulation** command. The Model Checker looks for obvious problems in model setup and reports them as warnings or errors.

Saving and Running the Model

Unlike MODPATH, mod-PATH3DU does not have an option to run automatically in GMS when changes are made to the model. The user must save and run the model manually.

mod-PATH3DU cannot read the MODFLOW-USG files that use the [GMS modified input format](#). The user must use the *Save native text copy* option for MODFLOW-USG, and a solution must be generated for the native text copy of the MODFLOW-USG model. This can be done by using the *MODFLOW | Advanced | Run MODFLOW Dialog* command.

Running MODFLOW-USG normally will not generate a solution for the native text copy.

When the project is saved, the mod-PATH3DU input files are saved with the MODFLOW-USG native text input files.

To run mod-PATH3DU, right-click the mod-PATH3DU model icon in the Project Explorer and select the **Run mod-PATH3DU** command. In GMS 10.2, the *Run Model* dialog appears and let's the user choose the mod-PATH3DU model executable to run and the *.mpsim file to pass to it. mod-PATH3DU runs in a console window—there is no model wrapper dialog for mod-PATH3DU like with other models. Starting with GMS 10.3, a model wrapper dialog is used to display the model progress and when the model finishes, the solution will be read automatically if the "Read solution on exit" option is checked.

mod-PATH3DU version 1.1.0 uses a modified [grid specification file \(gsf\)](#). A utility called writep3dgsf.exe creates the modified gsf given the standard gsf and is included with mod-PATH3DU version 1.1.0. GMS runs this utility automatically just before mod-PATH3DU is run from GMS and the new file is given a .gsf2 extension.

Reading the Solution

After running mod-PATH3DU, a solution is generated consisting of a pathline (*.ptl) file and a listing file (*.mplist). Starting with GMS 10.3, the model wrapper will import the solution automatically. In GMS 10.2, import the solution by right-clicking the mod-PATH3DU model in the Project Explorer and selecting the **Read Solution** command. The user is prompted to open a *.ptl file. Upon doing so, the solution is displayed in the Project Explorer and the pathlines are drawn on the UGrid.

Display Options

The display options for mod-PATH3DU are identical to those for MODPATH. See [MODPATH Display Options](#). Capture zones and [zone codes](#) also work identically for mod-PATH3DU.

Exporting Data

The mod-PATH3DU model data can be exported in a few different ways for processing in other programs if desired. The **Export** command can be used to export a shapefile of the pathline solution. Three different types of shapefiles can be exported: a point shapefile containing pathline points, a line shapefile containing the pathlines, and a polygon shapefile

containing capture zone polygons. A tab delimited file containing the pathline points can also be exported.

Links

- [mod-PATH3DU Commands](#)

Mod-PATH3DU Commands

Most of the *mod-PATH3DU* menu commands are found by right-clicking on the mod-PATH3DU item in the [Project Explorer](#). There is no *mod-PATH3DU* menu in the main menu bar.

New mod-PATH3DU...

This command is found by right-clicking on a ugrid. It results in the creation of a new mod-PATH3DU simulation. Multiple simulations can exist at the same time.

Run mod-PATH3DU...

Launches the mod-PATH3DU executable with the selected model as input. The project has to have been saved previously so that the mod-PATH3DU input files are ready to run.

Check Simulation...

Opens the mod-PATH3DU Model Checker which can be used to detect obvious errors in the model setup.

Options...

Opens the [mod-PATH3DU Options](#) dialog which lists the options available for modifying the model.

Porosity...

Opens the array editor dialog that allows specifying porosity for every cell in the model. This porosity array is the same as the one used by [MODPATH](#) and is accessible from the MODPATH menus as well as from the [MODFLOW Global Options/Basic Package](#) dialog.

Tracking Algorithm...

mod-PATH3DU allows specifying the tracking algorithm to be used on a cell-by-cell basis. This data is saved as an array in the MPBAS file. This command allows editing this array. A value of 1 indicates the Pollock Method, a value of 2 indicates the SSP&A method, and a value of 3 indicates the Waterloo method (recommended).

Create Particles At Wells...

Creates particles in cells that contain MODFLOW well boundary conditions. A circular

ring of particles is created around the center of the cell.

Create Particles from UGrid...

Creates particles from the points or cells of a user specified UGrid.

View Pathline Report...

Opens a dialog showing a spreadsheet containing information on all pathlines in the selected simulation.

Export...

Allows saving model data in various formats: the native model files, the pathlines to a line shapefile, the pathline points to a point shapefile, the capture zone polygons to a polygon shapefile, the pathline data to a tab delimited file.

Related Topics

- [mod-PATH3DU](#)

6.7. MT3DMS

MT3DMS

MT3DMS (Modular Transport, 3-Dimensional, Multi-Species model) is a modular three-dimensional transport model for the simulation of advection, dispersion, and chemical reactions of dissolved constituents in groundwater systems (Zheng, 1990). MT3DMS uses a modular structure similar to the structure utilized by MODFLOW. MT3DMS is used in conjunction with [MODFLOW](#) in a two step flow and transport simulation. Heads and cell-by-cell flux terms are computed by MODFLOW during the flow simulation and are written to a specially formatted HFF file (referenced by the LMT file). Note: MODFLOW will produce these files even if transport is turned off. These files are then read by MT3DMS and utilized as the flow field for the transport portion of the simulation.

Background

MT3DMS is a newer version of the old MT3D model that was distributed with earlier versions of GMS. GMS 8.0 and later now run MT3DMS version 5.3 (built in Feb 2010). MT3DMS differs from MT3D in that it allows for multi-species transport, supports additional solvers, and allows for cell-by-cell input of all model parameters.

The [RT3D](#), [SEAM3D](#) and [PHT3D](#) models are special versions of MT3DMS that have been customized to simulate reactive transport problems. The interfaces to MT3DMS, RT3D, SEAM3D and PHT3D are all contained in the *MT3DMS* menu. [MT3D-USGS](#) is another version of MT3D released in 2016 that includes the functionality of MT3DMS plus additional capabilities and packages.

A complete description of MT3DMS is beyond the scope of this reference manual. It is assumed that the reader has a basic knowledge of MT3DMS and is familiar with the MT3DMS [original](#) and [supplementary](#) documentation (Zheng, 1990). Only the details of the GMS graphical interface to MT3DMS are described in these pages.

MT3DMS in GMS

A special version of MT3DMS is distributed with GMS, and the model is included with all [paid editions](#) of GMS.

This version of MT3DMS has been modified to output [GMS dataset files](#). GMS supports MT3DMS as a pre- and post-processor where the input data for MT3DMS is generated by GMS and saved to a set of files. These files are then read by MT3DMS when MT3DMS is executed from the [GMS menu](#). The output super file (*.mts) generated from MT3DMS is then imported to GMS for [post-processing](#) and viewing.

MT3DMS Run Options

MT3DMS requires using solution files generated from a MODFLOW model run. An option is provided to use MODFLOW solution files completed from previous model runs using the *Run Options* dialog.

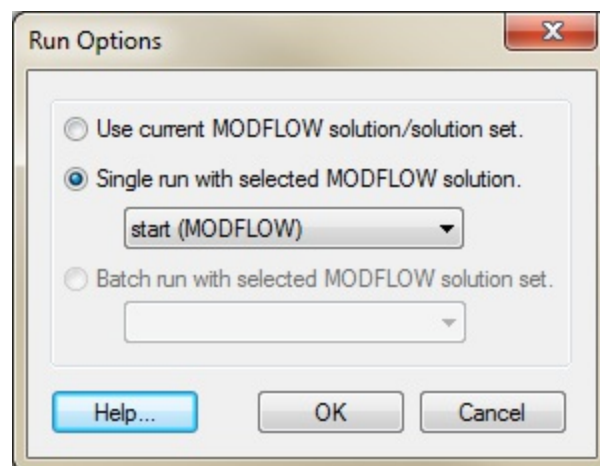

The Run Options dialog

Supported MODFLOW Packages

MT3DMS v5.3 supports the following MODFLOW packages that are also supported in GMS: BAS6, BCF, LPF, HUF, HFB, CHD, WEL, DRN, RIV, GHB, RCH, EVT, STR, and LAK.

MT3DMS Files

Here are tables of some of the available input and output files for MT3DMS.

- For more information on these files see the [MT3DMS manual](#).

Input Files

Name	Description
MTS	MT3DMS Super File
BTN	Basic Transport Package File
ADV	Advection Package File
DSP	Dispersion Package File
SSM	Sink and Source Mixing Package File
RCT	Chemical Reactions Package File
GCG	Generalized Conjugate Gradient Solver Package File
TOB	Transport Observation Package File
PHC	PHT3D-PHREEQC Interface Package File
HSS	Hydrocarbon Spill Source Time-Varying Package File

Output Files

Name	Description
OUT	Model Output Text File
CNF	Model Spatial Discretization Configuration File
UCN	Unformatted Concentration (Dissolved Phase) File
UCN	Unformatted Concentration (Sorbed/Immobile Phase) File
OBS	Concentration Observation File
MAS	Mass Budget Summary File
OCN	Output Concentration File
MTR	Unformatted Concentration (Sorbed/Immobile Phase) File
PST	Binary Post-Processing File
MAS	Mass Budget Summary File

MT3DMS Links

- [MT3DMS Packages](#)
- [Building an MT3DMS Simulation](#)
- [Saving an MT3DMS Simulation](#)
- [Importing an MT3DMS Simulation](#)

See also

- [Building MODFLOW Model](#)
- [Statistical Analysis of Stochastic MODFLOW/MT3DMS solutions](#)

MT3DMS Packages

MT3DMS is divided into a series of components called "packages." Each package performs a specific task. Some of the packages are always required for a simulation, and some are optional. The input for each package is contained in a separate text file. The [MT3DMS packages](#) supported in the GMS interface are listed in the following table:

Package Name	Abbrev.	Description	Always Req'd?
Basic Transport Package	BTN	Handles basic tasks that are required by the entire transport model. Among these tasks are definition of the problem, specification of the boundary and initial conditions, determination of the step size, preparation of mass balance information, and printout of the simulation results.	YES
Advection	ADV	Solves the concentration change due to advection with one of the three mixed Eulerian-Lagrangian schemes included in the package: MOC, MMOC, or HMOC	NO
Dispersion	DSP	Solves the concentration change due to dispersion with the explicit finite difference method.	NO
Sink & Source Mixing	SSM	Solves the concentration change due to fluid sink/source mixing with the explicit finite difference method. Sink/source terms may include wells, drains, rivers, recharge, and evapotranspiration. The constant-head boundary and general-head-dependent boundary are also handled as sink/source terms in the transport model.	NO
Chemical Reactions	RCT	Solves the concentration change due to chemical reactions. Currently, the chemical reactions include linear or nonlinear sorption isotherms and first-order irreversible rate reactions (radioactive decay or biodegradation).	NO
Generalized Conjugate Gradient Solver	GCG	This package can be used to implicitly solve the dispersion, source/sink, and reaction terms of the transport equation.	NO
Transport Observation	TOB	Outputs concentration at observation points and mass fluxes at groups of source/sink boundary conditions.	NO
PHT3D-PHREEQC Interface	PHC	Used by PHT3D to define options for species related to PHREEQC geochemical reactions.	NO

Examples of MT3DMS package dialogs

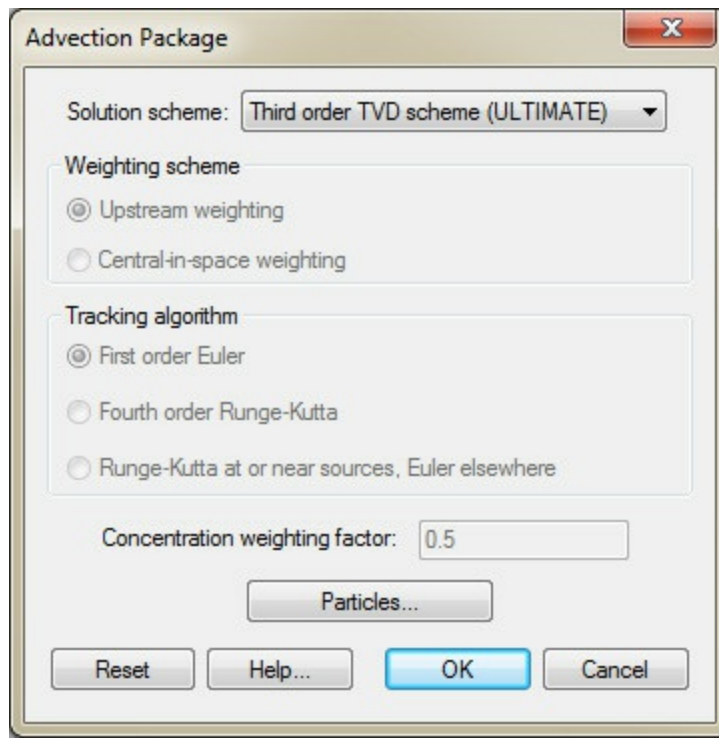

The MT3DMS Advection Package dialog.

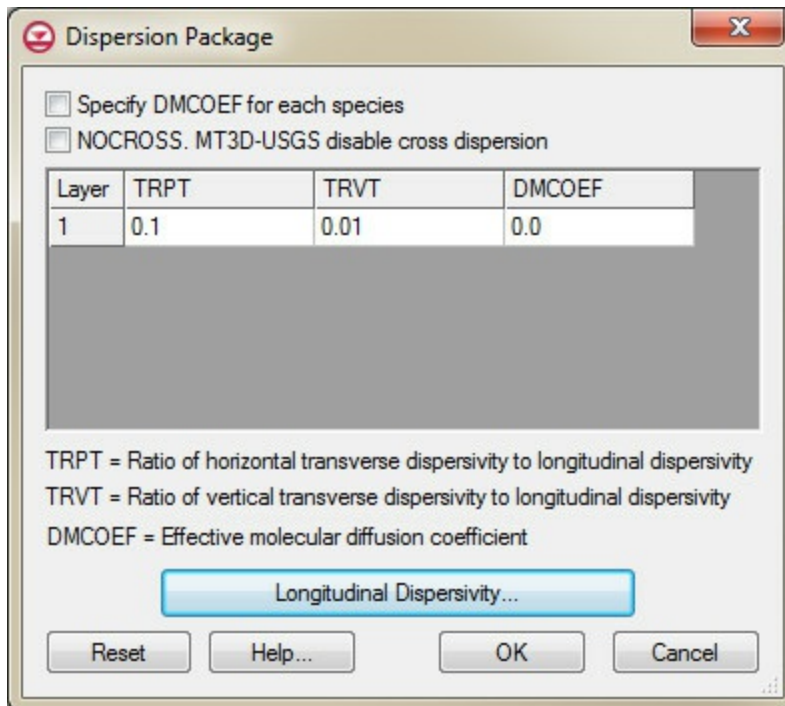

The MT3DMS Dispersion Package dialog.

MT3DMS Source/Sink Mixing Package

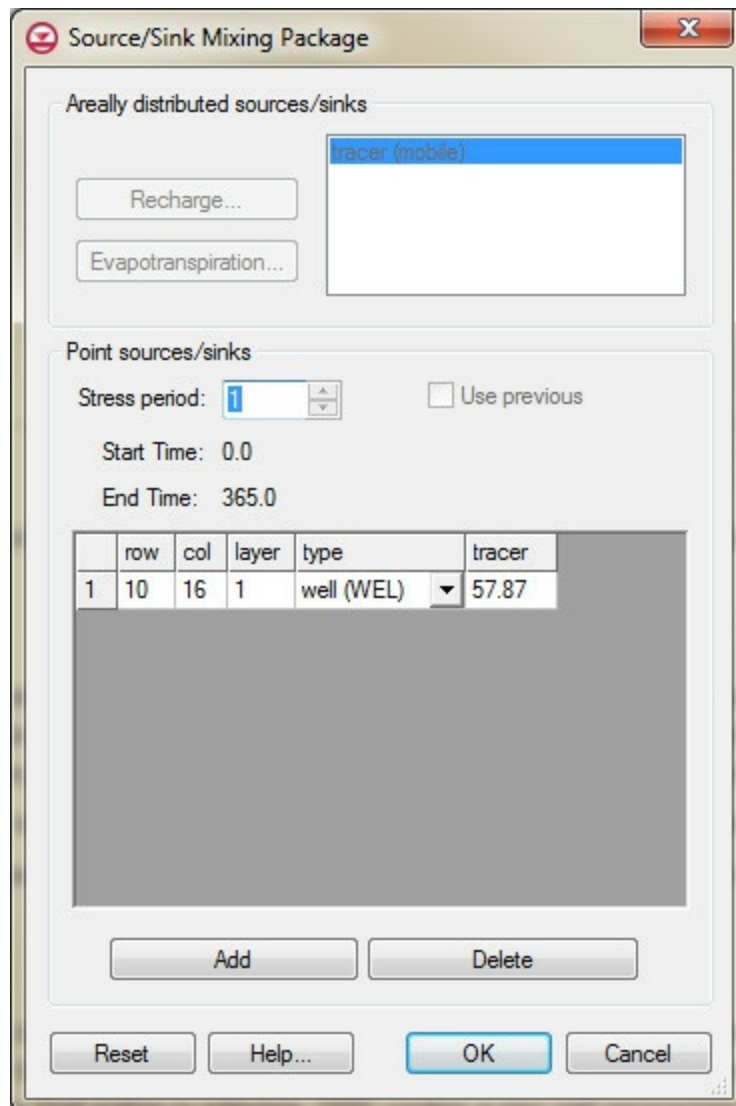

The MT3DMS Source/Sink Mixing Package dialog.

The *Source/Sink Mixing Package* dialog is used to assign concentrations to [point sources/sinks](#) (wells, river/streams, specified head, general head) and [areal sources/sinks](#) (recharge, evapotranspiration). In most cases, the concentration is assigned to the incoming water when the sources/sinks are acting in the source mode, i.e., contributing water to the system. In sink mode, the concentration of the outgoing water is equal to the concentration of groundwater in the aquifer and the concentrations assigned to the sources/sinks have no effect because the water and species is being removed by the

negative flow out of the ground. The only exception is evapotranspiration. Even though [evapotranspiration](#) always acts in sink mode, a concentration can be specified. Generally, the assigned concentration is zero which only allows pure water to leave the aquifer.

Source/Sink Mixing Package dialog

The information below describes the dialog.

Maximum number of Sources/Sinks in Flow Model

MT3DMS needs to know the maximum number of sources/sinks in the flow model. This number is simply the total number of cells in the MODFLOW model that have a source or sink defined at them. This number is computed automatically.

Point sources/sinks spreadsheet

Values for the concentration as well as the type of source or sink and the location of each of the point source/sink cells are displayed and edited in the spreadsheet. Since the concentration data are time dependent, one value is defined for the concentration at each [stress period](#). Concentration values are displayed in the spreadsheet for the current stress period only. The current stress period is displayed above the spreadsheet and can be changed. If the concentration values for a previous stress period are the same as those used for the current stress period, the *Use previous* option may be used. When the *Use previous* option is selected, the fields in the spreadsheet cannot be edited.

A column is provided for each of the species concentrations. Changing the source/sink type for one stress period at a cell will automatically change the type for the remainder of the stress periods at the same cell.

Point sources/sinks can be added and removed from the list by selecting the **Add** and **Delete** buttons. However, when adding new point source/sink, it is usually more convenient to select the 3D grid cells and use the [MT3DMS | Point Sources/Sinks](#) menu command.

Initializing Point Source Sinks from MODFLOW

An option is included in the *Source/Sink Mixing Package* dialog to initialize the point

sources/sinks to be used in the MT3DMS simulation directly from data that have already been defined in a MODFLOW simulation. If a MODFLOW simulation is currently in memory, the buttons in the *Initialize point sources/sinks from MODFLOW* dialog can be used. Each button is labeled with a different source/sink type, corresponding to the MODFLOW point sources or sinks. Selecting one of the buttons automatically adds to the list of point sources/sinks. For example, if the **Well** button is selected, GMS creates a new well source/sink for each cell where a well is defined in the MODFLOW simulation currently in memory. The initial concentration of each of the new well sources/sinks is zero. In order to utilize the source/sink initialization buttons, the following conditions must be met:

1. The MODFLOW package corresponding to the source/sink type to be initialized must have been selected in the *MODFLOW Packages* dialog.
2. Point sources or sinks of the type to be initialized must have been defined in MODFLOW.

Specified Concentration Boundary Conditions

When entering the concentrations for a specified concentration cell, it is sometimes necessary to specify the concentrations of some of the species but allow the concentrations for the remaining species to vary. This can be accomplished by specifying a negative concentration for the species that are to vary.

Areal Sources/Sinks

Recharge and evapotranspiration are known as areally distributed sources and sinks. This is because a value for concentration must be entered for each species for every vertical column of cells in the finite difference grid. This essentially means that a two dimensional array of concentration values must be defined for each species for both recharge and evapotranspiration, depending upon which options are utilized. The buttons labeled **Recharge** and **Evapotranspiration** bring up the *Areal Source/Sink Array* dialog.

Reset

The **Reset** button deletes all of the data currently defined in the *Source/Sink Mixing package* and restores the package parameters to the default values.

Conceptual Model Input

In some cases, the simplest way to define both point and areal sources/sinks is with an MT3DMS [conceptual model](#) in the [Map module](#). Concentrations can be assigned directly to [points, arcs, and polygons](#); points representing point sources/sinks and polygons representing recharge and evapotranspiration zones. These concentrations are copied directly to the appropriate cells/arrays in the *Source/Sink Mixing package* when the conceptual model is converted to the numerical model with the [Feature Objects | Map → MT3DMS](#) command.

Chemical Reaction Package

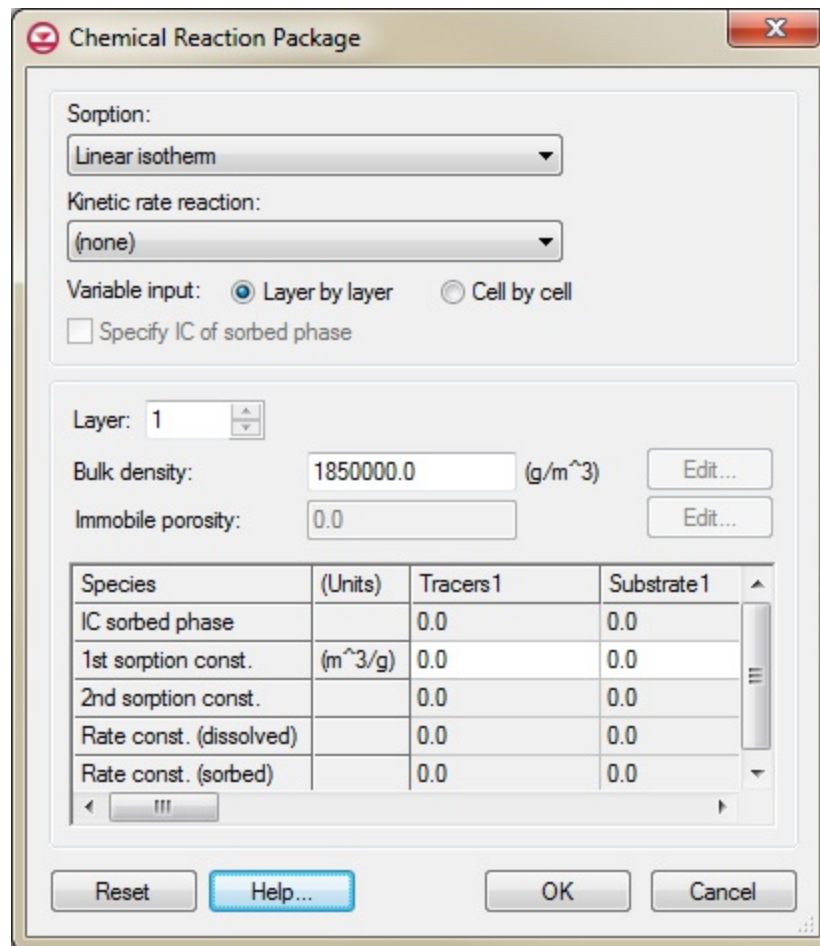

The Chemical Reaction Package dialog

The *Chemical Reaction Package* dialog is used to solve the concentration change due to chemical reactions. Chemical reactions can be defined for the MT3DMS, MT3D-USGS, PHT3D, and SEAM3D models. The dialog is reached through the model menu using the "[Chemical Reaction Package](#)" command which is only available once the package has been activated in the "[Packages](#)" dialog and species have been defined. The chemical reactions include linear or nonlinear sorption isotherms and first-order irreversible rate reactions (radioactive decay or biodegradation).

The dialog has the following options:

- *Sorption* – Select one of the following methods:

- "(none)"
- "Linear isotherm"
- "Freundlich isotherm"
- "Langmuir isotherm"
- "First-order kinetic sorption (non-equilibrium)"
- "Dual-domain mass transfer (without sorption)"
- "Dual-domain mass transfer (with sorption)"
- ***Kinetic rate reaction*** – Has the following options:
 - "(none)"
 - "First-order irreversible kinetic reaction"
 - "Zero-order reaction (decay or production)"
- ***Variable input***
 - *Layer by layer*
 - *Cell by cell*
- ***Specify IC of sorbed phase***
- ***Layer*** – Specifies layer to apply chemical reaction.
- ***Bulk density***
- ***Immobile porosity***

ICBUND Array

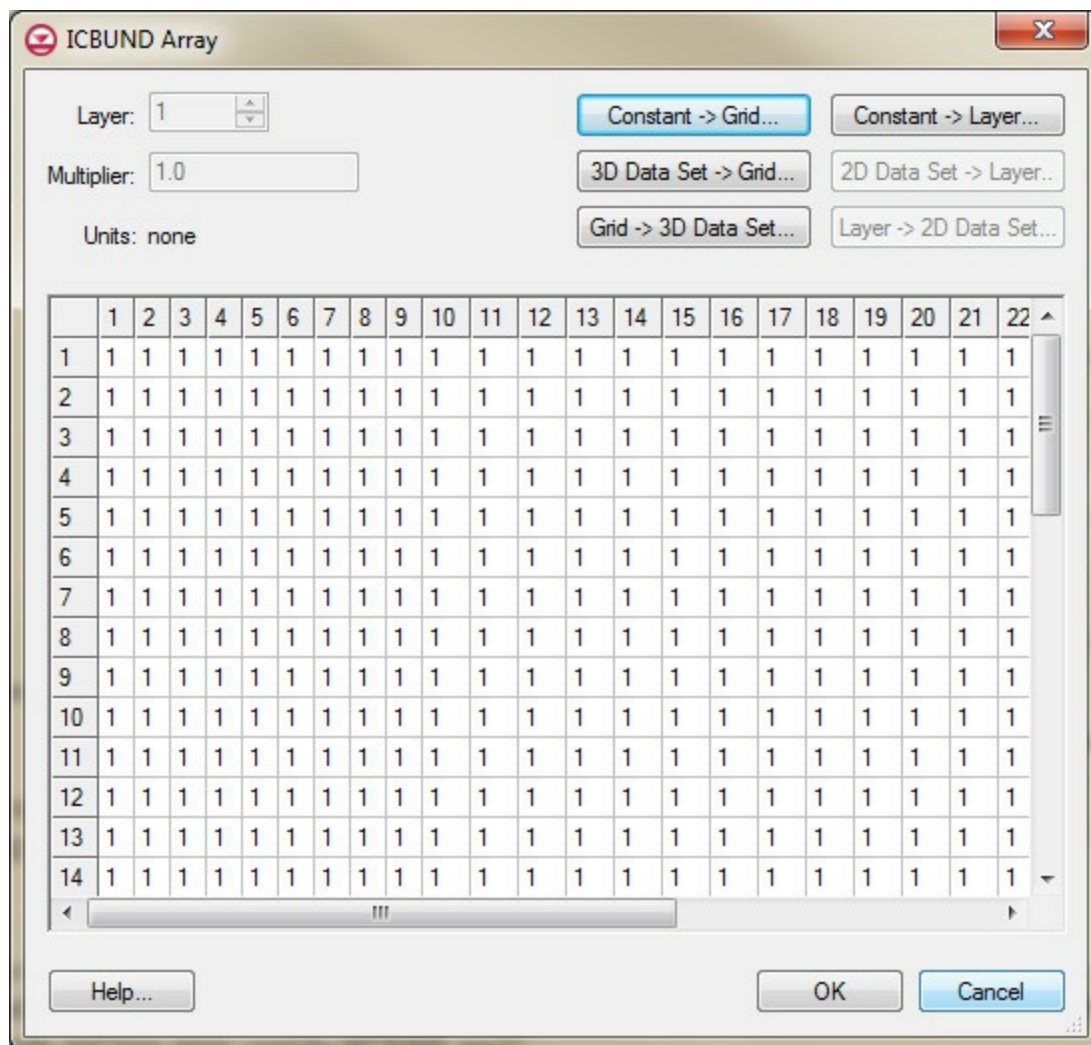

The ICBUND Array dialog.

The **ICBUND** button in the [Basic Transport Package dialog](#) is used to enter the values of the ICBUND array. The [MODFLOW array editor](#) is used to edit the ICBUND array.

Values

The ICBUND array contains a value for each cell in the grid defining the type of the cell as either constant concentration, inactive, or variable concentration.

Constant Concentration

A negative ICBUND value indicates that the cell has a constant concentration. The value of the constant concentration is defined in the starting concentration array described below.

Inactive

An ICBUND value of zero indicates that the cell is inactive.

Variable Concentration

A positive ICBUND value indicates that the cell has a variable concentration (i.e., the concentration will be computed as part of the simulation).

Initializing the ICBUND Array

The [IBOUND array used by MODFLOW](#) is similar (but not identical) to the ICBUND array. When a new MT3DMS simulation is initialized, the MODFLOW IBOUND array is used to initialize the values of the ICBUND array. Each cell which is designated as inactive in the IBOUND array is designated as inactive in the ICBUND array. Each cell which is designated as active (variable head) in the IBOUND array is designated as active (variable concentration) in the ICBUND array. Each cell that is designated as constant head in the IBOUND array is NOT designated as constant concentration in the ICBUND array. Rather, constant head cells are designated as active (variable concentration) in the ICBUND array.

Cell Attributes Command

In addition to directly editing the ICBUND array, another method for editing the ICBUND array is to select a set of cells and use the **Cell Properties** command in the *MT3DMS* menu.

Activate Cells in Coverage Command

If the **Activate Cells in Coverage** command in the [Map module](#) is used to change the active/inactive status of the cells, both the IBOUND and ICBUND arrays are updated accordingly.

Flow vs. Transport Inactive Zones

Since the computational domain of the transport simulation does not necessarily have to match the domain of the flow simulation, the active/inactive zones of the ICBUND array may differ from the active/inactive zones of the IBOUND array. In some cases, the active zone for a transport simulation is only a subset of the active zone of the flow simulation. Care should be taken, however, to ensure that any cells defined as inactive in the flow simulation are not defined as active in the transport simulation.

IBOUND vs. ICBUND Display

If a cell is designated as inactive, it is hidden when the grid is displayed, unless the *Inactive cells* option is selected in the *3D Grid Display Options* dialog, in which case the inactive cells are displayed, but in a different color. If neither MODFLOW nor MT3DMS is in memory, the default 3D grid active/inactive flags are used to control the display of the grid. If MODFLOW is in memory, the active/inactive status of the cells as defined by the IBOUND array is used to display the grid. If both MODFLOW and MT3DMS are in memory, the ICBUND array takes precedence and is used to display the grid.

MT3DMS Point Sources/Sinks BC

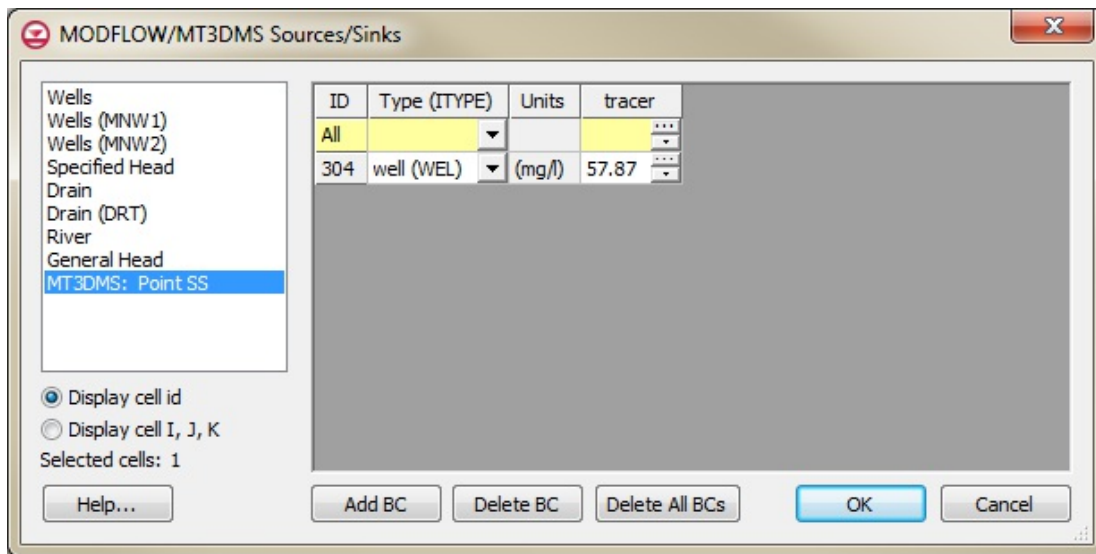

The MODFLOW/MT3DMS Source/Sinks dialog showing point options for MT3DMS

The [Source/Sink Mixing Package](#) dialog can be used to edit both point and areal sources/sinks using a spreadsheet. In many cases, it is more convenient to view and edit source sink concentrations on a cell-by-cell basis. Two commands are provided to facilitate this type of editing: the **Point Sources/Sinks** command and the **Areal Sources/Sinks** command.

Point Sources/Sinks

The **Point Sources/Sinks** command is used to assign and edit the concentrations at point sources and sinks. Before selecting the **Point Sources/Sinks** command, a set of cells should be selected using the cell selection tools. Once the command is selected, the *MT3DMS Point Source/Sink* dialog appears.

A point source/sink concentration for each species is assigned to the selected cells by selecting the toggle corresponding to the type of source/sink. The concentration at the cells can be specified as either constant or transient. If a constant value is specified, this number

will be used for all stress periods. If the *Variable* option is used, clicking on the window brings up the *XY Series Editor*. The *XY Series Editor* is used to assign a concentration value for each stress period.

Multiple Sources/Sinks per Cell

In many cases, multiple point sources/sinks, each having a different type, can be assigned to an individual cell. In this case, the toggle for each type should be selected and the concentration specified. It is also possible for multiple sources/sinks of the same type to be assigned to a single cell. However, **MT3DMS** only allows one concentration to be assigned to each type for a single cell. In such cases, the specified concentration for that type applies to all sources/sinks of that type within the cell.

Fixing Concentrations for Selected Species

When entering the concentrations for a specified concentration cell, it is sometimes necessary to specify the concentrations of some of the species but allow the concentrations for the remaining species to vary. This can be accomplished by specifying a negative concentration for the species that are to vary.

Areal Sources/Sinks

The **Areal Sources/Sinks** command is used to edit the concentrations assigned to recharge and evapotranspiration fluxes. Before selecting the **Areal Sources/Sinks** command, a set of cells should be selected using the cell selection tools. The concentration fluxes due to **recharge** and **evapotranspiration** are applied to vertical columns rather than to individual cells. Therefore, to edit the value for a vertical column, any cell in the column can be selected. Once the **Areal Sources/Sinks** command is selected, the *MT3DMS Areal Sources/Sinks* dialog appears.

The areal source/sink concentration values at the selected cells can be edited by highlighting a species and either selecting a constant value for all stress periods, or by defining a set of values.

See also

- [Cell Attributes](#)

Building an MT3DMS Simulation

Setting up an MT3DMS simulation involves taking a pre-defined MODFLOW simulation and defining some additional properties such as porosity, assigning concentrations to [sources and sinks](#), and choosing some general simulation options. MODFLOW automatically generates a head and flow file (*.hff) containing information on computed heads and fluxes. This file is used as part of the input to the transport model when MT3DMS is launched. MT3DMS uses the top and bottom grid elevation specified in the [Global Options/Basic Package dialog](#). A MODFLOW model must exist in the GMS project prior to creating an MT3DMS simulation.

Two basic approaches are provided in GMS for defining these data: using the [3D Grid module](#) or using the [Map module](#).

Using the 3D Grid Module

Although it is not always the most efficient approach, an MT3DMS simulation can be completely defined using only the tools in the 3D Grid module. With this approach, the material properties and concentrations at sources/sinks [are assigned directly to the cells](#).

Using the Map Module (MT3DMS Conceptual Model)

For sites with complicated boundary conditions and sources/sinks, the preferred method for setting up an MT3DMS simulation is to use the [feature object tools](#) in the [Map module](#) to define an MT3DMS conceptual model of a site being studied.

In order to use the conceptual model approach to build a MT3DMS model, the same conceptual model must be used for both the MODFLOW flow model and the MT3DMS transport model. This ensures that there is a proper linkage between the sources/sinks in the conceptual model and the sources/sinks in the grid model.

The conceptual model is a high-level description of the site describing sources/sinks, the boundary of the domain to be modeled, recharge and evapotranspiration zones, and material zones within each of the layers. In addition to the parameters required by

MODFLOW, many of the parameters required by MT3DMS such as concentrations at sources/sinks and layer data, including porosity and dispersion coefficients, can be assigned directly to the feature objects.

The following steps are used in setting up a conceptual model and converting the conceptual model to a numerical model:

1. Construct a [MODFLOW conceptual model](#), [create a grid](#), and [convert the conceptual model data](#) to the MODFLOW data defined at the grid cells.
2. Run the MODFLOW simulation to save the MT3DMS head and flow file.
3. Return to the [Map module](#). Edit the properties of the conceptual model to include transport. Assign concentrations to the sources/sinks in the conceptual model where necessary. Also define [polygonal zones](#) describing layer data including porosity, longitudinal dispersivity, sorption constants, rate constants, and bulk density.
4. Select the *Feature Objects* | **Map** → **MT3DMS** command to automatically assign the MT3DMS data to the appropriate cells in the grid.

Saving an MT3DMS Simulation

Once an MT3DMS simulation has been created and checked for potential problems with the [Model Checker](#), the final step is to save the simulation to disk and run MT3DMS. MT3DMS simulations are saved using the **Save** and **Save As** commands in the *File* menu.

Selecting the **Save** command saves the GMS project including the model simulation. By default the model simulation will be saved to the same location as the GMS project. However, in the *Save* dialog the path for the model simulation can be specified to be different from the project file if the "Match model names with project name" option is unchecked. This is done with the **Browse** buttons next to each model.

An MT3DMS simulation is saved to a set of input files. The MT3DMS super file is a special type of file which is used to organize the set of files used in a simulation. The names of all of the input and output files associated with a simulation are saved in the super file. When MT3DMS is launched, the name of the super file is automatically passed to the MT3DMS executable.

When an MT3DMS simulation is saved, the names of the other MT3DMS input files are automatically patterned after the name of the super file. For example, if the super file is named `sampmod.mts`, the other files are named `sampmod.btn`, `sampmod.ssm`, etc.

This content also applies to [RT3D](#), [SEAM3D](#) and [PHT3D](#).

Importing an MT3DMS Simulation

It is often necessary to import an MT3DMS simulation that was not generated by GMS. Since GMS uses the standard MT3DMS file format, this is not a problem in most cases. However, there are a few steps and precautions that should be taken.

File Formats

GMS uses the standard MT3DMS file formats described in the MT3DMS documentation (Zheng, 1998). The files being imported must match these formats exactly. If the files were generated for a version of MT3DMS that uses a different set of file formats, the files will need to be edited before they can be successfully imported to GMS.

CON File

The source code of MT3DMS was changed to create a *.con file instead of the default *.ucn file. GMS can read either the *.con or *.ucn file. The *.con file is written in the [GMS binary dataset format](#).

Importing Super Files

GMS uses an MT3DMS super file to organize the files used by an MT3DMS simulation. This file is not a standard MT3DMS file. One approach to importing an externally defined simulation is to create an MT3DMS super file containing the names of the files used in the simulation using a text editor.

MT3DMS Display Options

The properties of all MT3DMS data that GMS displays on the screen can be controlled through the MT3DMS tab of the *Display Options* dialog. This dialog is opened by right-clicking on the "3D Grid Data" entry in the [Project Explorer](#) and selecting the **Display Options** command. It can also be accessed from the *Display* menu, the *MT3DMS* menu, or the **Display Options** macro. The following table describes the display options available for the 3D Grid module.

Display Option	Description
Point Sources/Sinks, NAPL Point Sources/Sinks, Constant concentration	The three items at the top of the dialog represent display options for the constant concentration cells and the point sources/sinks. If the check box just to the left of one of these is selected, a symbol is displayed at the center of each cell where that object has been defined. The symbol for each object is displayed in a window to the left of the check box. The symbol can be changed by clicking on the button. This brings up the <i>Symbol Editor</i> dialog. The <i>Symbol Editor</i> contains a list of available symbols and can be used to edit the size and color of the symbol.
Display symbol legend	If the <i>Symbol legend</i> option is selected, a legend showing each of the symbols associated with sources/sinks and constant concentration cells is displayed in the lower right corner of the GMS window.
Check All	By clicking this button, all of the display options are turned on.
Check None	By clicking this button, all of the display options are turned off.

Calculate Mass

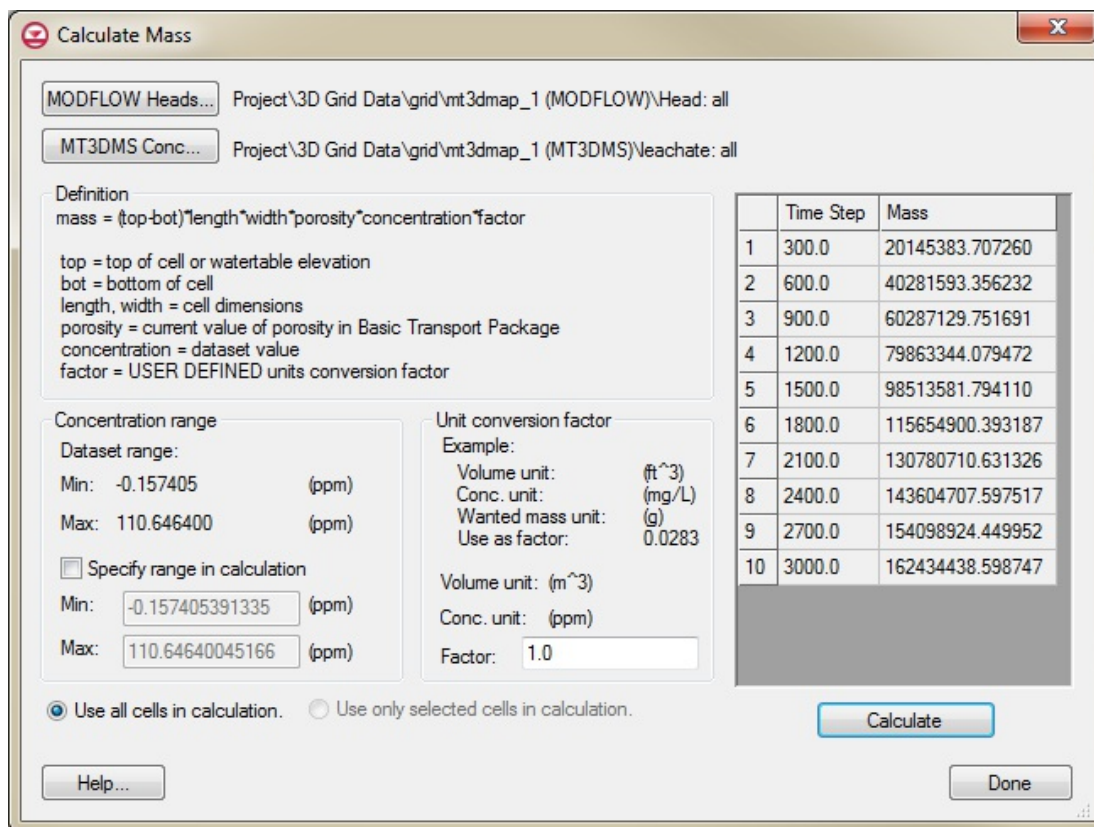

Example of the MT3DMS Calculate Mass dialog.

The MT3DMS *Calculate Mass* dialog allows the calculation of the mass of a contaminant in the entire model domain or in the selected cells. The dialog is reached through the **Calculate Mass** command in either *MT3DMS* menu or the *PHT3D* menu. The appropriate datasets must already exist in the project before this dialog can be accessed.

At the top of the dialog, the **MODFLOW Heads** and **MT3DMS Conc...** buttons bring up a *Select Dataset* dialog where the head and concentration datasets can be selected. All time steps in the datasets can be used or specific time steps can be selected. Selecting the **Calculate** button will populate the table on the right with the mass at each time step.

Definition

Explains the formula that is used to calculate the mass. Basically, the volume of water in each cell is calculated and then multiplied by the concentration computed by MT3DMS. A conversion factor must be supplied so that the calculated mass will be computed in the correct units.

Concentration Range

Allows the specification a range over which the mass will be calculated. This is most useful to ignore negative concentrations that result in MT3DMS simulations.

By default, the range of the selected dataset is used. Turning on the *Specify range in calculation* option allows using a specific range inside the dataset by setting the minimum and maximum values.

Conversion Factor

The *Factor* determines which units the resulting mass will be displayed in.

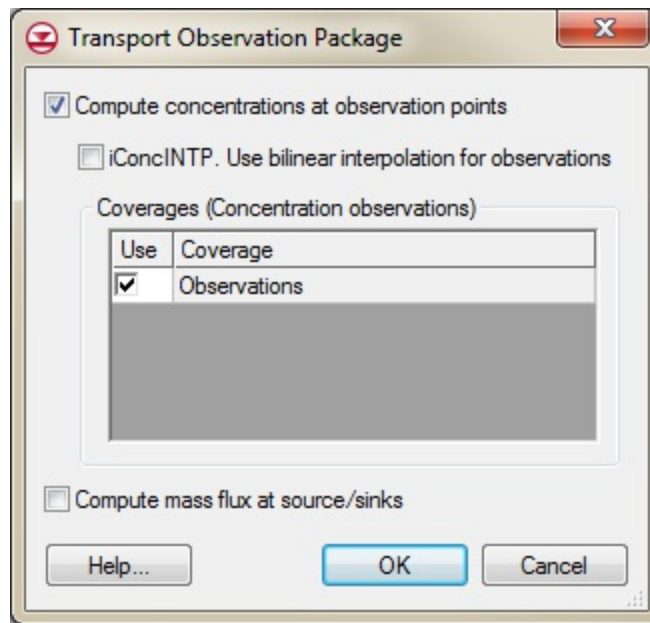

The MT3D Transport Observation Package dialog.

The *Transport Observation Package* (TOB) calculates simulated concentrations associated with observation points and mass flux associated with MODFLOW boundary conditions. The dialog is reached through the **Transport Observation Package** command in the *MT3DMS* or *MT3D-USGS* menus after the package has been selected during the model setup.

The concentration observations may be from observation points. The observations are specified in coverages in the map tools within GMS. Coverages selected in this dialog will be used by the package.

The package can also compute a mass flux associated with a group of MODFLOW boundary conditions. For example, if a contaminant plume migrates to a river this package can compute a mass flux into the river. This is similar to the flow observation groups that are created in MODFLOW models.

MT3DMS Commands

When the MT3DMS model is active, the *MT3DMS* menu becomes active. The menu is also used for the MT3D-USGS, RT3D, SEAM3D, and PHT3D models.

The menu has the following commands:

New Simulation...

Starts a new MT3DMS simulation. This command will delete any existing MT3DMS data running in GMS.

Delete Simulation...

Removes the selected simulation from GMS.

Check Simulation...

Starts the *Model Checker* dialog.

Run Options...

Brings up the *Run Options* dialog.

Run MT3DMS...

Executes the MT3DMS model.

Run SEAM3D...

Executes the SEAM3D model.

Read Solution...

The command will open a MT3DMS solutions file.

Display Options...

Opens the *Display Options* dialog. See [MT3DMS Display Options](#) for more information.

Point Sources/Sinks...

See [MT3DMS Source/Sink Mixing Package](#) for more information.

Areal Sources/Sinks...

Cell Properties...

Brings up the *3D Grid Cell Properties* dialog. See [Cell Properties](#) for more information.

Calculate Mass...

Opens the *Calculate Mass* dialog. To learn more, see [Calculate Mass](#).

Basic Transport Package...

Launches the *Basic Transport Package* dialog. For more information, see [Basic Transport Package Dialog](#).

Advection Package...

Brings up the *Advection Package* dialog. This package solves the concentration change due to advection.

Dispersion Package...

Brings up the *Dispersion Package* dialog. This package solves the concentration change due to dispersion.

Source/Sink Mixing Package...

Opens the *Source/Sink Mixing Package* dialog. To learn more, see [MT3DMS Source/Sink Mixing Package](#).

Chemical Reaction Package...

Starts the [MT3DMS Chemical Reaction Package](#) dialog. Solves the concentration change due to chemical reactions.

Transport Observation Package...

Brings up the *Transport Observation Package* dialog. Outputs concentration at observation points and mass fluxes at groups of source/sink boundary conditions.

GCG Package...

Launches the *GCG Solver* dialog. The Generalized Conjugate Gradient Solver is used to solve the dispersion, source/sink, and reaction terms of the transport equation.

Biodegradation Package...

Opens the [Biodegradation Package](#) dialog.

NAPL Dissolution Package...

Brings up the [NAPL Dissolution Package](#) dialog.

Reductive Dechlorination Package...

Launches the [Reductive Dechlorination Package](#) dialog.

Cometabolism Package...

Opens the [Cometabolism Package](#) dialog.

Related Topics

- MT3DMS

6.8. MT3D-USGS

MT3D-USGS

MT3D-USGS is a version of MT3DMS released in October 2016 that includes the functionality of [MT3DMS](#) plus additional features and packages. MT3D-USGS includes transport modeling capabilities to make use of flow terms calculated by MODFLOW packages previously unsupported by MT3DMS. The model also provides greater flexibility in the simulation of solute transport and reactive solute transport.

A complete description of MT3D-USGS is beyond the scope of this wiki. It is assumed that the reader has a basic knowledge of MT3D-USGS and is familiar with the documentation. Only the details of the GMS graphical interface to MT3D-USGS are described herein.

In GMS, MT3D-USGS uses the same graphical interface available for MT3DMS. Specify a model is to use MT3D-USGS in the [Basic Transport Package dialog](#). This will activate the *MT3D-USGS* menu which is identical to the [MT3DMS](#) menu.

6.9. PEST

PEST

PEST (Parameter ESTimation) is a general purpose parameter estimation utility developed by John Doherty of Watermark Computing. The nonlinear [parameter](#) estimation algorithm used by PEST is uniquely robust and powerful having been developed for use with complex environmental models. The purpose of PEST is to assist in data interpretation, model calibration, and predictive analysis.

GMS provides a custom interface to the PEST utility offering a simple way to set model parameters and a graphical user interface to run the model and visualize the results. The PEST interface in GMS can be used to perform [automated parameter estimation](#) for MODFLOW. The steps involved in setting up a PEST run are described in the [automated parameter estimation](#) topic. The PEST options are edited by selecting the **Parameter Estimation** command in the *MODFLOW* menu and then clicking on the *PEST* tab.

PEST can be added to a [paid edition](#) of GMS, and can be run with parallel processing across one or multiple machines with the Parallel PEST Utility.

PEST version support

The following table shows the version of PEST supported by different versions of GMS. To see the latest released version of PEST visit

<http://www.pesthomepage.org/Downloads.php>.

GMS	PEST
GMS 6.5	PEST 10.0
GMS 7.0	PEST 10.0
GMS 7.1	PEST 12.0
GMS 8.0, 8.1, 8.2	PEST 12.1
GMS 8.3, 9.0	PEST 12.2
GMS 9.1, 9.2	PEST 12.3
GMS 10.0	PEST 13.0
GMS 10.1	PEST 13.5
GMS 10.2	PEST 13.6
GMS 10.3	PEST 14.0

MODFLOW/PEST Parameter Estimation Model Wrapper

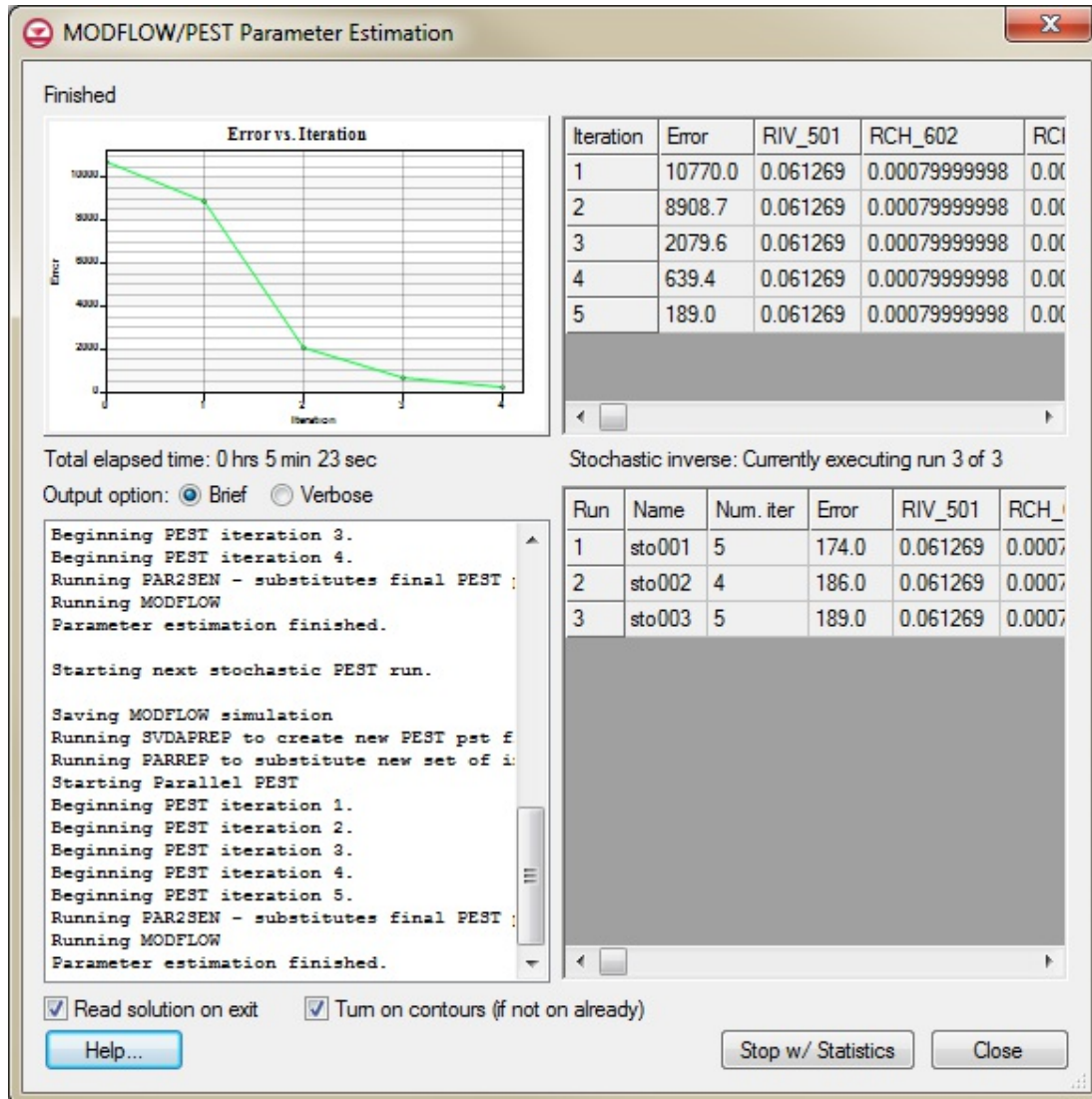

MODFLOW/PEST Parameter Estimation model wrapper dialog

There are four sections of the *MODFLOW/PEST Parameter Estimation* model wrapper dialog

The top left section features a graph that shows the model error vs. PEST iteration. To the right of the graph is a spreadsheet showing the model error and the parameter values for each PEST iteration. Below that, in the bottom right section, is another spreadsheet showing the results for each realization (run) and includes the number of PEST iterations, the model error, and the parameter values. In the bottom left section, a text window shows the output PEST prints to the screen when run from the command line.

PEST Files

Below are tables of all the available input and output files with the PEST

- For more information on these files see page 51 of the MODFLOW PEST online documentation ([\[1\]](#))

Input Files

Name	Description	Required/Conditional
.PST	PEST Main Control File	Required
.PARAM	Parameter Defining File	Required
.TPL	Template Parameter Values to Input File	Required
.INS	Instruction Output Parameter Reading File	Required
.RMF	Parallel Run Management File	Conditional
.HLD	Parameter Manual Hold Values File	Conditional

Output Files

Name	Description
.REC	Run Progress Record File
.CND	Condition Number File
.MTT	Matrix Information File
.SEN	Parameter Sensitivity Record File
.SEO	Composite Observation Sensitivity File
.RES	Residuals Tabular File
.REI	Iteration Interim Residuals File
.SVD	Truncated Singular Value Decomposition File
.LSQ	Least Squares Solver Records File
.JCO	Jacobian Matrix Best Parameters File
.PAR	Best Parameter Value File
.BPA	Best Base Parameter File
.RSD	Regularized Inversion Resolution Data File
.REI	Interim Residuals File
.RST	Restart Incomplete Run File
.JAC	Restart Incomplete Run File
.JST	Restart Incomplete Run File
.RMR	Parallel Run Management Record
.RDY	Parallel Run Management Record
.RMR	Parallel Run Management Record
.FIN	Parallel Run Management Record

See also

- [PEST Homepage](#)
- [Parameters](#)

- [Automated Parameter Estimation](#)
- [PEST Manual](#)
- [Addendum to PEST Manual](#)
- [MODFLOW-ASP Manual](#)

Null Space Monte Carlo

The Null Space Monte Carlo (NSMC) method is used to create multiple calibrated MODFLOW models. The method is selected in the *Stochastic Options* dialog, however, the option requires that the model has already been calibrated using PEST SVD-Assist.

There is always a significant amount of uncertainty associated with a groundwater model. This uncertainty can be associated with the conceptual model or the field data or the input parameters of the model. Some model parameters, such as hydraulic conductivity, are particularly prone to uncertainty. This uncertainty can be reduced by calibrating a model to observation data (monitoring wells, stream flows, etc.). However, even a well-calibrated model can have significant uncertainty associated with it.

The challenge with a groundwater model is to explore the uncertainty while maintaining a calibrated model (good fit with field measured values). The generation of model input parameters that will respect calibration constraints is a time consuming matter since a parameter estimation exercise must be undertaken for each new set of parameters. However, two tools provided with PEST greatly reduce the amount of time required to perform calibration-constrained Monte Carlo analysis of a groundwater model. The first is the use of SVD-Assist in the calibration process. The second is the pre-calibration null space[1]projection of differences between the stochastic parameter fields and the simplified “calibration parameter field” that is decreed to “calibrate the model”. By using both of these utilities it is possible to obtain parameter sets that respect both the stochastic variability of the subsurface as well as the field measured values; this is accomplished with only a handful of runs per realization.

NSMC is a method for quantifying the amount of uncertainty associated with the prediction. Instead of creating a single calibrated model, PEST NSMC is used to create multiple calibrated models. The model can be modified to account for future conditions, then multiple models can be run using the different parameter values that PEST calculated. A distribution of results for this prediction can then be viewed.

There are many steps involved in running PEST with the Null Space Monte Carlo method.

GMS runs several PEST utilities to make all of this happen. The following is a list of the steps involved:

1. PEST runs MODFLOW once for each parameter to compute a Jacobian matrix. In this case, there is a steady state model and Parallel PEST is being used, so this step is completed fairly quickly.
2. PPCOV is a PEST utility that generates uncertainty information for the pilot points. The PPCOV utility generates a covariance matrix for the pilot points. This matrix is created using the variogram that is specified as part of the interpolation options for the pilot points. For this reason, kriging must be used with the pilot points if using the Null Space Monte Carlo method.
3. RANDPAR is a PEST utility that generates random values for the parameters that are being randomized, saving one file for each realization.
4. PNULPAR is a PEST utility that modifies the random parameter values through Null Space projection, generating one file for each realization. An explanation of how PNULPAR calculates values is given below:

In this process the difference is first taken between each parameter set and the calibration parameter; this difference is then projected onto the calibration null space, and the projected difference re-added to the calibration parameter set. If the model were linear, and if the cutoff between null and solution spaces were sharp, each new parameter set obtained in this way would calibrate the model with an identical objective function to that achieved using the calibration parameter set. However, in general, random parameter sets modified in this manner do not result in perfectly calibrated models, and will thus require adjustment in order that calibration constraints be respected. Such adjustment takes place through alterations made to the calibration solution space (leaving the null space untouched).

5. SVDAPREP is a PEST utility that creates a new PEST input file (PST) using information from the original PEST run in step 1. PEST then runs SVD-assisted parameter estimation, greatly reducing the number of model runs required for each

PEST iteration.

6. For each realization, two steps are required:

1. PARREP is a PEST utility that substitutes the parameter values generated by PNULPAR in step 4 for the current realization.
2. PEST is launched using the parameter values for the current realization and runs until the objective function is at or below PHISTOPTHRESH or until that maximum number of PEST iterations is reached.

Monte Carlo Options

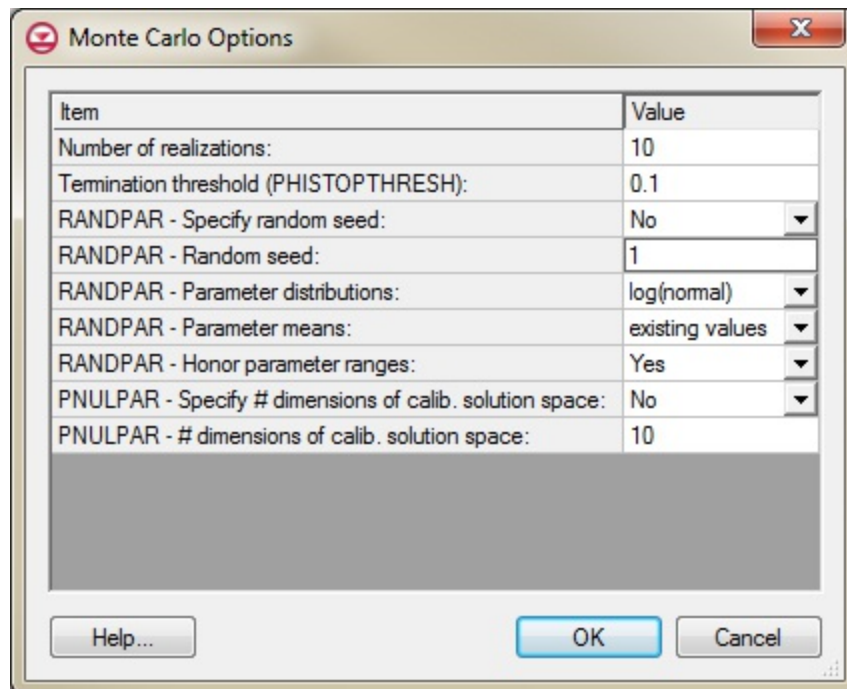

The Monte Carlo Options dialog

The *Monte Carlo Options* dialog is reached through the *Stochastic Options* dialog by selecting the **Options** button available when the *PEST NSMC* option is selected. The dialog has the following options:

- *Number of realizations*: Enter a positive value.
- *Termination threshold (PHISTOPTHRESH)*: This value tells PEST to stop when the total model error is the specified value or less.
- *RANDPAR – Specify random seed*: Set to "Yes" to change the random seed defaults. Set to "No" to keep default values.

- *RANDPAR – Random seed*: Enter a positive integer specified to allow replication of the results of the sample solution. Random number sequences are identical for the same random number seed.
- *RANDPAR – Parameter distributions*: Choose between two probability distributions for random number generation.
 - "log(normal)": Requires parameter variances/covariances to be supplied.
 - "log(uniform)": In this case the upper and lower end of the parameter range is taken as the upper and lower bounds of respective parameters as recorded in the PEST control file. If a parameter is log-transformed, then the log of the parameter is assumed to possess a uniform distribution rather than the parameter itself. No correlation is permitted between parameter values if a uniform distribution is specified.
- *RANDPAR – Parameter means*: In generating random numbers which belong to a normal distribution, a mean value is required.
 - "existing values": Accept the initial parameter value set in the control file.
 - "range midpoints": Compute the mean as midway between the lower and upper bound of each parameter set in the control file.
- *RANDPAR – Honor parameter ranges*: In preserving the ratios between tied and parent parameter values, the former may transgress their bounds as the latter are assigned random values between those bounds. Can be set to "No" or "Yes".
 - "No": Ignores the fact that tied parameters may transgress their bounds.
 - "Yes": The tied parameters are clipped at their bounds, thereby destroying the tied parameter.
- *PNULPAR – Specify # dimensions of calib. solution space*: Enter "Yes" or "No".
 - "No": Will not constrain calibration.
 - "Yes": Will use calibration constraint entered in the next field.
- *PNULPAR – # dimension of calib. solution space*: Enter a positive integer to constrain the calibration. See PEST manual for more information.

Related Topics

- [PEST](#)
- [Stochastic Options Dialog](#)

6.10. PHT3D

PHT3D

PHT3D is a multicomponent transport model for three-dimensional reactive transport in saturated porous media developed and maintained by Henning Prommer and Vicent Post. PHT3D is a combination of MT3DMS and PHREEQC-2. The PHREEQC component allows for a variety of low temperature aqueous geochemical reactions.

The PHT3D model can be added to a [paid edition](#) of GMS.

Basic Transport Package

To use PHT3D, select *PHT3D* as the Model in the *Basic Transport Package* dialog.

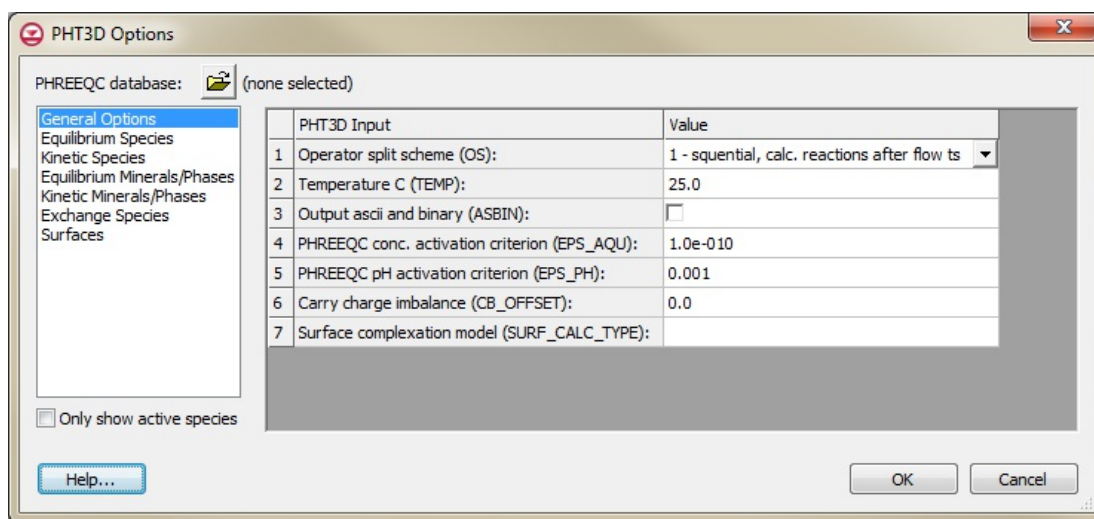

The PHT3D Options dialog

Define Species

The options that are specific to PHT3D are entered when defining the species for the simulation. When the **Define Species** button is selected the *PHT3D Options* dialog comes up. In addition to defining the species for the simulation, enter options specific to PHT3D (such as temperature, activation criterion etc.) See the PHT3D documentation for more information on specific variables in this dialog.

PHT3D requires as part of its input a PHREEQC database file. The species that can be included in the simulation depend on the contents of the PHREEQC database file. The browser button near the top of the *PHT3D Options* dialog allows selecting a PHREEQC database file. GMS will parse the contents of this file and make available the species listed in the file. There is also the option to select a PHT3D-PHREEQC interface file. When an interface package file is chosen GMS assumes that the PHREEQC database file is in the same directory with the name pht3d_datab.dat. In addition to parsing the PHREEQC database, the interface file is also read and any options that are specific to the species are imported.

The PHREEQC database file can contain many species. When only using a small subset of the available species in the database, it is useful to only show the species that are active (in use). The *Only show active species* check box hides all of the species that are not active. All other inputs to PHT3D are the same as MT3DMS. For more information on how to use PHT3D refer to the GMS tutorials.

6.11. RT3D

RT3D

RT3D (Reactive multi-species Transport in 3-Dimensional groundwater systems) is a model developed by the [Pacific Northwest National Laboratory](#). RT3D is a modified version of MT3DMS that utilizes alternate chemical reaction packages. Numerous pre-defined reactions are available and an option is provided for creating user-defined reactions. RT3D is well-suited for simulating natural attenuation and bioremediation.

Since RT3D is a modified version of MT3DMS, most of the input to RT3D is identical to the input required for MT3DMS. Thus, the RT3D interface is contained within the *MT3D* menu in the 3D Grid module. In the [Basic Transport Package](#) dialog, an option is provided for selecting the current model as either MT3DMS, RT3D, or SEAM3D. A number of options in the interface then change based on which model is selected.

Since much of the RT3D interface is identical to the [MT3DMS Interface](#), only the portions of the interface which are unique to RT3D are described in this help file.

The RT3D model can be added to a [paid edition](#) of GMS.

Basic Transport Package

The first step in defining an RT3D simulation is to define the data required by the Basic Transport (BTN) package. The options in the [Basic Transport Package dialog](#) unique to RT3D are as follows:

Packages

The **Packages** button brings up the *Packages* dialog. If the RT3D model is the current model and the *Chemical Reaction package* option is selected, one of the RT3D reactions must be selected from the pull-down list. The first nine reaction modules are pre-defined (specified as the IREACT value):

- No reaction (tracer transport)

- Inst. Aerobic Deg. of BTEX
- Inst. Deg. of BTEX w/ MEA
- Kinetic-Limited Deg. of BTEX w/ MEA
- Rate-Limited Sorption Reactions
- Double Monod Model
- Sequential Decay Reactions
- Aerobic/Anaerobic PCE/TCE Dechlorination
- Test Model #1
- Test Model #2

If one of these reactions is selected, the names of the species and the names of the reaction parameters are automatically determined by GMS. The last reaction is a user-defined reaction. If this option is selected, a list of species and list of reaction parameters must be specified.

For more information on each reaction package, see the [RT3D Reaction Packages](#) article.

Define Species

For most of the reaction package options, once the reaction package is selected, the list of species used by the package is automatically initialized by GMS. However, if the user-defined reaction package is selected, the **Define Species** button is undimmed in the *Basic Transport Package* dialog and a list of species must be manually defined before any concentrations are assigned to sources/sinks.

Chemical Reactions Package

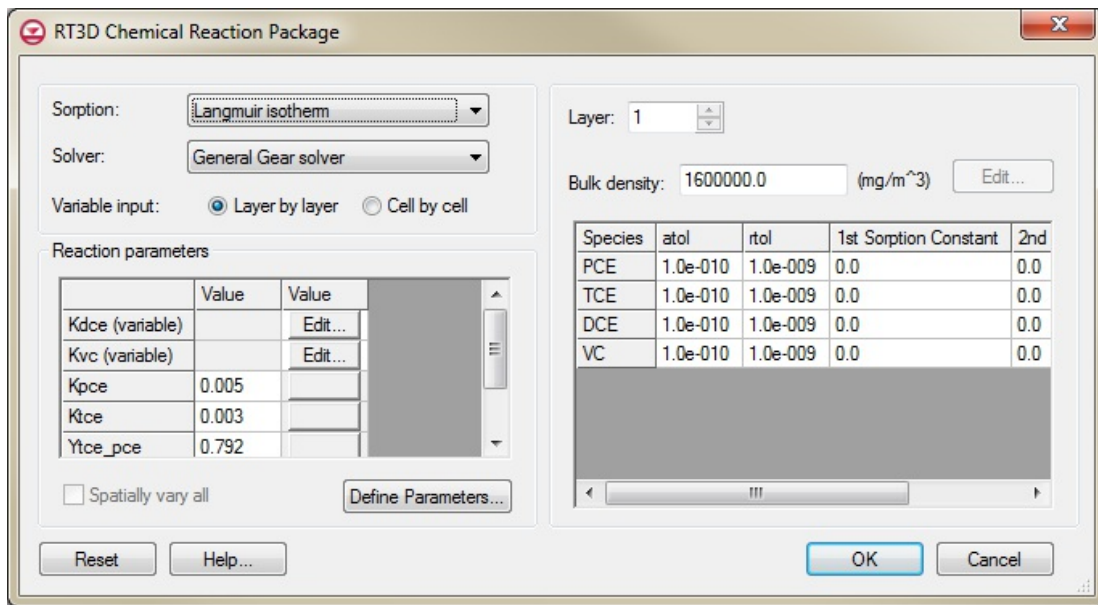

The RT3D Chemical Reaction Package dialog

The *Chemical Reactions Package* dialog utilized by RT3D is different from the *MT3DMS Chemical Reactions* dialog. The items in the dialog unique to RT3D are as follows:

Solver

If the selected reaction package is a kinetic reaction, several solvers are available for the solution of the chemical reaction equations. The desired solver should be selected from the *Solver* pull-down list. When one of these solvers is used, an absolute and relative tolerance must be specified for each of the mobile species using the *atol* and *rtol* parameters.

Reaction Parameters

With each reaction package, a set of reaction parameters must be defined. The method used to edit the reaction parameters depends on whether the reaction is a pre-defined reaction or a user-defined reaction.

Pre-Defined Reactions

For the pre-defined reactions, the number of reaction parameters and the names of the parameters are fixed. If the *Spatially vary all* toggle is off, a single value is entered for each parameter using the edit field below the parameter list. If the *Spatially vary all* toggle is on, an array of values is entered for each parameter using the **Edit** button. In this case, the

cell-by-cell parameter values can also be edited using the **Cell Attributes** command.

User-Defined Reactions

For user-defined reactions, the list of reaction parameters must be defined using the **Define Parameters** button. This button brings up the *Define Parameters* dialog. This dialog functions similarly to the *Define Species* dialog. The **New** and **Delete** buttons are used to add and remove items from the list. The **Import** button is used to read a previously defined list of reaction parameters from an RT3D super file (*.rts).

With the pre-defined reactions, the reaction parameters are either all spatially variable or all constant. However, with the user-defined reaction option, selected parameters may be designated as spatially variable while others are designated as constant. The variable/constant status of a parameter is selected using the *Spatially variable* toggle in the *Define Parameters* dialog.

RT3D Files

Below is a table of available RT3D files.

- For more information on these files see pages 11–38 of the original RT3D online documentation ([\[1\]](#)).

Name	Description
ADV	Advection Package File
BTN	Basic Transport File
CON	Concentration Output File
DSP	Dispersion Package File
DSS	Data Super File
MTR	GMS Results File
OUT	Output File
RCT	Chemical Reaction Package File
RTS	RT3D Super File
SSM	Sources/Sink Mixing File

RT3D Reaction Packages

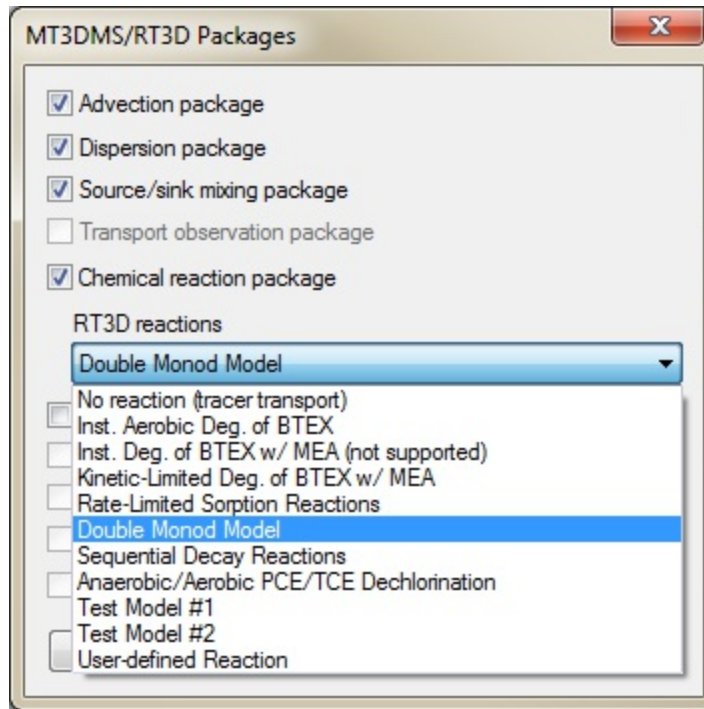

Chemical reaction packages available in the MT3D/RT3D Packages dialog

When using RT3D, GMS provides a number of reaction packages. Reaction packages are selected in the [MT3DMS/Packages](#) dialog. If one of these reactions is selected, the names of the species and the names of the reaction parameters are automatically determined by GMS.

- "No reaction (tracer transport)"
- "Inst. Aerobic Deg. of BTEX" – Instantaneous aerobic degradation of hydrocarbons. Creates two species: BTEX and Oxygen.
- "Inst. Deg. of BTEX w/MEA (not supported)"
- "Kinetic-Limited Deg. of BTEX w/MEA" – Creates species: BTEX, Oxygen, Nitrate, Iron(Fe²⁺), Sulfate, and Methane.
- "Rate-Limited Sorption Reactions" – Creates two species: Aqueous conc and Solid conc. See below.

- "Double Monod Model" – See below.
- "Sequential Decay Reactions" – See below.
- "Anaerobic/Aerobic PCE/TCE Dechlorination" – Creates two species: Electron Acceptor and Soil-phase bacteria.
- Test Model #1
- Test Model #2
- "User-defined Reaction" – Allows using a reaction defined by the user. See below.

Inst. Aerobic Deg. of BTEX

The reaction model used here simulates the instantaneous degradation of fuel hydrocarbons under aerobic conditions based on the following reaction (benzene basis):

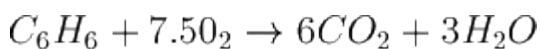

Therefore, the mass ratio of benzene to oxygen, F , is 3.08 (i.e., 3.08g of oxygen to 1g of benzene). The instantaneous removal of either contaminant (H) or oxygen (O) is dictated by the following algorithm, where t refers to a particular time step:

$$H(t+1) = H(t) - O(t)/F \text{ and } O(t+1) = 0, \text{ when } H(t) > O(t)/F$$

$$O(t+1) = O(t) - H(t) \cdot F \text{ and } H(t+1) = 0, \text{ when } O(t) > H(t) \cdot F$$

Given this algorithm, either hydrocarbon or oxygen concentration in a given grid cell will be reduced to zero at each time step, depending on which component is stoichiometrically limiting in the prior time step.

Kinetic-Limited Deg. of BTEX w/MEA

The reaction that will be simulated is biodegradation of BTEX compounds via different aerobic/anaerobic pathways using multiple electron acceptors. Five different processes

considered in this model are Aerobic Respiration (AR), Denitrification (DN), Iron (III) Reduction (IR), Sulfate Reduction (SR), and Methanogenesis (MG). All of these biochemical reactions are assumed to occur in the aqueous phase, mediated by the existing subsurface microbes, and are expected to happen in the following sequence:



The following reaction kinetic framework is used to model the degradation rate of hydrocarbon via different electron acceptor pathways:

$$r_{HC,O_2} = -k_{HC,O_2}[HC] \frac{O_2}{K_{O_2} + [O_2]}$$

$$r_{HC,NO_3} = -k_{HC,NO_3}[HC] \frac{NO_3}{K_{NO_3} + [NO_3]} \bullet \frac{K_{i,O_2}}{K_{i,O_2} + [O_2]}$$

$$r_{HC,Fe^{3+}} = -k_{HC,Fe^{3+}}[HC] \frac{Fe^{3+}}{K_{Fe^{3+}} + [Fe^{3+}]} \bullet \frac{K_{i,O_2}}{K_{i,O_2} + [O_2]} \bullet \frac{K_{i,NO_3}}{K_{i,NO_3} + [NO_3]}$$

$$r_{HC,SO_4} = -k_{HC,SO_4}[HC] \frac{SO_4}{K_{SO_4} + [SO_4]} \bullet \frac{K_{i,O_2}}{K_{i,O_2} + [O_2]} \bullet \frac{K_{i,NO_3}}{K_{i,NO_3} + [NO_3]} \bullet \frac{K_{i,Fe^{3+}}}{K_{i,Fe^{3+}} + [Fe^{3+}]}$$

$$r_{HC,CH_4} = -k_{HC,CH_4}[HC] \frac{CO_2}{K_{CH_4} + [CO_2]} \bullet \frac{K_{i,O_2}}{K_{i,O_2} + [O_2]} \bullet \frac{K_{i,NO_3}}{K_{i,NO_3} + [NO_3]} \bullet \frac{K_{i,Fe^{3+}}}{K_{i,Fe^{3+}} + [Fe^{3+}]} \bullet \frac{K_{i,SO_4}}{K_{i,SO_4} + [SO_4]}$$

where

- r_{HC,O_2} is the rate at which hydrocarbon is destroyed by utilizing oxygen,
- r_{HC,NO_3} is the rate at which hydrocarbon is destroyed by utilizing Nitrate,
- $r_{HC,Fe^{2+}}$ is the rate at which hydrocarbon is destroyed by producing Fe^{2+} (or utilizing Fe^{3+}),
- r_{HC,SO_4} is the rate at which hydrocarbon is destroyed by utilizing sulfate,
- r_{HC,CH_4} is the rate at which hydrocarbon is destroyed by producing methane,
- $[O_2]$ is the oxygen concentration $[ML^{-3}]$,
- k_{O_2} is the first-order rate constant $[T^{-1}]$,

- K_{O_2} is the Monod half saturation constant [ML^{-3}] (by setting all the half-saturation constants to a small value, zero-order dependency can be simulated with respect to the electron donor and hence a first-order degradation model with respect to hydrocarbon; the default values simulate this option), and
- K_{i,O_2} is the oxygen inhibition constant [ML^{-3}] (by setting all inhibition constants to a small value, reactions can be forced to occur in a sequential fashion; the default values simulate this process). Similar nomenclature is used to identify other Monod constants and inhibition coefficients.

Since the concentrations of Fe^{3+} and CO_2 are not readily measurable under normal field conditions, these terms were replaced with the “assimilative capacity” for iron reduction and methanogenesis, defined as the following:

$$[Fe^{3+}] = [Fe^{2+max}] - [Fe^{2+}]$$

$$[MC] = [CO_2] = [CH_{4,max}] - [CH_4]$$

where $[Fe^{2+max}]$ and $[CH_{4,max}]$ are the maximum possible aquifer levels of these species that represent the aquifer’s maximum capacity for iron reduction and methanogenesis. Note: the concentration of CO_2 used here is the CO_2 evolved while the hydrocarbon is destroyed via methanogenesis, which may be thought of as the “Methanogenic Capacity” (MC) of the aquifer. Using these relations, iron (III) reduction and methanogenesis processes may be related back to measurable Fe^{2+} and CH_4 concentration levels.

The total rate of hydrocarbon destruction, via all the above described processes, is the sum of each of the individual rates and is given as the following:

$$\frac{d[HC]}{dt} = r_{HC,O_2} + r_{HC,NO_3} + r_{HC,Fe^{2+}} + r_{HC,SO_4} + r_{HC,CH_4}$$

Rates of electron acceptor utilization are given as the corresponding rate of hydrocarbon destruction multiplied by the appropriate yield coefficient (Y):

$$\frac{d[O_2]}{dt} = Y_{O_2/HC} r_{HC,O_2}$$

$$\frac{d[NO_3]}{dt} = Y_{NO_3/HC} r_{HC,NO_3}$$

$$\frac{d[Fe^{2+}]}{dt} = Y_{Fe^{2+}/HC} r_{HC,Fe^{2+}}$$

$$\frac{d[SO_4]}{dt} = Y_{SO_4/HC} r_{HC,SO_4}$$

$$\frac{d[CH_4]}{dt} = Y_{CH_4/HC} r_{HC,CH_4}$$

The yield values (the mass ratio of electron acceptors removed or metabolic byproducts produced to total BTEX degraded) are as follows: $Y_{O_2/HC} = 3.14$, $Y_{NO_3/HC} = 4.9$, $Y_{Fe^{2+}/HC} = 21.8$, $Y_{SO_4/HC} = 4.7$, and $Y_{CH_4/HC} = 0.78$. Typical values of all inhibition coefficients, except for $K_{iFe^{3+}}$, should be in the range of 1.0 to 0.01 mg/L. $K_{iFe^{3+}}$ should always be set around 40% to 80% of the max Fe^{2+} value. Monod half-saturation constants should be in the range of 1.0 to 0.1 mg/L.

As pointed out in Lu et al. , it is important to note that this model is based on several assumptions. The model should be used with caution only at sites where these assumptions are valid.

In summary, the key assumptions used in the model are: (1) the fuel chemical species benzene, toluene, ethylbenzene, and xylene are assumed to degrade at similar rates and, hence, are combined and modeled as a single electron donor species BTEX; (2) production of Fe^{2+} and methane are restricted at a node to a “maximum-observed level”; however, the model assumes that an infinite supply of electron acceptors will be available for iron-reduction and methanogenic reactions; (3) more complex processes are not considered; these include processes such as the rate-limited interaction of bioavailable, solid-phase Fe^{3+} and aqueous-phase Fe^{2+} , interaction of oxygen and Fe^{2+} , and/or variations in the spatial pattern of methanogenic activity and CO_2 availability; (4) growth and decay of various microbial populations and their interactions with contaminants and aquifer solids are assumed to be negligible; and (5) all BTEX decay reactions are approximated as first-order reactions, and, hence, the model ignores the Monod limitation due to the electron donor

(BTEX) availability. Fortunately, these assumptions are expected to be reasonable approximations for most field sites. However, there will always be some exceptions.

Rate-Limited Sorption Reactions

The fate and transport of an organic pollutant in subsurface environments is often highly dependent on its sorption characteristics. Under most natural groundwater flow conditions, the partitioning of contaminants between the solid and aqueous phases can be assumed to be at a local equilibrium. Thus, the more widely used retardation approach for modeling sorption may provide an adequate description for the overall transport. However, the equilibrium assumption may fail when external pumping and injection stresses are imposed on an aquifer (e.g. using a pump-treat system). This would lead to some well-known conditions such as the plume tailing effect (i.e., low contaminant levels always observed at the extraction well) and/or the rebounding effect (i.e., the aquifer seems to be clean but the aqueous concentrations start to increase immediately after stopping the treatment system). These conditions cannot be simulated using the standard linear retardation approach since they require a mass-transfer description for the sorption reactions.

In the mass-transfer limited sorption model, the exchange of contaminants between the soil and groundwater is assumed to be rate limited. The rate of exchange is dictated by the value of the mass-transfer coefficient. When the mass-transfer rate is high (relative to the overall transport), the rate-limited model relaxes to the retardation model. On the other end of the spectrum, a very low mass-transfer coefficient would mimic fully sequestered conditions where the contaminants in the soil phase are assumed to be irreversibly adsorbed and trapped into the soil pores. Under this extreme condition, it might be possible to simply clean the groundwater plume and leave the sequestered soil contaminant in the aquifer because the sorbed contaminants may not pose any potential risk to the environment. In either of the extreme conditions, pump-and-treat is the best option to remediate the groundwater plume. Unfortunately, in most instances, the mass-transfer coefficient is expected to lie in an intermediate range, causing the well-known limitations to the pump-and-treat system.

When sorption is assumed to be rate limited, it is necessary to track contaminant

concentrations in both mobile (groundwater) and immobile (soil) phases. Following Haggerty and Gorelick's (1994) approach, the fate and transport of a sorbing solute at aqueous and soil phases can be predicted using the following transport equations:

$$\frac{\partial C}{\partial t} + \frac{\rho}{\Phi} \frac{\partial \tilde{C}}{\partial t} = \frac{\partial}{\partial x_j} \left(D_{ij} \frac{\partial C}{\partial x_j} \right) - \frac{\partial}{\partial x_i} (v_i C) + \frac{q_s}{\Phi} C_s$$

$$\frac{\rho}{\Phi} \frac{\partial \tilde{C}}{\partial t} = \xi \left(C - \frac{\tilde{C}}{\lambda} \right)$$

where

- C is the concentration of the contaminant in the mobile-phase [ML^{-3}],
- \tilde{C} is the concentration of the contaminant in the immobile phase (mass of the contaminants per unit mass of porous media, [MM^{-1}]),
- r is the bulk density of the soil matrix,
- Φ is the soil porosity,
- ξ is the first-order, mass-transfer rate parameter [T^{-1}], and
- λ is the linear partitioning coefficient (which is equal to the linear, first-order sorption constant K_d) [L^3M^{-1}].

It can be mathematically shown that the above model formulation relaxes to the retardation model when the value of x becomes high.

The mass-transfer model discussed above has been implemented as an RT3D reaction package (one mobile species and one immobile species). After employing reaction-operator splitting, the reaction package for the problem reduces to the following:

$$\frac{dC}{dt} = -\xi \left(C - \frac{\tilde{C}}{\lambda} \right)$$

$$\frac{d\tilde{C}}{dt} = \frac{\Phi \xi}{\rho} \left(C - \frac{\tilde{C}}{\lambda} \right)$$

These two differential equations are coded into the model #4 designated as the rate-limited sorption reaction module.

Double Monod Model

Methods for enhancing in situ bioremediation of subsurface soil and groundwater involve injection or infiltration of a carbon source (or electron donor), nutrients, and other electron acceptors to stimulate the growth of native microbes. In addition, bioengineered suspension cultures of contaminant degrading organisms may be also added to increase the amount of attached and suspended biomass in the subsurface. These two types of active remediation techniques can be used to bioremediate contaminated source zones or to establish a biobarrier to prevent plume migration and/or to enhance plume attenuation. The successful use of subsurface microbes for bioremediation requires an understanding of coupled flow, transport, and reaction processes that control bacterial growth and migration patterns. The Dual-Monod model, available in the RT3D code, can be used to develop such understanding by simulating the coupled reactive transport and microbial growth. The model is developed in a general format; therefore, the interaction between any electron donor and acceptor mediated by any type of microbial population can be simulated by varying appropriate kinetic constants. Advanced users can modify this basic formulation and couple it with other packages, such as the sorption package, to simulate more realistic bioremediation scenarios (any such modified reaction models can be easily implemented via the user-defined reaction option).

Assuming the linear-equilibrium model for modeling sorption, and the Dual-Monod model for modeling bacterial growth, the fate and transport equation for an electron donor (hydrocarbon, for example) in a multi-dimensional saturated porous media can be written as follows:

$$R_D \frac{\partial [D]}{\partial t} = \frac{\partial}{\partial X_i} \left(D_{ij} \frac{\partial [D]}{\partial X_j} \right) - \frac{\partial}{\partial X_i} (v_i [D]) + \frac{q_s}{\Phi} [D_s] - \mu_m \left([X] + \frac{\rho \tilde{X}}{\Phi} \right) \left(\frac{[D]}{K_D + [D]} \right) \left(\frac{[A]}{K_A + [A]} \right)$$

where

- [D] is the electron donor concentration in the aqueous phase [ML⁻³]

- $[D_s]$ is the donor concentration in the sources/sinks $[ML^{-3}]$,
- D_{ij} is the dispersion coefficient;
- $[X]$ is the aqueous phase bacterial cell concentration $[ML^{-3}]$,
- \tilde{X} is the solid-phase cell concentration (mass of bacterial cells per unit mass of porous media $[MM^{-1}]$),
- $[A]$ is the electron acceptor concentration in the aqueous phase $[ML^{-3}]$,
- R_H is the retardation coefficient of the hydrocarbon,
- K_D is the half-saturation coefficient for the electron donor $[ML^{-3}]$,
- K_A is the half-saturation coefficient for the electron acceptor $[ML^{-3}]$, and
- μ_m is the contaminant utilization rate $[T^{-1}]$.

The model assumes that the degradation reactions occur only in the aqueous phase, which is usually a conservative assumption.

The fate and transport of the electron donor (oxygen, for example) can be modeled using this equation:

$$R_A \frac{\partial [A]}{\partial t} = \frac{\partial}{\partial X_i} \left(D_{ij} \frac{\partial [A]}{\partial X_j} \right) - \frac{\partial}{\partial X_i} (v_i [A]) + \frac{q_s}{\Phi} [A_s] - Y_{A/D} \mu_m \left([X] + \frac{\rho \tilde{X}}{\Phi} \right) \left(\frac{[D]}{K_D + [D]} \right) \left(\frac{[A]}{K_A + [A]} \right)$$

where

- $Y_{A/D}$ is the stoichiometric yield coefficient, and R_A is the retardation coefficient of the electron acceptor.

The fate and transport of bacteria in the aqueous phase can be described using this equation:

$$\frac{\partial [X]}{\partial t} = \frac{\partial}{\partial X_i} \left(D_{ij} \frac{\partial [X]}{\partial X_j} \right) - \frac{\partial}{\partial X_i} (v_i [X]) + \frac{q_s}{\Phi} [X_s] - K_{att} [K] + \frac{K_{det} \rho \tilde{X}}{\Phi} + Y_{X/D} \mu_m [X] \left(\frac{[D]}{K_D + [D]} \right) \left(\frac{[A]}{K_A + [A]} \right) + K_e [X]$$

where

- K_{att} is the bacterial attachment coefficient $[T^{-1}]$,
- K_{det} is the bacterial detachment coefficient $[T^{-1}]$, and
- K_e is the endogenous cell death or decay coefficient $[T^{-1}]$.

The growth of attached-phase bacteria can be described using an ordinary differential equation of the form:

$$\frac{d\tilde{X}}{dt} = \frac{K_{att}\Phi[X]}{\rho} - K_{det}\tilde{X} + Y_{X/D}\mu_m\tilde{X}\left(\frac{[D]}{K_D + [D]}\right)\left(\frac{[A]}{K_A + [A]}\right) - K_e\tilde{X}$$

The conceptual model used here for representing attached bacteria cells is similar to the macroscopic model described by Baveye and Valocchi (1989). The model also assumes first-order kinetic expressions for representing bacterial attachment and detachment processes (Taylor and Jaffé, 1990; and Hornberger et al., 1992). Permeability and porosity changes caused by bacterial growth are ignored in this formulation. However, if required, macroscopic models for biomass-affected porous-media properties described by Clement et al. (1996) may be integrated within this modeling approach. It should be noted that a lot of active research is currently underway to gain an increased understanding of bacteria transport in porous media because currently available bacterial transport models (including the model used here) are arguably approximate. Therefore, application of this model to real situations should be always supported by field- or laboratory-scale data.

The reactive-transport model discussed above was set up as a RT3D reaction package with three mobile species (to represent electron donor, electron acceptor, and aqueous bacteria) and one immobile species (to represent attached soil bacteria). After employing the reaction-operator splitting strategy, the reaction package for the problem reduces to the following:

$$\frac{d[D]}{dt} = -\frac{\mu_m}{R_D}\left([X] + \frac{\rho\tilde{X}}{\Phi}\right)\left(\frac{[D]}{K_D + [D]}\right)\left(\frac{[A]}{K_{[A]} + [A]}\right)$$

$$\frac{d[A]}{dt} = -\frac{Y_{A/D}\mu_m}{R_A}\left([X] + \frac{\rho\tilde{X}}{\Phi}\right)\left(\frac{[D]}{K_D + [D]}\right)\left(\frac{[A]}{K_A + [A]}\right)$$

$$\frac{d[X]}{dt} = -Y_{X/D}\mu_m\left([X] + \frac{\rho\tilde{X}}{\Phi}\right)\left(\frac{[D]}{K_D + [D]}\right)\left(\frac{[A]}{K_A + [A]}\right) + \frac{K_{det}\rho\tilde{X}}{\Phi} - K_{att}[X] - K_e[X]$$

$$\frac{d\tilde{X}}{dt} = \frac{K_{att}\Phi[X]}{\rho} - K_{det}\tilde{X} + Y_{X/D}\mu_m\tilde{X}\left(\frac{[D]}{K_D + [D]}\right)\left(\frac{[A]}{K_A + [A]}\right) - K_e\tilde{X}$$

These four equations are coded into the double-monod reaction module.

Sequential Decay Reactions

The reaction being simulated is anaerobic PCE dechlorination with sequential, first-order, degradation kinetics. Degradation of PCE all the way to VC is assumed to be anaerobically favorable and the degradation kinetics are assumed to be first order in nature.

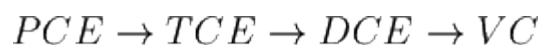

The following set of equations describes the reaction kinetics framework:

$$r_{PCE} = -k_1[PCE]$$

$$r_{TCE} = k_1 Y_{TCE/PCE}[PCE] - k_2[TCE]$$

$$r_{DCE} = k_2 Y_{DCE/TCE}[TCE] - k_3[DCE]$$

$$r_{DCE} = k_3 Y_{VC/DCE}[DCE] - k_4[VC]$$

Kinetic Constants (to be manually entered):

Constant	Value	Designation
k_1	0.005 day ⁻¹	PCE anaerobic constant
k_2	0.003 day ⁻¹	TCE anaerobic constant
k_3	0.002 day ⁻¹	DCE anaerobic constant
k_4	0.001 day ⁻¹	VC anaerobic constant

The following constants (yields in mg/mg basis) are fixed internally:

Constant	Value	Designation
$Y_{TCE/PCE}$	0.7920	TCE:PCE stoichiometric yield
$Y_{DCE/TCE}$	0.7377	DCE:TCE stoichiometric yield
$Y_{VC/DCE}$	0.6445	VC:DCE stoichiometric yield

User-Defined Reactions

User-defined reaction packages can be created using one of two approaches: the dynamically linked library (DLL) option or the linked subroutine option. With the DLL option,

the subroutine for the reaction package is compiled as a stand-alone DLL. The DLL is then copied to the same directory as the RT3D executable, and the DLL is automatically launched by RT3D when RT3D is executed. The DLL can be recompiled, or a new DLL can be used simply by copying the new DLL to the same directory as the RT3D executable and naming it appropriately. The RT3D executable does not need to be recompiled.

With the linked subroutine option, the code for the new reaction subroutine is compiled and linked with the rest of the RT3D source code (or the RT3D library made for a specific computer platform). In other words, the RT3D executable must be recompiled each time the reaction package is modified.

Because of the portability of the developed reaction package, the DLL option is the more convenient of the two options. However, the DLL option is only available on the Windows platform. It is not available on Unix.

Reaction module developers are considered advanced users of the RT3D code. The required background is as follows:

- Should have a basic understanding of the functionality of RT3D code and understand how different types of components (mobile and immobile) are mathematically described within RT3D modeling framework.
- Should be familiar with GMS and be able to create MODFLOW and RT3D input files with little effort.
- Should be familiar with the data structure of RT3D input files such as BTN, SSM, and RCT files.
- Should have a basic understanding of the FORTRAN language and have access to A Digital FORTRAN compiler (or a UNIX-system-based FORTRAN 90 compiler).
- Should have some background or understanding of biochemical reaction kinetics. Note: Inappropriate kinetic expressions and/or kinetic constants may lead to unpredictable code behavior.
- Should be familiar with contaminant transport equations and coupled nonlinear differential equations.

Related Topics

- [RT3D](#)
- [MT3D/RT3D Packages](#)

6.12. SEAM3D

SEAM3D

SEAM3D (Sequential Electron Acceptor Model, 3D) is a reactive transport model used to simulate complex biodegradation problems involving multiple substrates and multiple electron acceptors. It is based on the MT3DMS code. In addition to the regular [MT3DMS](#) modules, SEAM3D includes a Biodegradation package and NAPL Dissolution package. SEAM3D was developed by Mark Widdowson at Virginia Tech University.

Since SEAM3D is a modified version of MT3DMS, most of the input to SEAM3D is identical to the input required for MT3DMS. Thus, the SEAM3D interface is contained within the [MT3DMS](#) menu in the 3D Grid module. In the [Basic Transport Package dialog](#), an option is provided for selecting the current model as either [MT3DMS](#), [RT3D](#), or SEAM3D. A number of options in the interface then change based on which model is selected.

SEAM3D requires using the [Chemical Reaction](#) package and the [Biodegradation](#) package. It also allows using the [NAPL Dissolution](#) package, the [Cometabolism](#) package, and the [Reductive Dechlorination](#) package.

The SEAM3D model can be added to a [paid edition](#) of GMS.

SEAM3D Biodegradation Package

The *Biodegradation Package* is used with the [SEAM3D](#) model to set estimated parameters for the disintegration of materials by bacteria, fungi, or other biological means. Estimation of model parameters for biodegradation may be based on laboratory measurements, published values, and theoretical estimates. To produce maximum flexibility, SEAM3D allows parameters to vary across the aquifer layers and among the various substrates and electron acceptors for biodegradation.

The dialog is reached through the *SEAM3D* | **Biodegradation Package** command.

Minimum Concentration

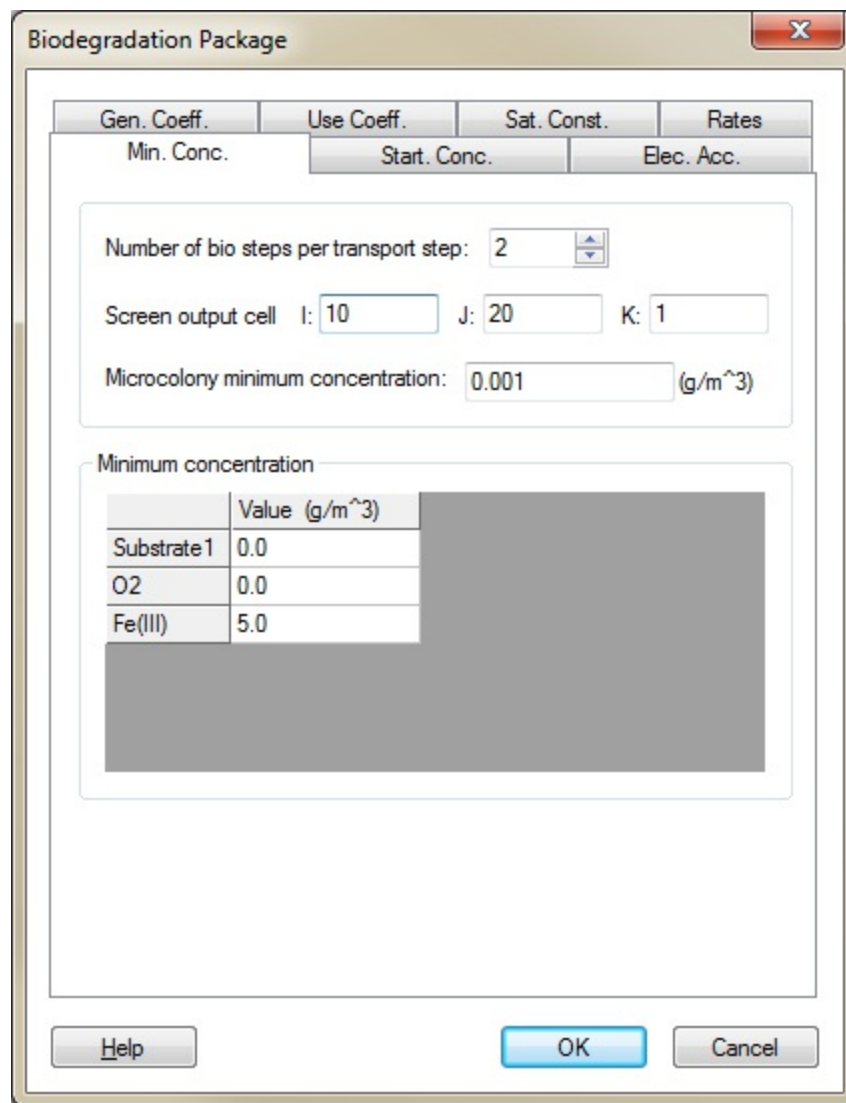

SEEM3D Biodegradation Package dialog showing the Minimum Concentration tab

- Number of bio steps per transport step
- Screen output cell
- Microcolony minimum concentration
- *Minimum concentration* – This table allows setting a minimum concentration for a defined species. If the concentration of defined species falls below a minimum value, then utilization of that species ceases.

Starting Concentration

The *Start. Conc.* tab allows setting an initial concentration for defined species. Clicking the **Edit** button will open an array editor called the *Starting Concentration Array*.

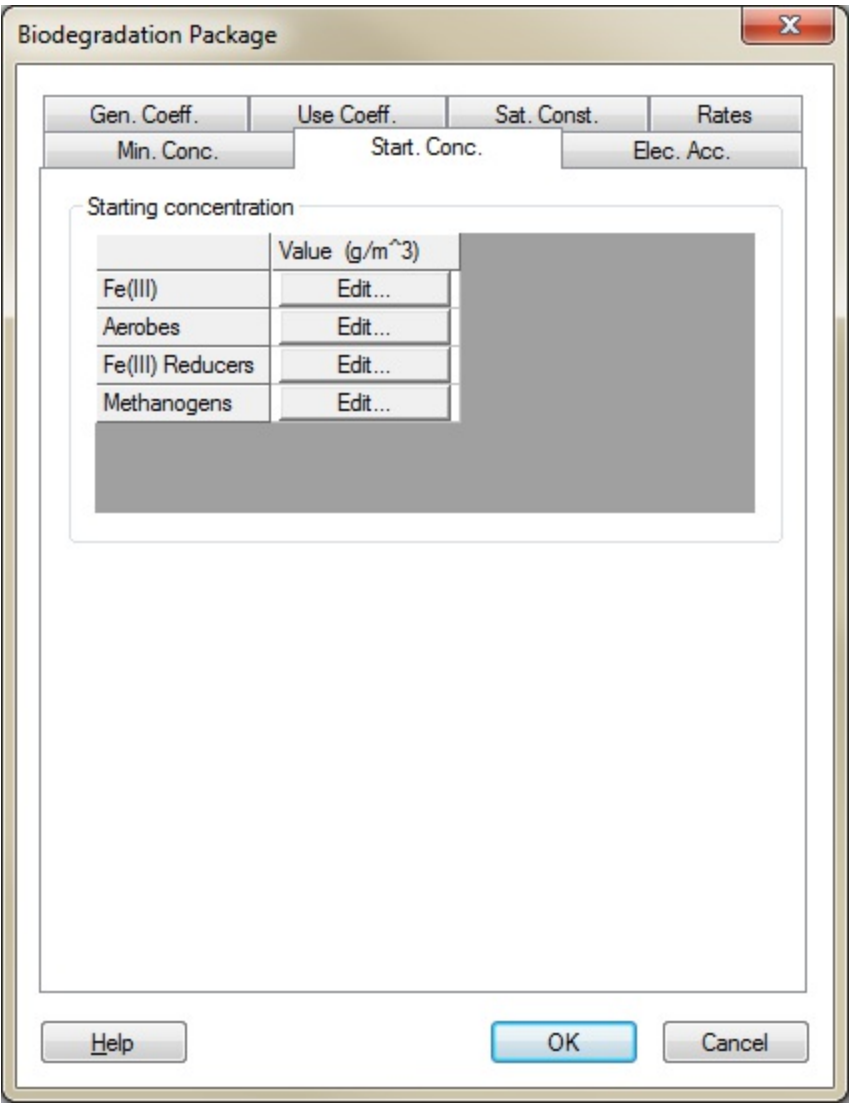

SEEM3D Biodegradation Package dialog showing the Starting Concentration tab

Electron Acceptor

This tab allows setting the *inhibition coefficient* and the *Yeild coefficient* for defined species.

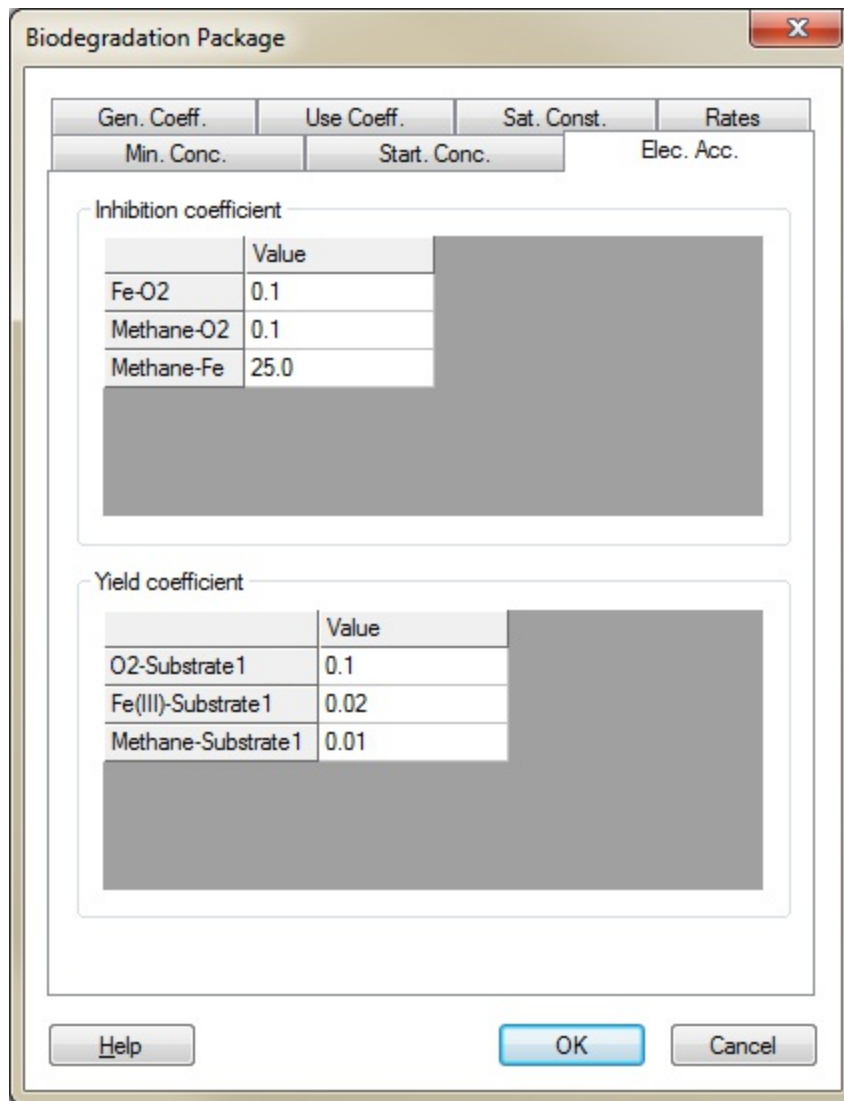

SEEM3D Biodegradation Package dialog showing the Electron Acceptor tab

General Coefficient

This tab allows setting the *Product coefficient*, *Methane coefficient*, and *Daughter coefficient* for certain species.

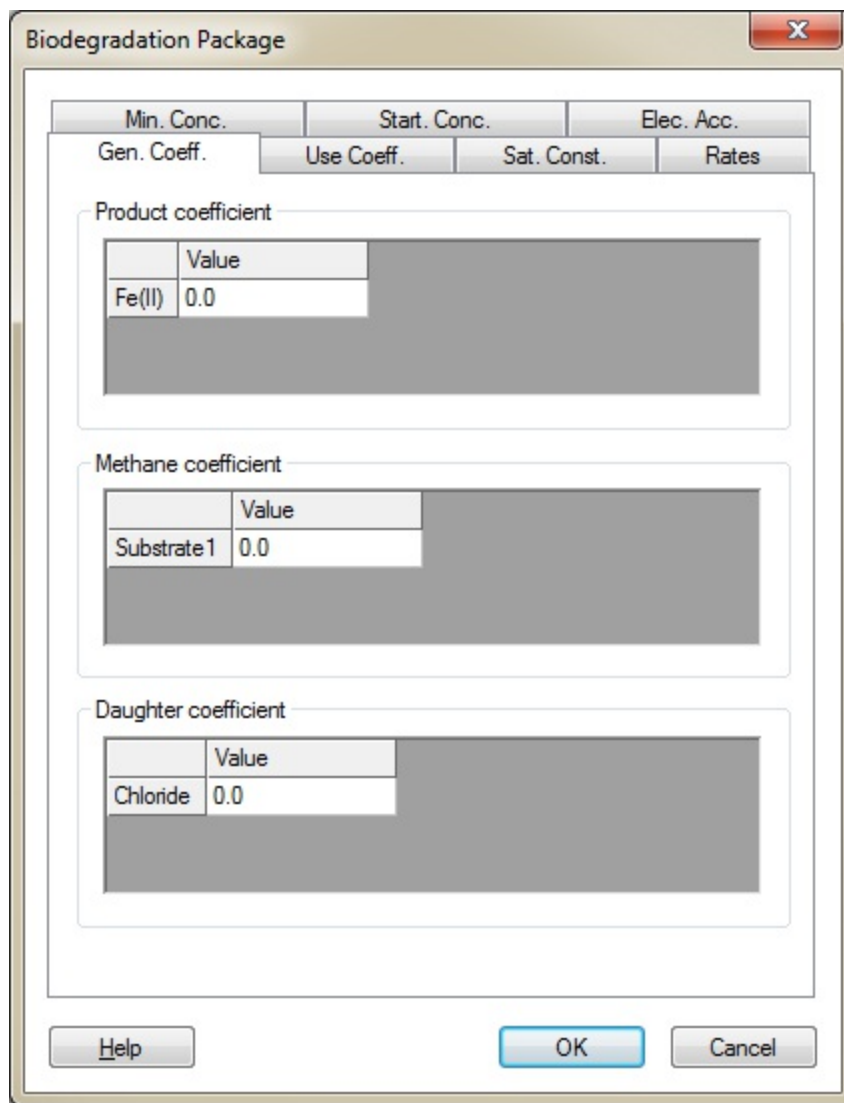

SEEM3D Biodegradation Package dialog showing the General Coefficient tab

Use Coefficient

There are two use coefficients that can be defined: the *Electron acceptor use coefficient* and the *Nutrient use coefficient*.

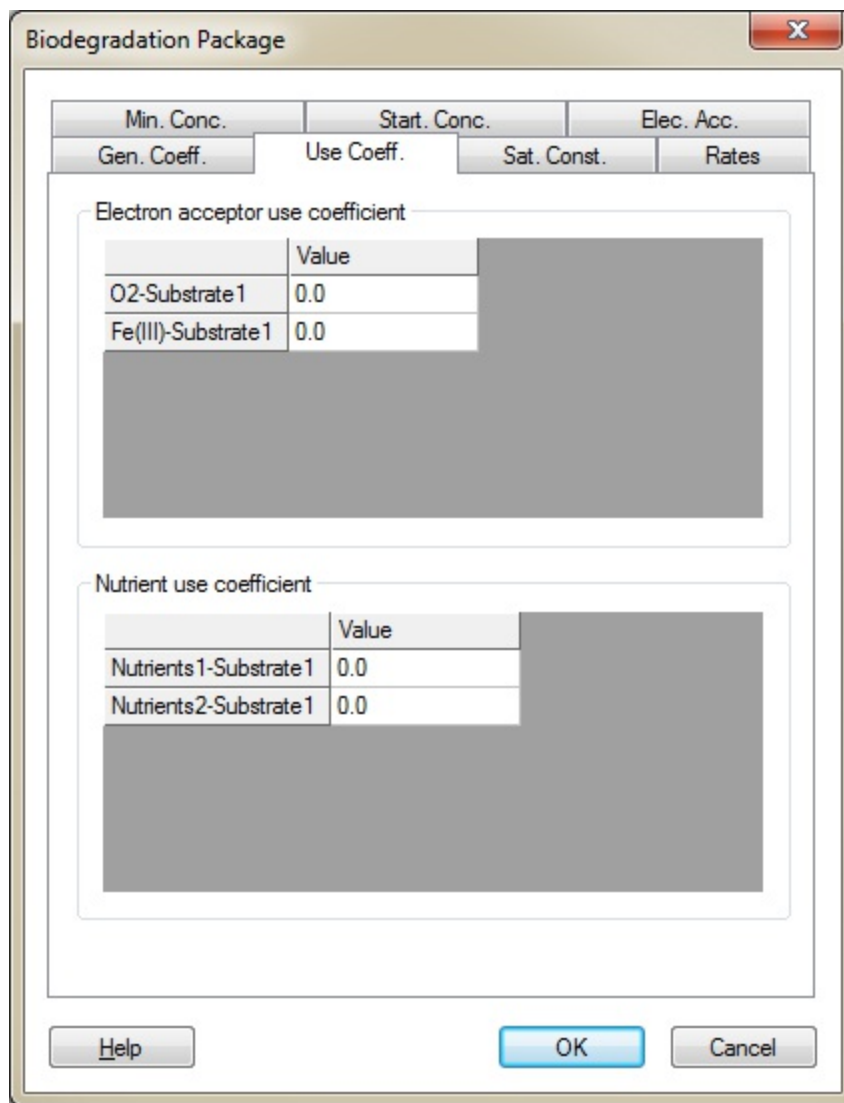

SEEM3D Biodegradation Package dialog showing the Use Coefficient tab

Saturation Constant

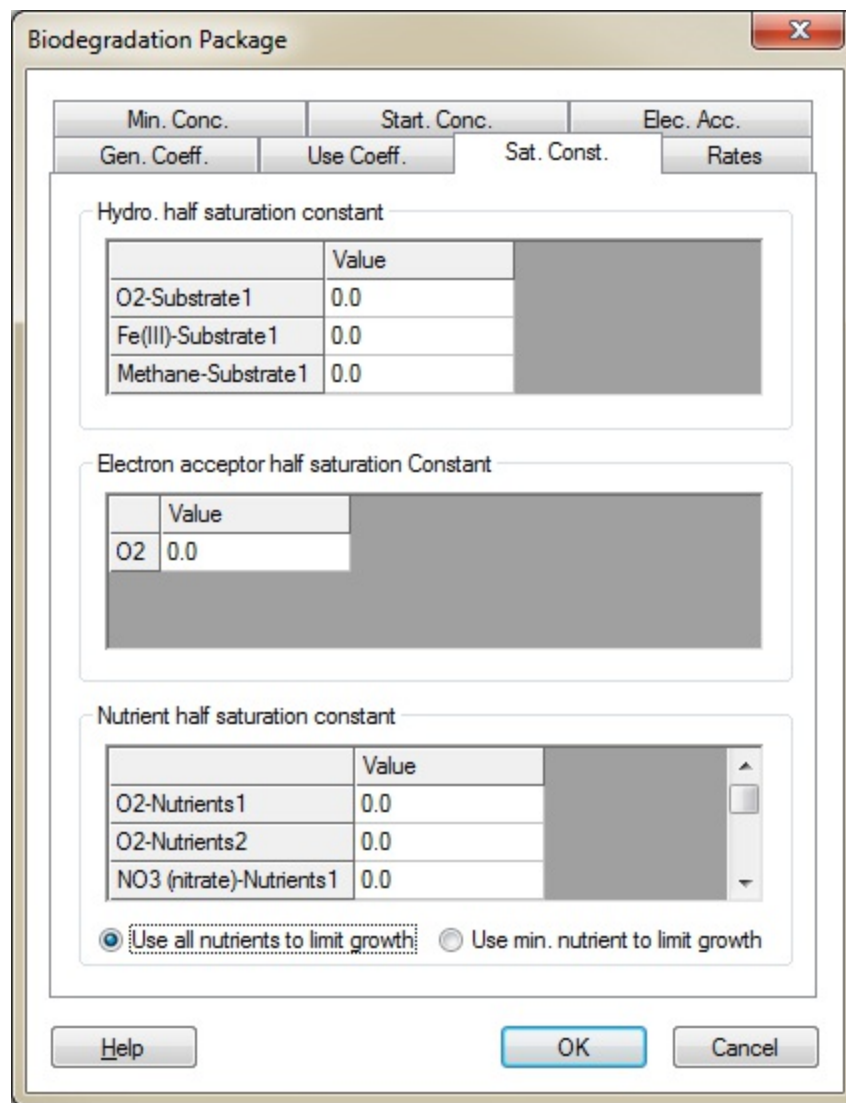

SEEM3D Biodegradation Package dialog showing the Saturation Constant tab

- Hydrocarbon half saturation constants
- Electron acceptor half saturation constants
- Nutrient half saturation constant
 - Use all nutrients to limit growth
 - Use minimum nutrient to limit growth

Rate

- Death Rate

- Calculated by model
- No death
- Constant
- Maximum specific rate of substrate utilization
 - *Vary spatially* – When turned on, allows spatial variability for the maximum specific rate of substrate utilization. Clicking the **Edit** button will open an array editor called the *Maximum Rate of Substrate Utilization Array*.

Biodegradation Package

Min. Conc.	Start. Conc.	Elec. Acc.
Gen. Coeff.	Use Coeff.	Sat. Const.
Rates		

Death rate

	Value	
Aerobes	0.0	
Fe(II) Reducers	0.0	
Methanogens	0.0	

Calculated by model
 No death
 Constant

Max. specific rate of substrate utilization

	Value	
O2-Substrate 1	0.0	
Fe(III)-Substrate 1	0.0	
Methane-Substrate 1	0.0	

Vary spatially

Help OK Cancel

SEEM3D Biodegradation Package dialog showing the Rate tab

SEAM3D Cometabolism Package

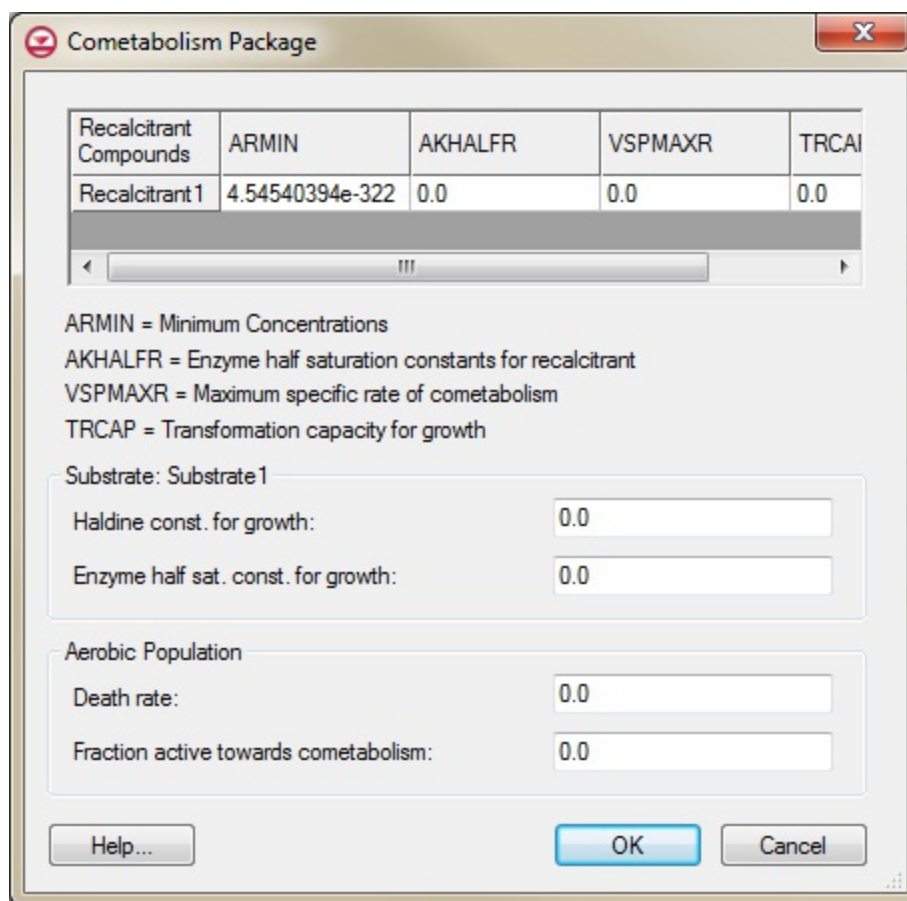

The SEAM3D Cometabolism Package dialog

The SEAM3D Cometabolism Package is designed to simulate aerobic cometabolism of user-designated recalcitrant compounds (recalcitrants). Cometabolism of recalcitrants is assumed to result from aerobic oxidation of methane or petroleum-derived compounds (e.g., toluene). Recalcitrants may be three of the four chloroethenes (PCE is not included as a possible recalcitrant compound) or any user-defined compound (e.g., MTBE).

The dialog is reached through the *SEAM3D* | **Cometabolism Package** command. The dialog has the following options:

- Recalcitrant Compounds
 - ARMIN

- AKHALFR
- VSPMAXR
- TRCAP

- Substrate
 - Haldine constant for growth
 - Enzyme half saturation constant for growth

- Aerobic Population
 - Death rate
 - Fraction active towards cometabolism

SEAM3D Reductive Dechlorination Package

The *Reductive Dechlorination Package* is an optional package in the [SEAM3D](#) model that can be used to account for the degradation of chlorinated organic compounds by chemical reduction with release of inorganic chloride ions. The dialog is reached through the *SEAM3D | Reductive Dechlorination Package* command.

Concentrations

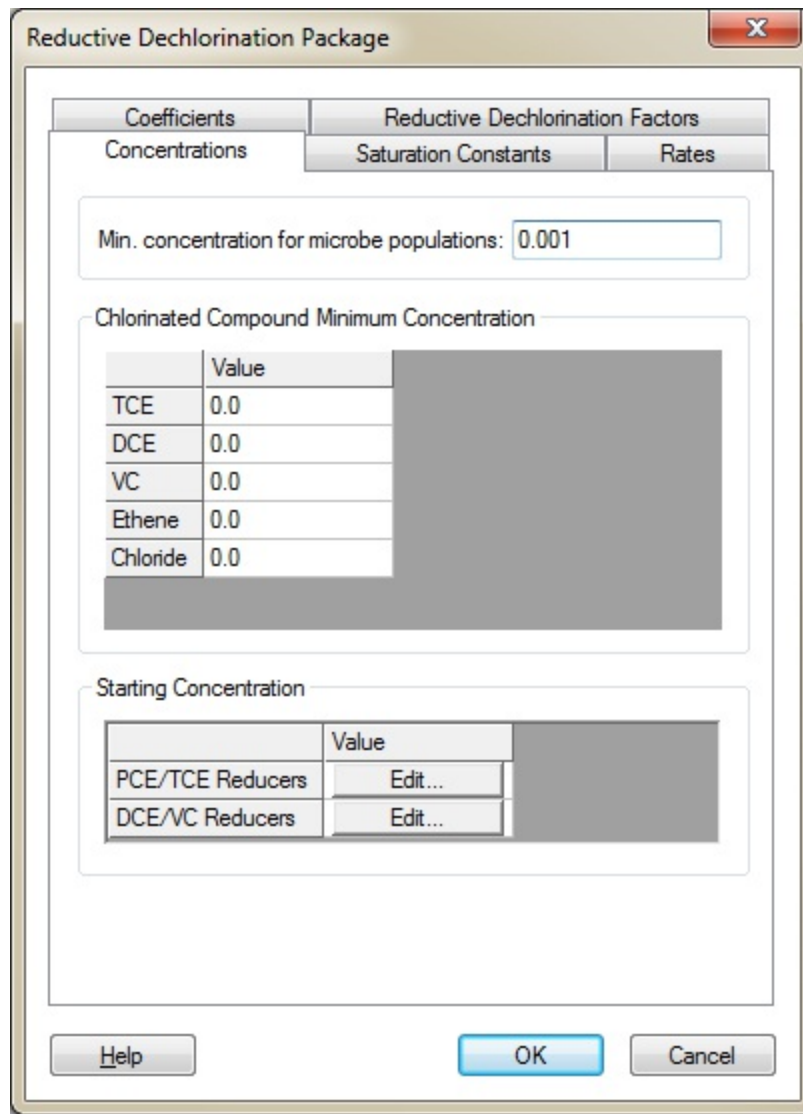

The SEAM3D Reductive Dechlorination Package showing the Concentrations tab

- Minimum concentration for microbe populations
- Chlorinated Compound Minimum Concentration
- Starting Concentration

Saturation Constants

This tab allows setting *Half Saturation Constant for Reductive Dechlorination* and *Half Saturation Constant for Direct Oxidation* values.

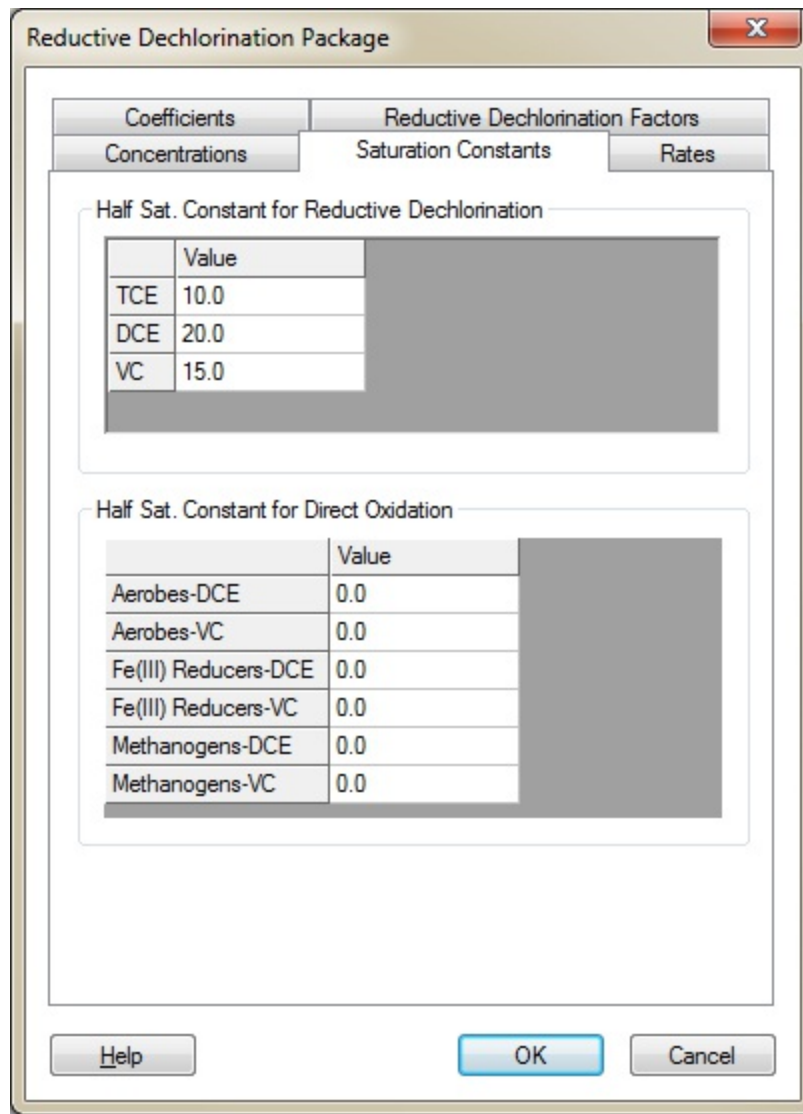

The SEAM3D Reductive Dechlorination Package showing the Saturation Constants tab

Rates

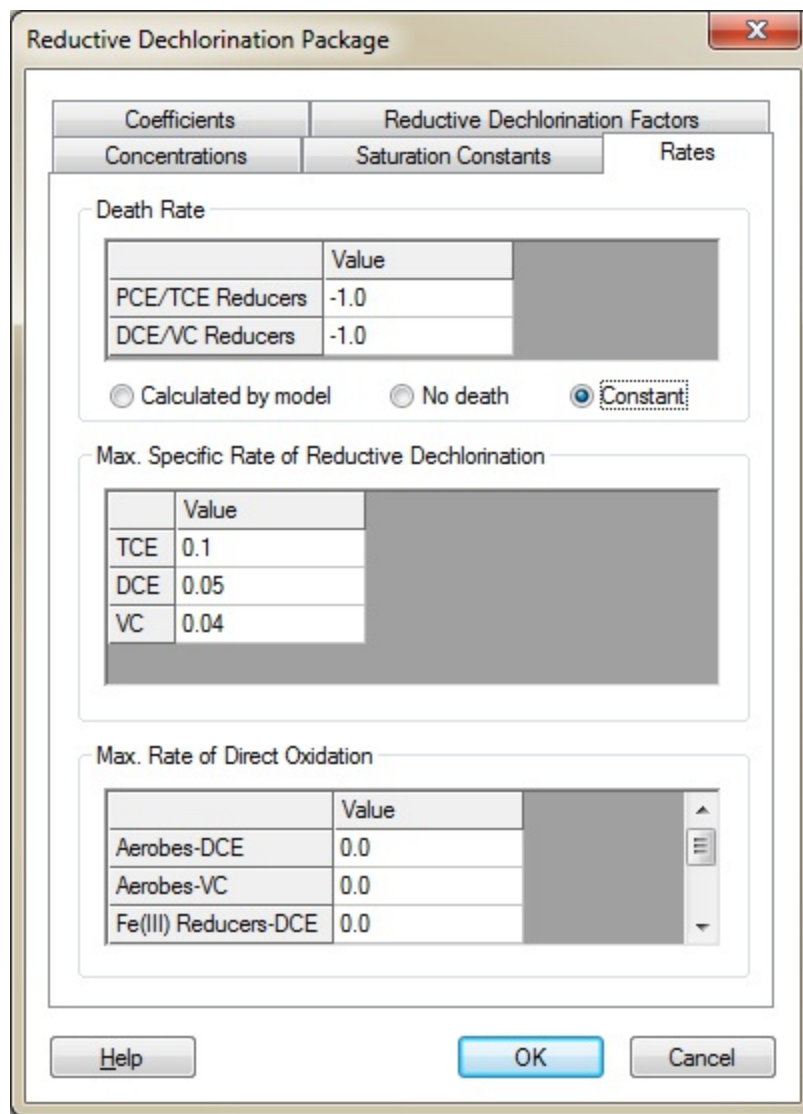

The SEAM3D Reductive Dechlorination Package showing the Rates tab

- Death Rate
 - Calculated by model
 - No death
 - Constant
- Maximum Specific Rate of Reductive Dechlorination
- Maximum Rate of Direct Oxidation

Coefficients

This tab allows setting *Yield Coefficients*, *Use Coefficient*, and *Methane Generation Coefficient* values.

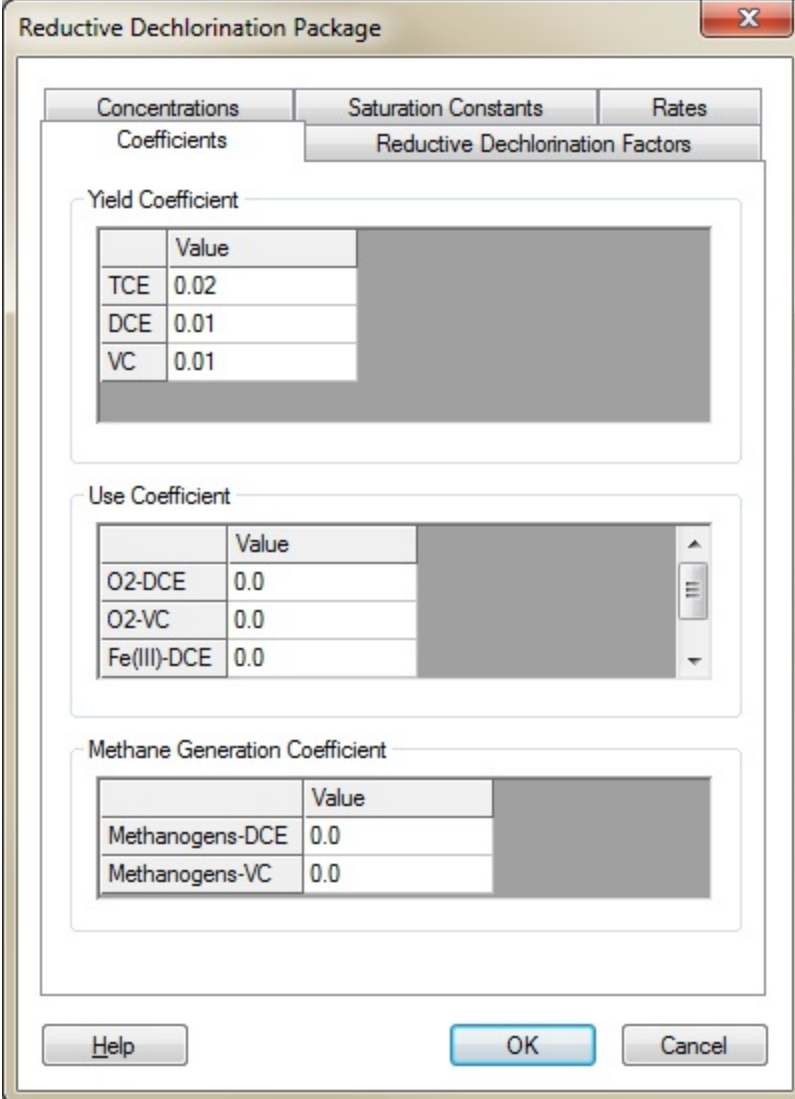

The screenshot shows the 'Reductive Dechlorination Package' window with the 'Coefficients' tab selected. The window is divided into three sections, each with a table of values.

Yield Coefficient

	Value
TCE	0.02
DCE	0.01
VC	0.01

Use Coefficient

	Value
O2-DCE	0.0
O2-VC	0.0
Fe(III)-DCE	0.0

Methane Generation Coefficient

	Value
Methanogens-DCE	0.0
Methanogens-VC	0.0

Buttons at the bottom: Help, OK, Cancel.

The SEAM3D Reductive Dechlorination Package showing the Coefficients tab

Reductive Dechlorination Factors

This tab allows setting values for *Chlorinated Ethene Inhibition Terms* and *Chlorinated Ethene Stoichiometric Factors*.

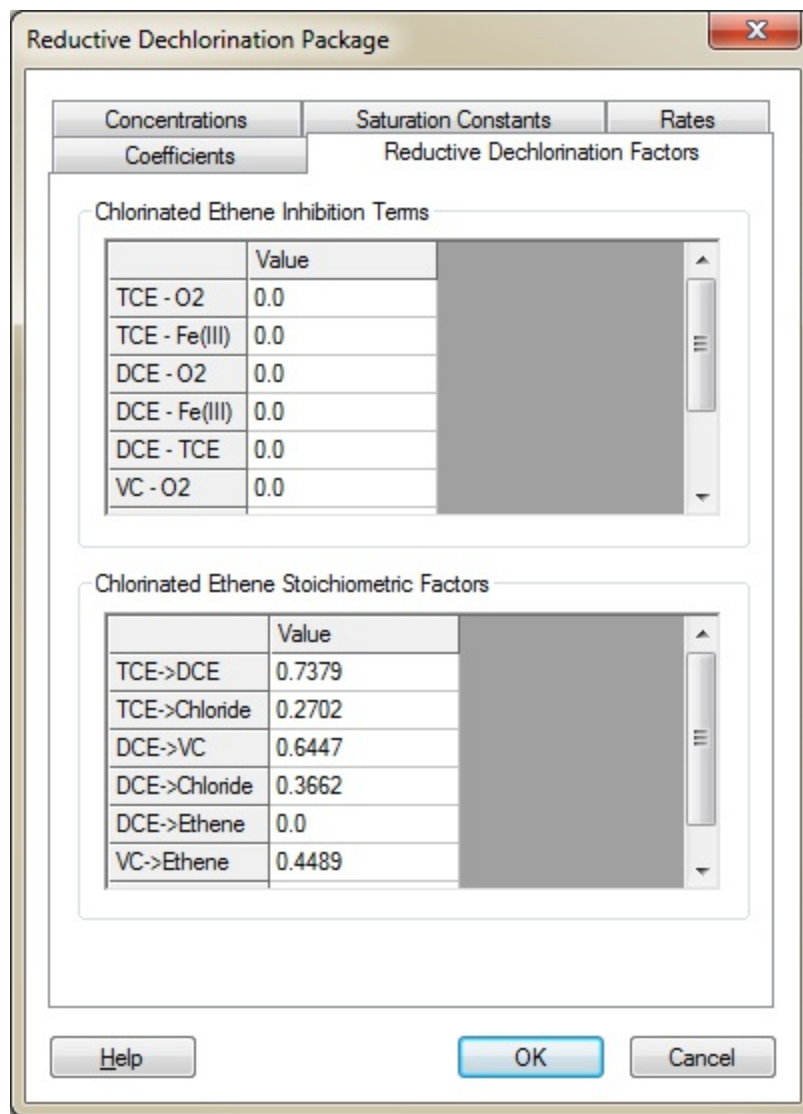

The SEAM3D Reductive Dechlorination Package showing the Reductive Dechlorination Factors tab

NAPL Dissolution Package

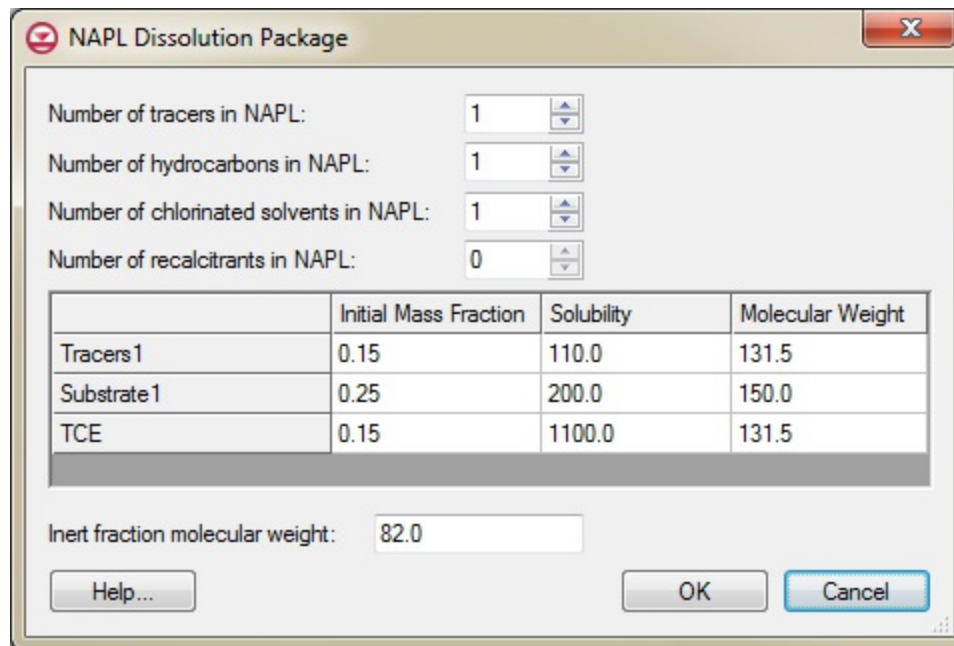

The NAPL Dissolution Package dialog

The [SEAM3D](#) model can account for the dissolution of compounds from non-aqueous phase liquids (NAPLs). The *NAPL Dissolution Package* allows simulation of the dissolution of electron donors (e.g., hydrocarbon contaminants) and chlorinated ethenes (PCE, TCE and/or DCE) from light and dense NAPLs into the aqueous phase.

The *NAPL Dissolution Package* dialog is reached through the *SEAM3D* | **NAPL Dissolution Package** command. The dialog has the following options:

- *Number of tracers in NAPL* (NTDIS)
- *Number of hydrocarbons in NAPL* (NHDIS)
- *Number of chlorinated solvents in NAPL* (NCDIS)
- *Number of recalcitrants in NAPL* (NRDIS)
- Compound variables
 - *Initial Mass Fraction*

- *Solubility*
- *Molecular Weight*
- *Inert fraction molecular weight*

6.13. SEAWAT

SEAWAT

SEAWAT is a three dimensional variable density groundwater flow and transport model developed by the USGS based on [MODFLOW](#) and [MT3DMS](#). SEAWAT v4 is based on MODFLOW 2000 and MT3DMS 5.2. SEAWAT includes two additional packages: Variable-Density Flow (VDF) and Viscosity (VSC). A complete description of SEAWAT is beyond the scope of this reference manual. It is assumed that the reader has a basic knowledge of SEAWAT and has read the SEAWAT documentation.

GMS supports SEAWAT as a pre- and post-processor. The interface to SEAWAT relies on the interface to MODFLOW and MT3DMS. The input data for SEAWAT is generated by GMS and saved to a set of files including a MODFLOW model, an MT3D model if transport is used, and a SEAWAT model pointing to the MODFLOW and MT3D model's package files. These files are then read by SEAWAT and executed. SEAWAT uses the MODFLOW and MT3D interfaces for boundary condition display and for post-processing which explains why many of the output files are saved as MODFLOW or MT3DMS files as shown in the *Output Files* table below.

The SEAWAT model can be added to a [paid edition](#) of GMS.

SEAWAT Files

Below are tables of some of the available input and output files for SEAWAT.

- For more information on these files see their respective MODFLOW, MT3DMS, and SEAWAT manuals

Input Files

Name	Description
SWN	SEAWAT Name Control File
VDF	SEAWAT Variable-Density Flow Process Input File
VSC	SEAWAT Viscosity Package Input File
GLO	MODFLOW Global Listing File
OUT	MODFLOW Output File
HED	MODFLOW HDF5 Head File
CCF	MODFLOW Cell-to-Cell Flow File
LMT	MODFLOW Link-MT3DMS Package
OBS	MODFLOW Main Observation Process input file
CHOB	MODFLOW Constant-Head Flow Observation Input File
ASP	MODFLOW Advanced Spacial Parameterization File
DIS	MODFLOW Discretization File
BA6	MODFLOW Basic Package
LPF	MODFLOW Layer Property Flow Package
OC	MODFLOW Process Output Control Option
RCH	MODFLOW Recharge Package
WEL	MODFLOW Process Well Package
CHD	MODFLOW Time-Variant Specified-Head Package
PCG	MODFLOW Preconditioned Conjugate-Gradient Package
BTN	MT3DMS Basic Transport Package
ADV	MT3DMS Advection Package
SSM	MT3DMS Sink/Source Mixing Package
GCG	MT3DMS Generalized Conjugate-Gradient Solver Package

Output Files

Name	Description
CBB	SEAWAT Binary Cell-By-Cell Flow File
HDS	SEAWAT Head File
LIST	SEAWAT List File
GLO	SEAWAT Global Listing File
_W	MODFLOW Weighted Residuals Data Exchange File
_WW	MODFLOW Weighted Equivalents & Weighted Observation
_WS	MODFLOW Weighted Residuals and Simulated Equivalents
_R	MODFLOW Unweighted Residuals Data Exchange File
_OS	MODFLOW Observed Values and Simulated Equivalents File
_B	MODFLOW Data Exchange File
_NM	MODFLOW Weighted Residuals and Probability Plotting file
OUT	MODFLOW Output File
CCF	MODFLOW Cell-to-Cell Flow File
GLO	MODFLOW Global Listing File
HED	MODFLOW HDF5 Head File
UCN	MT3DMS Unformatted Concentration File
CNF	MT3DMS Spatial Configuration File
P00	Unsuccessful Termination Error File

Importing a SEAWAT Simulation

An existing SEAWAT v4 model can be imported into GMS by opening the name file which

must have a ".nam" extension. Upon opening the name file, GMS uses the name file to determine if the simulation is MODFLOW-2000, MODFLOW-2005, or a SEAWAT simulation based on the packages included.

Once the import is complete, if the model includes transport packages or the VDF or VSC packages then a SEAWAT model is automatically created inside GMS.

If the model only includes MODFLOW packages, then the SEAWAT model needs to be created by enabling the SEAWAT model interface by selecting *SEAWAT* in the *Model Interfaces* dialog available under the *Edit* menu, and then selecting **New Simulation** under the *SEAWAT* menu.

SEAWAT Links

- [Building a SEAWAT Model](#)
- [SEAWAT Global Options Dialog](#)
- [SEAWAT Packages](#)
- [MODFLOW with HDF5](#)

SEAWAT External Links

- [SEAWAT website](#)

Building a SEAWAT Model

Grid Approach

Although it is not always the most efficient approach, a SEAWAT simulation can be completely defined using only the tools in the 3D Grid module. To build a SEAWAT model with this approach, first create a MODFLOW model using the [grid approach](#). If using transport, an MT3DMS model is then created, and then a [SEAWAT](#) model is created. For each of the three models the properties and concentrations at sources/sinks are [assigned directly to the cells](#). Any SEAWAT [MODFLOW AUX variables](#) are assigned using the MODFLOW package dialogs. SEAWAT specific packages can be set using the [VDF](#) or [VSC package](#) dialogs.

Conceptual Model Approach

To create a SEAWAT using a conceptual model:

1. Construct a [MODFLOW conceptual model](#), [create a grid](#), and [convert the conceptual model data](#) to the MODFLOW data defined at the grid cells.
2. Run the MODFLOW simulation to make sure it is working properly.
3. If the simulation includes transport, return to the [Map module](#). Edit the properties of the conceptual model to include transport. Assign concentrations to the sources/sinks in the conceptual model where necessary. Also define [polygonal zones](#) describing layer data including porosity, longitudinal dispersivity, sorption constants, rate constants, and bulk density.
4. Select the *Feature Objects* | **Map** → **MT3DMS** command to automatically assign the MT3DMS data to the appropriate cells in the grid.
5. Enable SEAWAT in the [Model Interfaces](#) dialog and [create a SEAWAT simulation](#).
6. Edit the MODFLOW AUX variables, VDF, and VSC packages if necessary.
7. Use the SEAWAT model checker to check the simulation for any errors or warnings.

See also

- [Building MODFLOW Model](#)
- [Building an MT3DMS Simulation](#)

SEAWAT Global Options Dialog

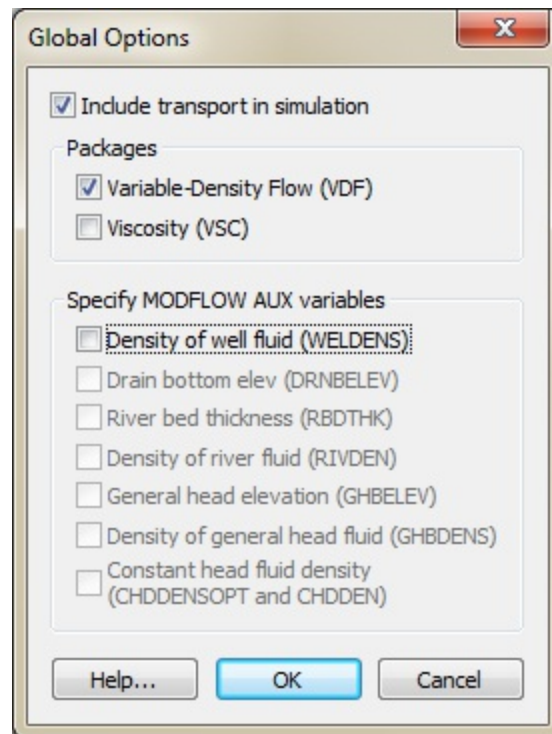

Example of the SEAWAT Global Options dialog

The *Global Options* dialog is used to setup a new SEAWAT model or to edit the current options for an existing model. To set up a new SEAWAT model select **Edit | Model Interfaces...** menu command and turn on the SEAWAT model interface. Next select **SEAWAT | New** menu item to create the SEAWAT model.

In the *Global Options* dialog, options are provided to modify the use of transport in the simulation, to turn on and off the **Variable-Density Flow (VDF)** and **Viscosity (VSC)** packages, and to enable or disable the SEAWAT MODFLOW AUX variables used by SEAWAT.

The Variable-Density Flow package will use the MODFLOW methodology to solve the variable-density ground-water flow equation. The Viscosity package will include the effects of fluid viscosity on the internodal conductance terms.

The MODFLOW AUX variables include:

- WELDENS – Density of well fluid (WEL package).
- DRNBELEV – Drain bottom elevation (DRN package).
- RBDTHK – River bed thickness (RIV package).
- RIVDEN – Density of river fluid (RIV package).
- GHBELEV – General head elevation (GHB package).
- GHBDENS – Density of general head fluid (GHB package).
- CHDDENSOPT and CHDDEN – Constant head fluid density (CHD package).

These AUX variables can be edited in the associated *MODFLOW Package* dialog or in the *MODFLOW Sources/Sinks* dialog.

SEAWAT Packages

SEAWAT specific packages include the Variable-Density Flow (VDF) and Viscosity (VSC) packages. The package dialogs for both packages are available under the *SEAWAT* menu. For the package menu items to be available, the packages must first be enabled from the [SEAWAT Global Options dialog](#). For a detailed description of the VDF and VSC input options, please refer to the [SEAWAT manual](#).

VDF Package

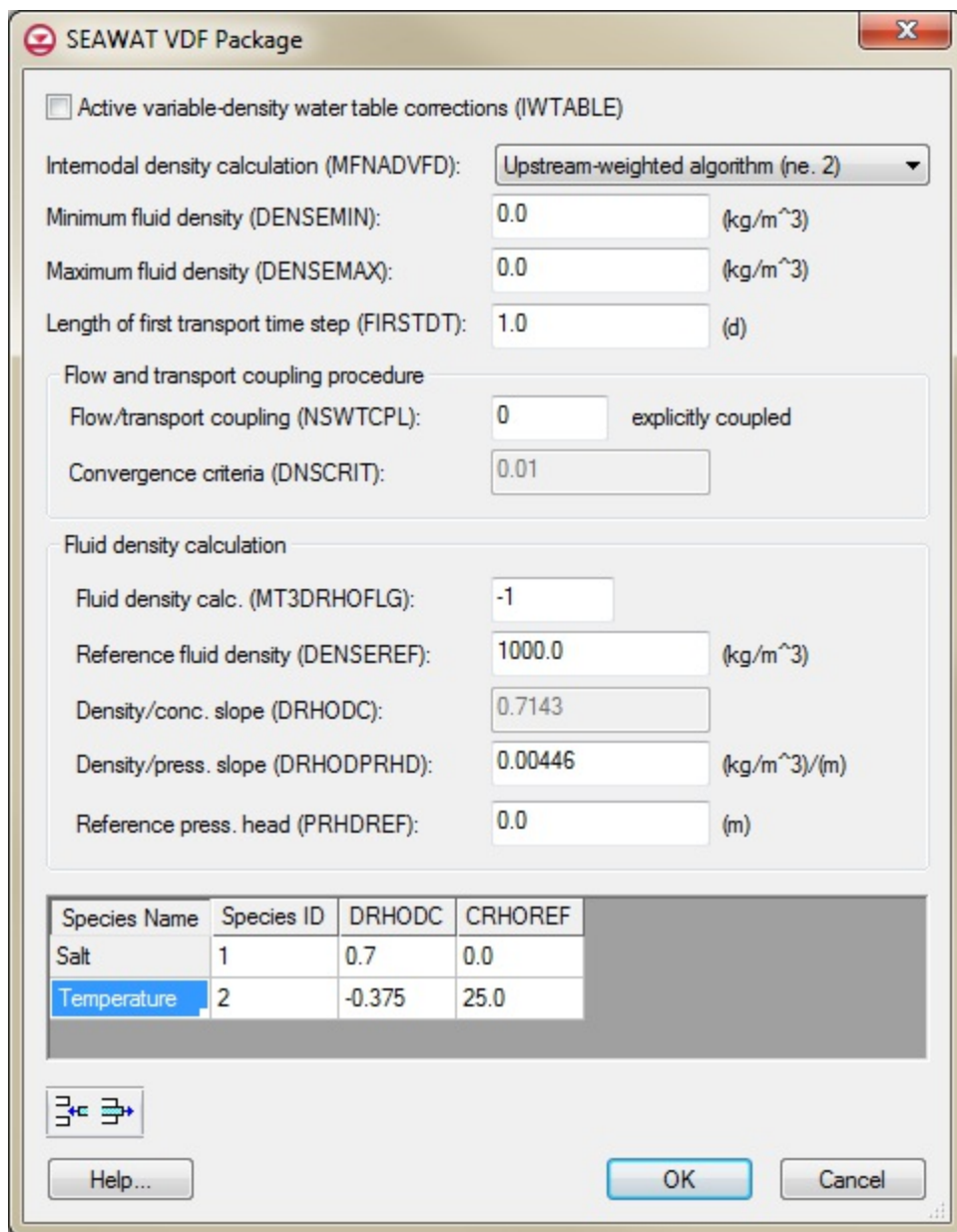

The SEAWAT VDF Package dialog



The VDF package can be used in a SEAWAT simulation to model the affects of concentration on fluid density. The input values available in the VDF package include:

- *Active variable-density water table corrections (IWTABLE)* – A flag used to activate the variable-density water-table corrections when turned on.
- *Internodal density calculation method (MFNADVFD)* – A flag that determines the method for calculating the internodal density values used to conserve fluid mass. Options include:

- Central-in-space algorithm (eq. 2)
- Upstream-weighted algorithm (ne. 2)
- *Minimum fluid density (DENSEMIN)* – If the resulting density value calculated with the equation of state is less than this value, the density value is set to the entered value.
- *Maximum fluid density (DENSEMAX)* – If the resulting density value calculated with the equation of state is greater than this value, the density value is set to the entered value.
- *Length of first transport time step (FIRSTDT)* – Used to start the simulation if both the IMT Process is active and transport time steps are calculated as a function of the user-specified Courant number.
- *Flow/transport coupling (NSWTCPL)* – A flag used to determine the flow and transport coupling procedure. If 0 or 1, flow and transport will be explicitly coupled using a one-timestep lag. If greater than 1 then will be the maximum number of non-linear coupling iterations for the flow and transport solutions. If -1 the flow solution will be recalculated for the first transport step of the simulation, or the last transport step of the MODFLOW time step, or the maximum density change at a cell is greater than DNSCRIT.
- *Convergence criteria (DNSCRIT)* – . Value for the maximum change in fluid density.
- *Fluid density calculation (MT3DRHOFLG)* – The MT3DMS species number that will be used in the equation of state to compute fluid density. When equal to zero, the fluid density for each grid cell can be entered in the table at the bottom of the dialog. For INDENSE enter -1 to use values from previous stress period, 0 to use DENSEREF, and 1 to enter values for DENSE column. When equal to -1, the fluid density will be calculated using one or more species entered in the table at the bottom of the dialog using species ID, DRHODC, and CRHOREF. Rows can be entered into the table with the tool bar below the table. When greater than or equal to 1 density is calculated using the corresponding species number.
- *Reference fluid density (DENSEREF)* – The fluid density at the reference concentration, temperature, and pressure.

- *Density/concentration slope (DRHODC)* – The slope of the linear equation of state that relates fluid density to solute concentration.
- *Density/pressure slope (DRHODPRHD)* – The slope of the linear equation of state that relates fluid density to the height of the pressure head.
- *Reference pressure head (PRHDREF)* – The reference pressure head. This value should normally be set to zero.

Species Table

This table allows adding or removing each solute species by using the **Insert Row**  or **Delete Row**  buttons. Options for the VDF package include:

- *Species Name* – The name will be based on the assigned *Species ID*.
- *Species ID* – The identity number of the species as assigned in the [MT3D model](#).
- *DRHODC* – Density/concentration slope.
- *CRHOREF* – The reference concentration for species.

VSC Package

SEAWAT VSC Package

Minimum viscosity (VISCMIN): 0.0 (kg/(m*d))

Maximum viscosity (VISCMAX): 0.0 (kg/(m*d))

Fluid viscosity calc. (MT3DMUFLG): -1

Reference viscosity (VISCREF): 0.0008904 (kg/(m*d))

Viscosity/conc. slope (DMUDC): 0.0 (kg/(m*d))

Reference conc. (CMUREF): 0.0 (kg/m³)/(kg/m³)

Temp. affect on visc. (MUTEMPOPT): (1) eq. 18 A1*A2^[A3/(T+A4)]

Use default values for A1 - A5

Temp. species id (MTMUTEMPSPEC): 2 Temperature

"A1" in eq. 18-20 (AMUCOEFF-1): 0.00002394

"A2" in eq. 18-20 (AMUCOEFF-2): 10.0

"A3" in eq. 18-20 (AMUCOEFF-3): 248.37

"A4" in eq. 18-20 (AMUCOEFF-4): 133.15

"A5" in eq. 18-20 (AMUCOEFF-5): 0.0

Species Name	Species ID	DMUDC	CMUREF
Salt	1	1.923e-006	0.0

Help... OK Cancel

The SEAWAT VSC Package dialog



The VSC package can be used in a SEAWAT simulation to model the affects of concentration on fluid viscosity. Using the Viscosity package requires using the VDF package and the LPF package in MODFLOW. The input values available in the VSC package include:

- *Minimum viscosity (VISCMIN)* – If the resulting viscosity value calculated with the equation is less than this value, the viscosity value is set to the entered value.
- *Maximum viscosity (VISCMAX)* – If the resulting viscosity value calculated with the

equation is greater than this value, the viscosity value is set to the entered value.

- *Fluid viscosity calculation (MT3DMUFLG)* – When equal to zero, the fluid viscosity for each grid cell can be entered in the table at the bottom of the dialog. For INVISC enter -1 to use values from previous stress period, 0 to use VISCREF, and 1 to enter values for VISC column. When equal to -1, the fluid density will be calculated using one or more species entered in the table at the bottom of the dialog using species ID, DMUDC, and CMUREF. Rows can be entered into the table with the tools bar below the table. When greater than or equal to 1 viscosity is calculated using the corresponding species number.
- *Reference viscosity (VISCREF)* – The fluid viscosity at the reference concentration and reference temperature.
- *Viscosity/concentration slope (DMUDC)* – The slope of the linear equation that relates fluid viscosity to solute concentration.
- *Reference concentration (CMUREF)* – The reference concentration for species.
- *Temperature effect on viscosity (MUTEMPOPT)* – A flag that specifies the option for including the effect of temperature on fluid viscosity. It has the following options:
 - (0) No temperature effect or linear relation
 - (1) equation 18 $A_1 * A_2^{A_3/(T+A_4)}$
 - (2) equation 19 $A_1 * [A_2 + A_3(T + A_4)]_5^A$
 - (3) equation 20 $A_1 * T^{A_2}$
- *Use default values for A1–A5* – When on, disables edit fields for AMUCOEFF as the default values will be used.
- *Temperature species ID (MTMUTEMPSPEC)* – The MT3DMS species number that corresponds to temperature.
- *AMUCOEFF* – Coefficients for equation 18-20 in SEAWAT 4 documentation.

Species Table

This table allows adding or removing each solute species by using the **Insert Row**  or **Delete Row**  buttons. Options for the VSC package include:

- *Species Name* – The name will be based on the assigned *Species ID*.
- *Species ID* – The identity number of the species as assigned in the [MT3D model](#).
- *DMUDC* – Viscosity/concentration slope.
- *CMUREF* – Reference concentration.

SEAWAT Commands

The *SEAWAT* menu has the following commands:

New Simulation...

This command will create a new SEAWAT simulation. If another SEAWAT simulation has already been created or loaded into GMS, the older simulation will be deleted.

Delete Simulation...

This command will remove the SEAWAT simulation that has been created or loaded into GMS.

Check Simulation...

Starts the *Model Checker* dialog.

Run SEAWAT...

Generates the simulation solution.

Read Solution...

Allows opening a SEAWAT solution file.

Global Options...

Opens the *SEAWAT Global Options* dialog. See [SEAWAT Global Options Dialog](#) for more information.

VDF Package...

Opens the *SEAWAT VDF Package* dialog. See [VDF Package](#) for more information.

VSC Package...

Opens the *SEAWAT VSC Package* dialog. See [VSC Package](#) for more information.

Related Topics

- [SEAWAT](#)

6.14. SEEP2D

SEEP2D

SEEP2D is a two-dimensional steady state finite element groundwater model developed by Fred Tracy of the [Engineer Research and Development Center](#). Both saturated and unsaturated flow is simulated. SEEP2D is designed to be used on profile models (XZ models) such as cross-sections of earth dams or levees.

A variety of options are provided in GMS for displaying SEEP2D results. Contours of total head (equipotential lines) and flow vectors can be plotted. An option is also available for computing flow potential values at the nodes. These values can be used to plot flow lines. Together with the equipotential lines (lines of constant total head), the flow lines can be used to plot a flow net. The phreatic surface can also be displayed.

A more complete description of the SEEP2D model, including a discussion of boundary conditions and guidelines for model conceptualization is contained in the SEEP2D Primer. The SEEP2D Primer should be reviewed before consulting this help file. The user is also encouraged to complete the SEEP2D tutorials.

Portions of a SEEP2D model can be imported from [GeoStudio](#) files.

The SEEP2D model can be added to a [paid edition](#) of GMS.

Building a SEEP2D Simulation

Total Flowrate = 4492.829 (ft³/d)/(ft)

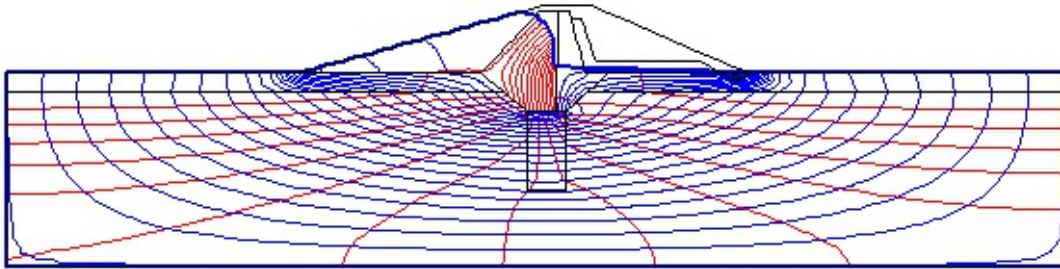

Sample flow net from SEEP2D

Creating a SEEP2D model in GMS requires using the [GMS 2D program mode](#). For a typical application, the following steps are used to perform a SEEP2D simulation using GMS:

1. **Generate a 2D mesh** – The first step in setting up a SEEP2D simulation is to construct a 2D finite element mesh. This can be accomplished using the *Feature Objects | Map* → **2D Mesh** command in the [Map module](#). SEEP2D only supports meshes composed entirely of linear elements (three node triangles and four node quadrilaterals). The mesh should not contain quadratic elements (six node triangles and eight node quadrilaterals).
2. **Select the analysis options** – The analysis options are used to set up the type of problem being modeled and to defined constants that are used by SEEP2D when calculating the solution. This is done in the *SEEP2D Analysis Options* dialog. ([See below.](#))
3. **Assign the material properties** – Each element in the 2D mesh is assigned a material ID. The material properties are assigned to each element using these IDs and a list of material properties.
4. **Assign the boundary conditions** (either with a conceptual model or with the 2D mesh tools) – Two general types of boundary conditions can be defined for SEEP2D simulations: nodal boundary conditions and flux boundary conditions. (See [SEEP2D Boundary Conditions](#))

5. Run the **Model Checker**.
6. **Save the simulation**
7. **Run the simulation**
8. **Display the results** – Before reading in the solution file for post-processing in GMS, it is often useful to examine the text output listing file. The output file can also be viewed by simply double-clicking on the *.out file found in the **SEEP2D solution** folder in the **Project Explorer**. Also, any text file can be viewed by selecting the **Edit File** command in the *File* menu. The File Browser appears and the selected file is opened in a text editor. Once the solution is imported to GMS, a variety of options are available for displaying the solution. The total head and pressure head datasets can be contoured. Velocity vectors corresponding to Darcy velocity can be plotted. If the *Compute flow lines* option was selected, a complete flow net may be plotted by displaying contours of total head (equipotential lines) and turning on the *Flow lines* option in the *SEEP2D Display Options* dialog.

SEEP2D Boundary Conditions

Two general types of boundary conditions can be defined for SEEP2D simulations: nodal boundary conditions and flux boundary conditions. The type or value assigned to a previously defined boundary condition can be edited by selecting the node or node string and selecting either the **Node BC** or **Flux BC** commands. A boundary condition can be deleted by selecting the boundary condition using either the **Select Node** or **Select Node String** tools and selecting the **Delete BC** command in the *SEEP2D* menu.

Nodal Boundary Conditions

The most common type of SEEP2D boundary conditions is nodal boundary conditions. Nodal boundary conditions are assigned by selecting the nodes and selecting the **Node BC** command in the *SEEP2D* menu. When selecting the nodes, either the **Select Node** tool or the **Select Node String** tool may be used. The **Node BC** command brings up the *Node BC* dialog. Three types of nodal boundary conditions can be assigned: head, exit face, and flow rate.

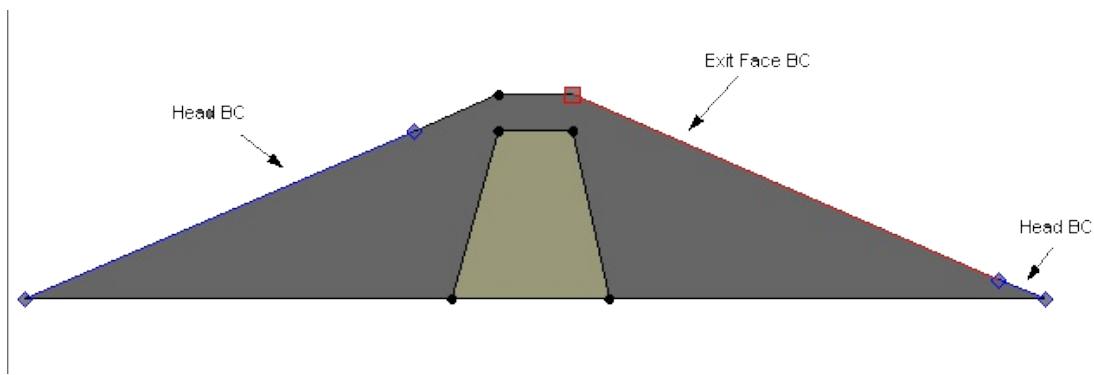

Sample SEEP2D problem showing boundary conditions

- **Head BC** – Specified head boundary conditions represent boundaries where the head is known. They typically are found where water is ponding or at the boundary of a region where the water table is known to remain constant. Since the head along such boundaries cannot change, they represent regions of the model where flow enters or exits the system (flow lines are always orthogonal to constant head boundaries).
- **Exit Face BC** – Exit face boundary conditions are used when modeling unconfined flow problems and should be placed along the face where the free surface is likely to exit the model. If the head at a node with an exit face bc becomes greater than the node elevation during the iteration process, the head at the node is fixed at the nodal elevation and the node acts as a specified head boundary. Thus, water is allowed to exit the model at that node.
- **Flow Rate BC** – Flow rate boundary conditions are used to specify nodes at which a certain flow rate is known to exist. They are used primarily when modeling wells and the flow specified represents the pumping rate. Negative values represent extraction of fluid from the system whereas positive values represent injection.



The SEEP2D Node BC dialog.

Flux Boundary Conditions

Flux boundary conditions are used to specify a known flux rate [L/T] along a sequence of element edges on the perimeter of the mesh. They are often used to simulate infiltration. Flux into the system is positive and flux out of the system is negative.

Flux BC are assigned by selecting a sequence of nodes along the mesh boundary using the **Select Node String** tool and selecting the **Flux BC** command in the *SEEP2D* menu. This command brings up a simple prompt for the flow rate.

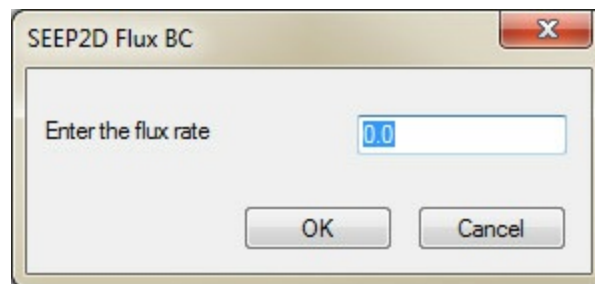

The SEEP2D Flux BC dialog.

SEEP2D Materials

The material properties specific to SEEP2D are entered using the **Material** command in the *Edit* menu. This command brings up the *SEEP2D* tab of the *Materials* dialog.

The options in the dialog are as follows:

- *List of Materials* – The currently defined materials are listed at the top of the dialog. The values for a material are entered by selecting the material and editing the values in the lower part of the dialog.
- *Soil Coefficients* – The hydraulic conductivity in the two major principal directions and the angle from the x-axis to the major principal axis are entered in the Soil Coefficients section. These hydraulic conductivity values represent the hydraulic conductivity for saturated conditions.
- *Van Genuchten Parameters* – If the *Van Genuchten Saturated/Unsaturated* option has been selected in the *SEEP2D Analysis Options* dialog, the Van Genuchten alpha and n-value numbers must be defined.
- *Linear Front Parameters* – If the Saturated/Unsaturated with *Linear Front* option has been selected in the *SEEP2D Analysis Options* dialog, the minimum pressure head (h_0) and minimum relative conductivity (k_{ro}) values must be defined.

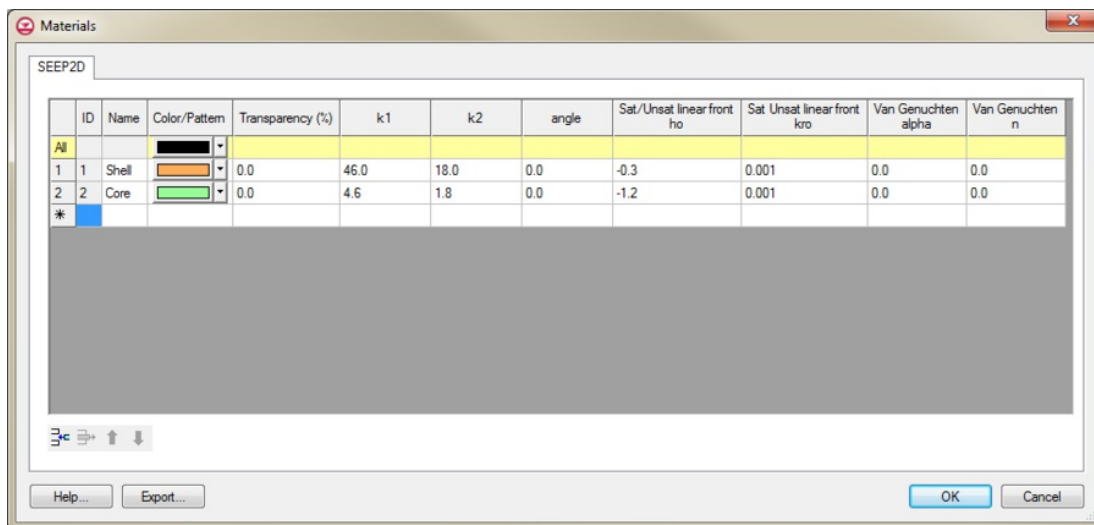

The SEEP2D tab of the Materials dialog

SEEP2D Analysis Options

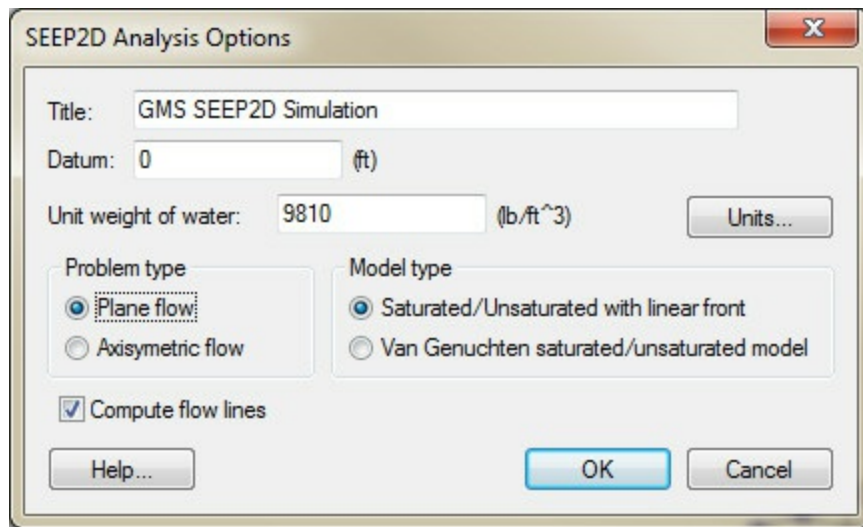

SEEP2D Analysis Options dialog

Options for the SEEP2D model can be set in the *SEEP2D Analysis Options* dialog. This dialog is accessed through the *SEEP2D* menu.

The items in the dialog are as follows:

- *Title* – A descriptive title can be entered for the simulation. This title is used in the header of the SEEP2D input and output files. It can also be displayed at the top of the Graphics Window in GMS by turning on the *Title* option in the [SEEP2D Display Options](#) dialog.
- *Datum* – By default, the datum of the model is at zero, but it can be specified to any convenient value, such as the value corresponding to the base or lowest y coordinate of the model.
- *Unit Weight of Water* – The unit weight of water must be entered. SEEP2D uses this value to compute pore pressures. The weight and length units defined in this value should be consistent with the units used elsewhere in the model.
- *Units* – The **Units** button brings up the [Units](#) dialog. This dialog is used to enter the units for length, time, concentration, etc. for the simulation. GMS uses the selected unit options to display the appropriate units next to each input edit field in the other SEEP2D dialogs.
- *Problem Type* – The problem type must be specified either as plane flow or

axisymmetric flow. The *Axisymmetric* option should be selected for models corresponding to flow to a single well as described in the SEEP2D Primer. All other models should use the *Plane flow* option.

- *Flow Lines* – If the *Compute flow lines* option is turned on, once the head solution is computed, SEEP2D will reverse the boundary conditions and compute flow potential values at the nodes. These values can be contoured by GMS using the *Flow lines* option in the *SEEP2D Display Options* dialog.
- *Model Type* – The hydraulic conductivity in the unsaturated zone is modified (reduced) using either the linear frontal method or the Van Genuchten method. The equations used by both methods are described in more detail in the SEEP2D Primer.



Reading the **SEEP2D Solution**

The solution can be imported into GMS using the **Read Solution** command in the *SEEP2D* menu. Also at the end of a SEEP2D run the solution is automatically imported to GMS. The solution files are organized in a SEEP2D solution folder in the [Project Explorer](#).

SEEP2D Files

See the main page about SEEP2D files at [SEEP2D Files](#).

SEEP2D Display Options

The properties of all [SEEP2D data](#) that GMS displays on the screen can be controlled through the SEEP2D tab of the [Display Options](#) dialog. This dialog is opened by right-clicking on the 2D Mesh Data  entry in the [Project Explorer](#), selecting the **Display Options** command, and then selecting the SEEP2D tab. This tab is only visible when there is a SEEP2D simulation. It can also be accessed from the [Display](#) menu, the [SEEP2D](#) menu, or the **Display Options**  macro. The following table describes the display options available for the SEEP model.

Display Option	Description
Head BC	The <i>Head BC</i> , <i>Exit face BC</i> , <i>Flux rate BC</i> , and <i>Flux BC</i> items can be used to turn on the display of a symbol for each of the boundary condition types. The color and type of symbol can be edited by clicking on the button to the left of each item.
Exit face BC	
Flow rate BC	
Flux BC	
BC values	If the <i>BC values</i> option is selected, the numerical value of each boundary condition (head, flux rate, etc.) is displayed next to the boundary condition. The font used to display the values can be editing by clicking on the button to the left of the item.
Flow lines	If the <i>Compute flow lines</i> option is selected the <i>SEEP2D Analysis Options</i> dialog prior to saving and running the model, SEEP2D performs the computations in two steps. In the first step, SEEP2D solves for the heads. In the second step, the head solution is used to "reverse" the boundary conditions and a second solution is found. This solution represents "flow potential" values. When the solution is read back into GMS, these flow values can be contoured to generate a plot of flow lines. When superimposed on contours of total head (equipotential lines) a complete flow net can be displayed. (see Note)
Title	If the <i>Title</i> option is selected, the problem title specified in the <i>Analysis Options</i> dialog will be displayed at the top of the Graphics Window.
Total flow rate	If the <i>Total flow rate</i> option is selected and if a solution is in memory, the total flow rate through the model will be displayed at the top of the Graphics Window, just below the title.
Phreatic surface	If the <i>Phreatic Surface</i> option is selected and if a solution is in memory, the phreatic surface will be displayed on the mesh. The color and type of line can be edited by clicking on the button to the left of the item.
Check All	By clicking this button, all of the display options are turned on.
Check None	By clicking this button, all of the display options are turned off.

Note: When contouring the flow values, GMS must determine a contour interval that will result in the proper number of flow channels. The number of flow channels is computed by solving for numflow in the following equation:

$$q = k_{\text{equiv}} \frac{\text{numflow}}{\text{numequipotential}} \Delta H$$

The kequiv value is solved for using the k values for the base material specified using the combo box just below the Flow Lines option. The equivalent k is computed as follows:

$$k_{\text{equiv}} = \sqrt{k_1 * k_2}$$

For problems with several material zones where each material is isotropic, the flow net cells in the base material will appear to be square, while the cells in the other material zones will be stretched. The amount of stretching is a function of the relative difference in k values between the material and the base material.

SEEP2D Solution

After a SEEP2D simulation is run in GMS, the solution to this simulation can be automatically loaded into GMS. The solution will appear in the [Project Explorer](#) under the "2D Mesh Data" folder in its own subfolder. The subfolder will appear with a lock image on it . The image means that the information in the solution folder is locked and cannot be edited from within GMS. The solution datasets in the solution can be contoured and viewed in GMS.

The potential datasets that may be part of a SEEP2D solution are listed below with a brief description.

- Total Head – The pressure head plus the elevation head (same as the head measured by a piezometer).
- Pressure Head – The water pressure divided by the unit weight of water.
- Pore Pressure – The hydrostatic pressure.
- Flowrate – The flow rate of water into (out of) the problem domain.
- Velocity – The discharge velocity is calculated by multiplying the gradient by hydraulic conductivity $[k \cdot i]$. This is a vector dataset and is accompanied by a scalar dataset called "velocity_Mag" that is the magnitude of the vector dataset.
- Gradient – The hydraulic gradient is calculated by dividing the difference in Total Head by distance $[(h_1 - h_2)/L]$. This is a vector dataset and is accompanied by a scalar dataset called "gradient_Mag" that is the magnitude of the vector dataset.
- Flowline – This dataset is used to create a flow net when the Total Head dataset is the active dataset.

All dataset values are calculated at every node in the mesh.

SEEP2D Commands

When the SEEP2D model is active, the *SEEP2D* menu becomes available. The menu has the following commands:

New Simulation...

This command will create a new SEEP2D simulation. The current SEEP2D simulation will be deleted.

Delete BC

Removes the selected boundary condition.

Delete Simulation...

Removes the selected simulation.

Check Simulation...

Starts the *Model Checker* dialog.

Run SEEP2D...

Generates the simulation solution.

Read Solution...

This command will open a SEEP2D (*.sps) solution file.

Analysis Options...

Opens the *SEEP2D Analysis Options* dialog.

Display Options...

Opens the *Display Options* dialog. See [SEEP2D Display Options](#) for more information.

Node BC...

Opens the *Node BC* dialog. See [Nodal Boundary Conditions](#) for more information.

Flux BC...

Opens the *SEEP2D Flux BC* dialog. This dialog allows entering a new flux rate. See [Flux Boundary Conditions](#) for more information.

Export to Levee Analyst DB...

Starts the *Export to Levee Analyst Database Wizard*

Related Topics

- [SEEP2D](#)

6.15. T-PROGS

T-PROGS

GMS includes an interface to the T-PROGS (Transition PRObability GeoStatistical) software developed by Steven Carle. The T-PROGS software is used to perform transition probability geostatistics on borehole data. The output of the T-PROGS software is a set of [N material sets](#) on a 3D grid. Each of the material sets is conditioned to the borehole data and the materials proportions and transitions between the boreholes following the trends observed in the borehole data. These material sets can be used for [stochastic simulations](#) with MODFLOW. A sample material set generated by the T-PROGS software is shown below. This software can also be used to generate multiple input datasets for the [HUF package](#).

The T-PROGS model can be added to a [paid edition](#) of GMS.

T-PROGS Interface

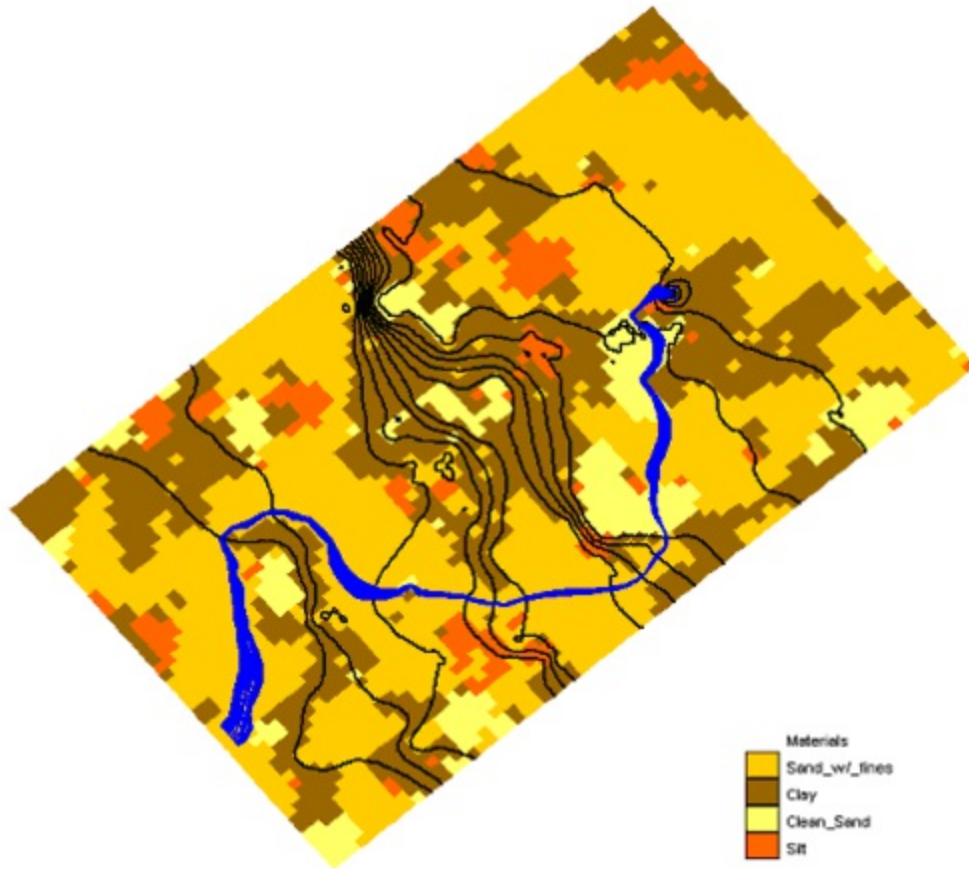

MODFLOW solution for a T-PROGS grid. Black lines are head contours and blue lines are pathlines for an extraction well.

Vertical Transition Probability

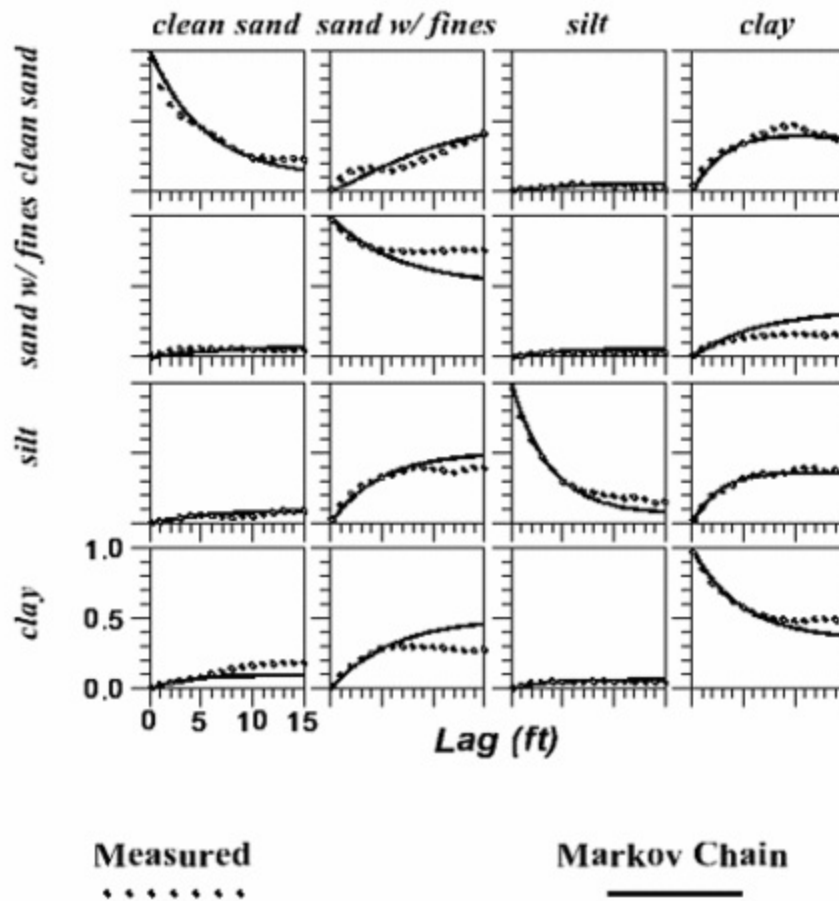

Observed transition probabilities (circles) and Markov chain model (solid lines) for a set of borehole data with four materials.

The T-PROGS software utilizes a transition probability-based geostatistical approach to model spatial variability by 3-D Markov Chains, set up indicator co-kriging equations, and formulate the objective function for simulated annealing. The transition probability approach has several advantages over traditional indicator kriging methods. First, the transition probability approach considers asymmetric juxtapositional tendencies, such as fining-upwards sequences. Second, the transition probability approach has a conceptual framework for incorporating geologic interpretations into the development of cross-correlated spatial variability. Furthermore, the transition probability approach does not exclusively rely on empirical curve fitting to develop the indicator (cross-) variogram model.

This is advantageous because geologic data are typically only adequate to develop a model of spatial variability in the vertical direction. The transition probability approach provides a conceptual framework to geologic insight into a simple and compact mathematical model, the Markov chain. This is accomplished by linking fundamental observable attributes—mean lengths, material proportions, anisotropy, and juxtapositioning – with Markov chain model parameters.

The first step in using T-PROGS is to import a set of borehole data. The borehole data are then passed to a utility within T-PROGS called GAMEAS that computes a set of [transition probability curves](#) as a function of lag distance for each category for a given sampling interval. A sample set of measured transition probability curves are shown by the dashed lines in the following figure.

Each curve represents the transition probability from material j to material k . The transition probability $t_{jk}(h)$ is defined by:

$$t_{jk}(\mathbf{h}) = \Pr\{k \text{ occurs at } \mathbf{x} + \mathbf{h} \mid j \text{ occurs at } \mathbf{x}\}$$

where x is a spatial location, h is the lag (separation vector), and j, k denote materials. Note that the curves on the diagonal represent auto-transition probabilities, and the curves on the off-diagonal represent cross-transition probabilities.

The next step in the analysis is to develop a Markov Chain model for the vertical direction that fits the observed vertical transition probability data. The Markov Chain curves are shown as solid lines in the preceding figure. Mathematically, a Markov chain model applied to one-dimensional categorical data in a direction Φ assumes a matrix exponential form:

$$T(h_\Phi) = \exp(R_\Phi h_\Phi)$$

where h denotes a lag in the direction Φ , and R_Φ denotes a transition rate matrix

$$R_\Phi = \begin{bmatrix} r_{11,\Phi} & \cdots & r_{1k,\Phi} \\ \vdots & \ddots & \vdots \\ r_{k1,\Phi} & \cdots & r_{kk,\Phi} \end{bmatrix}$$

with entries r_{jk} representing the rate of change from category j to category k (conditional to the presence of j) per unit length in the direction Φ . The transition rates are adjusted to ensure a good fit between the Markov Chain model and the observed transition probability data.

Once the Markov chain is developed for the z direction from the borehole data, a model of spatial variability must be developed for the x and y directions. Borehole data are typically not sufficiently dense in these directions. However, the [x and y-direction Markov chains](#) can be developed by assuming that the juxtapositional tendencies and the proportions observed in the vertical direction also hold true in the horizontal directions. The modeler then provides an estimate of the ratio of the mean lengths in the x and y directions relative to the z direction, and the transition rate matrices for the x and y directions can be formulated. The x, y, and z Markov chains are converted into a continuous 3D Markov chain using the MCMOD utility within T-PROGS.

In the final phase of setting up a transition probability analysis using T-PROGS, the modeler creates a grid, specifies the number of model instances (N), and launches the TSIM utility. The TSIM code uses the 3D Markov chain to formulate both indicator cokriging equations and an objective function for simulated annealing. It generates [stochastic simulations](#) using a combination of modified versions of the GSLIB codes SISIM and ANNEAL.

T-PROGS Materials

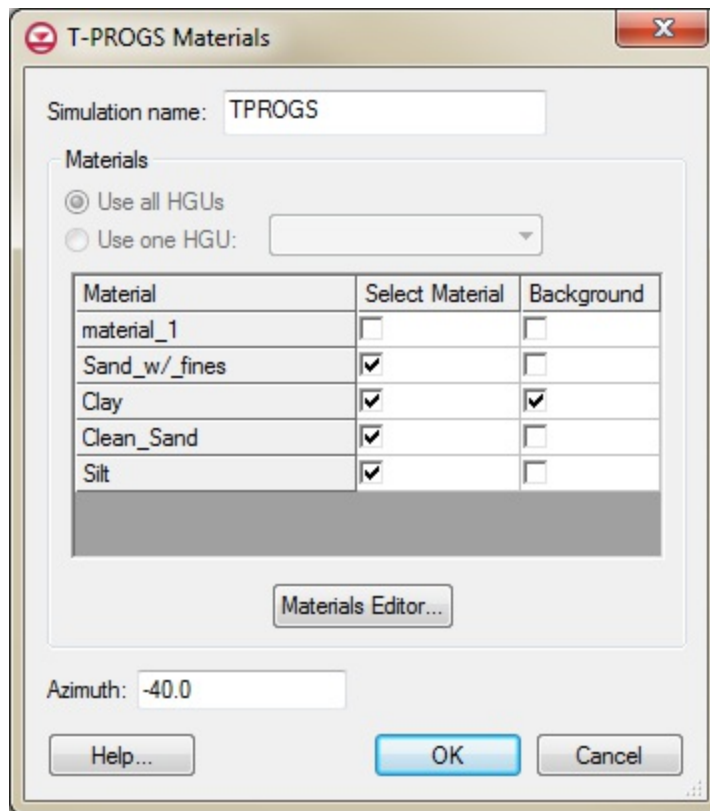

T-PROGS Materials dialog without borehole data.

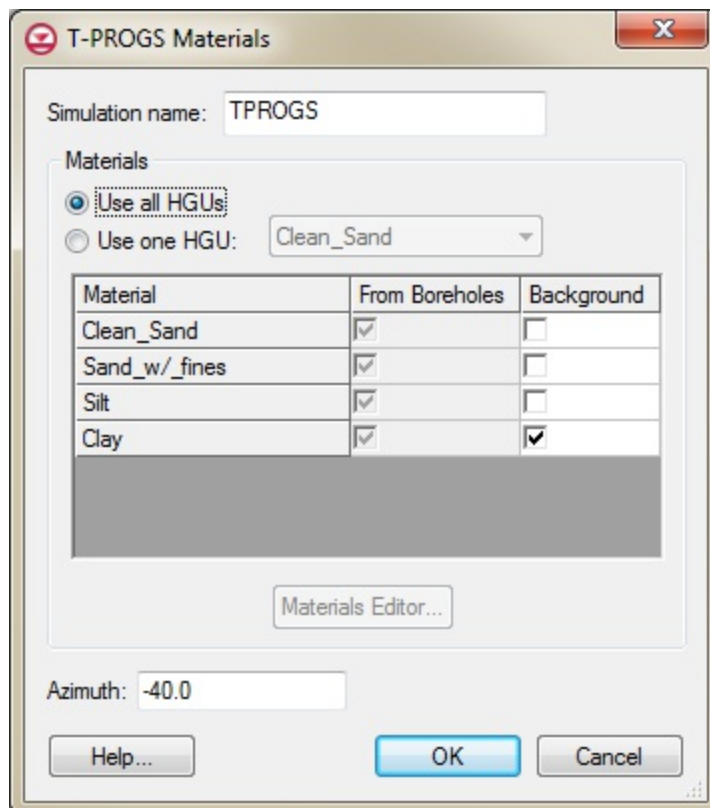

T-PROGS Materials dialog with borehole data.

When having selected the **New Simulation** command to initialize a T-PROGS simulation, the *T-PROGS Boreholes* dialog appears. Here select to use all boreholes or only the boreholes in a particular folder.

HGUs

Boreholes use materials to define both soils and [HGUs](#). HGUs can be used to group several materials into one hydrogeologic unit. The *T-PROGS Materials* dialog lets choosing to use the materials in all HGUs or those from just one HGU. If *Use all HGUs* is selected, T-PROGS will use the HGU information on the boreholes and ignore the soil information. If *Use one HGU* is selected, T-PROGS will use the soil information on the boreholes for the soils that are in the selected HGU. This feature can be used to limit the portion of the boreholes that are used in the T-PROGS simulation.

Material List

If boreholes do not exist in the model, an unconditioned simulation will be generated. In this case, in the *T-PROGS Materials* dialog select the materials to be used and a corresponding background material. The upper part of the dialog lists the materials in the boreholes. The first column of toggles indicates which materials are to be used in the analysis. By default, all materials associated with the boreholes are selected. These toggles are necessary since it is possible that there may be materials defined in the materials list that are not associated with boreholes. The second column in the top section of the dialog lists the background material. By default, the material type that had the predominant occurrence in the boreholes (greatest proportion) is marked as the background material. When defining the transition probability data in the next section, the input parameters do not need to be edited for the background material. The parameters for this material are automatically adjusted to balance the equations.

Background Material

Application of the transition probability approach involves the designation of a background material. The probabilistic constraints of the Markov chains make it unnecessary to quantify data for one category. Not only is it unnecessary, but it is futile to do so because values will be overwritten in order to satisfy constraints. Conceptually, the background material can be

described as the material that “fills” in the remaining areas not occupied by other units. For example, in a fluvial depositional system, a floodplain unit would tend to occupy area not filled with higher-energy depositional units and would therefore be a logical choice for the background material.

Azimuth

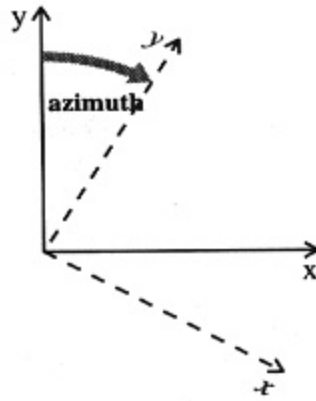

Azimuths for T-PROGS.

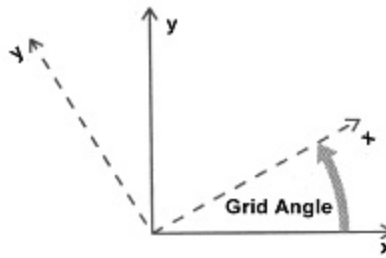

Azimuths for 3D Grid.

Also enter an azimuth in this dialog. The azimuth determines the orientation of the primary directions of the depositional trends in the strike/dip directions. These trends generally are aligned with the primary directions of horizontal flow in the aquifer. Theoretically, the azimuth can be oriented independently from the grid orientation. However, in practice, if the grid and azimuth orientations are offset by more than about 40° , checkerboard patterns appear in the indicator array results. Hence, the azimuth orientation is set equal to the grid orientation by default. However, the grid angle is defined counterclockwise, and the azimuth angle is

clockwise. Therefore, if the grid angle is 40° , then the azimuth angle will be -40° by default. If there is anisotropy in the xy plane, the azimuth angle should be set to the principle direction of the anisotropy. If anisotropy is not present, this angle should be coincident with the x-axis (the rows or j-direction) of the grid.

Material Limit

One limitation for both the cases with and without boreholes is that a maximum of five materials can be used in the T-PROGS algorithm. This limitation was imposed to keep the data processing and user-interface reasonably simple. Although five materials present a limitation, borehole data can generally be easily condensed down to five or fewer materials. Furthermore since this is a stochastic approach, which is based on probability, the detail generated with numerous materials is rarely justifiable anyway. In addition, as the number of materials increase, the ratio of process time to detail becomes inefficient.

Generating Material Sets with T-PROGS

The underlying equations solved by the T-PROGS software require an orthogonal grid with constant cell dimensions (X, Y, and Z). The delta X values can be different from the delta Y and delta Z values, and the delta Y values can be different from the delta Z values, but all cells must have the same change in X, Y, and Z dimensions. The MODFLOW model is capable of using the [Layer Property Flow \(LPF\) package](#) with the *Material ID* option for assigning aquifer properties. With this option, each cell in the grid is assigned a material id and the aquifer properties (Kh, Kv, etc.) associated with each material are automatically assigned to the layer data arrays for the LPF package when the MODFLOW files are saved. The T-PROGS software generates multiple material sets (arrays of material ids), each of which represents a different realization of the aquifer heterogeneity. When running a MODFLOW simulation in [stochastic mode](#), GMS automatically loads each of the N material sets generated by the T-PROGS software and saves N different sets of MODFLOW input files. The N solutions resulting from these simulations can be read into GMS and used to perform [risk analyses](#) such as probabilistic capture zone delineation.

One-Layer MODFLOW Grids

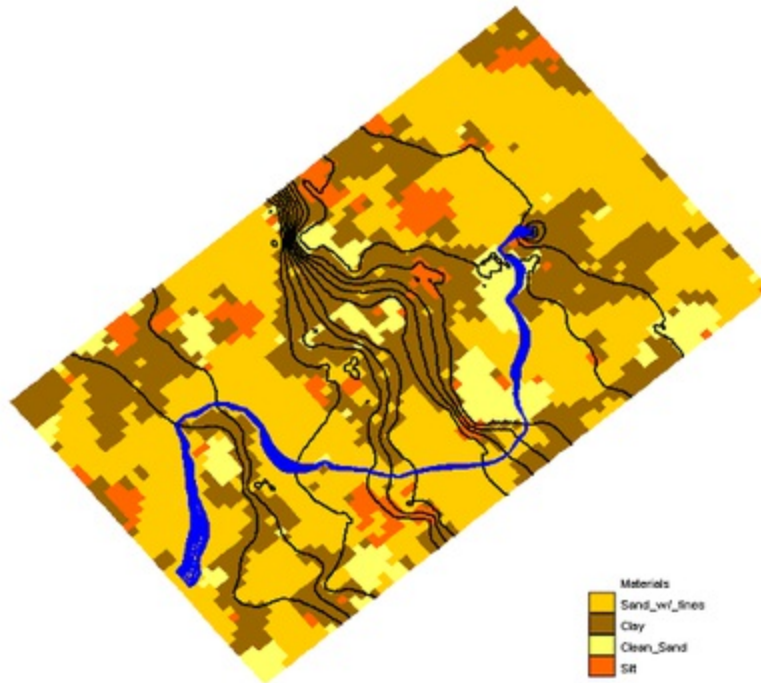

Sample material set generated by the T-PROGS software. Blue lines represent particle path lines and black lines are head contours.

Although MODFLOW is a three-dimensional model, a majority of the MODFLOW models constructed are 2D models consisting of one model layer. There are several reasons why 2D models are so common. One reason is that many of these models are regional models where the aquifer thickness is very small compared to the lateral extent of the model. As a result, the flow directions are primarily horizontal and little improvement is gained by adding multiple layers to the model. Even with local scale models, the aquifer thickness is often small enough that one-layer models are considered adequate. 2D models are also attractive due to the simplicity of the model increased computational efficiency. One of the problems associated with using multiple layers for MODFLOW models with unconfined aquifers is that as the water table fluctuates, the upper cells may go dry. These cells will not rewet even if the water table subsequently rises, unless the rewetting option has been selected in the flow package (BCF, LPF, or HUF). The rewetting issues can often be avoided with a one-layer model.

When developing a one-layer model, the modeler must determine how to distribute the hydraulic conductivity values within the layer. One option is to assume a homogenous

aquifer; this is typically a gross over-simplification since aquifers are usually highly heterogeneous. Therefore, a common approach is to delineate zones of hydraulic conductivity by examining the subsurface stratigraphic data. In many cases, these data are in the form of borehole logs. These borehole logs often exhibit substantial heterogeneity and don't always exhibit definitive trends between adjacent boreholes. Furthermore, the boreholes are often clustered with large regions of the model lacking any borehole data. The modeler then faces a difficult task of trying to determine a rational approach to delineating two-dimensional zones of hydraulic conductivity based on complex 3D borehole data.

As part of this research, we developed a technique for developing 2D zones of hydraulic conductivity from borehole logs using transition probability geostatistics. The technique is simple, fast, and preserves proportions and trends exhibited by the borehole data. The algorithm parses through each borehole and computes a predominant material at each borehole. When T-PROGS runs, the predominant material for each borehole is assigned to its corresponding location in the one-layer grid, and during the quenching process, simulations are conditioned to those data points.

Generating HUF Data with T-PROGS

Using transition probability geostatistics with MODFLOW models results in two basic limitations. First, the underlying stochastic algorithms used by the T-PROGS software are formulated such that the MODFLOW grid must have uniform row, column, and layer widths. The row width can be different from the column width, but each row must have the same width. This results in a uniform orthogonal grid. While MODFLOW grids are orthogonal in x and y, the layer thickness is allowed to vary on a cell-by-cell basis. This makes it possible for the layer boundaries to accurately model the ground surface and the tops and bottoms of aquifer units. If a purely orthogonal grid is used, irregular internal and external layer boundaries must be simulated in a stair-step fashion either by varying material properties or by activating/inactivating cells via the IBOUND array. A second limitation is that in order to get a high level of detail in the simulated heterogeneity, the grid cell dimensions are generally kept quite small. This can result in difficulties in the vertical dimension. The large number of layers with small layer thicknesses near the top of the model generally ensures

that many of the cells in this region will be at or above the computed water table elevation (for simulations involving unconfined aquifers). As a result, these cells will undergo many of the numerical instabilities and increased computational effort issues associated with cell wetting and drying.

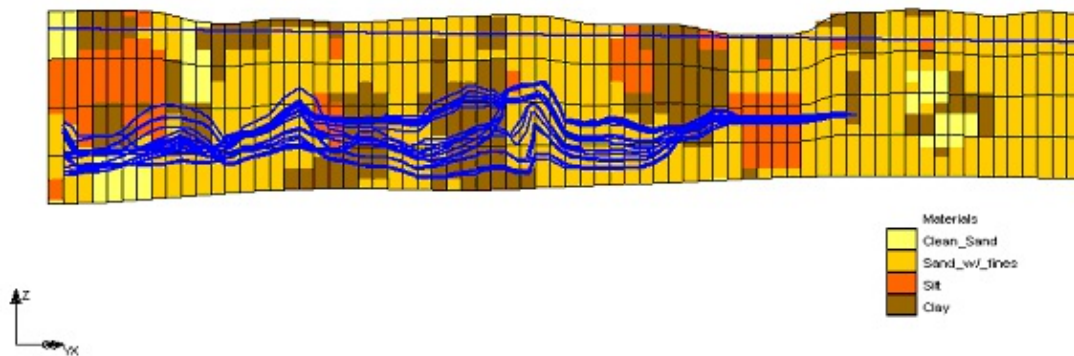

Sample HUF stratigraphy data generated by the T-PROGS software. Blue lines represent particle path lines and water table.

The Hydrogeologic Unit Flow (HUF) package released with MODFLOW 2000 makes it possible to overcome both of these limitations resulting in a powerful mechanism for incorporating transition probability geostatistics in MODFLOW simulations. With the HUF package, the modeler is allowed to input the vertical component of the stratigraphy in a grid-independent fashion. The stratigraphy data are defined using a set of elevation and thickness arrays. The first array defines the top elevation of the model. The remaining arrays define the thicknesses of a series of hydrogeologic units, starting at the top and progressing to the bottom of the model. For each array of thicknesses, many of the entries in the array may be zero. This makes it possible to simulate complex heterogeneity, including pinchouts and embedded lenses that would be difficult to simulate with the LPF and BCF packages.

The T-PROGS interface in GMS includes an option for integrating transition probability geostatistics results with the HUF package. The basic approach used by the option is to overlay a dense background grid on the MODFLOW grid and run T-PROGS on the background grid. A set of HUF arrays is then extracted from the background grid for use with the MODFLOW model. To use this option, first create a MODFLOW grid with the

desired number of layers and the layer elevations should be interpolated to match the aquifer boundaries. The row and column widths are uniform but the layer thicknesses may vary from cell to cell. Then, when TSIM is launched, the HUF option should be selected. GMS then generates a background grid that encompasses the MODFLOW grid. The rows and columns of this grid match the MODFLOW grid but the layer thicknesses are uniform and relatively thin, resulting in a much greater number of layers than the MODFLOW grid. Specify the number of layers in this background grid. A T-PROGS simulation is then performed to get a set of material sets on the background grid. Each of the material sets in the T-PROGS output is then transferred from the background grid to a set of HUF elevation/thickness arrays. The HUF top elevation array is set equal to the top of the MODFLOW grid. The thickness arrays are then found by searching through the background grid to find the bottom elevations of contiguous groups of indicators. The elevations from these groups are then added to an appropriate elevation array in the HUF input. The resulting set of HUF input arrays are listed in GMS [Project Explorer](#). By clicking on each item in the [Project Explorer](#), the selected set of HUF arrays are loaded into the HUF package and the corresponding stratigraphy is displayed in the GMS window. The multiple HUF input arrays can be used to perform a [stochastic simulation](#).

Vertical Markov Chain

A dialog assists in defining the vertical Markov chains. This dialog is composed of three main sections:

- Plot section
- Markov Chains section
- Spreadsheet section

All three sections enable developing a 1-D Markov chain in the vertical direction.

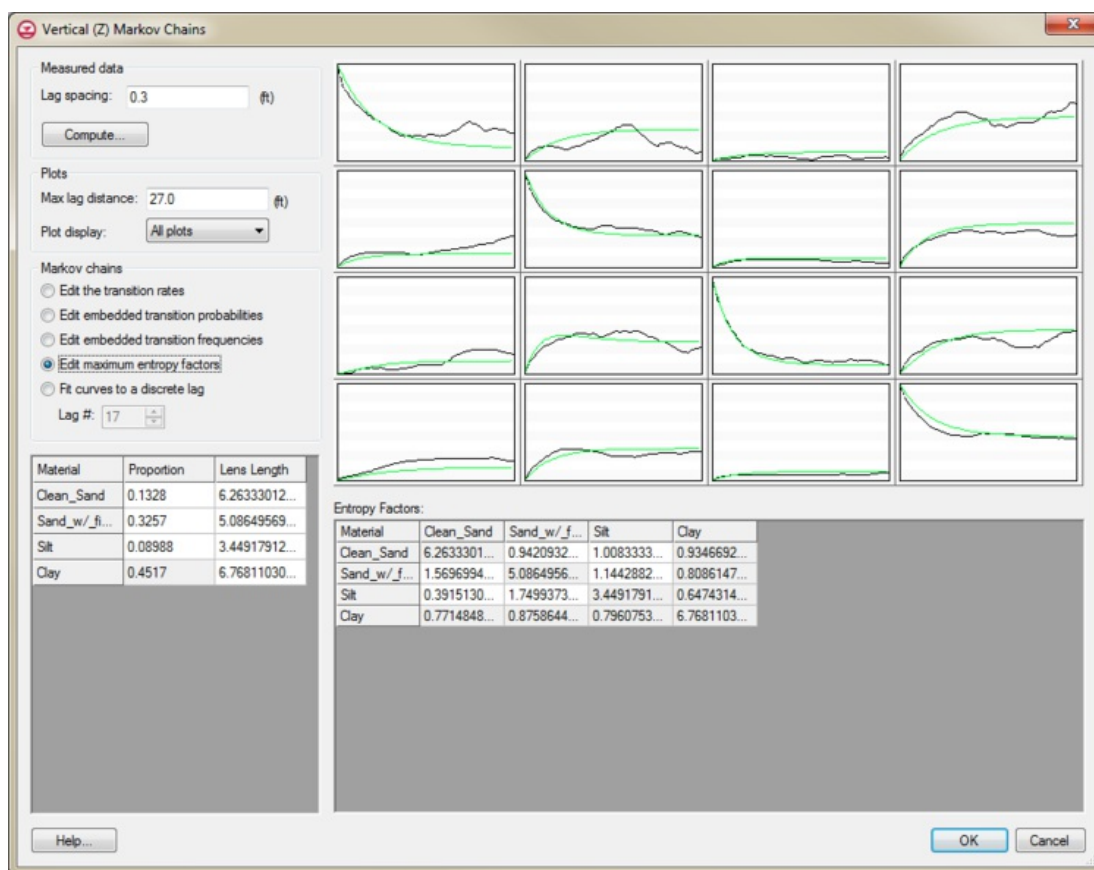

Vertical Markov Chain dialog.

Plot section

The plot section includes the array of curves, the *Lag spacing* edit field, the **Compute** button, and the *Max lag distance for plots* edit field. The number of plots in the array produced correlates to the number of materials used in the simulation. If N materials are used, an N by N array of plots will illustrate the transition probabilities for each material with respect to every other material. Every plot is labeled with a name and units and can be maximized with a command in the menu produced by right-clicking on the curve in question. The curves are automatically regenerated anytime a change is made in the other sections of the dialog.

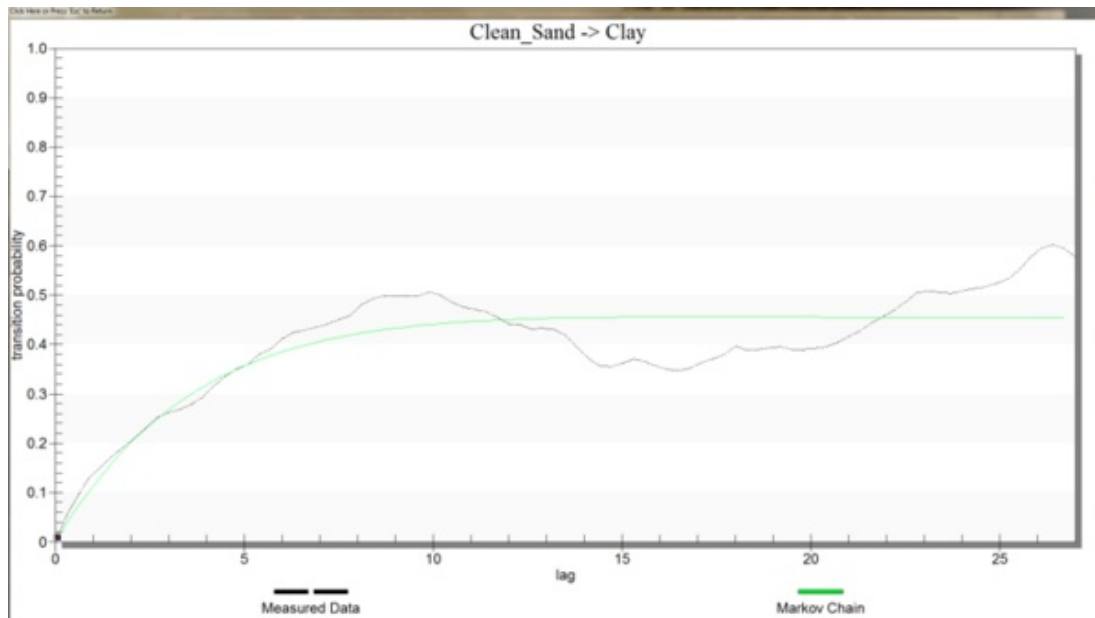

Transition probability plot.

Each of the plots contains two curves depicting the transition probability. The dashed line represents the transition probability measured from the borehole data by the GAMEAS utility. In general, this curve represents the transition probability from material j to material k . The transition probability $t_{jk}(h)$ is defined by:

$$t_{jk}(\mathbf{h}) = \Pr\{k \text{ occurs at } \mathbf{x} + \mathbf{h} \mid j \text{ occurs at } \mathbf{x}\}$$

where x is a spatial location, h is the lag (separation vector), and j, k denote materials. The lag is defined by the Lag spacing item in the upper left corner of the *Vertical (Z) Markov Chains* dialog. The curve shown with the solid line is called a "Markov Chain". The Markov Chains are used to formulate the equations used by T-PROGS to generate the multiple material sets during the simulation stage. The objective of this stage of the analysis is to fit

the Markov Chain curves as accurately as possible to the measured transition probability curves. This process is similar to fitting a model variogram to an experimental variogram in a kriging exercise. The transition rates are adjusted to ensure a good fit between the Markov Chain model and the observed transition probability data.

Mathematically, a Markov Chain model applied to one-dimensional categorical data in a direction Φ assumes a matrix exponential form:

$$T(h_{\Phi}) = \exp(R_{\Phi}h_{\Phi})$$

where Φ denotes a lag in the direction h_{Φ} , and R_{Φ} denotes a transition rate matrix

$$R_{\Phi} = \begin{bmatrix} r_{11,\Phi} & \cdots & r_{1k,\Phi} \\ \vdots & \ddots & \vdots \\ r_{k1,\Phi} & \cdots & r_{kk,\Phi} \end{bmatrix}$$

with entries $r_{jk,\Phi}$ representing the rate of change from category j to category k (conditional to the presence of j) per unit length in the direction Φ . The transition rates are adjusted to ensure a good fit between the Markov Chain model and the observed transition probability data.

It should be noted that the self-transitional curves on the diagonal start at a probability of 1.0 and decrease with distance and the off-diagonal curves start at zero probability and increase with distance. In both cases, the curves eventually flatten out at some distance. The probability corresponding to the flat part of the curve represents the mean proportion of the material. All curves on a particular column should flatten out to the same proportion. The proportions are displayed in the lower left corner of the dialog. The point where a tangent line from the early part of the curves on the diagonal intersects the horizontal (lag distance) axis on each curve represents the mean lens length for the material. The mean lens lengths are shown just to the right of the mean proportions in the lower left part of the dialog. The slope at the beginning of each of the Markov Chains represents the transition rate. Together, the proportions, lens lengths, and transition rates define the Markov Chains.

Several methods are provided for fitting the Markov Chains to the measured transition probability curves. These methods are listed in the section of the dialog titled *Markov Chains*. By default, GMS automatically makes an attempt to fit the curves using the **Edit maximum entropy factors** option. In many cases, this fit is sufficiently accurate and we can proceed to the next step. However, it is often useful to explore the other options for

fitting the curves.

If boreholes exist in the model, the **Compute...** button becomes undimmed. When clicking the **Compute...** button, the parameter files required for running GAMEAS are generated and GAMEAS is executed.

GAMEAS

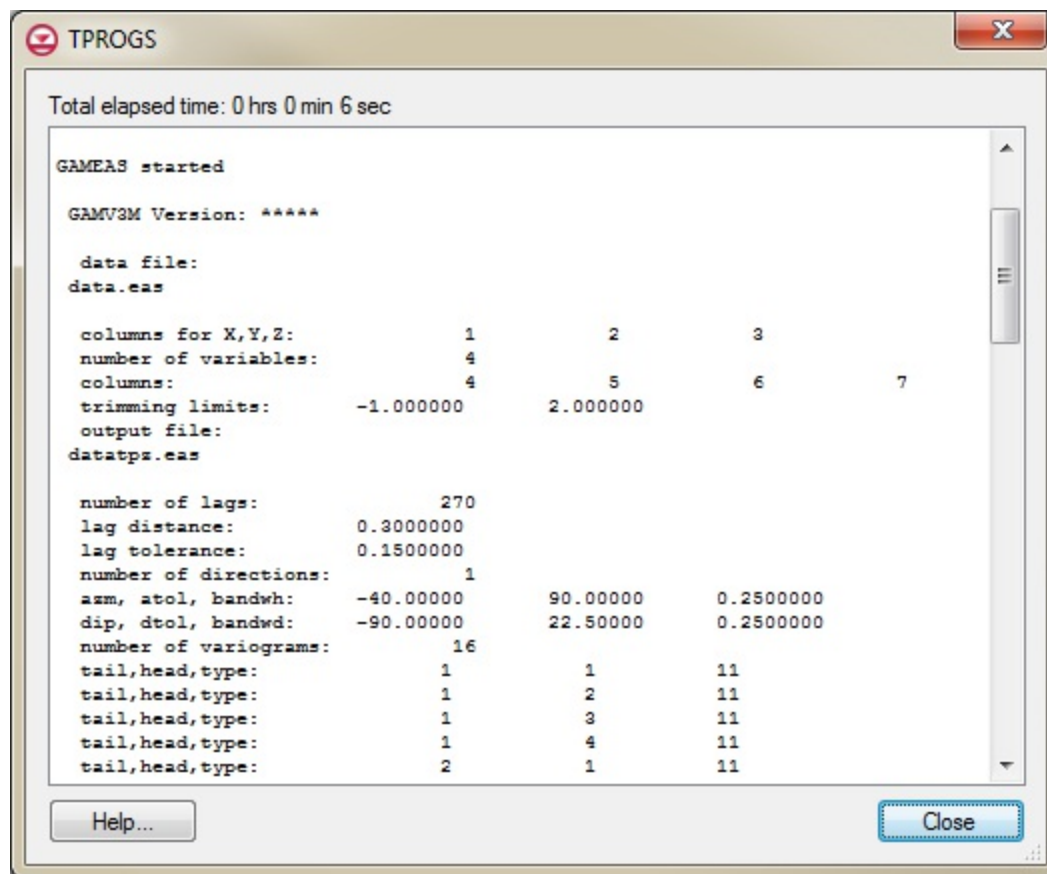

GAMEAS executable inside GMS interface.

GAMEAS is an algorithm that processes borehole data and determines geologic characteristics such as material proportions and transition probability curves in a given direction. A separate window displays the details of the GAMEAS run, which allows monitoring the output from the GAMEAS simulation.

When GAMEAS completes a successful run, the results, including the material proportions and transition probability curves from the measured data, are read into the corresponding data fields in the *Vertical Markov Chain* dialog. Furthermore, the transition rates which correspond to the slope of the transition probability curves when the lag equals 0 are

interpolated from the measured data curves. In addition to running GAMEAS, the code parses through the borehole data and calculates the embedded transition probabilities and frequencies. These values are stored in arrays that correspond to options #2 and #3 in the *Markov Chains* section of the dialog.

Lag

The *Lag spacing* determines how dense the curves are, and the Max lag distance for plots determines the range of the curves. The curves always range from 0 to the Max lag distance for plots horizontally, and they range from 0 to 1 vertically to honor probability constraints.

Markov chains section

There are five alternate methods of generating Markov chains in this section (area in the *Vertical Markov Chain* dialog). These methods are in a radio-button configuration to allow changing from one method to another. Each of these five methods will be described.

- [Edit the transition rates](#)
- [Edit embedded transition probabilities](#)
- [Edit embedded transition frequencies](#)
- [Edit maximum entropy factors](#)
- [Fit curves to a discrete lag](#)
- [Edit the transition rates](#)

Edit the transition rates

With this option one can directly edit the array of transition rates that are listed in the Transition Rates section. This option is useful after selecting the Compute button and running GAMEAS because slopes can be inferred from the measured data curves. GAMEAS outputs transition probability curves. Transition rates used in this option correspond to the slope of the transition probability curve at a lag = 0. When reading the output from GAMEAS, the transition probability rates are interpolated as

$$r_{jk,\phi} = 0.57 * r1_{jk,\phi} + 0.29 * r2_{jk,\phi} + 0.14 * r3_{jk,\phi}$$

where $r1$, $r2$, and $r3$ are the slopes defined by a straight line from the origin out to lag1, lag2, and lag3 respectively. As the lag approaches zero, more weight should be given to the corresponding slope. Hence, a weight of 0.57, 0.29, and 0.14 were assigned to $r1$, $r2$, and $r3$ respectively. Once the slopes are computed for each entry in the matrix, the mean lengths for each category are computed by

$$\bar{L}_{j,\phi} = \frac{-1}{r_{jj,\phi}}$$

Regardless of which *Markov Chain* option is selected, the background row and column, Sand_w/_fines, is dimmed because the values in this row and column are automatically computed from the remaining entries by probability constraints of the background material. In addition, with this option selected, the *Lens Length* column is also dimmed because the lens lengths are automatically computed and updated from the diagonal terms in the Transition Rates spreadsheet. The diagonal terms of the *Transition Rates* spreadsheet must be negative to obey probability rules. With this data, this method produces an accurate fit between the measured (green) and the Markov chain (blue) curves at small lag spaces.

Edit the embedded transition probabilities

This is a more intuitive method of generating Markov chains and is conducive to sites with and without data. It is conducive to sites with data because the embedded transition probabilities can be determined from the borehole data. When a simulation is initialized, if borehole data exist default embedded transition probabilities are computed from the borehole data. If borehole data do not exist, the embedded transition probabilities can be estimated with some basic geologic knowledge including the average mean lengths of each material for each direction and depositional trends.

With this option selected, the diagonal terms are dimmed because these values are derived from the values entered in the *Lens Length* column. Adjusting the proportions, lens lengths, or the off-diagonal terms in the *Transition Rates* spreadsheet alters the curves.

With this option, the spreadsheet in the lower right of the dialog represents the probability that the row material will transition to the column material moving vertically upwards in the

+Z direction.

Edit the embedded transition frequencies

This option is similar to option #2, except embedded transition frequencies populate the off-diagonal terms of the *Transition Rates* spreadsheet. Embedded transition frequencies are also computed from borehole data when a simulation is initialized if borehole data exist.

Once again, this is an intuitive framework with geologic knowledge including average mean lengths and depositional trends.

Edit maximum entropy factors

While this option can be used with borehole data, it is ideally suited for cases without borehole data. With this option, the user edits the proportions for all but the background material and the mean lens lengths for all materials. The lens lengths are used to populate the diagonal terms of the *Transition Rates* spreadsheet, and the maximum entropy factors fill the off-diagonal terms of the spreadsheet. The maximum entropy factors represent the ratio of the transition rate to the maximum entropy transition rate. A maximum entropy factor of 1.0 represents maximum disorder in depositional tendencies. A rate greater than 1.0 indicates that the two categories tend to occur next to each other. A factor less than unity would infer the opposite. This is an intuitive method of generating Markov chains and is conducive to all types of sites. This method enables logical incorporation of anisotropy into the model with the maximum entropy factors.

Fit curves to a discrete lag

This option is only undimmed if a transition probability curve from measured data exists in memory. When this option is selected, the *Lag #* edit field is undimmed to allow entering the discrete lag the curves will be fit to.

This option produces Markov chains that are computed from the measured transition rates produced by GAMEAS. GAMEAS computes a set of transition probabilities at each specified lag. This option computes an array of transition rates from the slope of the curves generated by GAMEAS (green). The transition rates correlate to the shape of the curve from the origin to the specified lag number in the *Lag #* edit field. Therefore, the cells of all

the spreadsheets in the dialog are dimmed because the values are inherited from the measured curves (green). The values in the spreadsheets change depending on the lag # entered. By adjusting the lag interval, an excellent fit can often be obtained.

Spreadsheet section

This section includes two separate spreadsheets: *Transition Rates* and *Proportions & Mean Lengths* spreadsheets. The *Transition Rates* spreadsheet contains the rate entries that correspond to the selected option in the *Markov Chains* section. The *Proportions* column holds the proportions for each material. The *Mean Lengths* column contains the average mean length in the vertical direction for each material. The data in these spreadsheets define the Markov chains.

Strike Dip Markov Chain

Once the vertical Markov chains have been defined, the *Strike (X) Markov Chains* dialog become available. This dialog has the same general setup as the [Vertical Markov Chain](#) dialog.

Strike (X) Markov Chains

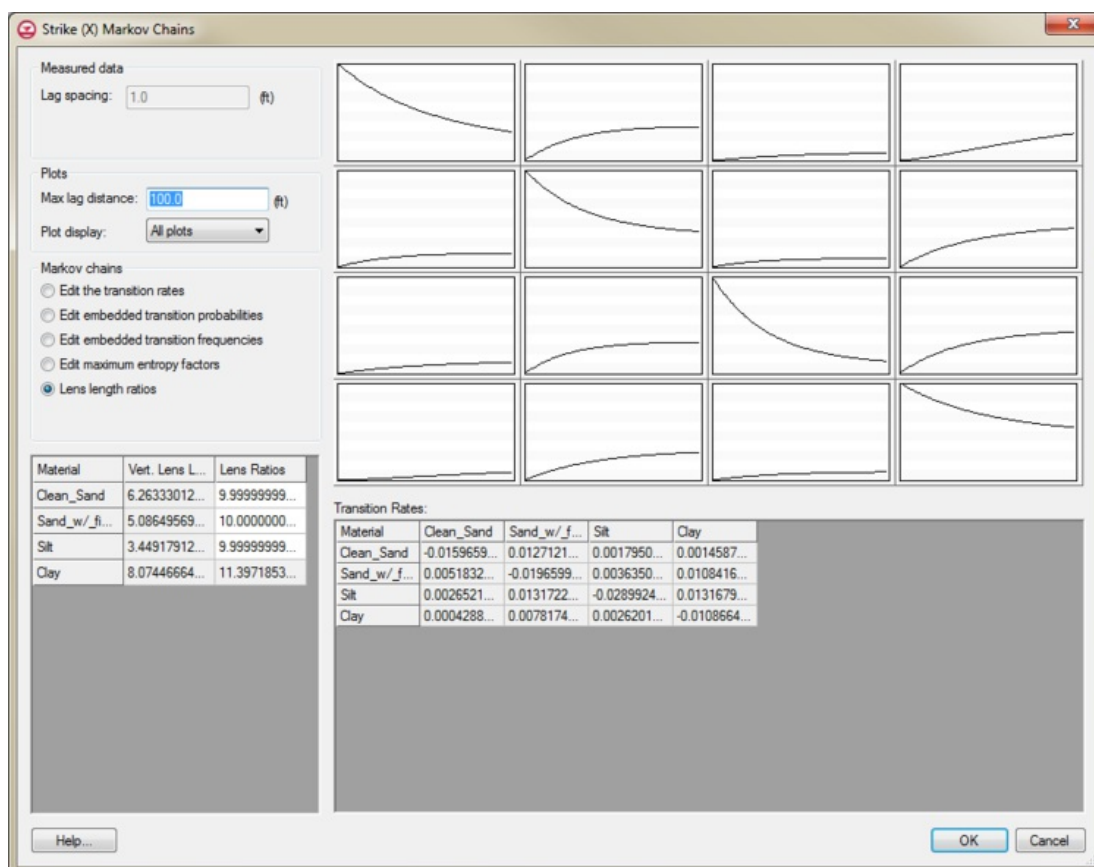

Strike/Dip Markov chain dialog.

There are three minor differences between this dialog and the vertical dialog. The first difference is in the [Markov Chains](#) section. The option, *Lens width ratios*, replaces the *Fit curves to a discrete lag* option. The *Fit curves to a discrete lag* option is not applicable because horizontal measured transition probability curves do not exist due to lack of data in the horizontal direction. The *Lens width ratios* option is the default option and should be

used in most cases. This option allows applying the transition data entered in the vertical direction to the horizontal direction. The proportion data are directly inherited from the vertical data.

The second change is in the [spreadsheet section](#). Rather than entering the mean lengths, enter a ratio corresponding to the ratio of the lens length in the x direction to the lens length in the z direction. For example, if the lens length for material A is 5 feet in the z direction and 10.0 is entered for the ratio, then the lens length in the x direction would be 50 feet. The *Lens Width Ratios* option is particularly useful because the only required input is lens length ratios for the non-background materials. The remaining data are all inherited from the vertical data. The third change is in the [plot section](#). Due to the lack of measured data in the horizontal direction, each plot contains only one curve: the Markov chain curve.

Vertical→Lateral Data Conversion

Typical site stratigraphic data is conducive to developing vertical spatial variability. However, rarely is the quantity of data adequate to develop an accurate model in the lateral directions. The combination of Walther's Law and the transition probability approach allows for a logical method of developing lateral spatial variability from vertical spatial variability. Walther's Law states that vertical successions of deposited facies represent the lateral succession of environments of deposition. Therefore, a logical method of generating a 3-D model of spatial variability would be first to develop a 1-D Markov chain in the [vertical direction](#) based on site data, assuming there is such data. Second, using Walther's Law and geologic knowledge, one can develop lateral, strike and dip, Markov chains of spatial variability. However, one issue that arises when applying vertical transition trends to lateral directions is how to cope with asymmetric vertical trends like fining upwards. For example, if in the vertical direction, sand tends to deposit on gravel as would be typical in a fluvial deposition, there will be a transition rate associated with the transition of "sand→gravel" and "gravel→sand". The transition of "gravel→sand" will be greater than "sand→gravel" because of the fining upward trend. However, in the lateral direction, which of these transition rates should be applied? Although the trend of sand next to gravel remains in the lateral direction, the transition rates of "sand→gravel" and "gravel→sand" should be equivalent or symmetric as defined by

$$r_{jk} = \frac{p_k}{p_j} r_{kj}$$

The strategy for averaging the vertical transition rates to come up with the lateral rates is given in the three steps below.

1. Compute the lower-half rate (R-ls) that will satisfy symmetry with the upper-half rate (R-u) for the vertical data using the symmetry relation.
2. Set the lower-half rate for the lateral direction (R'-l) equal to (R-l + R-ls)/2
3. Compute the upper-half rate for the lateral direction (R'-u) that will satisfy symmetry with the new lower-half rate (R'-l) using the symmetry relation.

In addition to the averaging technique applied to the off-diagonal terms of the lateral transition rates, an adjustment was made to the diagonal terms of the rate matrix. It will be remembered that the diagonal terms correlate to the average mean lengths by

$$\bar{L}_{j,\phi} = \frac{-1}{r_{jj,\phi}}$$

Generally, in depositional patterns, lateral mean lengths are larger than their counterparts. Therefore, the lateral mean lengths generally need to be increased by a prescribed factor F. This factor F is equal to the ratio of the lateral mean lengths/vertical mean lengths. If the mean length for category K increases by a factor F, the corresponding transition rate will decrease by that same factor F. And the row sum for category K must therefore decrease by the factor F.

Dip (Y) Markov Chains

The *Dip (Y) Markov Chain* dialog has an identical appearance and functionality as the *Strike (X) Markov Chains* dialog.

TSIM

When a **T-PROGS** simulation  has been created, TSIM can be run to generate either **material sets** on a **3D grid** or **HUF** data for **MODFLOW**. TSIM is run via the **T-PROGS | Run TSIM** menu command. This brings up the TSIM Wizard.

Step 1

In the first step of the *TSIM* wizard, choose to run TSIM now from GMS or save the input files in order to run TSIM later. If not running TSIM from GMS, no material sets or HUF arrays will be created.

Step 2

Running TSIM from GMS

Part two of the TSIM model run is the *TSIM Options* dialog.

TSIM Options

Simulation name: TPROGS

Number of realizations: 1 Seed: 2511

Max. # of quenching iterations: 4

Quenching tolerance: 0.00001

TSIM output

- Generate material sets
- Generate HUF Arrays
- Create material probability datasets

Background grid

Num X: 70

Num Y: 50

Num Z: 4

Target grid layers

- All layers
- Layers: Min: 1 Max: 4
- Named layer ranges:

Named layer ranges: [Empty list]

Help < Back Finish Cancel

The TSIM Options dialog

Option	Description
<i>Number of realizations</i>	The number of material sets or HUF sets that will be generated.
<i>Seed</i>	The random number seed used by TSIM. This is generated by GMS but can be changed. Running TSIM with the same inputs and see will result in identical outputs.
<i>Max. # of quenching iterations</i>	A TSIM parameter. "No more than five quenching iterations are usually necessary – too many iterations may produce unrealistic artifacts."
<i>Quenching tolerance</i>	A TSIM parameter. "The tolerance limit sets a criteria for terminating quenching based on the value of the objective function as normalized relative to its initial value."
<i>TSIM Output</i>	Choose to generate material sets or, if a MODFLOW model exists which uses the HUF package, HUF arrays.
<i>Create material probability datasets</i>	This will cause datasets to get created, one per material, where the dataset values equal the probability that that material occurs in the given cell.
<i>Background Grid</i>	The dimensions and number of grid ranks of the background grid are determined from the 3D grid in the project. If generating HUF arrays, specify the number of grid layers in the vertical (Z) direction.
<i>Target grid layers</i>	Starting at GMS version 8.0, it is possible to target a subset of grid layers. The resulting material sets will have inactive values outside of the targeted area. Specify the min and max layers or the named layer ranges to target.

Saving files to run TSIM later

The option in Step 2 if saving the TSIM files for later use are similar to those for running TSIM in GMS. Specify a file and where it is to be saved. Also, the dimensions and number of ranks of the background grid must be specified. Finally, no material sets or HUF arrays will be generated.

T-PROGS Commands

The *T-PROG* menu becomes available when a T-PROG simulation has been created. The menu contains the following commands:

New Simulation...

Creates a new T-PROG simulation.

Delete Simulation

Removes a T-PROG simulation from the Project Explorer.

Materials...

Brings up the *T-PROG Materials* dialog. See [T-PROGS Materials](#) for more information.

Vertical (Z) Markov Chains...

Brings up the *Vertical (Z) Markov Chain* dialog. See [Vertical Markov Chain](#) for more information.

Strike (X) Markov Chains...

Brings up the *Strike (X) Markov Chain* dialog. See [Strike Dip Markov Chain](#) for more information.

Dip (Y) Markov Chains...

Brings up the *Dip (Y) Markov Chain* dialog. See [Strike Dip Markov Chain](#) for more information.

Run TSIM...

Starts the TSIM Wizard. See [TSIM](#) for more information.

Related Topics

- [T-PROGS](#)
- [Commands](#)

6.16. TOUGH

TOUGH

Some individuals have worked to allow GMS to be used as a pre- and post-processor for [TOUGH](#) (Transport Of Unsaturated Groundwater and Heat), a numerical model maintained by the [Lawrence Berkeley National Laboratory](#). It is used for geothermal reservoir engineering with applications for nuclear waste disposal, environmental remediation problems, energy production from geothermal, oil and gas reservoirs as well as gas hydrate deposits, geological carbon sequestration, vadose zone hydrology, and other uses that involve coupled thermal, hydrological, geochemical, and mechanical processes in permeable media.

GMS does not have an interface for TOUGH but it can [export UGrids](#), including 3D Voronoi UGrids, as TOUGH2 mesh files. There are also some resources below on how to implement TOUGH with GMS.

Resources

- [TOUGH software website](#)
- Borgia, A., L. Cattaneo, D. Marconi, C. Delcroix, E. L. Rossi, G. Clemente, C. G. Amoroso, F. Lo Re, and E. Tozzato. "Using a MODFLOW grid, generated with GMS, to solve a transport problem with TOUGH2 in complex geological environments: The intertidal deposits of the Venetian Lagoon." *Computers & Geosciences* 37, no. 6 (2011): 783-790.
- Borgia, A., M. Calcara, L. Cattaneo, and M. Kennard. "Hydro-Geochemical Modelling in the Passo A Campalto Phosphogypsum Dump in the Lagoon of Venezia, Italia." *Proceedings, TOUGH Symposium 2012*, (2012): 451-457.

7. Modeling

7.1. Calibration

Model Calibration

An important part of any groundwater modeling exercise is the model calibration process. In order for a groundwater model to be used in any type of predictive role, it must be demonstrated that the model can successfully simulate observed aquifer behavior.

Calibration is a process wherein certain parameters of the model such as recharge and hydraulic conductivity are altered in a systematic fashion and the model is repeatedly run until the computed solution matches field-observed values within an acceptable level of accuracy.

Calibration is the process of modifying the input parameters to a groundwater model until the output from the model matches an observed set of data. GMS includes a suite of tools to assist in the process of calibrating a groundwater model. Both point and flux observations are supported. When a computed solution is imported to GMS, the point and flux residual errors are plotted on a set of [calibration targets](#) and a variety of plots can be generated showing overall calibration statistics. Most of the calibration tools can be used with any of the models in GMS. [Automated parameter estimation](#) is supported for [MODFLOW](#) models via [PEST](#).

Two types of [observations](#) can be defined in GMS: [point observations](#) and [flow observations](#). Both types of observations are defined in the [Map module](#) and are associated with [points, arcs, and polygons](#). Point observations represent locations in the field where some value has been observed. In most cases, the points will correspond to observation wells and the value will be the elevation of the groundwater table (the head). Flow observations represent linear or areal objects such as streams and reservoirs where the gain or loss between the aquifer and the object has been measured or estimated. Both point and flow observations can be assigned a confidence interval or calibration target. While point observations can be used with any model, flow observations can only be used with MODFLOW.

Once a set of observed point and flow values has been entered, each time a model solution is imported, GMS automatically interpolates the computed solution to the observation points. For some models ([MODFLOW](#)) the model outputs the computed values at the

observation points. Also, MODFLOW outputs the computed flow for the flow observations. A calibration target representing the magnitude of the residual error is displayed next to each observation point and each flow object as shown below. The residual is calculated as the observed value minus the simulated value which matches MODFLOW. The size of the target is based on the confidence interval or the standard deviation. In addition to the calibration targets next to the observation points, a user can choose to display any of a number of statistical [plots](#).

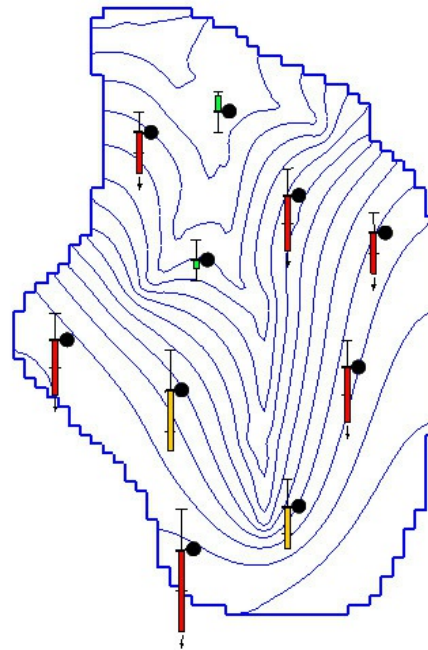
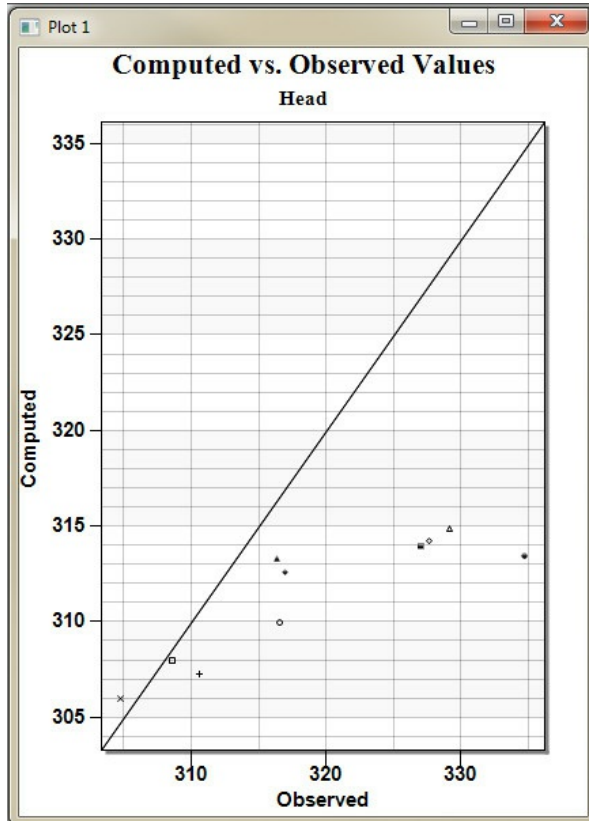

Calibration Targets and Plots of Calibration Statistics.

Automated Parameter Estimation

An important part of any groundwater modeling exercise is the [model calibration](#) process. In order for a groundwater model to be used in any type of predictive role, it must be demonstrated that the model can successfully simulate observed aquifer behavior. Calibration is a process wherein certain parameters of the model such as recharge and hydraulic conductivity are altered in a systematic fashion and the model is repeatedly run until the computed solution matches field-observed values within an acceptable level of accuracy.

One of the tools provided in GMS for is automated parameter estimation. With automated parameter estimation, an external utility, sometimes called an "inverse model", is used to iteratively adjust a set of [parameters](#) and repeatedly launch the model until the computed output matches field-observed values. Parameter estimation is used in conjunction with the [point observations](#) and the [flow observations](#).

Automated parameter estimation is supported in GMS for the [MODFLOW](#) simulations using [PEST](#) a general purpose parameter estimation utility developed by John Doherty of Watermark Computing.

Inverse models should only be used carefully and with a full understanding of the assumptions, equations, and methods involved. It is suggested that the user read the available documentation on the inverse model being used. Only the steps involved in setting up an inverse model are described in this document.

Basic Steps

The basic steps involved in using an inverse model for parameter estimation are follows:

- 1. Create a Working MODFLOW Model**

The first step is to create a MODFLOW model and run a simulation. Before launching the inverse model, it's necessary to have a MODFLOW model that successfully converges and it's necessary to determine a good set of starting values for the

parameters. Once there is a solution it is also a good idea to copy the computed heads from the solution to the starting heads array. This ensures that as the inverse model modifies the parameters and runs MODFLOW repeatedly, it is more likely that MODFLOW will quickly converge each time it is launched.

2. Enter the Observations

Once there is a working MODFLOW model, enter the head and flux observations.

[Head observations](#) are entered as points using an observation coverage in the Map module. [Flow observations](#) are assigned directly to arcs and polygons in source/sink coverages. Each of the observations is assigned a [weight](#) that is saved to the inverse input files.

3. Turn on the Inverse Model

Select an inverse model. Bring up the [Global Options](#) dialog and select either the *Parameter Estimation* or *Stochastic Inverse Model* option depending on whether a stochastic simulation is being run.

4. Parameterize the Model

The next step is to parameterize the model. See the [Parameters](#) page for more details.

5. Create a Parameter List

The next step is to create the parameter list. See the [Parameters](#) page for details.

6. Set Parameter Estimation Options

Once the parameter list is set up, the user may wish to edit the general [Parameter Estimation](#) options. These options include the output control and convergence criteria.

7. Edit the Group Weight Multipliers

The [group weight multipliers](#) can be edited to adjust the relative weight of the head and flux observations.

8. Edit the PEST ASP Package

Edit the MODFLOW [PEST ASP Package](#) if necessary in order to ensure a stable solution.

9. Save and Run MODFLOW Model

Once all of the inverse model options have been set, the next step is to save the

MODFLOW model using the **Save** or **Save As** command in the *File* menu. Next, run MODFLOW and the inverse model will run with MODFLOW. The inverse model will then be launched in a separate window or the model wrapper in which the user should see information relating to the MODFLOW runs and the status of the objective function. Depending on the problem, the inverse model may take anywhere from several minutes to several hours (or days) to run to completion. When the inverse process is completed successfully, GMS automatically launches a MODFLOW forward run with the optimal values computed by the inverse model. Thus, the solution will reflect the optimal values computed by the inverse model.

10. **Viewing the Optimal Values**

When the inverse model is finished, it writes out a text file containing the set of parameter values corresponding to the minimum calibration error. These values can be viewed with the **Import Optimal Values** button. This copies the optimal parameter values to the *Starting Value* field in the *Parameter List*.

Sensitivity Analysis

At each PEST iteration, PEST computes the sensitivities of each of the parameters. This information is available in the "*model.sen*" file (where *model* is the name of the MODFLOW model). PEST records the composite sensitivity and the relative composite sensitivity of each parameter in this file. This information is useful in determining which parameters have the greatest effect on the model as well as which parameters have the least effect on the model. Thus, the "insensitive" parameters can be removed or held constant in a subsequent PEST run.

For a more detailed description of parameter sensitivity see section 5.3.2 of the PEST manual.

PEST Dialog

Options affecting parameter estimation can be changed via the [PEST dialog](#).

Parallel PEST

The PEST model can be run with parallel processing across one or multiple machines with the parallel PEST utility. Running across multiple machines requires setup outside of GMS with PSLAVE. More information about parallel PEST can be found in the [PEST Manual Part I](#) starting on page 222 from the [PEST Downloads page](#).

See also

[Model Calibration](#)

Observations

Observations can be either point observations or flow observations.

Point Observations

The primary type of field data used in a typical calibration exercise is point observations. Point observations represent values that are measured at some location in the field. Point observations generally correspond to water table elevations measured at observation wells. However, multiple observed values can be defined at each observation point. Observation points are managed in the Map module using the [Coverage Setup](#) dialog.

Flow Observations

Flow observations represent gains or losses between aquifers and streams or reservoirs. In addition to point observations, flow observations are an essential part of a calibration exercise for a flow model. If calibration is attempted using point observations only, there may be many combinations of parameters such as hydraulic conductivity and recharge that will result in the same head distribution. Adding one or more flow observations serves to "pin down" the flow quantity resulting in a set of hydraulic conductivities and recharge values that are more likely to be unique.

While the point observation tools are model independent, GMS only supports flow observations for MODFLOW and [FEMWATER](#). With MODFLOW, observed flows are assigned to selected arcs and polygons making up the MODFLOW conceptual model in the Map module. When a MODFLOW solution is imported, the computed flows are read for the arcs and polygons and compared with observed values.

With a FEMWATER simulation, observed values cannot be assigned to objects in the FEMWATER conceptual model. However, when a FEMWATER solution is imported, the computed flows on selected model boundaries can be automatically summed. Comparison of computed vs. observed flows must then be made manually.

Observation Weights

When performing [automated parameter estimation](#), a set of head and flow observations are defined using points, arcs, and polygons in the Map module. When entering the point and flow observations, care should be taken when entering the calibration interval and confidence values. These values are used to determine the weights assigned to each observation in the inverse model. The weight is multiplied by the residual for the observation in the objective function. The weight that is sent to the inverse model input files by GMS is computed as

$$\frac{1}{(\text{Standard Deviation})^2 * \text{Group Weight}}$$

Note that GMS will automatically convert from an interval and a confidence to a standard deviation, or directly enter the standard deviation.

Group Weight Multipliers

In addition to the individual weight, a group weight can also be assigned. Group weights are assigned using the Group Weight section of the *Observations* dialog. This dialog is accessed by selecting the **Observations** command in the *MODFLOW* menu.

A group weight can be assigned to each of the following observation types:

1. **Head observations.**
2. **Constant head flow observations.**
3. **River flow observations.**
4. **General head flow observations.**
5. **Drain flow observations.**
6. **Stream flow observations.**

Options 2-6 correspond to flow observations that are defined using the Observed flow rate option.

The default value for the group weights is 1.0. The default value can be changed to give a

larger influence to a particular observation type. For example, if a particular model had sixteen head observations and one flux observation corresponding to a stream gage, a better solution may be obtained by increasing the flux group weight to give more weight to the stream gage measurement.

Observations Dialog



Observations dialog.

This dialog (*MODFLOW* | **Observations**) is used to manage which coverages that contain MODFLOW observation data will be applied to the current simulation. It is also used to apply group weights. This dialog can only be accessed when observations have been created using the [Map Module](#) in a MODFLOW conceptual model.

MODFLOW-USG is different from previous versions of MODFLOW in that it does not support an Observation Process. Computed values at observations for MODFLOW-USG are handled by a series of PEST utilities. The input to these utilities is created in the [MODFLOW-USG Observation](#) dialog.

Group Weights

These weights can be used to emphasize (or deemphasize) a type of observation for the simulation.

Coverages

This spreadsheet allows choosing which observation coverages will be used in the current simulation. This can be helpful if there are observations for a site from different times, but only wanting to use one of the times.

Export Trans. Obs.

Beginning with version 8.0, this button allows exporting a *.csv (comma separated values) file with transient observation data. This file can be loaded into excel to create plots of the transient observation values vs. the model computed values. An example of using this data is included in the [MODFLOW- Managing Transient Data](#) tutorial.

Confidence Interval and Standard Deviation

The interval and standard deviation are related by the following equation:

$$sd = \frac{CI}{z}$$

where *sd* is the standard deviation, *CI* is the confidence interval, and *z* is the the "z statistic" based on the specified confidence and the normal distribution. Enter an interval and confidence, and the standard deviation will be computed; or enter a standard deviation and confidence, and the interval will be computed.

In practical terms entering an interval (or standard deviation) and confidence is an indication of how much error is believed to be associated with the observed value.

The standard deviation becomes important when using an inverse model. The weight assigned to each of the observations points is a function of the standard deviation. This weight is used in the objective function that the inverse model tries to minimize. An observation point with a small standard deviation will have a greater influence on the objective function than a point with a large standard deviation.

Enter an interval (or standard deviation) and confidence in the [Properties](#) dialog. Although these values are rarely quantified the following examples may prove helpful.

For example, if having the following set of head measurements for one observation well:

Date	Head
May 10, 1998	55.0
July 10, 1998	50.5
September 5, 1998	48.6
November 15, 1998	49.1
February 2, 1999	50.8
March 12, 1999	54.0
April 1, 1999	57.2

The mean of the data is 52.17 and the standard deviation is 3.25. Enter this standard deviation and a confidence of 95%.

Many times there is not this much data available. Usually there will only be one measured value. In this case use engineering judgement to estimate an interval or standard deviation. For example, if there is a single head measurement of 45.7 ft and it is believed that observation is accurate to within a 1 foot. Then enter 1 foot as the interval.

See also

- [Automated Parameter Estimation](#)

MODFLOW-USG Observations

[MODFLOW-USG](#) does not support an observation process as does MODFLOW 2000, 2005, NWT, ect. When using MODFLOW-USG in GMS a series of PEST utilities are run to calculate the model computed values at observations. The inputs to these utilities are managed in the *MODFLOW-USG Observation* dialog. This dialog contains information for head observations as well as flow observations. The head and flow observations can be steady state or transient depending on the type of MODFLOW-USG simulation.

Generating Observation Data

Observation data is generated from [coverages](#) in the [conceptual model](#). The generation of MODFLOW-USG observation data may occur manually by selecting the **Generate PEST Obs. Data** button in the *MODFLOW-USG Observations* dialog (*MODFLOW | Observations* command) or when using the [Map→MODFLOW](#) command.

Generate PEST Obs. Data Dialog

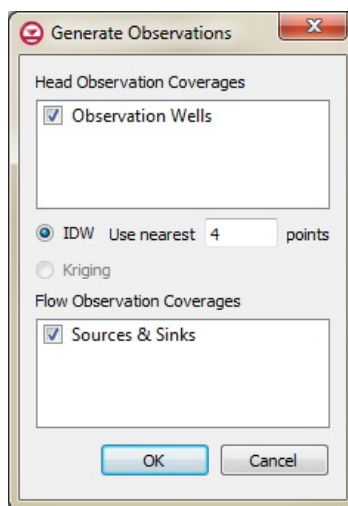

Generate Observations dialog

The *Generate PEST Obs. Data* dialog allows selecting the coverages and settings used to

generate observation data. The top of the dialog contains a list of coverages that have MODFLOW Head observations. Any selected coverages will be used to generate the observation data. If the MODFLOW model is steady state then only coverages with the "Head" observation property will be used (as opposed to the "Trans. Head" property). Below the list of Head observation coverages, specify the interpolation option to be used in calculating the model computed value at the observation points. GMS 10.1 supports IDW interpolation where the user may specify the number of nearest grid cells to use.

The next section of the dialog lists coverages that have flow observations. Similar to head observations, if the MODFLOW model is steady state then only coverages with the *Observed Flow* boundary condition property will be used (as opposed to the *Trans. Observed Flow* property).

NOTE: Determining MODFLOW Model Layer for Observation Points

GMS allows multiple methods for assigning observation point to MODFLOW models including: specifying the layer, using the elevation or Z of the point, or using a well screen. This option is specified in the [Coverage Setup](#) dialog under the *3D grid layer option for obs. pts.* If choosing the well screen option then the middle of the well screen is used to find the layer of the UGrid; the nearest points in that layer are used to interpolate to the observation point.

Map → MODFLOW

When executing the **Map → MODFLOW** command GMS will generate observation data for any coverage that has *Head Observations* and any coverage that has *Flow Observations*.

Head Observations

The generated head observation data is stored in three tables: Wells, WellToNode, and WellSample.

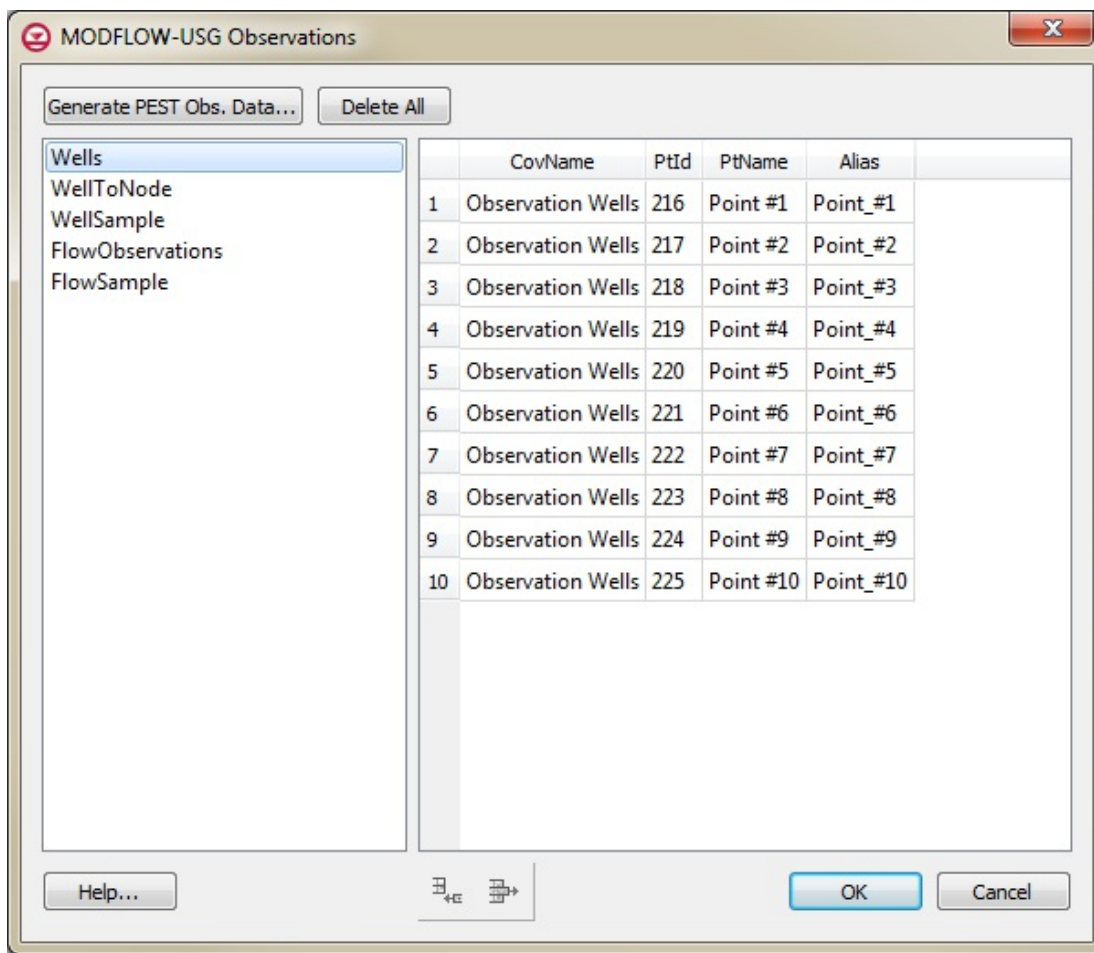

Wells Table

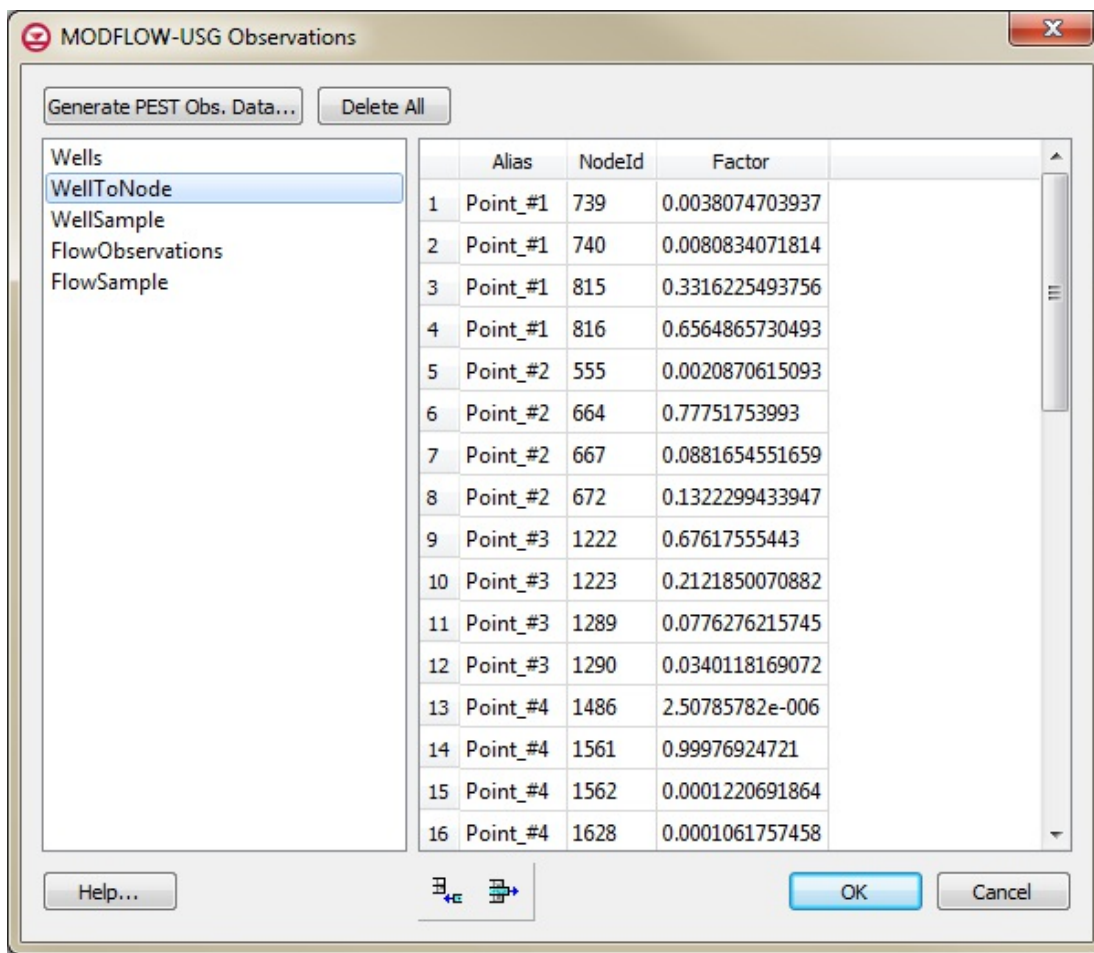

Well To Node Table

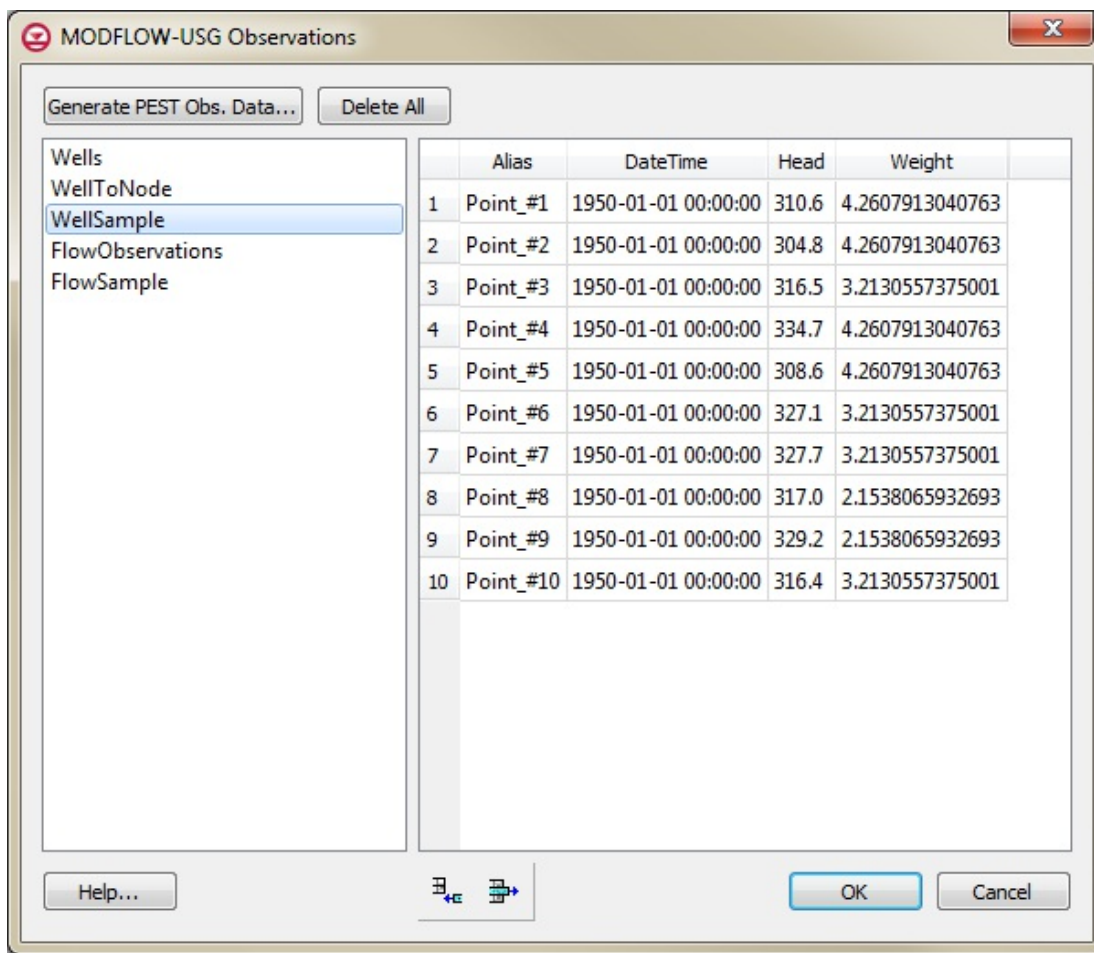

Well Sample Table

Wells Table

The *Wells* table provides a list of all of the observation points found in the specified coverages. The table lists the source Coverage Name (CovName), point id (PtId), point name (PtName), and Alias. The *Alias* field is a string that meets the requirements for "borenames" in the PEST utilities. The alias must be unique (ignoring case), 10 characters or less, and contain no spaces. GMS generates aliases for each of the observation points. If the name of the point satisfies the alias criterion then it is used. None of the data in *Wells* table can be edited.

WellToNode Table

The *WellToNode* table lists the information necessary to interpolate from the UGrid cells to the observation point. The table lists the *Alias* (same as the Alias listed in the *Wells* table), id of the UGrid cell (*NodeId*), and an interpolation factor for the UGrid cell (*Factor*). The

user may edit the values of *Alias*, *NodeId*, and *Factor* as desired. *Alias* may only be one of the aliases specified in the *Wells* table. The user may also *Add* or *Delete* rows in the table.

WellSample Table

The *WellSample* table lists measurements taken at the observation points. The table lists the *Alias* (same as the *Alias* listed in the *Wells* table), the date/time that the measurement was taken (*DateTime*), and the value of the measurement (*Head*). When the MODFLOW model is steady state then the *DateTime* field will contain a value of 1950-01-01 00:00:00. The user may edit the values of *Alias*, *DateTime*, and *Head* as desired. *Alias* may only be one of the aliases specified in the *Wells* table. Many different date time formats may be entered into the *DateTime* field. Regardless of the format entered, the date time will be reformatted into the YYYY-MM-DD HH:MM:SS format.

If the user is not using date time format for the observation data then dates and times will be created using 1950-01-01 00:00:00 as time zero and date times are assigned based on the time units of the MODFLOW-USG simulation.

PEST Utilities for Head Observations

The PEST utility `usgmod2obs1.exe` is run after a MODFLOW-USG model successfully terminates to calculate the model computed values at the observation points. This utility is run using a batch file called `usgmod2obs.bat`. This file is written to the same directory as the MODFLOW-USG simulation. The `usgmod2obs1.exe` utility has several prompts asking the user for input as it runs. The responses to these prompts are written to the file `usgmod2obs.in`. Three different text files `*.obsusg.n2b`, `*.obsusg.blisting`, and `*.obsusg.bsamp` are written using data from the *Wells*, *WellToNode*, and *WellSample* tables when the MODFLOW-USG simulation is saved. These files are used as part of the input to this utility. The PEST documentation contains the format description for these files. The output from the utility will be a file `*.obsusg.bsamp.out` that lists the well alias, date time, and head measurement; these are the model computed values at the observation points. The `*.obsusg.bsamp.out` file is read as part of the MODFLOW-USG solution, used to compute residuals, and used to display calibration targets.

When the MODFLOW-USG model is transient, another batch file: `usgmod2obs-mftimes.bat`

is written. This batch file runs the same usgmod2obs1.exe utility. This batch file will calculate model computed values for the observation points at all of the MODFLOW-USG output time steps. This is done so that when the user views the solution in GMS the model computed value at each observation point at each output time will be available for inspection. An additional file: *.obsusg-mftimes.bsamp is written as input to this batch file. The output of the batch file will be *.obsusg-mftimes.bsamp.out. This file has the same format as *.obsusg.bsamp.out and is also read as part of the MODFLOW-USG solution.

Head Observation Files

Name	Description
USGMOD2OBS.IN	Input File
OBSUSG.N2B	Cell Node Factor File
OBSUSG.BLISTING	List of Wells File
OBSUSG.BSAMP	Well Sample File
OBSUSG.B2B	Bounds File
OBSUSG.B2MAP	Well Coordinates File
OBSUSG.BWT	Well Weight File
OBSUSG	USG Observation Index File

Transient Observation Files

Name	Description
MFTIMES.BAT	Batch File
MFTIMES.BSAMP.OUT	Output File
MFTIMES.BSAMP	Sample File

Flow Observations

The generated flow observation data is stored in 2 tables: *FlowObservations* and *FlowSample*. Flow observations may be assigned to points, arcs, arc groups, and polygons that are associated with a MODFLOW boundary condition (drain, general head...).

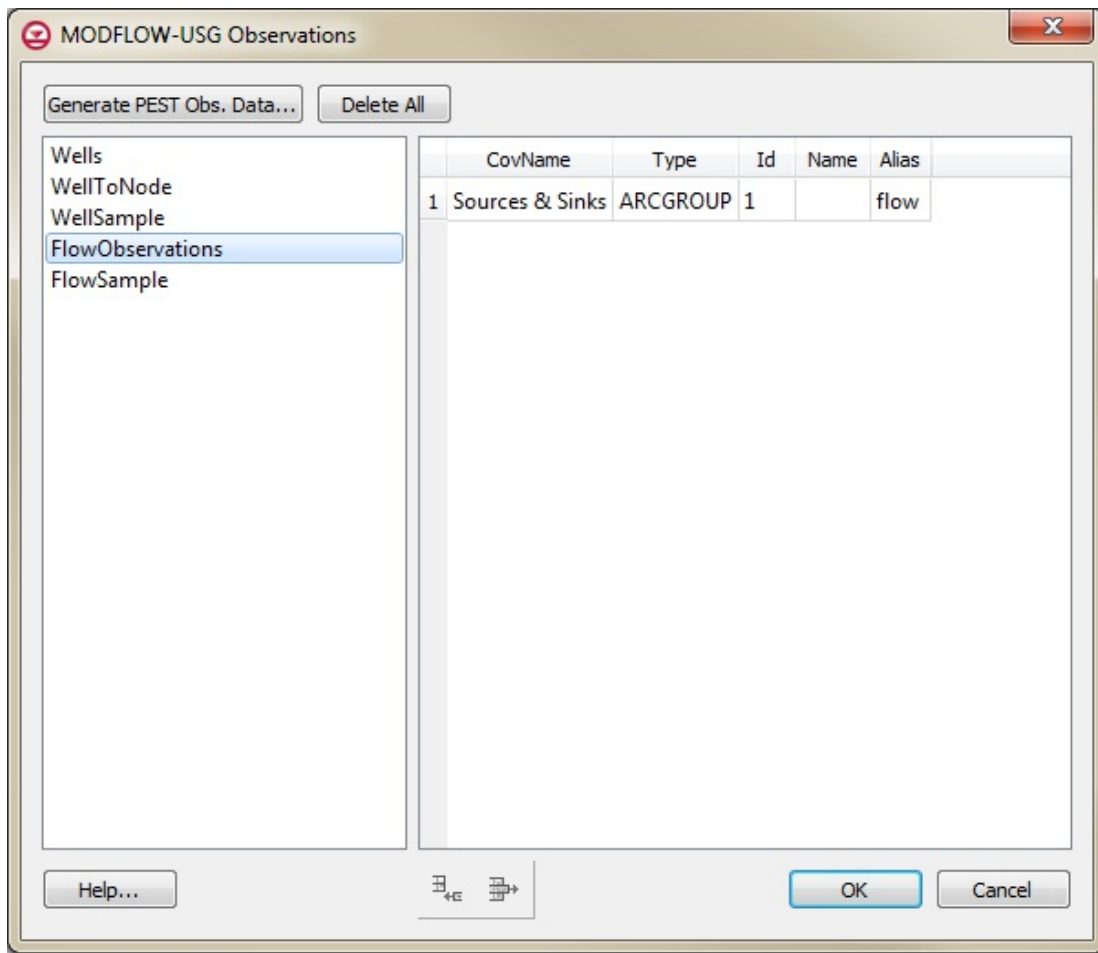

FlowObs Table

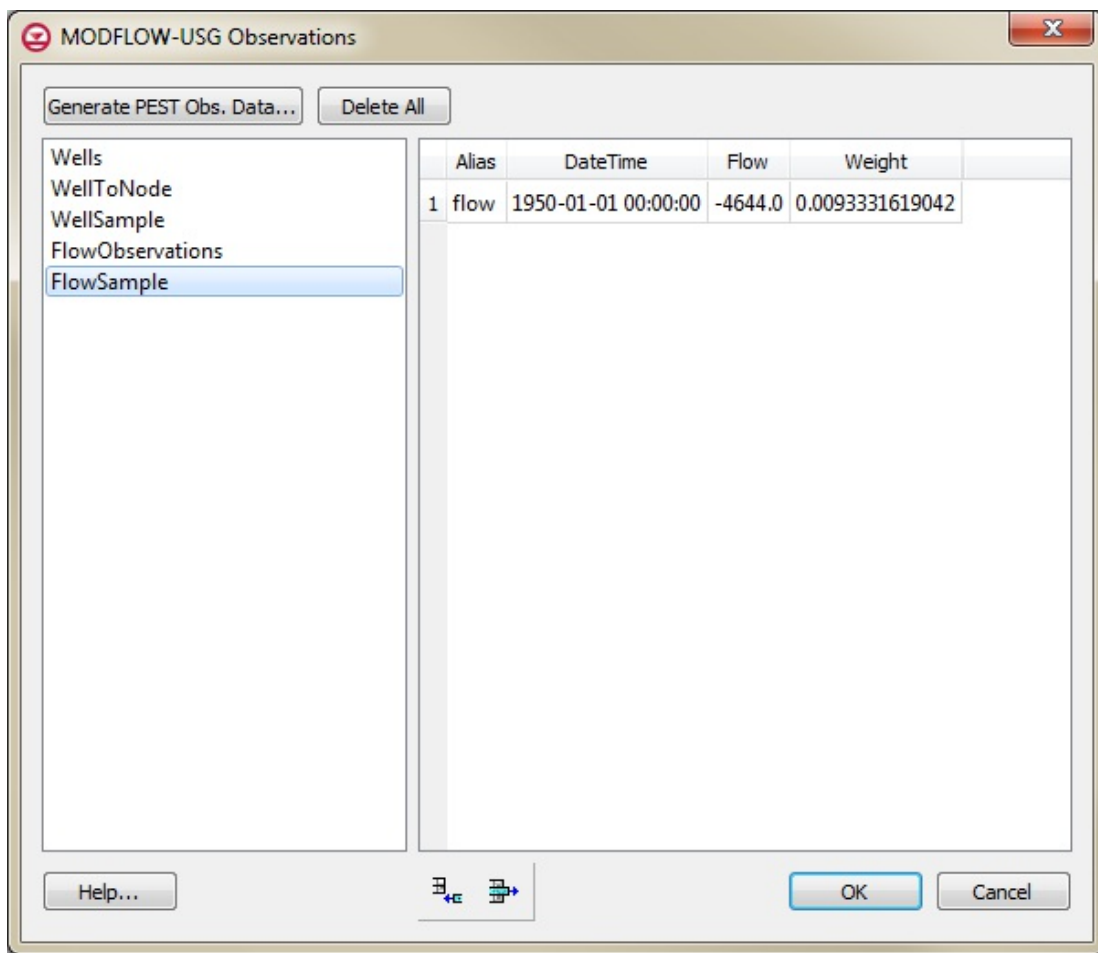

FlowSample Table

FlowObservations Table

The FlowObservations table provides a list of all of the flow observations found in the specified coverages. The table lists the source Coverage (CovName), the feature object type (Type), the id of the feature object (Id), the name of the feature object (Name), and the Alias. The same rules apply to the Alias in this table as apply to the Alias in the Wells table. None of the data in FlowObservations table can be edited.

FlowSample Table

The FlowSample table is just like the WellSample table only applied to flow observations.

PEST Utilities for Flow Observations

The PEST utilities usgbud2smp1.exe and smp2smp.exe are run after a MODFLOW-USG model successfully terminates to calculate the model computed flows at the flow

observations. This utility is run using batch files called usgbud2smp.bat and usgsmp2smp.bat. These files are written to the same directory as the MODFLOW-USG simulation. The usgbud2smp1.exe utility has several prompts asking the user for input as it runs. The responses to these prompts are written to the file usgbud2smp.in. Two different text files *.obsusgf.b2b and *.obsusgf.fsamp are written using data from the FlowObservations and FlowSample tables when the MODFLOW-USG simulation is saved. These files are used as part of the input to this utility. The PEST documentation contains the format description for these files. The output from the utility will be a file *.obsusgf.samp that lists the flow observation alias, date time, and flow measurement; these are the model computed values at the observations at the model output times. The smp2smp.exe utility does temporal interpolation from the model output times to the observation times and the output from this utility is a file .obsusgf.fsamp.out. The *.obsusgf.fsamp.out file is read as part of the MODFLOW-USG solution, used to compute residuals, and used to display calibration targets.

Flow Observation Files

Name	Description
OBSUSG.FWT	Flow Weight File
OBSUSG.FSAMP	Flow Sample File

Plot Wizard

Plots are useful for many purposes, such as extracting data from two or three dimensional objects and model verification. Plots are created through the *Plot Wizard*.

The *Plot Wizard (Display | Plot Wizard)* is used to create 2D plots. The plot wizard is composed of two steps described below. In addition, the types of plots that can be created are described and illustrated below.

Plot Wizard Step 1

In the first step, the plot type is selected. The types include:

- Computed vs. Observed Data
- Computed vs. Observed Data (Weighted)
- Residual vs. Observed Data
- Residual vs. Observed Data (Weighted)
- Parameter Sensitivities
- Error vs. Simulation
- Error vs. Time Step
- Error Summary
- Time Series
- Active Dataset Time Series Plot
- S/S Flow vs. Time
- Flow Budget vs. Time
- Gage Package Value vs. Time

A sample and explanation are displayed for each plot type. The **Next >** button is undimmed

if the necessary data for the selected plot type exists in the current project. If the **Next >** button is disabled, a help text explaining the problem is displayed below the *Plot Type* box.

Plot Wizard Step 2

In the second step, the attributes of each plot are set. The attributes associated with each plot type are explained below and can be located quickly by clicking on the desired plot type listed above. The options depend on the plot type and will be described below.

Computed vs. Observed

A Computed vs. Observed plot is used to display how well the entire set of observed values match a model solution. A 45° line is drawn on this plot, which represents a perfect correspondence between observed data and solution values. One symbol is drawn for each observation point at the intersection of the observed and computed values for the point. This plot can show the trend of the solution values with regard to matching the [observed data](#). Only those points whose value is specified as observed for the selected data type will be shown in the plot. These plots are created in the *Plot Wizard* by setting the *Plot Type* to "Computed vs. Observed".

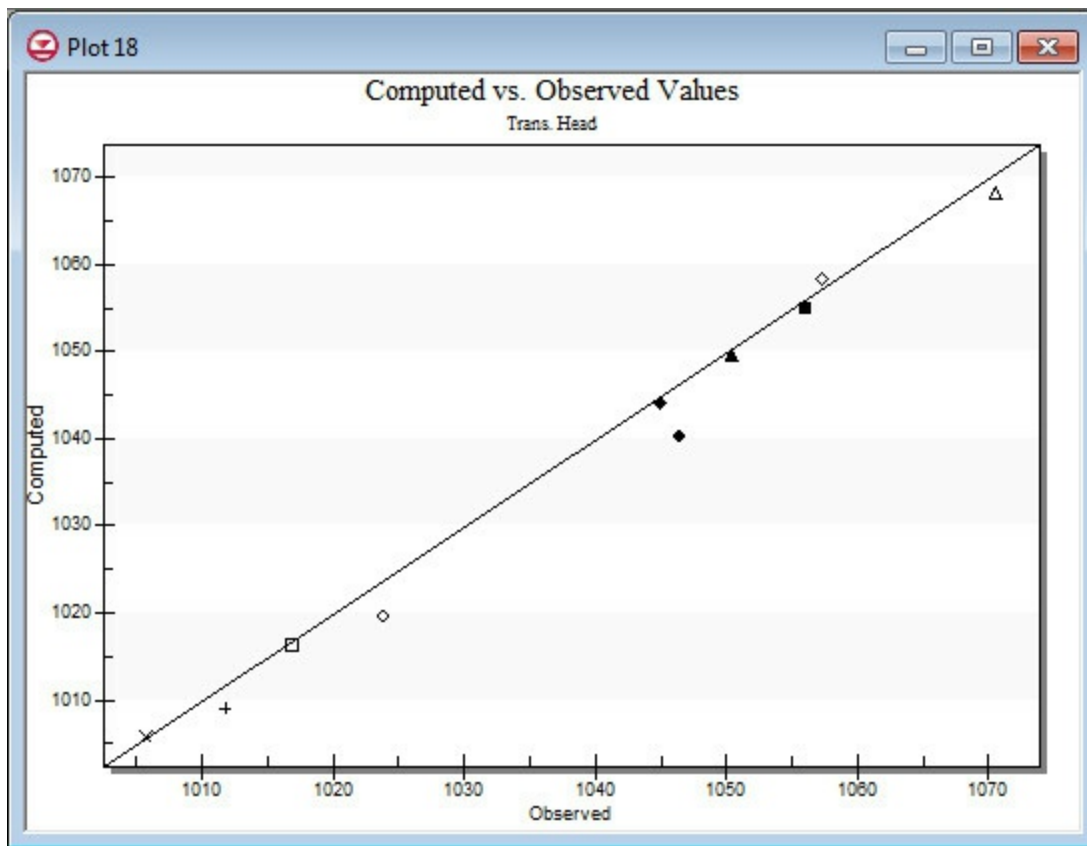

Computed vs. Observed Plot Options

The second step contains the following options.

Coverage and Measurements

The observation coverage and measurements can be selected for each plot. If only one observation coverage and measurement exist these are used by default.

Use current solution

This option causes the plot to compare the observed values with the values of the current solution and time step for each observation point. When the active solution changes, the plot is recomputed and updated. If only one solution is in memory then this option is defaulted.

Use selected solutions

This option causes the plot to compare the observed values with the values of the specified solution for each observation point. Changing the active solution does not affect the plot.

Use time step

Because the plot shows only values from a specific time step, the active time step is used by default.

Computed vs. Observed (Weighted)

A Computed vs. Observed Weighted plot is used to display how well the entire set of weighted observed values match a model solution. These weights are set by selecting the **Observation** item in the *MODFLOW* menu. A 45° line is drawn on this plot, which represents a perfect correspondence between observed data and solution values. One symbol is drawn for each observation point at the intersection of the weighted observed and computed values for the point. This plot can show the trend of the solution values with regard to matching the weighted observed data. Only those points whose value is specified as observed for the selected data type will be shown in the plot. This plot is not available with transient data. These plots are created in the *Plot Wizard* by setting the *Plot Type* to "Computed vs. Observed (Weighted)".

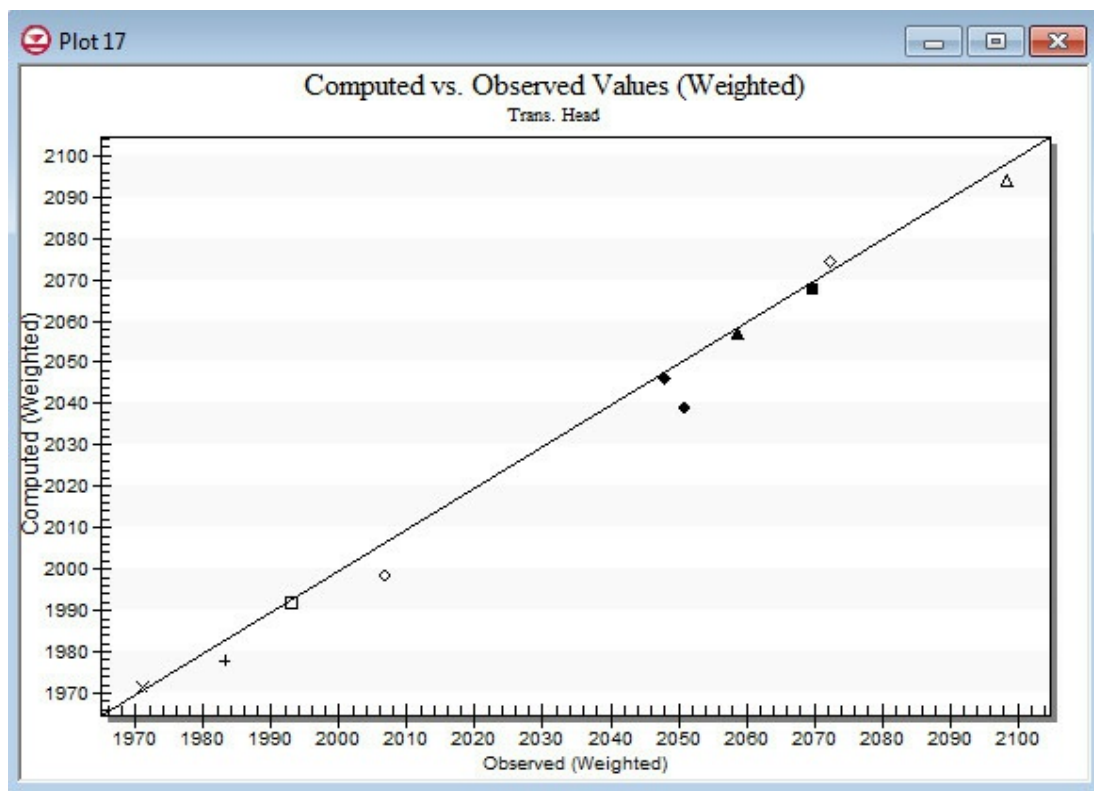

Computed vs. Observed Weighted Plot Options

After the plot type is set in the first page of the *Plot Wizard*, the **Next** button is clicked to open the *Computed vs. Observed Weighted Plot Options* wizard page. This page contains the following:

Coverage and Measurements

The observation coverage and measurements can be selected for each plot. If only one observation coverage and measurement exist these are used by default.

Use current solution

This option causes the plot to compare the weighted observed values with the values of the current solution and time step for each observation point. When the active solution changes, the plot is recomputed and updated. If only one solution is in memory then this option is defaulted.

Use selected solutions

This option causes the plot to compare the weighted observed values with the values of the specified solution for each observation point. Changing the active solution does not affect the plot.

Use time step

Because the plot shows only values from a specific time step, the active times step is used by default.

Residual vs. Observed

A Residual vs. Observed plot is used to display how well the entire set of observed values match a model solution. On this plot is drawn a horizontal line along an error of zero, representing what would be a perfect correspondence between observed data and solution values. Then, one symbol is drawn for each observation point at the intersection of the observed and residual (computed-observed) values for the point. This plot can show the trend of the solution values with regards to matching the [observed data](#). Only those points whose value is specified as observed for the selected data type will be shown in the plot. These plots are created in the *Plot Wizard* by setting the *Plot Type* to "Residual vs. Observed".

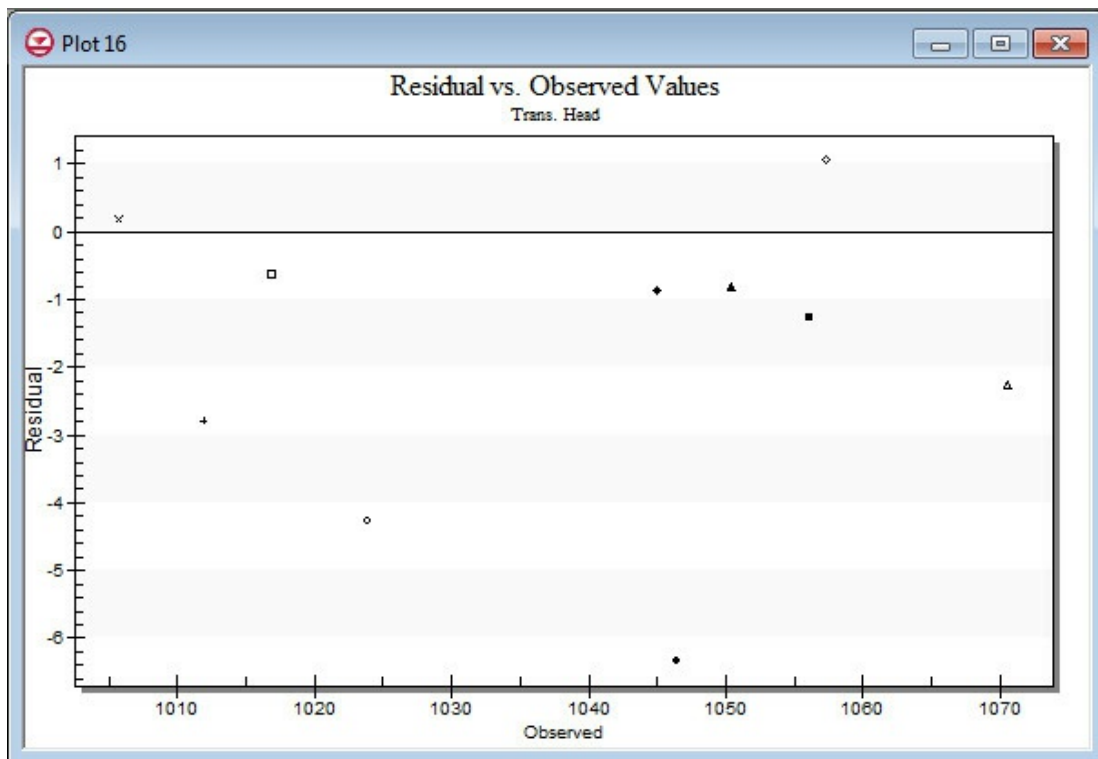

Residual vs. Observed Plot Options

After the plot type is set in the first page of the *Plot Wizard*, the **Next** button is clicked to open the *Residual vs. Observed Plot Options* wizard page. This page contains the following:

Coverage and Measurements

The observation coverage and measurements can be selected for each plot. If only one observation coverage and measurement exist these are used by default.

Use current solution

This option causes the plot to compare the observed values with the residual values of the current solution and time step for each observation point. When the active solution changes, the plot is recomputed and updated. If only one solution is in memory then this option is defaulted.

Use selected solutions

This option causes the plot to compare the observed values with the residual values of the specified solution for each observation point. Changing the active solution does not affect the plot.

Use time step

Because the plot shows only values from a specific time step, the active time step is used by default.

Residual vs. Observed (Weighted)

A Residual vs. Observed (Weighted) plot is used to display how well the entire set of weighted observed values match a model solution. On this plot is drawn a horizontal line along an error of zero, representing what would be a perfect correspondence between weighted observed data and solution values. One symbol is drawn for each observation point at the intersection of the weighted observed and residual (computed-observed) values for the point. This plot can show the trend of the solution values with regards to matching the [weighted observed data](#). Only those points whose value is specified as observed for the selected data type will be shown in the plot. This plot is not available with transient data. These plots are created in the *Plot Wizard* by setting the *Plot Type* to "Residual vs. Observed (Weighted)".

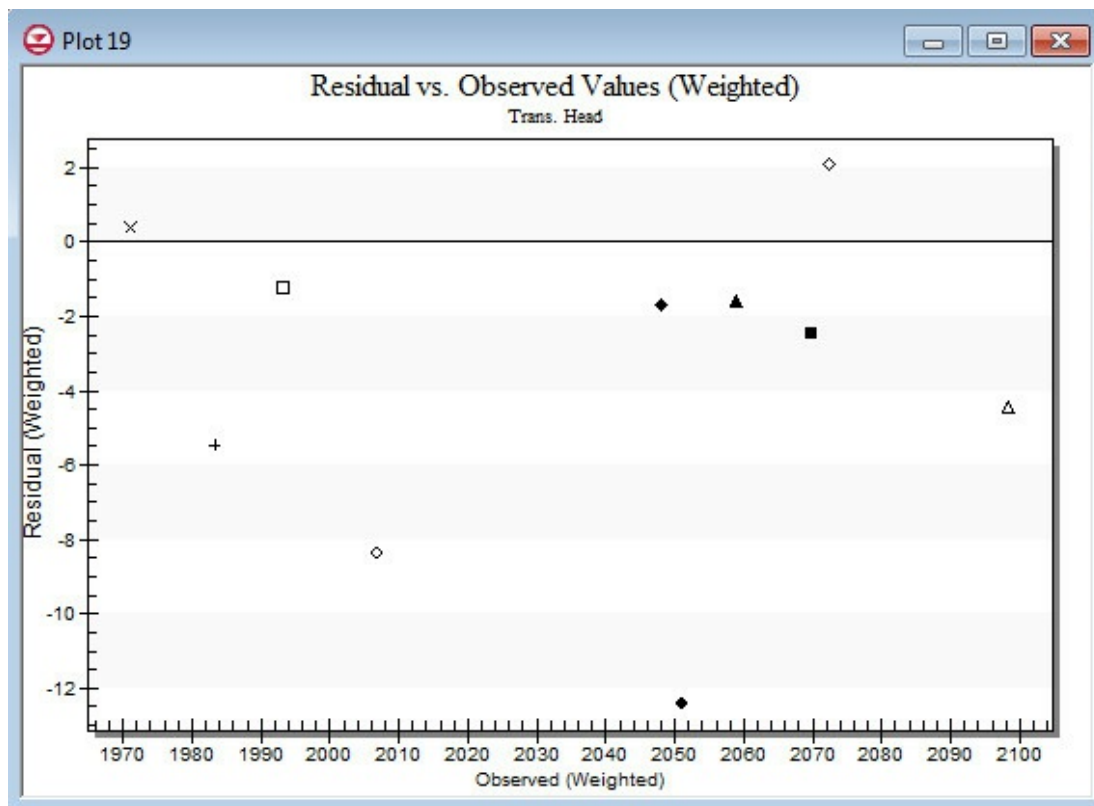

Residual vs. Observed Weighted Plot Options

After the plot type is set in the first page of the *Plot Wizard*, the **Next** button is clicked to open the *Residual vs. Observed (Weighted) Plot Options* wizard page. This page contains the following:

Coverage and Measurements

The observation coverage and measurements can be selected for each plot. If only one observation coverage and measurement exist these are used by default.

Use current solution

This option causes the plot to compare the weighted observed values with the residual values of the current solution and time step for each observation point. When the active solution changes, the plot is recomputed and updated. If only one solution is in memory then this option is defaulted.

Use selected solutions

This option causes the plot to compare the weighted observed values with the residual values of the specified solution for each observation point. Changing the active solution does not affect the plot.

Use time step

Because the plot shows only values from a specific time step, the active times step is used by default.

Parameter Sensitivity

A Parameter Sensitivity plot is used to display the sensitivity of the MODFLOW parameters. These plots are created in the *Plot Wizard* by setting the *Plot Type* to "Parameter Sensitivity".

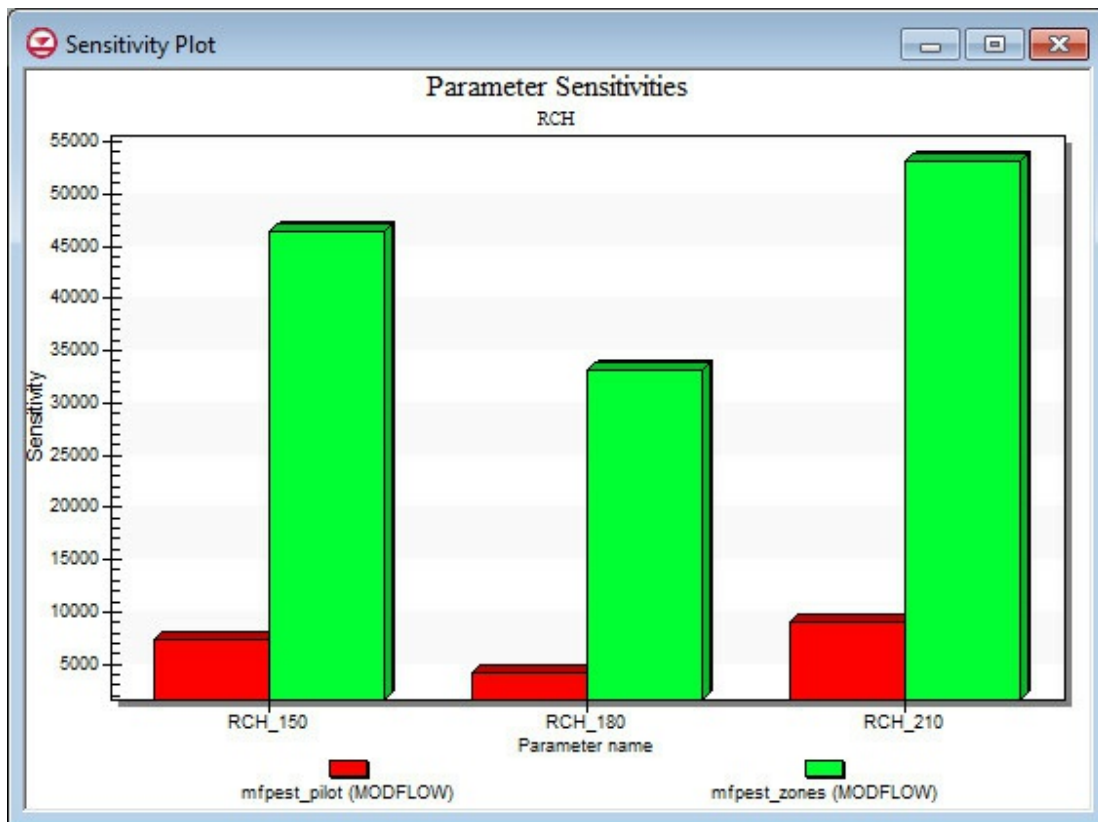

Parameter Sensitivity Plot Options

After the plot type is set in the first page of the *Plot Wizard*, the **Next** button is clicked to open the *Parameter Sensitivity Plot Options* wizard page. This page contains the following:

Parameter Type

This option changes the parameter type displayed.

Use current solution

This option causes the plot to compare parameter sensitivities of the current solution. When the active solution changes, the plot is recomputed and updated. If only one solution is in memory then this option is defaulted.

Use selected solutions

This option causes the plot to compare parameter sensitivities of the specified solution. Changing the active solution does not affect the plot.

Error vs. Simulation

An Error vs. Simulation plot is generally used with steady-state simulations and measurement types. It may be used in transient simulations. This plot can display the mean error, mean absolute error, and root mean squared error between successive solutions and

observed data. Various simulations would be run after changing model parameters, such as hydraulic conductivity or recharge. The plot will show trends in the solution to see if model parameter changes are causing better calibration with measured field data. Error vs. Simulation plots are created in the *Plot Wizard* by setting the *Plot Type* to "Error vs. Simulation".

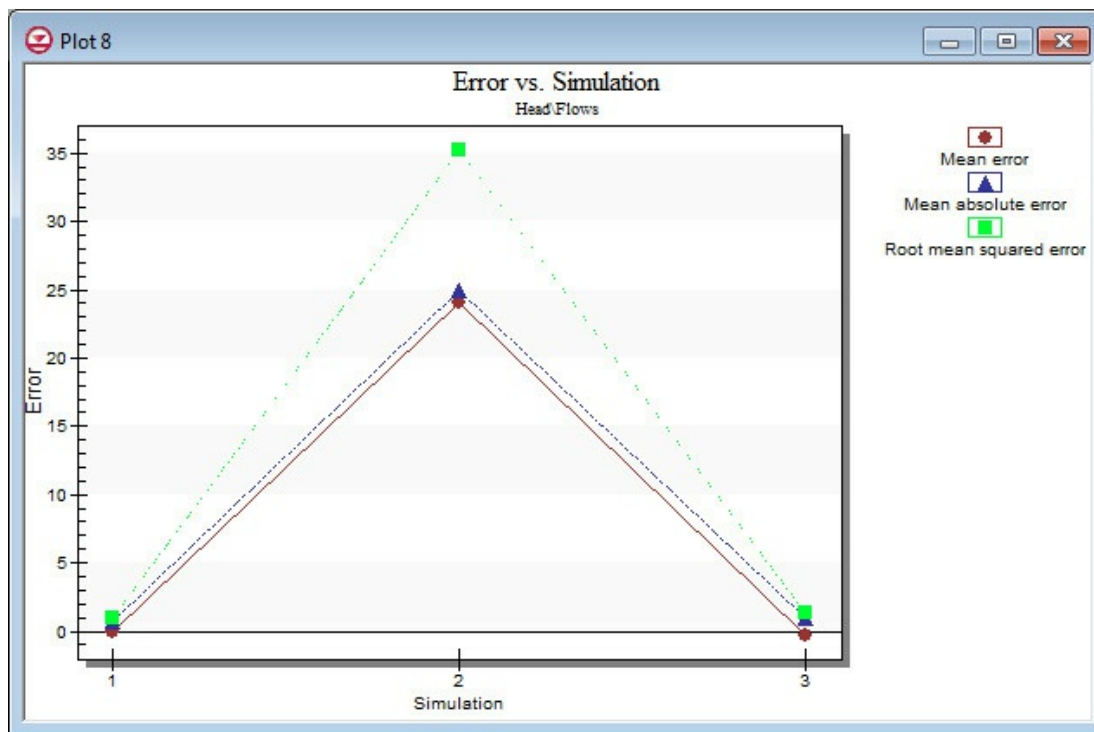

Error vs. Simulation Plot Options

After the plot type is set in the first page of the *Plot Wizard*, the **Next** button is clicked to open the *Error vs. Simulation Plot Options* wizard page. This page contains the following:

Solutions

This lists all available solutions.

Move Up/Move Down

GMS initially shows the solutions in the order they were opened. However, this is not necessarily the order in which they were run. To change the order, highlight a solution and move it up or down to rearrange their order.

Observed

This lists all available measurement types that were set up in the *Observation Coverage Options* dialog, both constant and transient. This plot is generally performed using constant solutions and measurement types, although transient data is allowed. Select in the combo box the measurement type that is being compared.

Check Box Options

There are three options that can be turned on or off. They determine whether the mean error, mean absolute error, and root mean squared error plots should be shown. Because these values are an average of all observation points, their line and symbol styles are not linked to any one observation point, but can be defined by clicking on the appropriate canvas window in the dialog.

Error vs. Time Step

An Error vs. Time Step plot is used with transient simulations to display the mean error, mean absolute error, and root mean squared error between a solution and observed data as a function of time. This plot applies to a single dataset in a model solution. Transient measurement types will show the average errors at each time step of the dataset. Error vs. Time Step plots are created in the *Plot Wizard* by setting the *Plot Type* to "Error vs. Time Step". A sample plot is shown in the figure.

Beginning with version 8.0, this plot can no longer be used with MODFLOW.

Error vs. Time Step Plot Options

After the plot type is set in the first page of the *Plot Wizard*, the **Next** button is clicked to open the *Error vs. Time Step Plot Options* wizard page. This page contains the following:

Use current solution

This option causes the plot to compare parameter sensitivities of the current solution. When the active solution changes, the plot is recomputed and updated. If only one solution is in memory then this option is defaulted.

Use selected solutions

This option causes the plot to compare parameter sensitivities of the specified solution. Changing the active solution does not affect the plot.

Observed

This lists all available measurement types that were set up in the *Observation Coverage Options* dialog, both constant and transient. A constant measurement should be used for solutions with only one time step, while a transient measurement should be used for transient solutions. Select the measurement type in the combo box that is being compared. If only one exists then it is used by default.

Check Box Options

There are three options that can be turned on or off. They determine whether the mean error, mean absolute error, and root mean squared error plots should be shown. Because these values are an average of all observation points, their line and symbol styles are not linked to any one observation point, but can be defined by

clicking on the appropriate canvas window in the dialog.

Error Summary

See the [Error Summary Plot](#) page for more details. An Error Summary plot is used to display the mean error, mean absolute error, and root mean squared error for a Solution. Error Summary plots are created in the *Plot Wizard* by setting the *Plot Type* to "Error Summary".

Beginning with version 8.0, this plot can no longer be used with MODFLOW. This information can be found by right-clicking on the MODFLOW solution in the Project Explorer.

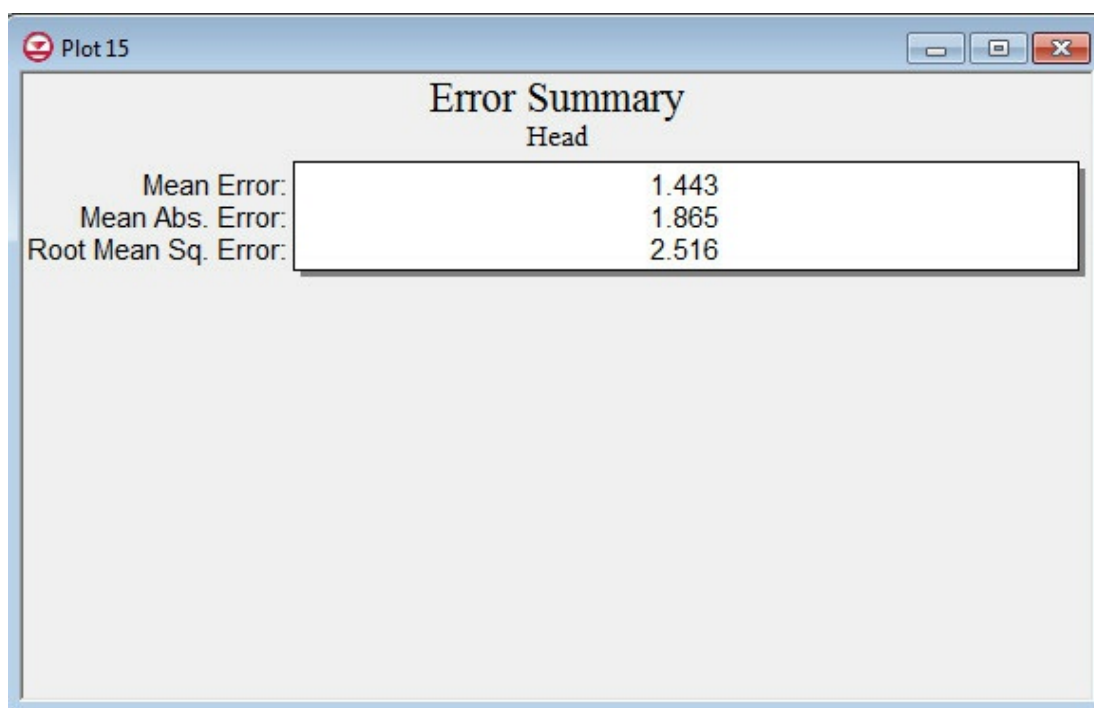

Error Summary Plot Options

After the plot type is set in the first page of the *Plot Wizard*, the **Next** button is clicked to open the *Error Summary Plot Options* wizard page. This page contains the following:

Use active solution

This option causes the plot to show a summary of mean error between the set of observed values with the values of the active solution for each observation point. When the active solution changes, the plot is recomputed and updated. This option is always on by default at this time

All time steps

This option shows the mean error for all time steps instead of only at the current or specified time step value.

Observed

This section shows the available list of observed values that were set up in the *Observation Coverage Options* dialog. Both constant and transient observed values should be available in this dialog.

Time Series

A Time Series plot is used to display the time variation of one or more scalar datasets associated to a given point inside a model solution. In addition, if transient calibration data has been defined, a band can be shown which represents a time variant [calibration target](#). Only transient datasets may be used in these plots. Time series plots are created in the *Plot Wizard* by setting the *Plot Type* to "Time Series". A sample plot is shown in the figure.

Beginning with version 8.0, these plots have been changed to show observation targets instead of a "band" around the observed data.

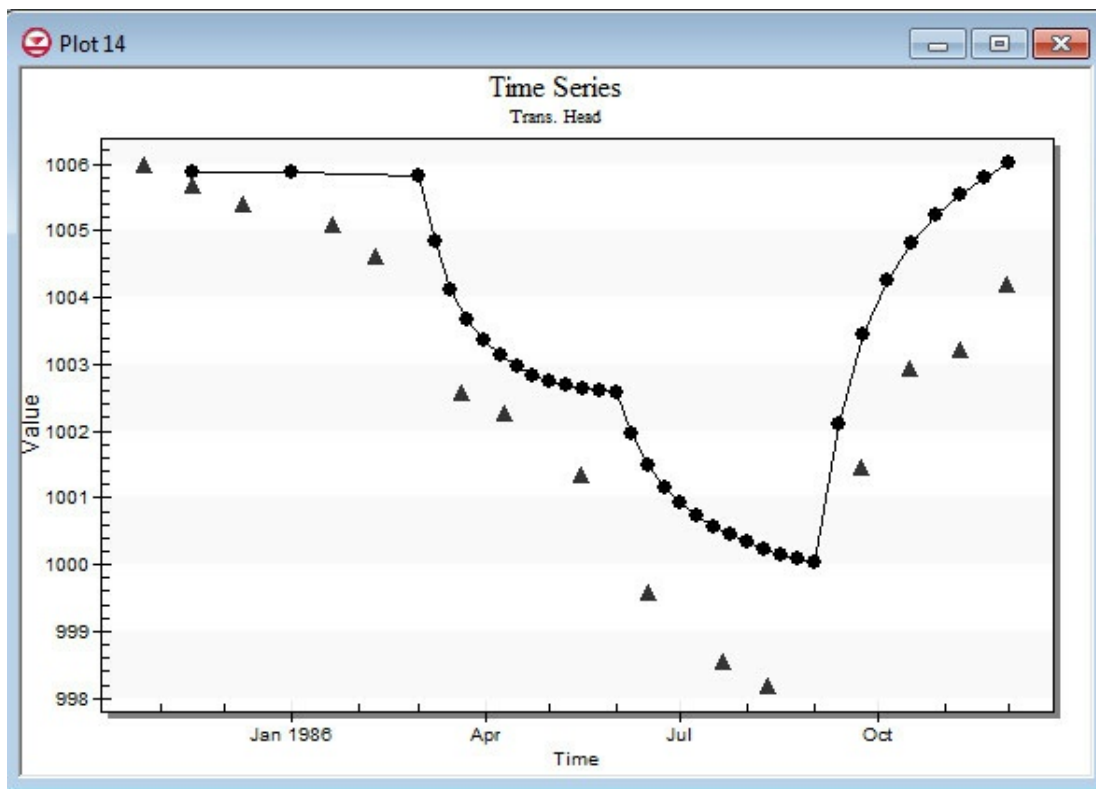

Time Series Plot Options

After the plot type is set in the first page of the *Plot Wizard*, the **Next** button is clicked to open the *Time Series Plot Options* wizard page. This page contains the following:

Coverage and Measurements

The observation coverage and measurements can be selected for each plot. If only one observation coverage and measurement exist these are used by default. *All Measurements* can also be selected to plot all of the different measurements on one plot.

Use current solution

This option causes the plot to display the values of the active Solution for each observation point being plotted. When the active solution changes, the plot is recomputed and updated. If only one solution is in memory then this option is defaulted.

Use selected solutions

This option causes the plot to display the values of one or more specified solutions for each point being plotted. Changing the active solution does not affect the plot.

Selected Points

Each of the observation points are shown in a spreadsheet. The show toggle determines which observation points will be displayed in a time series plot in the *Plot Window*. This way, only certain points are plotted in each individual time series plot. All the points can either be turned on or off by selecting the corresponding buttons below the spreadsheet.

Calibration Target

Turn this on to display a band in the plot to define the valid calibration range. If this is turned off, only the calibration curve will be drawn.

Time interval

A starting time and an ending time of observations can be specified by two combo boxes. Only the interval chosen will be shown on the time series plot.

Active Dataset Time Series

A Time Series plot is used to display the time variation of one or more scalar datasets associated to a given point selected in a model solution. Time series plots are created in the *Plot Wizard* by setting the *Plot Type* to "Active Dataset Time Series".

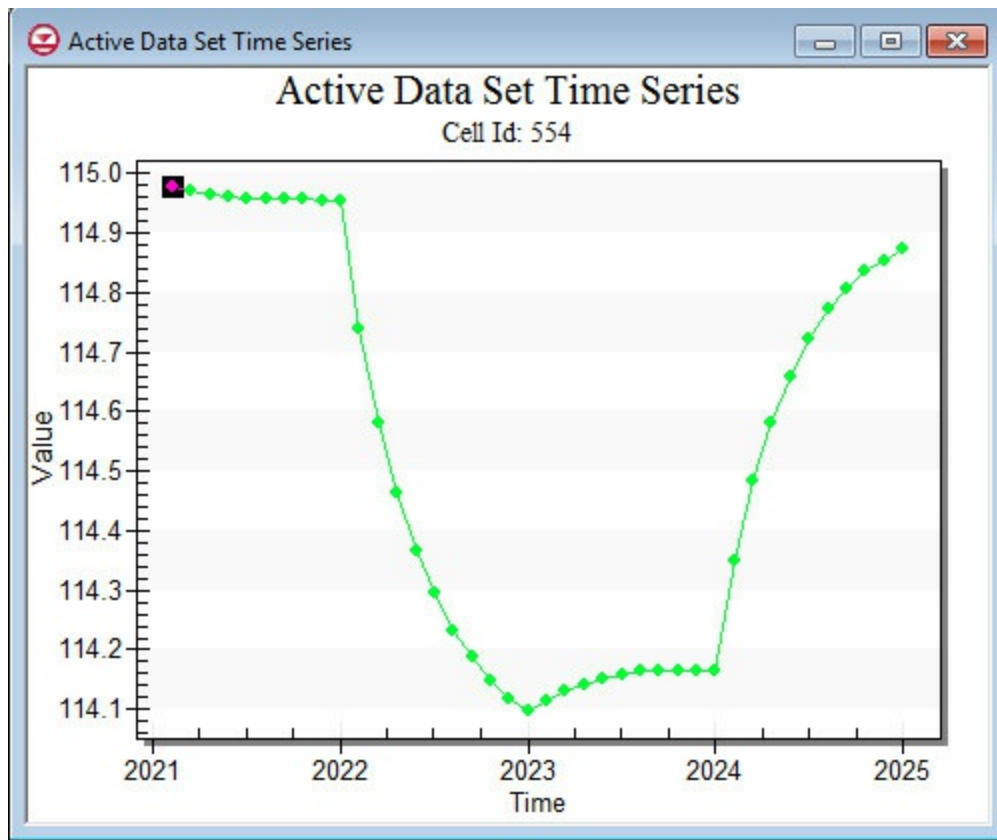

Active Dataset Time Series Plot Options

After the plot type is set in the first page of the *Plot Wizard*, the **Finish** button is clicked to create the active time series plot. For 2D and 3D grids select a grid cell and for 2D and 3D meshes select a node to display the scalar values of the dataset at that location over time. Select up to five locations to be plotted on one plot.

S/S Flow vs. Time

A flow vs. time plot is used to display the flow or water over time for a selected feature object or grid cell. Flow vs. time plots are created in the *Plot Wizard* by setting the *Plot Type* to *Flow vs. Time*.

S/S Flow vs. Time Plot Options

After the plot type is set in the first page of the *Plot Wizard*, the **Finish** button is clicked to create the flow vs time plot. This plot will report the flow either by selecting a feature object defined as a MODFLOW source/sink in the map module or by selecting a group of cells in the 3D grid. To change the plot options for the flow vs. time plot right-click on the plot and

select the **Plot Data** command. The *Plot Data* dialog contains the following:

Feature Objects flow

This option allows for selecting what data to plot when a source/sink feature object is selected in the Map module. By default the computed flow is plotted. If observed values exist for the feature object than those values can also be plotted along with calibration target ranges.

Grid Cell Flow

This option allows for selecting what Source/Sink flows to be plotted when grid cells are selected in the 3D grid module. The options are: *Storage*, *Constant Head*, *Drains*, *General Heads*, *Rivers*, *Streams*, *Recharge*, *Evapotranspiration*, and *Total Source/Sink* flow in and out of the cells.

Flow Budget vs. Time

A flow budget vs. time plot is used to display the flow or water over time for selected grid cell or for [zone budget ids](#). Flow budget vs. time plots are created in the *Plot Wizard* by setting the *Plot Type* to "Flow Budget vs. Time".

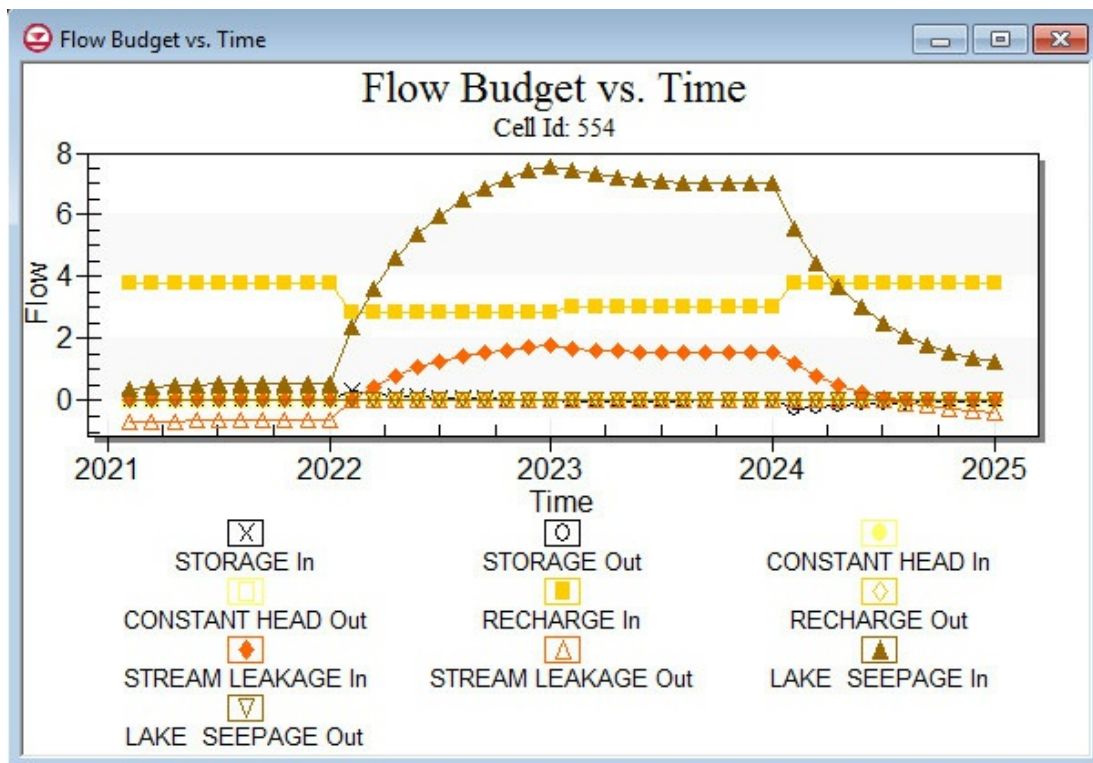

Flow Budget vs. Time Plot Options

After the plot type is set in the first page of the *Plot Wizard*, the **Next** button is clicked to

open the *Flow Budget Plot Options* wizard page. The options on this page are discussed below. The **Finish** button is clicked to create the flow budget vs time plot. This plot will report the flow either by selecting a group of cells in the 3D grid or by using the [zone budget ids](#).

Display using

This option allows users to determine the data to plot. The flow budget will be computed either from the selected 3D grid cells or from the selected [zone budget IDs](#) in the spreadsheet.

Grid Cell Flow

This option allows users to select what source/sink flows to be plotted. The options are: *Storage, Constant Head, Drains, General Heads, Rivers, Streams, Recharge, Evapotranspiration*, and *Total Source/Sink* flow in and out of the cells.

Gage Package Value vs. Time

This plot shows a time series for a single gage package column. After the plot type is set in the first page of the *Plot Wizard*, the **Next** button is clicked to open the *Gage Package Time Series* wizard page. To generate a gage plot the gage file needs to be selected from the list on the left, and the data column from the list on the right. If GMS is unable to properly read the data from the gage file, an error is shown in the wizard page to the right of the data column list.

Finish

When the **Finish** button is selected, a window is opened with the plot. Plot windows are created each time the *Plot Wizard* is run. See the 2D plots discussion for information on editing plots that have been created.

Right-Click Menu Commands

Once the plot has been created, the appearance and data of the plot can be altered with commands accessed by right-clicking on the plot window. The commands available through the right-click menu are described below.

Plot Data

Brings up the second step of the plot wizard where the attributes of each plot are set.

The plot data can be updated based upon the type of plot. For histogram plots, it brings up a dialog used to edit the precision displayed on the plot.

Display Options

Allows changing general display attributes of the plot (border style, precision, axis type, fonts, colors, etc.).

Axis Titles

Used to change the x and y axis titles.

Set As Display Defaults

Saves the plots current settings as the default settings.

Legends

Submenu that allows selecting the legend location. The maximum number of points included in the legend depends upon the size of the plot window.

Export/Print

Brings up a dialog is showing options for printing or exporting the plots values.

Default Display

Saves the plot's current settings as the default settings.

View Values

Brings up a spreadsheet containing the data points associated with the current plot.

See also

- [Display Options](#)
- [Model Calibration](#)

Calibration Targets

An observed value can be assigned to **feature objects**: points, arcs, arc groups and polygons in a coverage. Observation properties are edited in the **Coverage Setup** dialog. The figure shows the **Coverage Setup** dialog. Point observation properties are edited under the green highlighted section and flow observation properties are edited under the purple highlighted section.

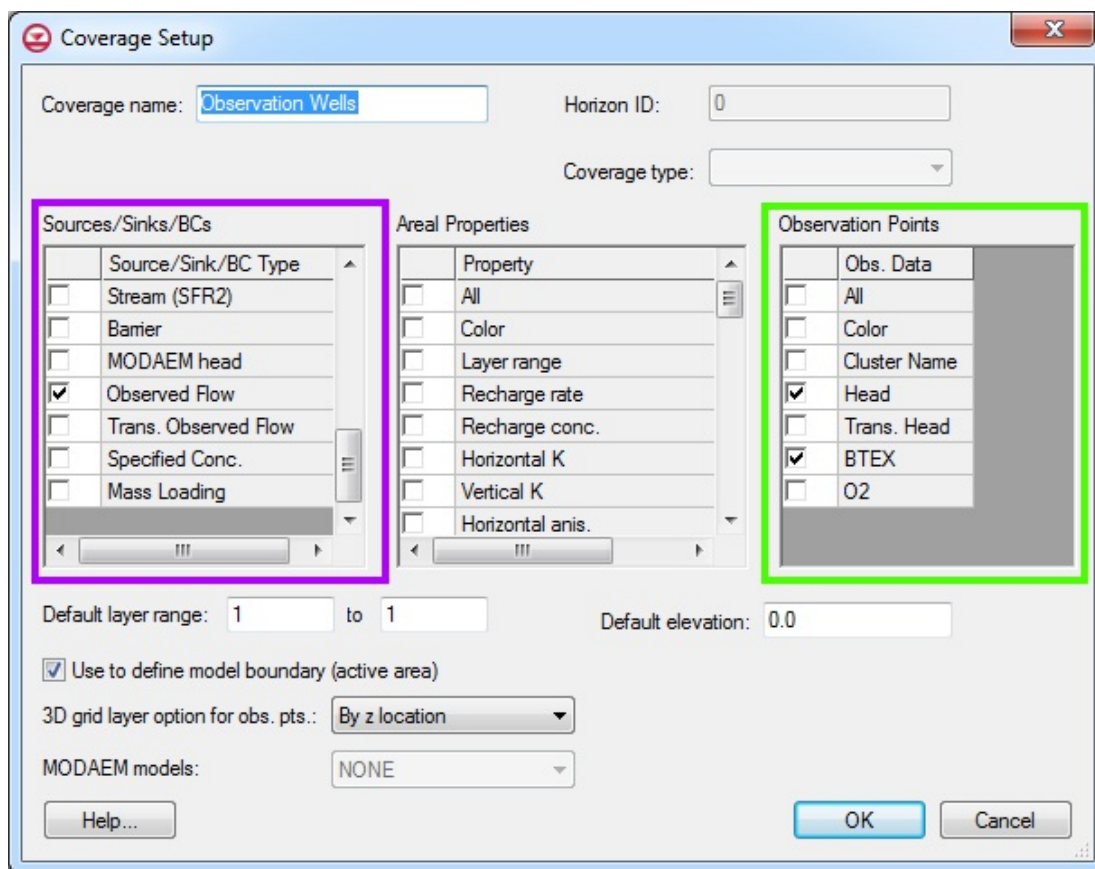

Coverage Setup dialog

If an observed value has been assigned to a feature object, the calibration error at each object can be plotted using a "calibration target". A set of calibration targets provides useful feedback on the magnitude, direction (high, low), and spatial distribution of the calibration error. The components of a calibration target are illustrated in the following figure. The center of the target corresponds to the observed value. The top of the target corresponds to the observed value plus the interval and the bottom corresponds to the observed value

minus the interval. The colored bar represents the error. If the bar lies entirely within the target, the color bar is drawn in green. If the bar is outside the target, but the error is less than 200%, the bar is drawn in yellow. If the error is greater than 200%, the bar is drawn in red. The display options related to calibration targets are specified in the [Feature Object Display Options](#) dialog.

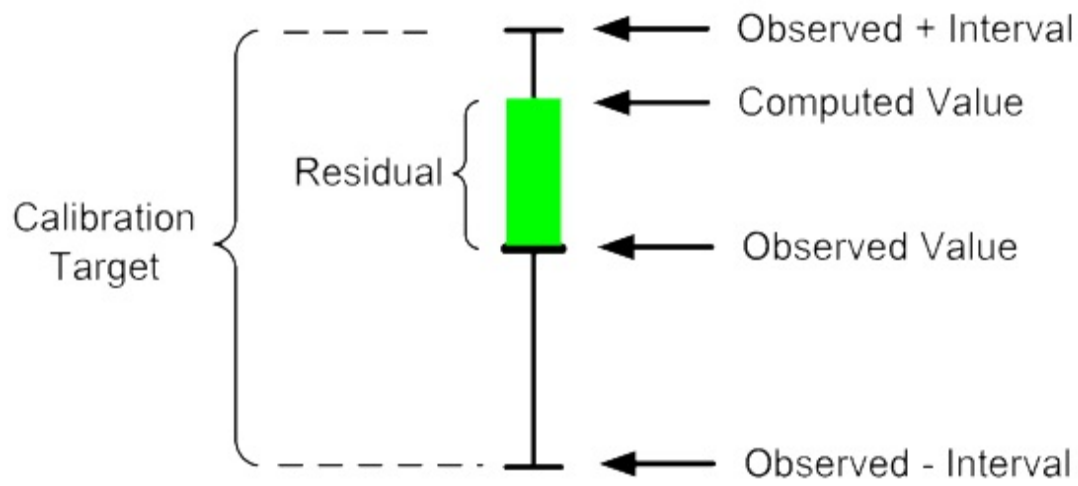

Example of a calibration target

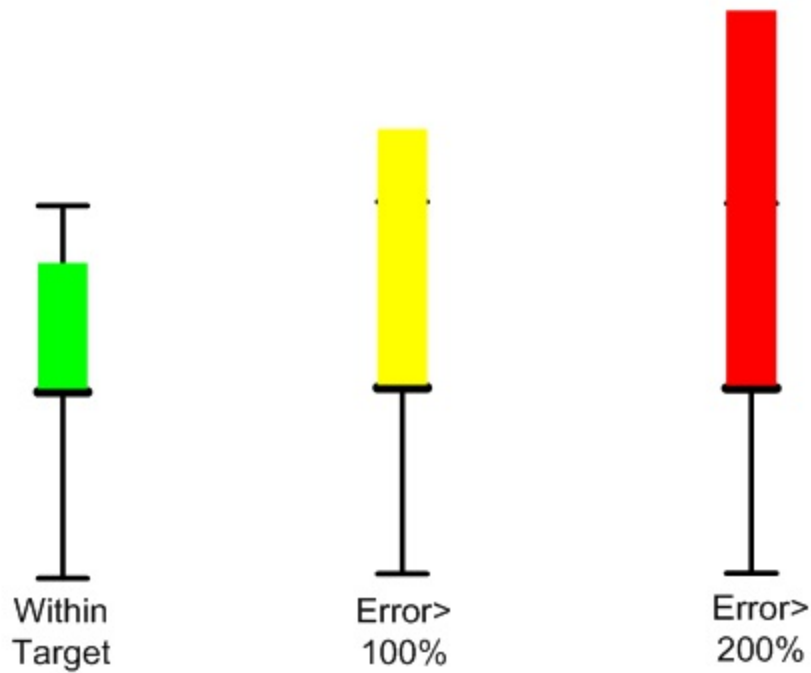

Observation target error bars

GMS also supports transient observation data. Often, the measured times of the field observations do not match the output times of the model. When this occurs GMS will linearly interpolate the observed value at the model output time in order to display an observation target. If the model output time is before the first observed time or after the last observed time then the target is drawn in a "washed out" (or lighter) color for that particular observation.



Transient observations

See also

- [Model Calibration](#)

Model Checker

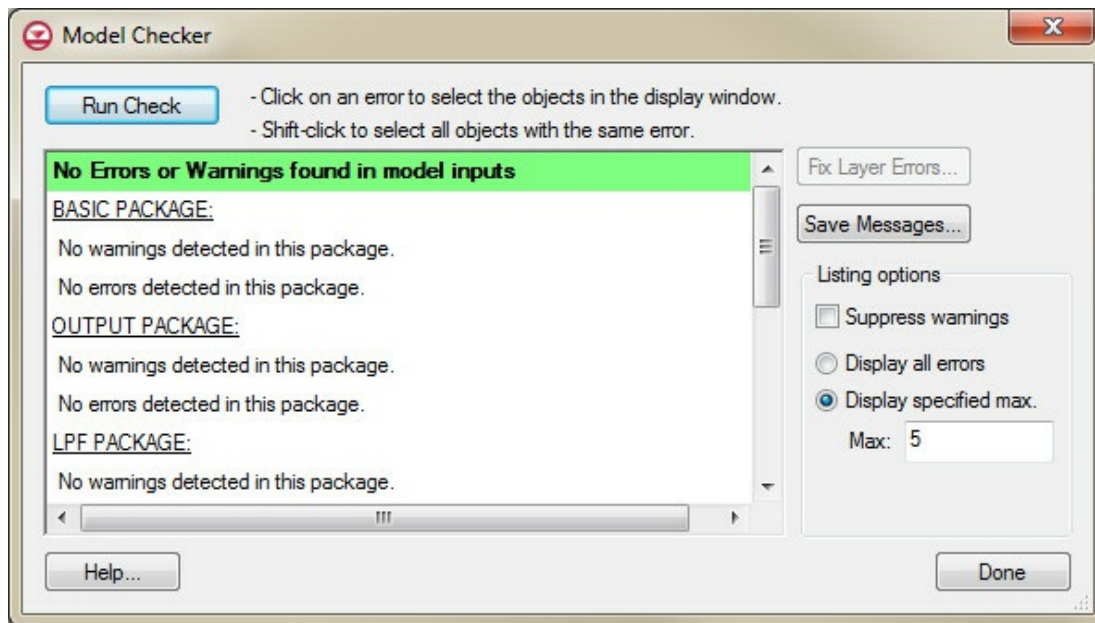

Example of the Model Checker dialog in GMS.

Once a mesh or grid is generated and all of the analysis options and boundary conditions have been specified, the next step is to save the simulation to disk and run the model. However, before saving the simulation and running the model, the model should be checked with the *Model Checker*. Because of the significant amount of data required for a simulation for all the different models, it is often easy to neglect important data or to define inconsistent or incompatible options and parameters. Such errors will either cause the model to crash or to generate an erroneous solution. The purpose of the *Model Checker* is to analyze the input data currently defined for a model simulation and report any obvious errors or potential problems. Running the *Model Checker* successfully does not guarantee that a solution will be correct. It simply serves as an initial check on the input data and can save a considerable amount of time that would otherwise be lost tracking down input errors.

Running the Model Checker

To check the current data, select the **Check Simulation** command from the "current model" menu. The *Model Checker* dialog will appear. To run the *Model Checker*, select the button

labeled **Run Check** at the top of the dialog. This generates a list of possible errors and warning messages in the top scrolling window.

If the model checker finds any potential errors with the input, then fix the errors and rerun the model checker.

Options

The **Checker Options** button in the *Model Checker* allows customizing the checks that will be performed. A check box is provided for each category of the model input data. Turning off any of the options will suppress the warnings and errors associated with these categories. Also provided is the option to define the maximum number of errors and warnings to be reported of the same type. Messages classified as warnings can also be suppressed.

Save Messages

The **Save Messages** button provides the option to save the current listing of warnings and error messages to a text file.

Fix Layer Errors

One unique feature of the MODFLOW *Model Checker* is the **Fix Layer Errors** option.

7.2. Parameters

Parameters

A parameter is a variable that is used to control one or more other values. GMS uses parameters with [MODFLOW](#) to define inputs for [forward runs](#) or for [model calibration](#) or for [stochastic modeling](#).

Key value and standard MODFLOW parameters

There are two ways to do MODFLOW parameterization in GMS:

- The [key value method](#) (recommended)
- The [standard MODFLOW method](#)

Key values

Key values are used to parameterize the MODFLOW input. Key values can be used for both the zonation and pilot points methods of defining parameters. A key value is a number that is assigned as input that marks the input values as belonging to a parameter. When selecting a key value, a number should be chosen that is not likely to occur in typical input for that parameter. We recommend using negative numbers in most cases.

For example, a model may have four *K* zones and three recharge zones. The four *K* zones would be marked by assigning -100, -200, -300, and -400 to the cells in the *K* array for each of the four zones. Likewise, the recharge zones would be marked by assigning -500, -600, and -700 to the appropriate cells in the recharge array.

Key values can be assigned either by editing the cell array values directly in the 3D grid module or by assigning the values to a set of [polygons or arcs](#) in the [conceptual model](#) and selecting the **Map → MODFLOW** command.

When MODFLOW is running and data is read from the [HDF5](#) file, if one of the parameter key values is found in the data then the parameter value is substituted into the array or list.

The key value approach makes it much easier to support transient parameters and very

large sets of pilot points. Also, this approach allows GMS users to use parameters with the BCF package. This feature is not available with the MODFLOW PES process.

Standard MODFLOW parameters

The "key value" approach is the preferred approach to defining parameters in GMS. Using key values is the only option for WEL, RIV, DRT, DRN, GHB, CHD, STR, and HFB parameters. In GMS, using the key value approach with these parameters provides the same functionality of parameter instances available in MODFLOW.

Key values can also be used with array based parameters. However, GMS does support defining array based parameters with clusters and instances (for ETS, EVT, RCH parameters).

When reading in a MODFLOW simulation that was created outside of GMS all parameters will be converted to key values so long as the parameter can be represented by key values.

Key values can not be used to represent an array based parameter if the parameter is defined using more than one cluster or more than one instance. Also, if more than one parameter uses the same zone array with a matching IZ value then the parameter can not be represented using key values. Further, if the multiplier array associated with the parameter has values other than 1.0 in the zones where the parameter is used then the parameter can not be represented with key values.

The [standard MODFLOW method](#) is considered an "advanced" feature in GMS. ***Only users that understand how MODFLOW uses parameters should attempt to use this feature.***

For more information, refer to the [Standard MODFLOW Parameters](#) page.

Using parameters

To use parameters:

1. [Parameterize the model](#) and
2. [Create a parameter list](#)

Parameterizing the model

There are two methods used to parameterize a model:

- [Zonation](#)
- [Pilot Points](#)

Zonation

The most common form of parameterization is zonation. With this approach, an array of input values is divided into zones where all of the cells in each zone share a single parameter value. This concept is illustrated in the figure below. The entire array of values is represented by three parameters.

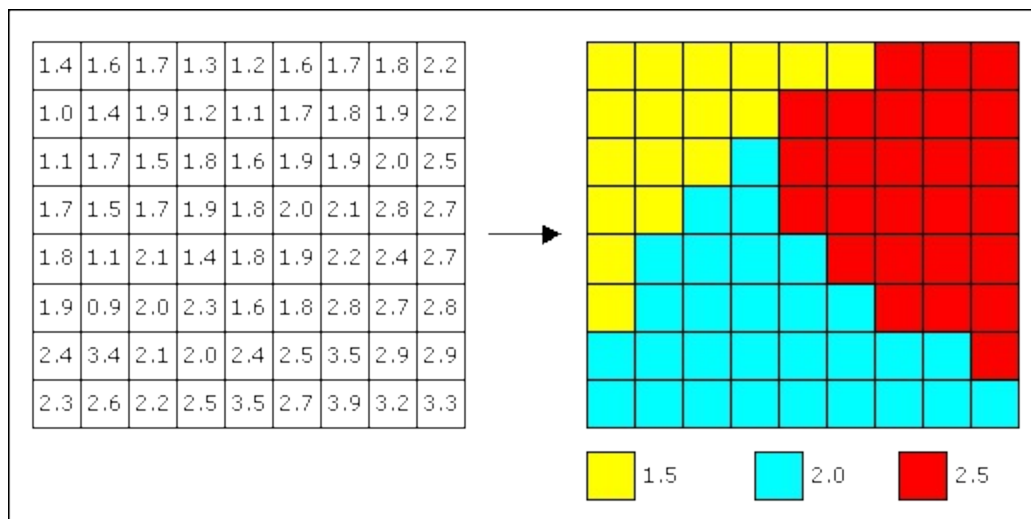

Zonation is most easily accomplished in GMS by assigning key values to polygons in the map module. It can also be accomplished by assigning key values to a selected set of cells in the 3D grid module using the [Cell Attributes](#) command.

Pilot points

Another way to parameterize a model is to use pilot points. For more information on pilot points, refer to the [Pilot Points](#) page.

Creating a parameter list

The list of parameters is defined using the [Parameter dialog](#). In general, the number of parameters should be less than the number of observations. However, if the user chooses to use [pilot points](#) with PEST in regularization mode, then the number of parameters does not have to be less than the number of observations.

Legal MODFLOW parameters

The following MODFLOW input values can be defined as parameters in GMS:

Package	Option
LPF/HUF	<ul style="list-style-type: none"> • HK – Horiz. hydraulic conductivity • HANI – Horiz. anisotropy • VK – Vert. hydraulic conductivity • VKCB – Vert. hydraulic conductivity of confining beds • VANI – Vert. anisotropy • SS – Specific storage • SY – Specific yield
Recharge	RCH – Recharge value
Evapotranspiration	EVT – Max ET flux
Evapotranspiration Segments	ETS – Max ET flux
Well	WELL – Pumping rate
River	RIV – River conductance
General Head	GHB – Conductance
Drain	DRN – Conductance
Time-Variant Specified-Head	CHD – Head
Stream	STR – Conductance
Stream-flow Routing	SFR – Conductance
Horizontal Flow Barrier	HFB – Hydraulic characteristic

Parameter Dialog

When building a MODFLOW [inverse model](#), the input data must be parameterized. This is accomplished by assigning a set of key values to selected input fields. Once the key values are assigned, the next step is to create a parameter list.

Parameters can also be used to perform forward runs.

See also [Standard MODFLOW Parameters](#).

Creating/Deleting Parameters

The *Parameters* dialog (accessed through the *MODFLOW* menu using the **Parameters** command) contains the list of parameters. A new parameter can be created by selecting the **New Parameter** button. Each parameter that is defined should correspond to a key value that has been defined in the MODFLOW input. A parameter can be removed from the list by selecting the parameter and selecting the **Delete Parameter** button. The entire list of parameters can be deleted by selecting the **Delete All** button.

Initialize from Model

In most cases, the fastest and simplest way to create the parameter list is to use the **Initialize from Model** button. When this button is selected, GMS traverses the MODFLOW input data corresponding to legal parameter values and searches for key values. It is assumed that the key values are entered as negative numbers. When a unique negative number is found, a new parameter is added to the list, and a default name is given to the parameter based on the parameter type.

NOTE: The **Initialize from Model** command will not search for key values in the Well package. This is because negative pumping rates are perfectly common and do not necessarily correspond to key values. If wanting to define a well Q as a parameter, use the **New Parameter** button and manually create the parameter.

Import Optimal Values

After performing an inverse model run, the inverse code writes out a text file containing the set of optimal parameter values corresponding to the minimum calibration error. The next step is to read these values into GMS. This is accomplished by selecting the **Import Optimal Values** button. Once the file is opened, the optimal parameter values will be loaded into the starting value field and displayed in the parameter list.

If any of the parameters use pilot points, importing the optimal values will also import and create a new dataset for the associated 2D scatter point set.

Spreadsheet

The spreadsheet holds parameters, their types, starting and bounding values and other options that depend on the packages and [run options](#) defined for the current MODFLOW simulation in the [Global Options\Basic Package](#).

Parameter Estimation Solve

Toggle on this option to solve for the optimal parameter value using a parameter estimation program like PEST. (See [Automated Parameter Estimation](#))

Name

The name must be unique and limited to 8 characters. The default name should be sufficient. This name will be used to reference the parameter in the MODFLOW solution and output files.

Key

The key value, usually a negative value, must be unique and is used to link the parameter with the data in the MODFLOW input files. The key value should also be entered into the MODFLOW data by directly entering the values using the grid based approach or by using the map module.

Type

GMS supports most of the parameter types that are also supported by the MODFLOW PES process.

Start Value/Pilot Points

This value will be the starting value for inverse modeling, the mean value for stochastic modeling, or the substitute value for forward runs.

For inverse modeling, the closer the starting value is to the "optimal" value, the better the odds that the inverse model will converge and the less time it will take to converge. It is generally not a good idea to give all parameters of a given type (e.g., recharge) a constant value and let the inverse model start from that point. Ideally, field tests, soil types, ground cover, and sound modeling judgement can provide a good set of starting values. It is also a good idea to undergo some manual trial-and-error calibration prior to setting up the inverse code.

[Pilot points](#) can be used to define a parameter by selecting the drop-down arrow in this column and selecting the *Pilot points* option. Pilot points are an alternative to using zonation to define parameter locations. When using pilot points, using the **Pilot Point Options** button to choose a 2D point scatter point set and choose the appropriate interpolation options.

Min Value Max Value

The min and max values will provide the bounds for the parameter, and they must encompass the starting value. The parameter values will be forced between these values during inverse and stochastic modeling. In these cases, the min and max values are just "suggestions" and are used to predict parameter values.

When selecting the min and max values for the parameters, care should be taken not to make the range in values too large. Inverse models are highly sensitive to the stability of the underlying model. If MODFLOW does not converge, the inverse model will not be able to find a solution. Furthermore, excessive cell drying can cause the inverse model to fail to converge. If the min and/or max values are too extreme, the odds of the MODFLOW model not converging or excessive numbers of cells going dry increases. It is best to select a limited range for each parameter and then to compare the final optimal parameter value to this range. If the optimal value is at either the min or max of the range, the range can be

adjusted and the inverse model can be re-launched.

Log xform

This option log transforms the value during prediction process of inverse modeling and the random number generation process of stochastic modeling. The best parameters to log transform are those that can vary by orders of magnitude like hydraulic conductivity.

It is also recommended to log transform recharge parameters if using pilot points for hydraulic conductivity and the hydraulic conductivity parameter is log transformed.

BSCAL

MODFLOW documentation includes:

This value is an alternate scaling factor for the parameter, and always needs to be a positive number. If the parameter value becomes 0.0, which can occur for parameters that are not log transformed, BSCAL is used in the scaling. If the absolute value of the parameter is less than BSCAL, BSCAL is used in the scaling. The best value to use is problem dependant. Good choices are the smallest reasonable value of the parameter or a value two to three orders of magnitude smaller than the value specified by the starting value. If the smallest reasonable value is 0.0, a reasonable non-zero value needs to be used. BSCAL has no effect on the scaled sensitivities for log-transformed parameters.

Multiplier

Select this option to include a multiplier array for RCH and HK parameters.

Dataset / Folder

Use this button to select a multiplier array of a set of multiplier arrays (stochastic only) by selecting a folder of datasets.

Stochastic Options

Standard Deviation

Use this field to specify the standard deviation of a parameter for a stochastic simulation.

Mean value

Use this field to specify the mean of a parameter for a stochastic simulation.

Distribution

When the parameter is stochastic, use this option to choose between a normal or linear distribution. A random number for the parameter is generated using the distribution, the mean value (starting value) and the standard deviation.

Std Deviation

The standard deviation is used for a stochastic parameter to generate a random number using the chosen distribution.

Num Segments

When the parameter is stochastic and the stochastic method is Latin Hypercube, the number of segments helps determine how many total MODFLOW runs will be used.

See also

- [MODFLOW Run Options](#)

Pilot Points

Pilot points can be thought of as a 2D scatter point set. Instead of creating a zone and having the inverse model estimate one value for the entire zone, the value of the parameter within the zone is interpolated from the pilot points. Then the inverse model estimates the values at the pilot points. The figure below shows a set of pilot points used to estimate horizontal hydraulic conductivity. Notice how the hydraulic conductivity now varies from cell to cell. When the inverse model runs, the values at the pilot points are adjusted and the “surface” defining the variation of K values is warped until the objective function is minimized.

PEST provides an additional option for the pilot point method called “regularization”. Regularization imposes an additional measure of “stiffness” to the parameter being interpolated via a “homogeneity” constraint. In the absence of any strong influence from the PEST objective function, this constraint causes values at pilot points to approximate the mean value of adjacent pilot points. This constraint makes the inversion process much more stable and makes it possible to violate one of the typical constraints associated with parameter estimation: namely, the requirement that the number of parameters must be less than the number of observations. With regularization, the number of parameters can greatly exceed the number of observations. As a result, complex hydraulic conductivity distributions can be defined, resulting in extremely low residual error. The pilot point method with regularization is an incredibly powerful feature of PEST. (For more on PEST see [Automated Parameter Estimation](#))

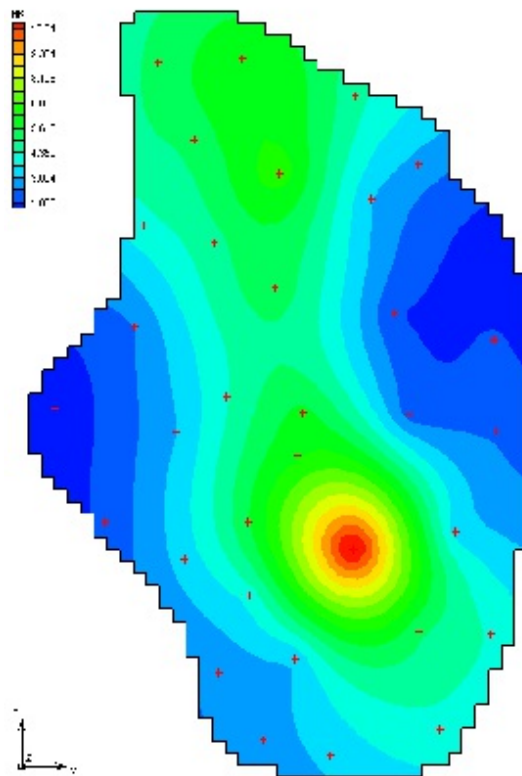

Pilot points and resulting conductivity field

Interpolation Options

Kriging and **IDW** are the only interpolation options supported with pilot points. The kriging option requires the establishment of a model variogram (by creating a nested structure). The nodal function options in the IDW method are not supported because those schemes compute gradients based on the dataset values at the surrounding points. With the pilot point method, the values at the points will change during the inversion process, thereby rendering the previously computed gradients inaccurate.

Pilot Point Conditioning

For pilot point interpolation of hydraulic conductivity, it is sometimes useful to include one or more measured K values with the pilot point set. These measured values could represent K values extracted from a field pump test. The *Pilot Point Conditioning* option is available to represent this scenario. One of the properties associated with scatter points is a *Fixed pilot*

point toggle. If this toggle is on and the corresponding scatter point set is used for pilot point interpolation, the K value assigned to the point is not allowed to vary during the parameter estimation process.

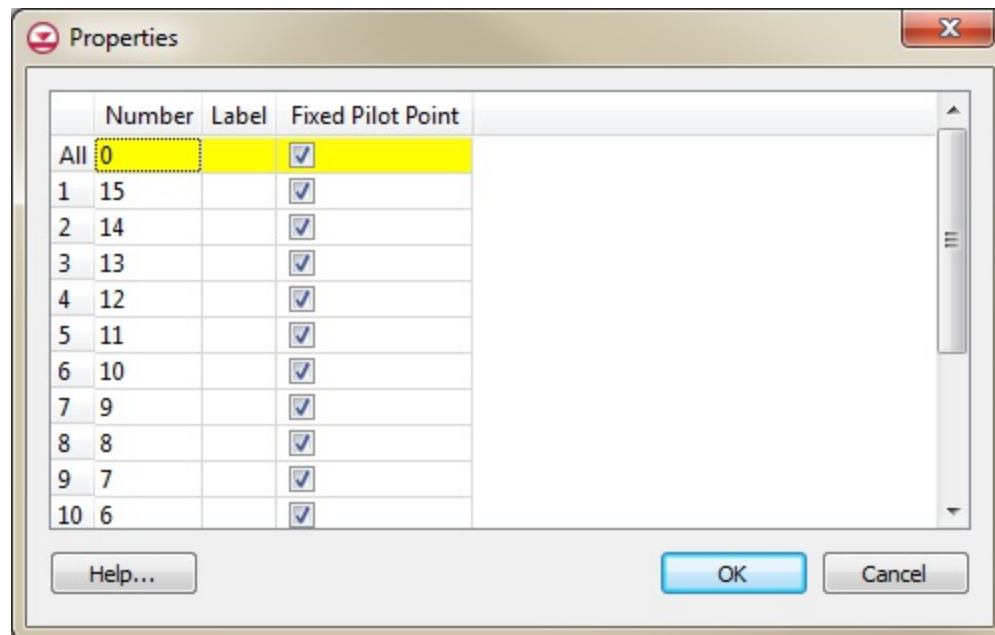

Guidelines for Placement of Pilot Points

Note: The recommended maximum number of pilot points is about 200.

1. Place points between observations rather than on top of observations
2. Add greater density where there are more observations
3. Add points where head gradient is steep
4. Place a row of points between observation wells and head-dependent boundaries
5. Fill in the gaps

See also

- [Model Calibration](#)

Multiplier Arrays for Parameters

HK and RCH parameters may be associated with a multiplier array. A dataset is associated with a parameter zone and the starting parameter value is multiplied by the dataset to define the spatial variation of the parameter throughout the zone.

Setting up Multiplier Arrays

The multiplier dataset is associated with the parameter zone in the *Parameters* dialog by first turning on the *Use multiplier arrays* toggle, selecting either *Single Array* or *Multiple Array* from the pull-down list in the *Multiplier* column, and then selecting the dataset using the button in the *Dataset/Folder* column. If the *Single Array* option is selected, a single dataset should be selected in the *Dataset/Folder* column. If the *Multiple Array* option is selected, an entire folder of datasets should be selected. The *Multiple Array* option is only available for stochastic modeling.

If the *Single Array* option is selected the array for the parameter will be defined as the starting/mean value multiplied by the multiplication array for all cells associated with the parameter. Multiplier arrays are not available for parameters that use pilot points.

When the *Multiple Arrays* option is selected, the number of stochastic model runs will be a function of how many datasets are in the folder selected by the user for the multipliers.

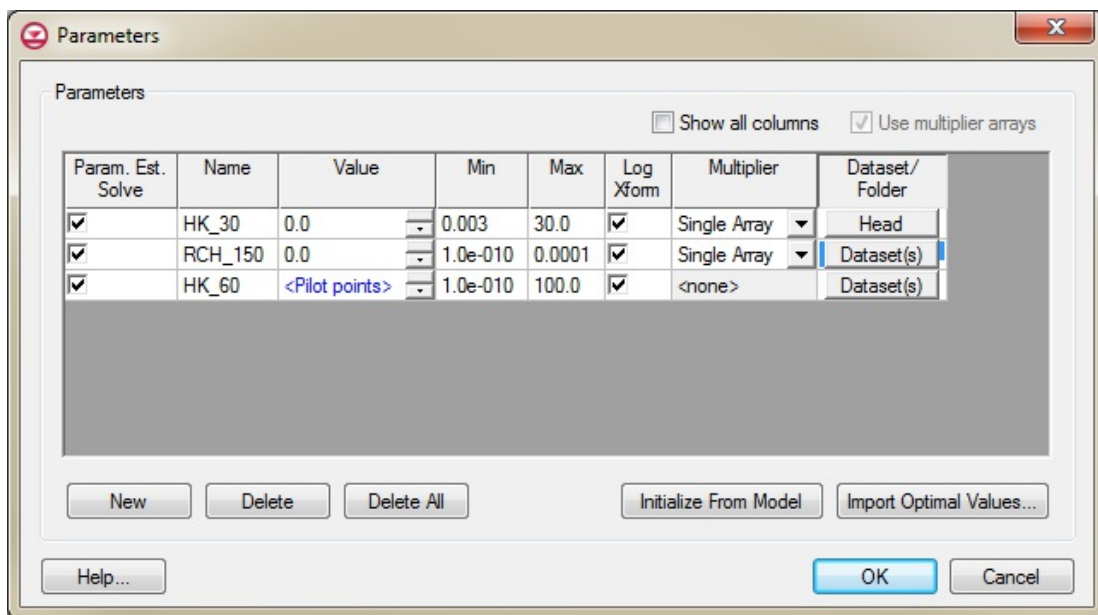

The Parameters dialog showing the Multiple Arrays option

Guassian Field Based Monte Carlo Simulations

The *Multiple Array* option for user-defined multiplier arrays can be used in combination with the new [Gaussian Field Generator](#) to perform a Monte Carlo simulation. This is accomplished by first generating a set of Gaussian fields using the FIELDGEN code and then associating the resulting folder of datasets with a parameter as described above. A stochastic simulation can then be performed using the Parameter Randomization method. For each model instance, GMS loads a new instance of the multiplier array into the model input. A default parameter value of 1.0 is generally recommended in such instances.

7.3. Stochastic Modeling

Stochastic Modeling

There are three methods in GMS for stochastic modeling using MODFLOW 2000 or 2005. The first, [parameter zonation](#), uses either a [random sampling](#), a [Latin hypercube sampling](#), or [Gaussian fields](#) to generate the different realizations. The second approach uses [indicator simulations](#) generated by [T-PROGS](#). The third, the Null Space Monte Carlo (NSMC) method, generates multiple generated models with different sets of parameters (in GMS 9.0 and after).

After the stochastic simulation results are generated, a user can view these results using the [Project Explorer](#). A user can also refine the results by using the [Risk Analysis Wizard](#) or [statistical analysis of stochastic solutions](#).

The stochastic modeling options can be added to a [paid edition](#) of GMS.

Stochastic Applications

One approach for dealing with model heterogeneity is stochastic simulations based on multiple equally plausible candidate realizations of the site heterogeneity. Ideally, such an approach would enable the generation of variability in subsurface soil stratigraphy based on interpretable geologic parameters such as lens width, material proportions, juxtapositioning tendencies and anisotropy. Multiple realizations that are conditioned to borehole data provide modelers with a rational approach for dealing with uncertainty associated with site characterization. Stochastic simulations can be applied to regional representations of the aquifer behavior in addition to local scale simulations. Stochastic simulations are particularly well-suited to local scale models since the resulting complex heterogeneity is more representative of actual stratigraphic deposition. This heterogeneity makes realistic and potentially more accurate contaminant transport simulation possible by simulating the preferential flow channels resulting from thin lenses of clays, sands, or other materials. The ultimate result of a stochastic approach is multiple simulations of hydraulic parameters that create a probabilistic solution. Such a solution has more credence and provides a better understanding of actual site conditions.

The ultimate application of T-PROGS is to generate stochastic simulations of soil heterogeneity. These realizations can then be incorporated into MODFLOW simulations as "material sets" in the [LPF package](#) or as "HUF data" in the [HUF package](#). (See [T-PROGS](#))

Stochastic Options Dialog

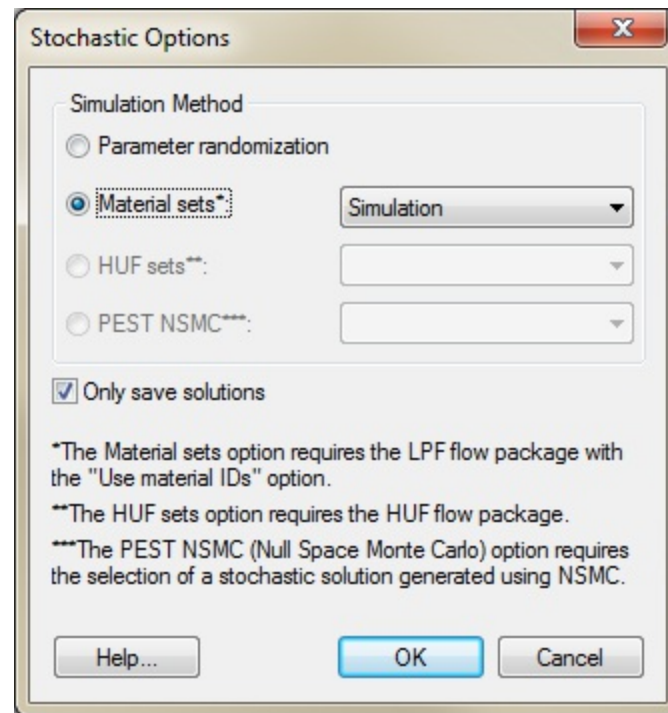

The Stochastic Options dialog

Use the *Stochastic Options* dialog to select the type of stochastic simulation its major options. The dialog is reached through the *MODFLOW* | **Stochastic** menu command.

Parameter Randomization

This option uses parameters defined in *Parameters* Dialog.

Material Sets

This option becomes available when there is at least one material set simulation in memory. One method for creating material sets is to use [T-PROGS](#). When this stochastic option is chosen, MODFLOW will be run once for each material set. This option also requires that the LPF package and the material IDs option be chosen.

HUF Sets

This option becomes available when there is at least one HUF set simulation in memory. One method for creating HUF sets is to use [T-PROGS](#). When this stochastic option is chosen, MODFLOW will be run once for each HUF set. This option also requires that the HUF package be chosen.

PEST NSMC

In order to use the Null Space Monte Carlo method, there must be a model that has already been calibrated using PEST with SVD-Assist. Selecting this option will cause an **Options** button to appear. This button will open the [Monte Carlo Options](#) dialog.

Only Save Solutions

With this option selected, during each stochastic iteration, changes are made to MODFLOW simulation and only a few files are saved. If this option is not selected, each stochastic iteration results in a new entire set of MODFLOW files being saved.

Using this option requires less disk space, but doesn't allow loading and rerunning individual stochastic iteration simulations.

Reading Stochastic Solutions

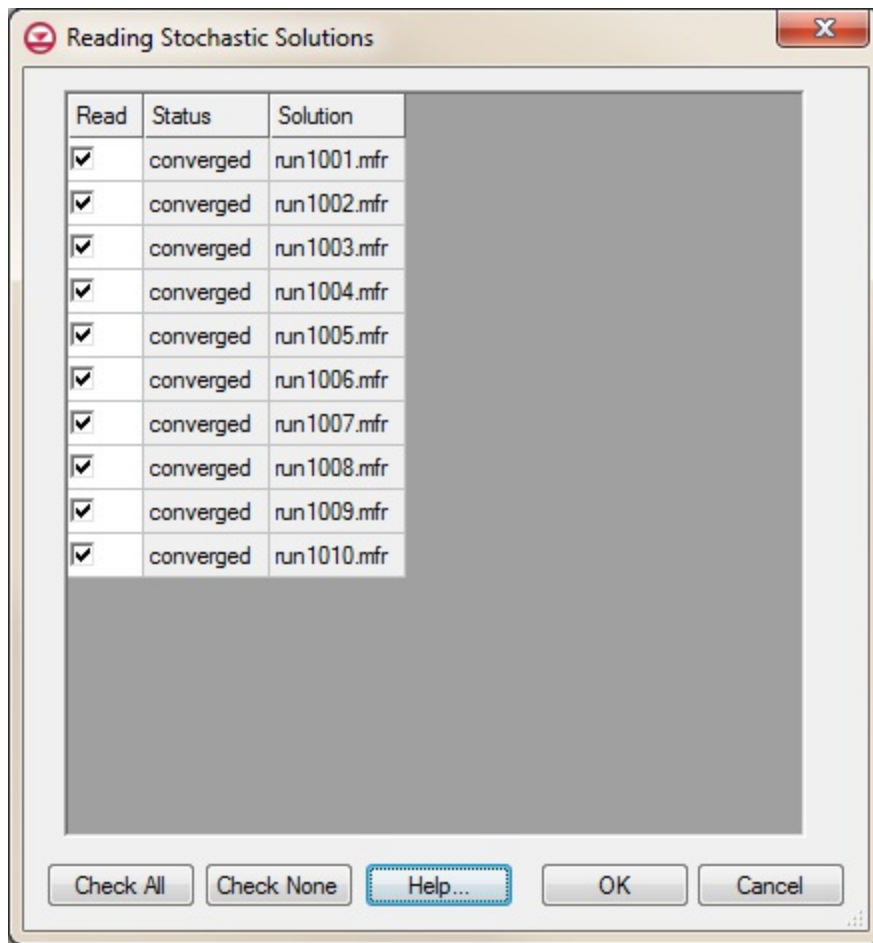

The Reading Stochastic Solutions dialog

At the completion of the model run, if the *Load Solution* option is checked, the *Reading Stochastic Solutions* dialog will appear when exiting the model wrapper. This dialog gives the option to select which stochastic solutions to load into GMS. Solution not read in at this time can be opened at a later time.

Stochastic Inverse Modeling

Stochastic inverse modeling is a [MODFLOW run option](#) that takes each run in a stochastic simulation and performs [parameter estimation](#) on the run to find the optimal values based on observation data. This option is very time consuming compared with a regular stochastic simulation and a parameter estimation run because GMS is doing parameter estimation for each stochastic run times.

Stochastic inverse modeling can be performed only when using [material sets](#) or [HUF arrays](#)

as chosen in the *Stochastic Options* dialog. [PEST](#) is the parameter estimation code supported by GMS.

The following occurs during the stochastic inverse process:

1. Run MODFLOW for the stochastic simulation iteration.
2. Set the starting head equal to the resulting heads from the MODFLOW run.
3. Run parameter estimation.
4. Run final MODFLOW (if needed for PEST).
5. Move to next stochastic simulation iteration.

The starting heads are interpolated to decrease the run times during the inverse portion.

Using Parameter Zonation With Stochastic Modeling

To create a stochastic MODFLOW simulation using parameter zonation, follow these steps:

- First define the zones using key values.
- [Define parameters](#) that link with the zones.
- Select the *Stochastic Simulation* option from the [Global Options](#) dialog.
- Select the *Parameter Randomization* option from the *Stochastic Options* dialog.
- Choose whether to use the *Random Sampling* or *Latin Hypercube* randomization approaches in the *Parameters* dialog.
- Save and run the model.
- View the different model results using the [Project Explorer](#).
- Further analyze the results using the [Risk Analysis Wizard](#).

Random Sampling

Random sampling is the most widely used approach for generating multiple random model

simulations. GMS supports both normal and uniform distributions.

A normal distribution can be defined as:

$$f(x) = \frac{1}{\sqrt{2\pi}\sigma} \exp\left(-\frac{(x - \mu)^2}{2\sigma^2}\right)$$

where σ is the standard deviation, μ is the mean, and x is the value being sampled. A uniform distribution can be defined as:

$$f(x) = \frac{1}{\beta - \alpha}$$

where α and β are the bounds of the parameter value x .

To set up the random sampling, specify the mean, standard deviation, and upper and lower bounds for each parameter. Finally, choose how many realizations to generate.

Latin Hypercube

The Latin hypercube randomization approach is a method that tries to efficiently probe the probability space for each parameter in a simulation in such a way that there is at least one simulation that represents every probability area for each parameter.

First, specify the number of segments for each parameter. The total probability, defined by a distribution, mean, standard deviation, and upper and lower bounds, is divided up into parts with equal probability (area). GMS then generates a random parameter value so that there is one value that lies within each probability segment.

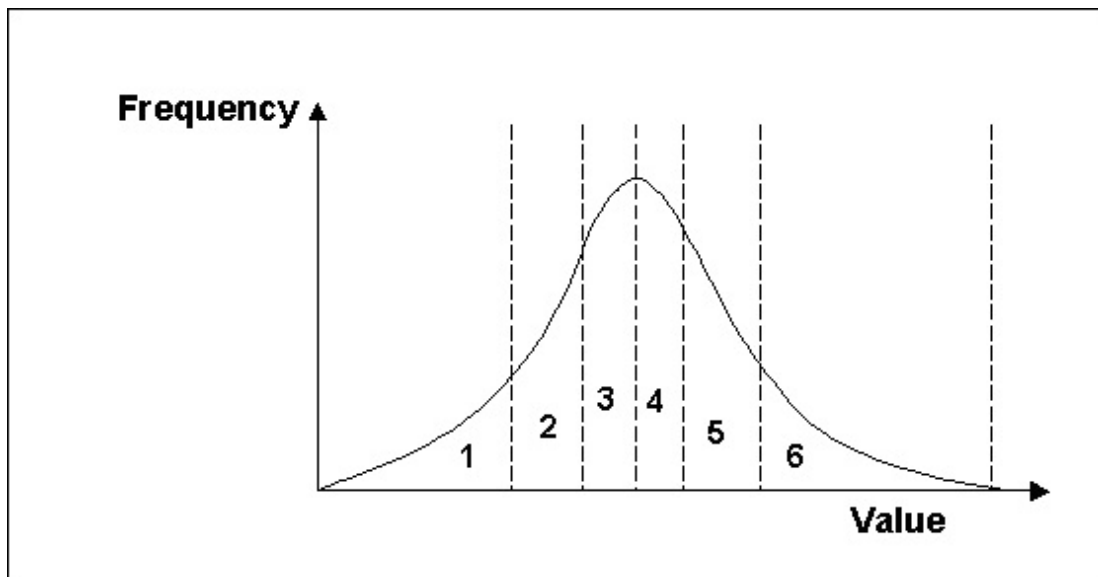

This is repeated in a combinatorial fashion for each parameter so that there are

$$\prod_{i=1}^n P_i$$

number of simulations, where n is the number of parameters and P is the number of segments for the i th parameter. For example, if there were three parameters with four, four, and five segments, the number of model runs would be as follows:

$$4 * 4 * 5 = 80$$

Using the Latin hypercube method has the benefit of needing a fewer number of runs to achieve the same level of confidence than the number required for the Monte Carlo approach because we have guaranteed that the entire probability range will be explored.

Using Indicator Simulations With Stochastic Modeling

GMS allows creating a stochastic simulation using output from T-PROGS. This can be in the form of either material sets or HUF data. Use the following steps:

- Generate Material Sets or HUF data using [T-PROGS](#).
- Select the *Stochastic Simulation* from the [Global Options dialog](#).

- Enter the *Stochastic...* dialog from the *MODFLOW* menu.
- Select the *Material Sets* option and choose the appropriate material set or HUF data simulation.
- Save and run MODFLOW.
- View the different model results using the [Project Explorer](#).
- Further analyze the results using the [Risk Analysis Wizard](#).
- GMS will generate as many MODFLOW runs as there are material sets.

Statistical Analysis of Stochastic MODFLOW/MT3DMS solutions

A statistical analysis can be computed on a Stochastic MODFLOW or MT3DMS solution by right-clicking on a stochastic folder in the [Project Explorer](#) and selecting the **Statistical Analysis** command. This command creates four datasets for the mean, min, max, and standard deviation. The 3D grid display options can then be used to visualize these datasets.

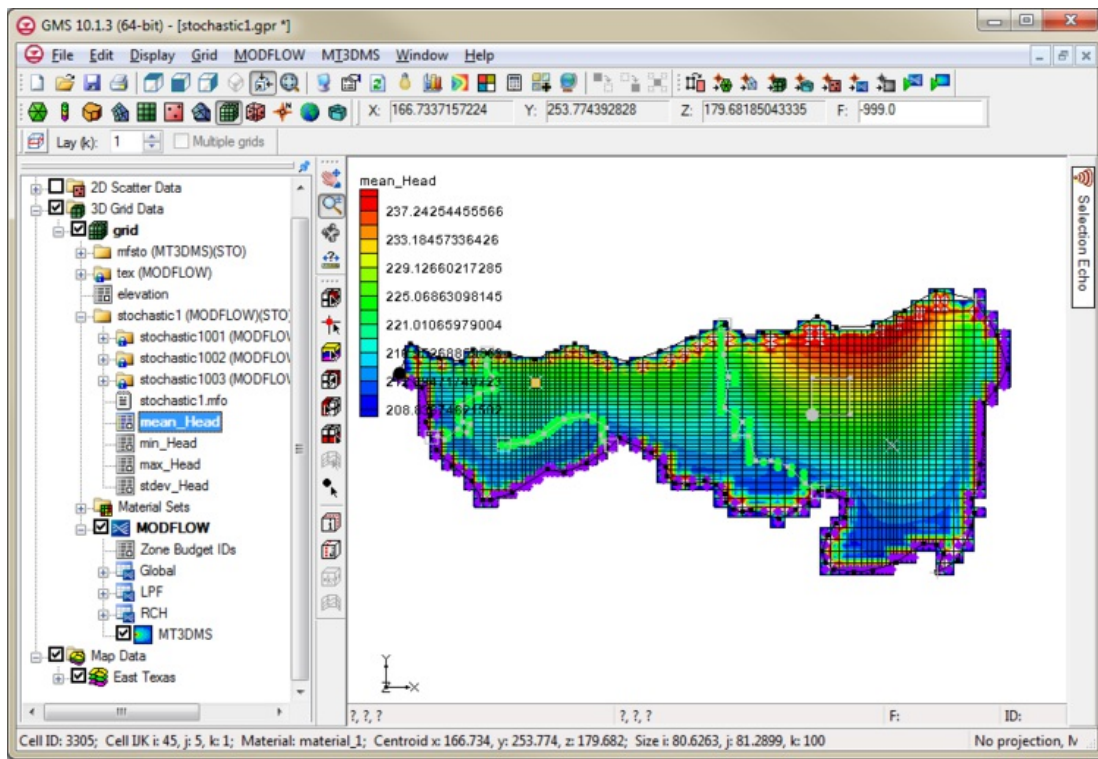

Stochastic statistical analysis example

Risk Analysis Wizard

The *Risk Analysis Wizard* is a tool for refining stochastic modeling results. The *Risk Analysis Wizard* has two options. The user can either perform a *Capture Zone Analysis* or a *Threshold Analysis*. *Capture zone analysis* requires a MODFLOW solution set, but threshold analysis can be performed on any solution set type.

Capture Zone Analysis

Capture zone analysis includes running [MODPATH](#) for each of the [MODFLOW](#) solutions to generate a capture zone for each well or zone code group in the MODFLOW model. These capture zones are combined into one probabilistic capture zone

Threshold Analysis

Threshold analysis is similar to *capture zone analysis*, but *threshold analysis* can be performed using any type of 3D dataset that has been read into the [Project Explorer](#).

1. First select a simulation set from the [Project Explorer](#).
2. Next, set up rules for generating a probabilistic threshold dataset. For example, the user might be looking at a specific contaminant and want to know what the probability is that the concentration of this contaminant will be above the EPA level for drinking water. The user would generate a rule reflecting this limit. After processing all rules for each simulation, GMS creates a probabilistic threshold dataset.

Risk Analysis Wizard Dialogs

The *Risk Analysis Wizard* is entered through the right-click menu for a folder in the [Project Explorer](#) and choose **Risk Analysis...** .

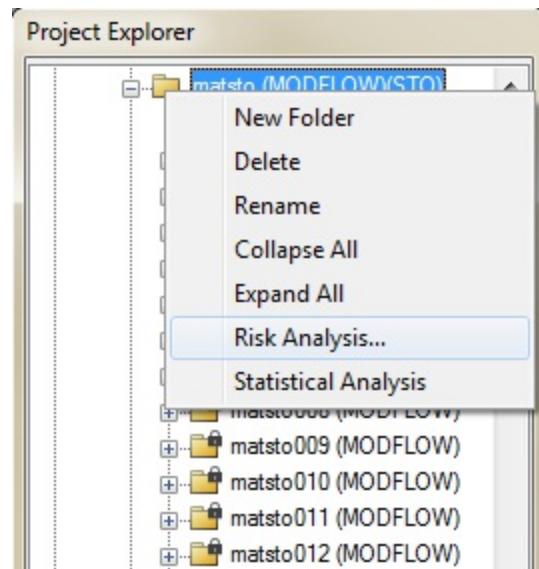

Choosing Between Capture Zone and Threshold Analysis

The first step in the *Risk Analysis Wizard* is to choose what type of simulations to process.

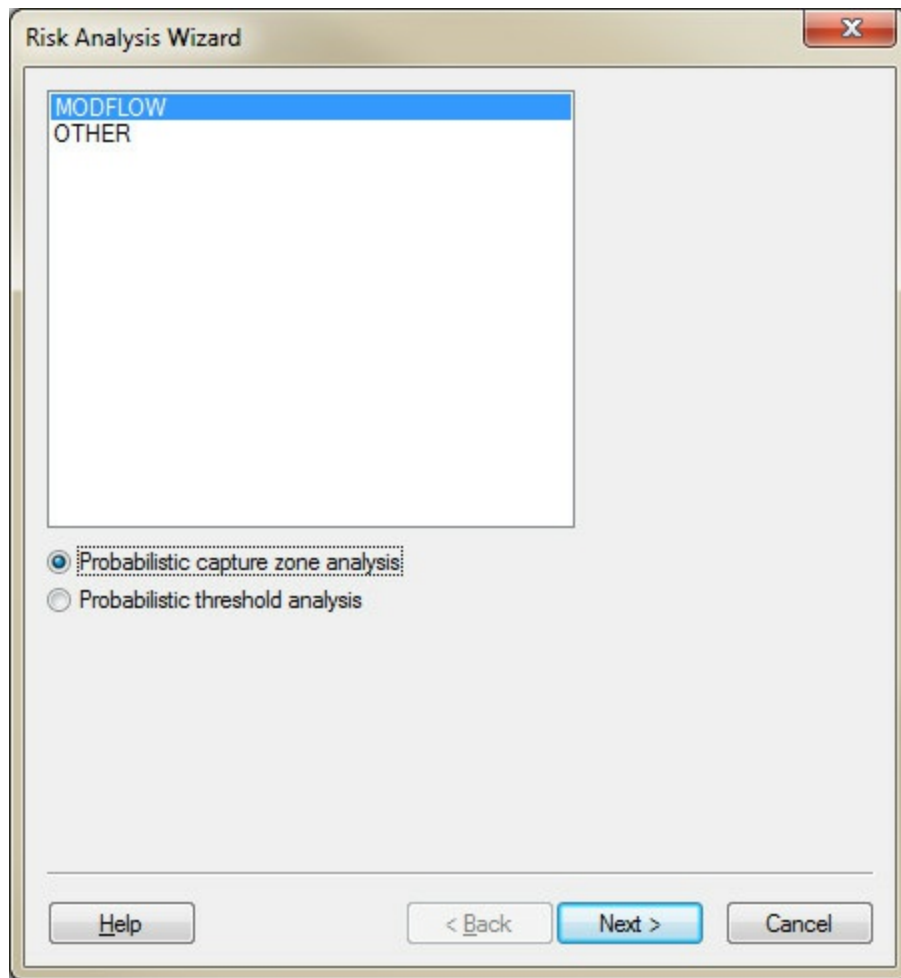

Risk Analysis Wizard dialog

The window will list all the solution types as the analysis wizard will only process solutions of the same type. Probabilistic capture zone analysis can only be performed on MODFLOW solutions. Probabilistic threshold analysis can be performed on any solution type.

Capture Zone Analysis Dialog

Capture Zone Analysis can only be performed on MODFLOW solutions

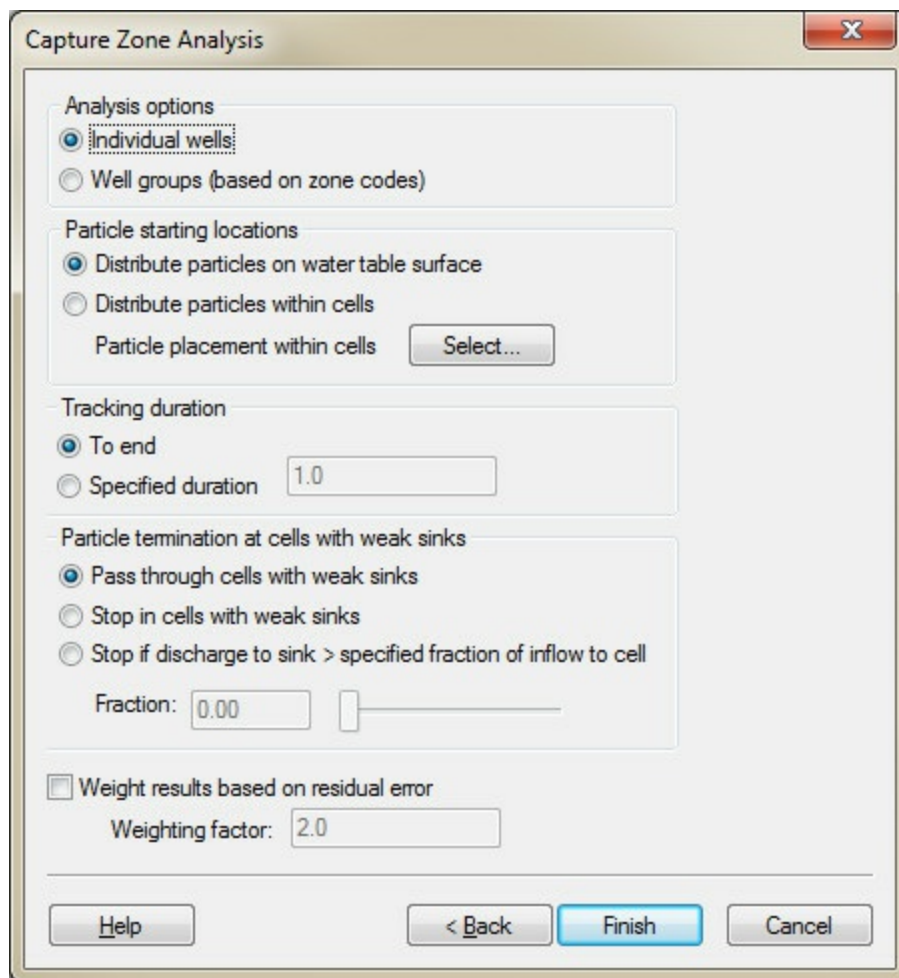

Capture Zone Analysis dialog

Analysis Options – Individual wells

Choose this option to create a probabilistic capture zone for each uniquely named well in the MODFLOW model.

Analysis Options – Well groups

Choose this option to create a probabilistic capture zone for each different zone code number.

Particle Starting Locations – Distribute particles on water table surface

Choose this option to distribute particles only on the water table surface. By default, one particle is placed at the *xy* center of the cell at the water table, but the user can use the *Particle placement within cells* option to change the number of particles placed on the water table in each cell. This option will create a 2D probabilistic capture zone

representing the intersection of the entire 3D probabilistic capture zone with the water table.

Particle Starting Locations – Distribute particles within cells

Choose this option to distribute particles within each cell. By default, one particle is placed at the center of each cell, but the user can use the *Particle placement within cells* option to change the number of particles placed on within each cell. This option creates three different probabilistic capture zones. The first represents the 3D capture zone, the other two represent different 2D projections of the 3D capture zone.

Tracking Duration – To end

This option sets MODPATH to move particles through the flow field until they exit the model.

Tracking Duration – Specified duration

This option sets MODPATH to move particles through the flow field until they either exit the model or the time reaches the duration set, which ever comes first.

Particle Placement Within Cells

This option allows the user to change the number of particles per cell from the default of one. Increase the number of particles leads to a smoother capture zone, but drastically increases the computation time.

Weight Results Based On Residual Error

In all of the capture zone methods, the algorithms used to synthesize the probability data set can be weighted using observation data. This makes it possible to give more weight to model instances with smaller calibration error when calculating the capture zone probabilities. The weighted head and flow observations can be compared to the computed values to come up with a global error norm, E , for each model run. This error norm can be based on the root mean squared (RMS) error, the sum of the squared weighted residuals, or any other measure selected by the modeler. For capture zone analysis, GMS uses the sum of squared weighted residuals (SSWR) for the error norm. The error norm from each MODFLOW run is used to compute a weight for the given solution using the following equation:

$$w_i = \alpha \left[\frac{ME - E_i}{SD} \right] \dots\dots\dots(1)$$

Where W_i is the weight applied to solution i , α is a user-defined factor, ME is the mean of the error values from all solutions, E_{jk} is the error for solution i , and SD is the standard deviation of error values from all solutions. The weights are also normalized as follows

$$w_{final} = \frac{w_i}{\sum w_i} \dots\dots\dots(2)$$

so that the weights sum to unity. Equation 1 was developed to give the greater emphasis to the lower error values and to allow controlling the relative emphasis given to low vs. high values simply by adjusting the α value. The equation also avoids problems when one of the error values is zero, since a zero error value does not result in an infinite weight. The equation is also designed to allow scaling the weights according to the data being examined. This is done by subtracting the individual SSWR from the mean error and dividing by the standard deviation.

Equation 1 centers the weights on the mean error. The relative weight given to values differing from the mean is biased by the factor. This makes it possible to bias the resulting weight using knowledge of the site and the quality of the observation data.

The figure below shows how the α factor in Equation 1 affects the weight applied to a given error. An α factor of 1.2 makes the contribution of each SSWR almost linear, whereas an α factor of ten gives most of the weight to the lowest 5–10 percent while discounting the other error values. Typically use an α value of 2.0.

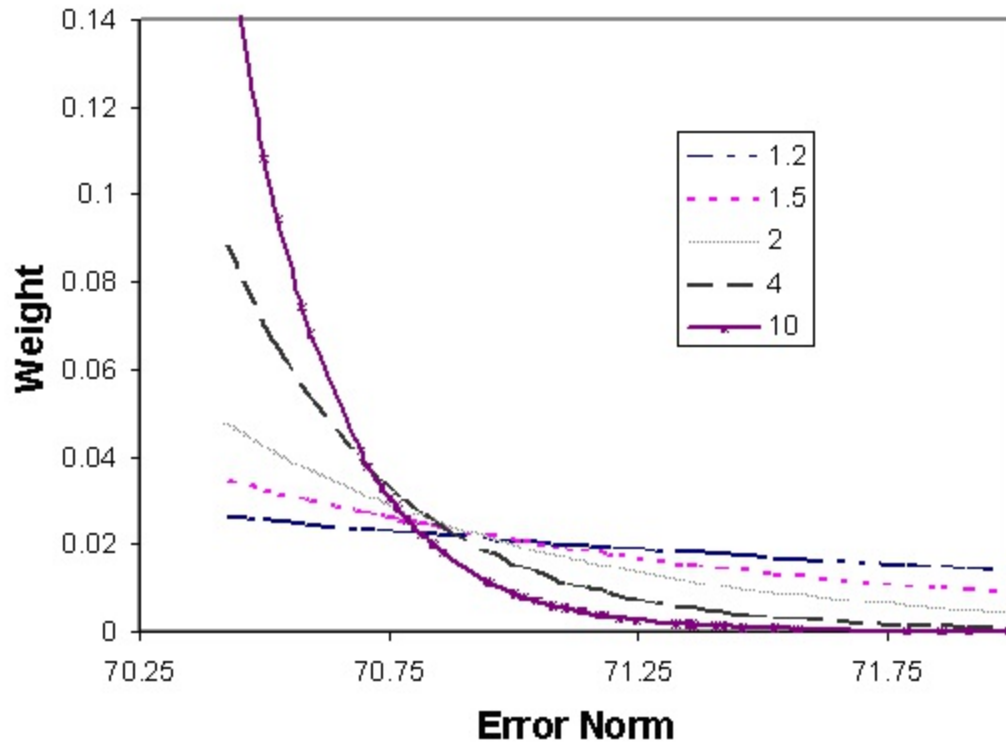

Weight versus Error Norm Plot

Threshold Analysis Dialog

Threshold analysis can be performed on any collection of 3D datasets. The threshold analysis dataset is created by using rules. For each rule, select a dataset (only applies to solutions with multiple data sets.), the greater or less than sign and a value. There is no limit to the number of rules that can be created. The AND and OR logic options allow the user to use: 1st rule AND 2nd rule AND 3rd rule; or 1st rule OR 2nd rule OR 3rd rule. Threshold analysis creates one 3D dataset.

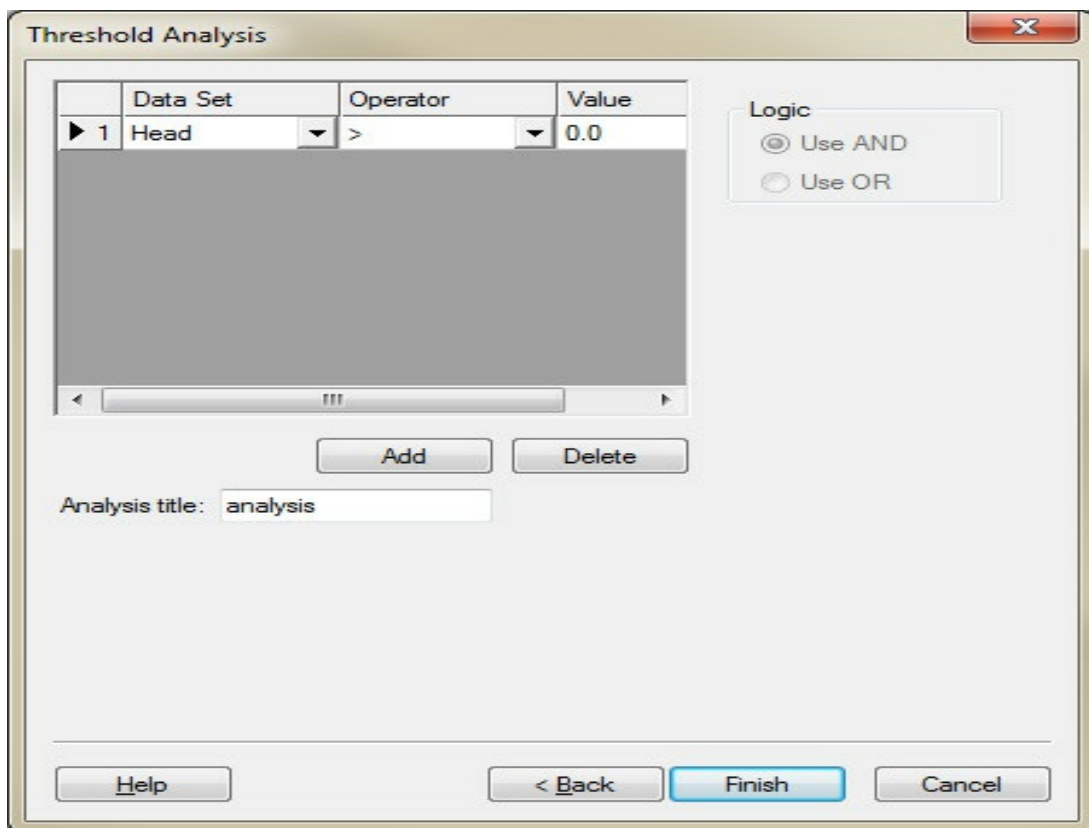

Threshold Analysis dialog

8. Importing/Exporting Data

Importing Non-native GMS Files

GMS can import many files generated by other software in their native format. The files that can be imported to GMS are shown in the tables below. Each file type is identified by the file extension. The file filter corresponding to the desired extension should be selected in the *Open File* dialog.

File Import Wizard

In addition to the file types listed below, several other types of data can be imported via the *File Import Wizard*. Refer to the section on the [File Import Wizard](#) for more information.

File Type	File Ext	Description
Model Super Files	*.mfs, *.rsp, *.mts, *.rts, *.sms, *.uts, *.fws, *.ats, *.sps	GMS uses super files to help organize model files, which can be numerous. Opening the super file will import the entire model and all associated model files. This will NOT open any GMS specific data, such as Map data or TIN data etc. The file models associated with each super file extension are as follows: *.mfs = MODFLOW, *.rsp = MODPATH, *.mts = MT3DMS, *.rts = RT3D, *.sms = SEAM3D, *.uts = UTCHEM, *.fws = FEMWATER, *.ats = ART3D, *.sps = SEEP2D
Text files	*.txt	Text files where the data is in columns, as might be exported from a spreadsheet. This brings up the GMS File Import Wizard . Many different types of data can be brought in to GMS by using the File Import Wizard.
DXF/DWG	*.dxf, *.dwg	Vector drawing data used for background display or for conversion to feature objects.
JPEG - TIFF	*.jpg, *.tif	Raster image files used for background display or for texture mapping to a surface.
Shapefiles	*.shp	ArcView shapefiles.
DEM / Grid	*.asc, *.ddf, *.ggd, *.dem	ASCII 2D grid exported from Arc/Info or ArcView, ASCII 2D grid exported from GRASS
Surfer Grid	*.grd	ASCII 2D grid exported from Surfer.

See also

- [File Import Wizard](#)

File Import Wizard

GMS can import many files generated by other software in their native format. Refer to [Importing Non-native GMS Files](#) for a list. For files that are not included in the list, GMS provides the *File Import Wizard*.

The *File Import Wizard* enables importing many different types of data into GMS. The *File Import Wizard* is initialized by selecting a *.txt file in the **Open** command from the *File* menu. The wizard has two steps.

Step 1 – Delimiting Columns

The first step in the wizard allows delimiting the data into columns. Two options exist to delimit the data: *Delimited*, *Fixed Width*.

For the *Delimited* option, typical delimiters are included as well as an option to specify a delimiter. Columns can also be specified with a fixed width by clicking on the ruler bar or the window with the data. Breaklines can be dragged, and they can be deleted by double-clicking on the break line or dragging them off the screen. Specify the starting row the data will be imported at. If the data has a row of headings, indicate such and GMS will use the headings in the next step to determine what kind of data each column represents.

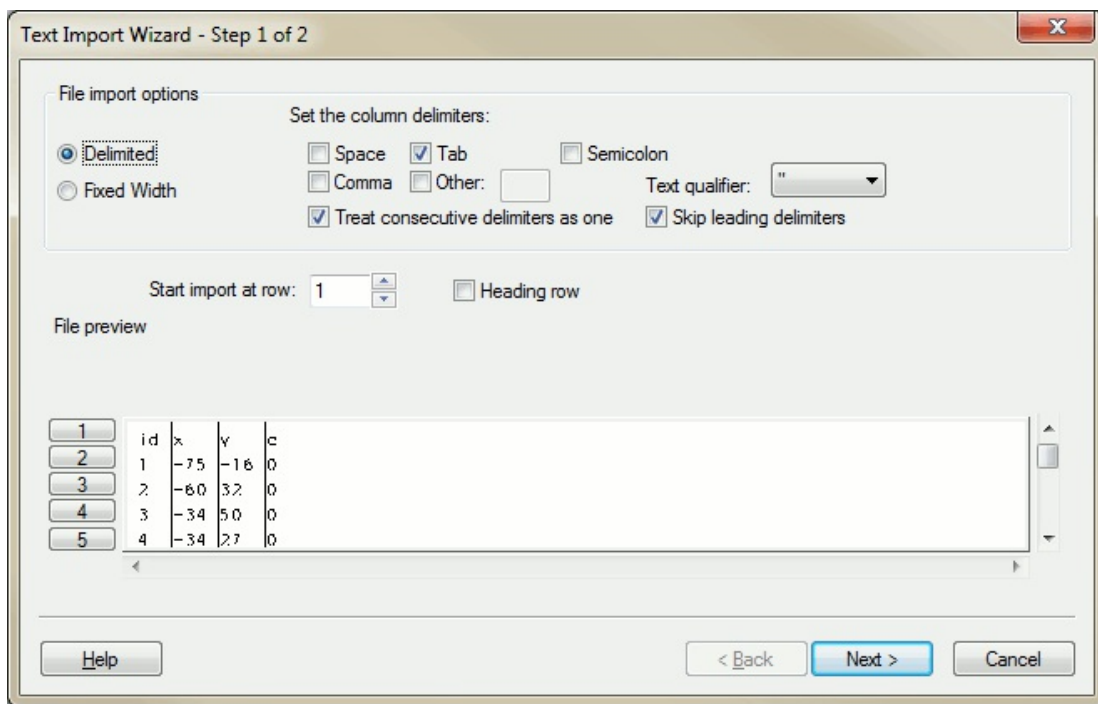

Step 1 File import options of the File Import Wizard.

Step 2 – Assigning Column Types

The first 20 lines of the file are displayed in a spreadsheet according to the file outline specified in step 1. This step selects what kind of data to import (see [Supported File Formats](#)). A *No data flag* can be specified for the file. This is a number that, when encountered in the file, tells GMS to mark the value as "NULL" or "no data".

The data in the columns are identified by selecting the type in the combo box at the top of each column in the spreadsheet. If a row of headings exists, GMS will automatically select the proper type if it recognizes the heading. Otherwise they are *Not Mapped* by default. The available column types changes depending on the GMS data type selected. Certain column types must be mapped for each file format before progressing to the next step in the wizard. The name of each column is changed by editing the *Header* cell.

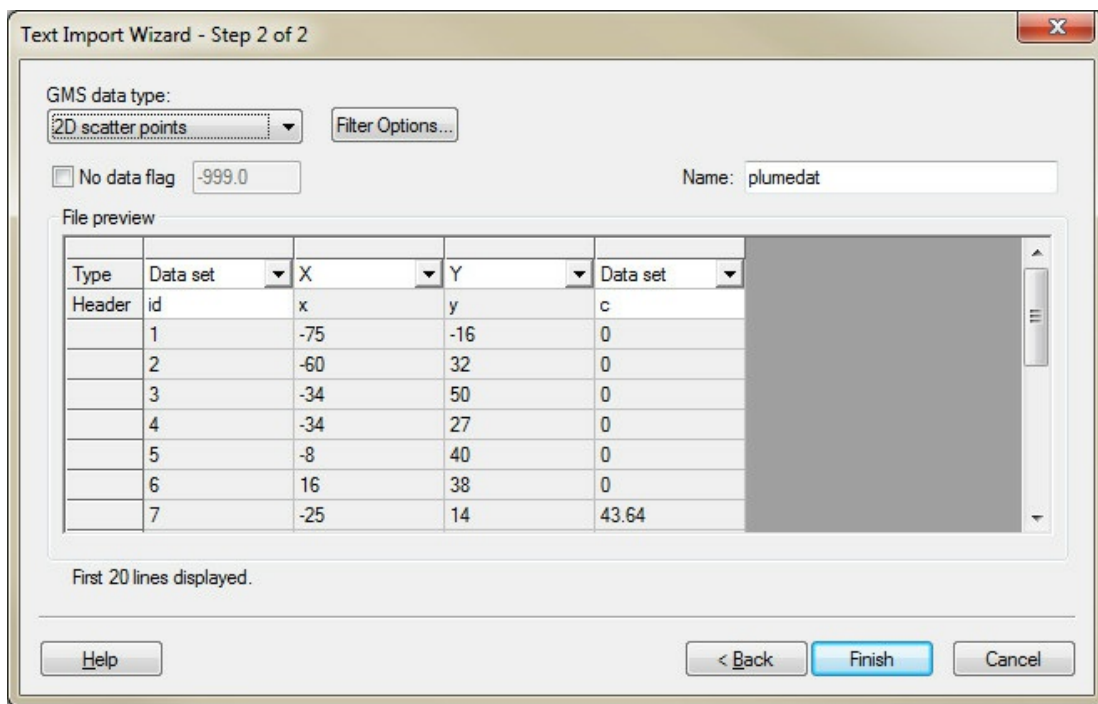

Step 2 (File Format) of the File Import Wizard.

After the data have been imported, the [coordinate transformation](#) tools can be used to transform and translate the data.

File Import Wizard Supported File Formats

The *File Import Wizard* can import various types of data as described in the tables below.

2D UGrid points

This will create new points in a new **UGrid**. Optionally the imported points can be filtered using the filter options available by selecting the **Filter Options** button.

Field	Type	Required	Comments
X	Number	yes	
Y	Number	yes	
Z	Number	no	Point Zs are set to 0.0 if omitted
Dataset	Number	no	Any number of steady-state or transient datasets can be imported. When importing transient datasets, a dataset name and a time step must be specified for each transient column. Names and time steps are entered into the header row, separated by a vertical slash using the following format: "Name Timestep". For example, "Dataset1 January 1, 1900". All time steps of a transient dataset should be given the same name.

Examples

These examples can be copied and pasted into GMS.

Steady state

"x"	"y"	"xylene"	"toluene1"	"toluene2"
32.4	74.3	300	999	999
93.4	32.3	84	398	401
83.3	48.2	89	47	52
46.8	29.1	207	147	134

Transient

"x"	"y"	"xylene 01/01/2000 00:00"	"xylene 01/01/2000 12:00"	"xylene 01/02/2000 00:00"
32.4	74.3	300	87	276
93.4	32.3	84	310	187
83.3	48.2	89	148	198
46.8	29.1	207	147	134
40.3	50.1	158	213	32
60.7	52.0	27	41	300
78.7	72.9	264	275	206

3D UGrid points

This will create new points in a new [UGrid](#).

Field	Type	Required	Comments
X	Number	yes	
Y	Number	yes	
Z	Number	yes	
Dataset	Number	no	Any number of steady-state or transient datasets can be imported. When importing transient datasets, a dataset name and a time step must be specified for each transient column. Names and time steps are entered into the header row, separated by a vertical slash using the following format: "Name Timestep". For example, "Dataset1 January 1, 1900". All time steps of a transient dataset should be given the same name.

Examples

These examples can be copied and pasted into GMS.

Steady state

"x"	"y"	"z"	"xylene"	"toluene 0.0"	"toluene 2.0"
32.4	74.3	10.1	300	87	999
93.4	32.3	25.7	84	310	187
83.3	48.2	5.3	89	148	198
46.8	29.1	-42.2	207	147	134

Transient

"x"	"y"	"z"	"xylene 01/01/2000 00:00"	"xylene 01/01/2000 12:00"	"xylene 01/02/2000 00:00"
32.4	74.3	10.1	300	387	276
93.4	32.3	25.7	84	310	187
83.3	48.2	5.3	89	148	198
46.8	29.1	-42.2	207	147	134

2D scatter points

This will create new scatter points in a new [2D scatter set](#). Optionally the imported points can be filtered using the filter options available by selecting the **Filter Options** button.

Field	Type	Required	Comments
X	Number	yes	
Y	Number	yes	
Label	Text	no	
Dataset	Number	no	Any number of steady-state or transient datasets can be imported. When importing transient datasets, a dataset name and a time step must be specified for each transient column. Names and time steps are entered into the header row, separated by a vertical slash using the following format: "Name Timestep". For example, "Dataset1 January 1, 1900". All time steps of a transient dataset should be given the same name.

Examples

These examples can be copied and pasted into GMS.

Steady state

"id"	"x"	"y"	"xylene"	"toluene 0.0"	"toluene 2.0"
"OW-21"	32.4	74.3	300	999	999
"OW-22"	93.4	32.3	84	398	401
"OW-23"	83.3	48.2	89	47	52
"OW-24"	46.8	29.1	207	147	134

Transient

"id"	"x"	"y"	"xylene 01/01/2000 00:00"	"xylene 01/01/2000 12:00"	"xylene 01/02/2000 00:00"
"OW-21"	32.4	74.3	300	87	276
"OW-22"	93.4	32.3	84	310	187
"OW-23"	83.3	48.2	89	148	198
"OW-24"	46.8	29.1	207	147	134
"OW-25"	40.3	50.1	158	213	32
"OW-26"	60.7	52.0	27	41	300
"OW-27"	78.7	72.9	264	275	206

3D scatter points

This will create new scatter points in a new [3D scatter set](#).

Field	Type	Required	Comments
X	Number	yes	
Y	Number	yes	
Z	Number	yes	
Label	Text	no	
Material ID	Number	no	
Dataset	Number	no	Any number of steady-state or transient datasets can be imported. When importing transient datasets, a dataset name and a time step must be specified for each transient column. Names and time steps are entered into the header row, separated by a vertical slash using the following format: "Name Timestep". For example, "Dataset1 January 1, 1900". All time steps of a transient dataset should be given the same name.

Examples

These examples can be copied and pasted into GMS.

Steady state

"id"	"x"	"y"	"z"	"xylene"	"toluene 0.0"	"toluene 2.0"
"OW-21"	32.4	74.3	10.1	300	87	999
"OW-22"	93.4	32.3	25.7	84	310	187
"OW-23"	83.3	48.2	5.3	89	148	198
"OW-24"	46.8	29.1	-42.2	207	147	134

Transient

"id"	"x"	"y"	"z"	"xylene 01/01/2000 00:00"	"xylene 01/01/2000 12:00"	"xylene 01/02/2000 00:00"
"OW-21"	32.4	74.3	10.1	300	387	276
"OW-22"	93.4	32.3	25.7	84	310	187
"OW-23"	83.3	48.2	5.3	89	148	198
"OW-24"	46.8	29.1	-42.2	207	147	134

Observation data

This creates new [feature points](#) in the existing, active [coverage](#). The active coverage must exist and have a steady state [observation](#) attribute (such as "Head") defined.

Field	Type	Required	Comments
Point Name	Text	no	
X	Number	yes	
Y	Number	yes	
Z	Number	no	
Layer	Number	no	The 3D grid layer the point is associated with.
Measurement	Text	no	Measurement name. Multiple measurements allowed.
Interval	Number	no	Use Interval and Confidence, or Std. Dev. but not both.
Confidence	Number	no	Use Interval and Confidence, or Std. Dev. but not both.
Standard Deviation	Number	no	Use Interval and Confidence, or Std. Dev. but not both.

Example

"id"	"x"	"y"	"z"	"lay"	"hd"	"int"	"conf"
"OBS_Q5"	23.3	44.2	32.2	1	567.5	1.2	95
"OBS_Q6"	83.3	84.3	32.2	1	555.3	1.4	90
"OBS_Q7"	85.3	39.3	33.2	1	999	0	0

Transient observation data

This adds time series [curves](#) to existing [points](#) in an existing [observation coverage](#). The targeted coverage must be the active coverage.

The existing points and the data being imported are matched by *Name* or *ID*. If both *Name* and *ID* are specified then *ID* will take precedence.

Both *Date* and *Time* can be specified although data can be imported with only *Date* or only *Time* specified (at least one of these fields must be specified). If only the *Date* is specified then the time is set to 12:00:00 AM. If only *Time* is specified then it is assumed that date/time format is not being used and the time is treated as a relative time.

Field	Type	Required	Comments
Name	Text	no	Either Name or ID must be specified
ID	Text	no	Either Name or ID must be specified
Date	Date	no	Either Date or Time or both must be specified
Time	Time	no	Either Date or Time or both must be specified

Example

"id"	"date"	"time"	"head"
"OBS_Q5"	12/3/1999	18:00:00	238.5
"OBS_Q5"	1/30/2000	07:38:25	834.7
"OBS_Q6"	3/27/2000	18:00:00	878.3
"OBS_Q6"	12/3/1999	18:00:00	733.2

Well data

This creates new **feature points** in an existing **coverage**. The point types are set to "well" and the flow rate and other data are assigned to the points. A coverage with the *Wells* attribute must already exist and be the active coverage.

Field	Type	Required	Comments
Name	Text	no	
X	Number	yes	
Y	Number	yes	
Z	Number	no	Elevation of top of well.
Depth	Number	no	Depth to top of screen.
Screen Length	Number	no	
Flow Rate	Number	no	Positive for injection, negative for extraction.

Example

"id"	"x"	"y"	"z"	"depth"	"len"	"Q"
"well_1"	123.5	843.2	62.0	51.4	6.0	120.5
"well_2"	134.2	789.4	62.8	60.7	5.4	100.3
"well_3"	147.2	678.1	61.4	110	10.0	300.5

MODFLOW Well Package data

This creates new well boundary conditions in an existing MODFLOW simulation. Both steady state (one flow rate per well) or transient data (multiple flow rates at different times per well) can be imported. With transient data, multiple rows are used to list flow rates at different times (or date/times) and the *Well Name* field is used to associate the flow rates with the correct well. The times for changes in flow rate do not need to match the model stress period times. Flow rate curves are treated as stair step data and the rate for each stress period is found by temporal (time) interpolation. A prompt will ask if wanting to use the average flow rate for each stress period, or use the flow rate at the beginning of each stress period.

Field	Type	Required	Comments
Layer	Number	yes	
Row	Number	yes	
Column	Number	yes	
Well Name	Text	yes	Any text used as the well identifier.
Flow Rate	Number	no	Positive for injection, negative for extraction.
Date	Date	no	If neither Date nor Time is specified, all stress periods will have the same Q.
Time	Time	no	Use this field for relative times (starting from 0.0), or if specifying an actual time of day (5:00) to go with the Date field. If neither Date nor Time is specified, all stress periods will have the same Q.

Example

"Layer"	"Row"	"Column"	"Rate"	"Well Name"	"Date"	"Time"
1	2	2	-502	City Well #1	Jan 1, 1940	5:00
1	2	2	-431	City Well #1	July 1, 1940	5:00
1	4	4	0	W5088341	July 1, 1940	5:00
1	4	4	-1000	W5088341	July 1, 1941	6:00

Pumping data

This adds time series [curves](#) to existing [points](#) in an existing [coverage](#) containing wells. The targeted coverage must be the active coverage. The existing points and the data being imported are matched by name.

Field	Type	Required	Comments
Well Name	Text	yes	Must match an existing well, or else data is ignored.
Date	Date	No	Either Date or Time or both must be specified.
Time	Time	No	Either Date or Time or both must be specified.
Flow Rate	Number	yes	Positive for injection, negative for extraction.
Depth	Number	no	Depth to top of screen.
Screen Length	Number	no	

Example

"id"	"date"	"time"	"Q"
"well_1"	12/3/1999	18:00:00	625.0
"well_1"	1/30/2000	07:38:25	0
"well_2"	12/3/1999	18:00:00	0
"well_2"	3/3/2000	14:48:32	100.0

Borehole data

This creates new [boreholes](#). Optionally, a borehole folder name can be specified to organize the imported boreholes.

Field	Type	Required	Comments
Borehole Name	Text	yes	
X	Number	yes	X location of the contact.
Y	Number	yes	Y location of the contact.
Z	Number	yes	Z location of the contact.
HGU ID	Number	yes	HGU Material below the contact
Material ID	Number	no	Material below the contact.
Horizon ID	Number	no	
Description	Text	no	Description of the material (usually from drilling report).

"id"	"x"	"y"	"z"	"material"	"horizon"
"borehole_1"	0.0	0.0	0.0	3	1
"borehole_1"	0.0	0.0	10.0	1	2
"borehole_1"	0.0	0.0	15.0	6	4
"borehole_2"	5.0	0.0	1.0	2	3
"borehole_2"	5.0	0.0	6.0	2	4

Borehole sample data

This creates new [sample data](#) on existing [boreholes](#), or new sample data on new boreholes if no boreholes with matching names exist. All existing sample data is replaced with that being imported.

Field	Type	Required	Comments
Name	Text	yes	New Borehole Name
X	Number	yes	X location of the borehole.
Y	Number	yes	Y location of the borehole.
Z	Number	yes	Z location of the borehole, in descending order, top to bottom.
Dataset	Number	yes	

"id"	"x"	"y"	"z"	"data"
"borehole_1"	0.0	0.0	20.0	495
"borehole_1"	0.0	0.0	15.0	484
"borehole_1"	0.0	0.0	10.0	454
"borehole_2"	5.0	0.0	6.0	259
"borehole_2"	5.0	0.0	1.0	248

Transient point data

This creates new time series [curve](#) data on existing [feature points](#) similar to the ["Pumping data"](#) option above. This option is more generic than the ["Pumping data"](#) option, however, because it will work with feature points of any type and any attribute (that can be transient) of that feature point.

The existing points and the data being imported are matched by *Name* or *ID* or *X* and *Y*.

The order of precedence for these fields is *ID*, *Name*, then *X* and *Y*. Beginning with *GMS* version 10.1, if multiple multiple points in the coverage have the same name and the imported data are matched by *Name* then a new time series will be created for all of the points with that name.

Both *Date* and *Time* can be specified although data can be imported with only *Date* or only *Time* specified (at least one of these fields must be specified). If only the *Date* is specified then the time is set to 12:00:00 AM. If only *Time* is specified then it is assumed that date/time format is not being used and the time is treated as a relative time.

Data for more than one attribute can be imported at the same time. The attributes of the active coverage are listed as available fields that can be mapped.

Field	Type	Required	Comments
Name	Text	No	Name or ID or X and Y must be specified.
ID	Number	No	Name or ID or X and Y must be specified.
Date	Date	No	Either Date or Time or both must be specified.
Time	Time	No	Either Date or Time or both must be specified.
X	Number	No	Name or ID or X and Y must be specified.
Y	Number	No	Name or ID or X and Y must be specified.
[Attribute1...]	Number	No	The value of the selected attribute at the given date/time.
[AttributeN]	Number	No	The value of the selected attribute at the given date/time.

"id"	"date"	"time"	"x"	"y"	"Flow rate"
"well_1"	12/3/1999	18:00:00	123.5	843.2	625
"well_1"	1/30/2000	07:38:25	123.5	843.2	0
"well_2"	3/27/2000	18:00:00	134.2	789.4	0
"well_2"	12/3/1999	18:00:00	134.2	789.4	100.0

Transient node data

Similar to [transient point data](#) but for *nodes*. Since nodes don't have names they must be matched by ID or XY location.

Field	Type	Required	Comments
ID	Number	No	Either ID or X and Y must be specified.
Date	Date	No	Either Date or Time or both must be specified.
Time	Time	No	Either Date or Time or both must be specified.
X	Number	No	Either ID or X and Y must be specified.
Y	Number	No	Either ID or X and Y must be specified.
[Attribute1...]	Number	No	The value of the selected attribute at the given date/time.
[AttributeN]	Number	No	The value of the selected attribute at the given date/time.

Transient arc data

Similar to [transient point data](#) but for [arcs](#). Since arcs don't have a single XY location they must be matched by ID or name.

Field	Type	Required	Comments
Name	Text	No	Either Name or ID must be specified.
ID	Number	No	Either Name or ID must be specified.
Date	Date	No	Either Date or Time or both must be specified.
Time	Time	No	Either Date or Time or both must be specified.
[Attribute1...]	Number	No	The value of the selected attribute at the given date/time.
[AttributeN]	Number	No	The value of the selected attribute at the given date/time.

Transient polygon data

Similar to [transient point data](#) but for [polygons](#). Since polygons don't have a single XY location they must be matched by ID or name.

Field	Type	Required	Comments
Name	Text	No	Name or ID must be specified.
ID	Number	No	Name or ID must be specified.
Date	Date	No	Either Date or Time or both must be specified.
Time	Time	No	Either Date or Time or both must be specified.
[Attribute1...]	Number	No	The value of the selected attribute at the given date/time.
[AttributeN]	Number	No	The value of the selected attribute at the given date/time.

Dataset

Datasets can be imported from columnar text files and added to geometric objects (TINs, UGrids etc.). However text files containing datasets are not imported via the *File | Open* command (or pasting into the GMS window), but via the *Import Dataset* command found in the right-click menu of objects in the Project Explorer (objects that can have datasets). The format is similar as that of 2D or 3D scatter points as described above, but with only the dataset columns. The number of dataset values in the file must match the number of locations (points or cells) on the geometric object.

Field	Type	Required	Comments
Dataset	Number	yes	Any number of steady-state or transient datasets can be imported. When importing transient datasets, a dataset name and a time step must be specified for each transient column. Names and time steps are entered into the header row, separated by a vertical slash using the following format: "Name Timestep". For example, "Dataset1 January 1, 1900". All time steps of a transient dataset should be given the same name.

Steady state example

"xylene"	"toluene 0.0"	"toluene 2.0"
300	999	999
84	398	401
89	47	52
207	147	134

Transient example

"xylene 01/01/2000 00:00"	"xylene 01/01/2000 12:00"	"xylene 01/02/2000 00:00"
300	87	276
84	310	187
89	148	198
207	147	134
158	213	32
27	41	300
264	275	206

Importing/Exporting CAD Data

Importing

GMS can import DWG or DXF files via the *File* | **Open** command. If there is already CAD data in memory, GMS will replace the existing data with the data being imported. Currently, GMS cannot merge the incoming data with the data in memory.

Exporting

GMS data can be exported to a DWG or DXF file that can then be read into a CAD software package. If there is CAD data in memory when a GMS project is saved, GMS creates a new DWG file from the CAD data. The file is put in the same folder with the other project files and named using the project prefix.

Any CAD data in memory can be exported by right-clicking the CAD folder  in the Project Explorer and selecting the **Export** command. The *DWG/DXF Filename* dialog will appear. Either the DWG or DXF file types can be selected when saving CAD data. GMS objects must first be converted to CAD data before CAD data can be exported. To convert GMS data to CAD data, use the **Convert To CAD** command in the *Display* Menu.

Starting at GMS 9.0, multiple CAD files can be included in the project at once. GMS does not write to these files when the GMS project is saved, it merely links to the CAD files.

CAD Properties

The *CAD Properties* dialog displays data about the CAD file such as: path on disk, extents in xy, and file version. The dialog is reached by right-clicking on the CAD data item in the Project Explorer and selecting the **Properties** command.

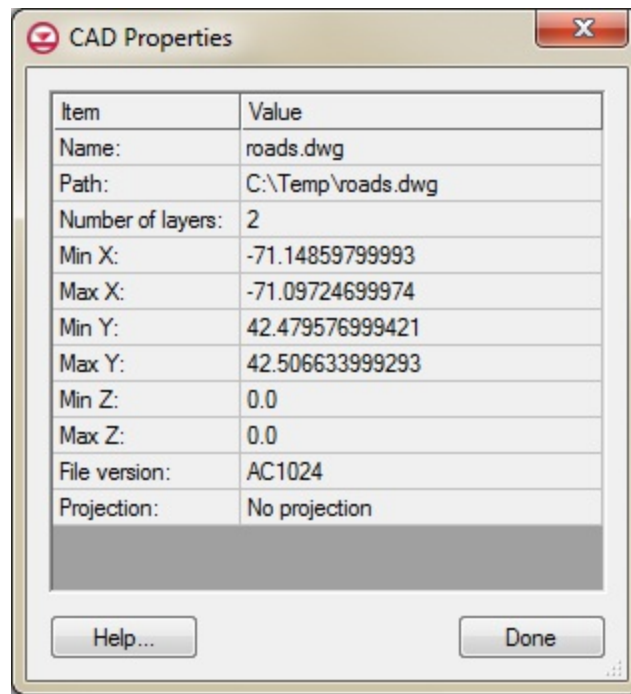

Example of the CAD Properties dialog

See also

- [CAD Menu](#)

Importing USGS DEMs

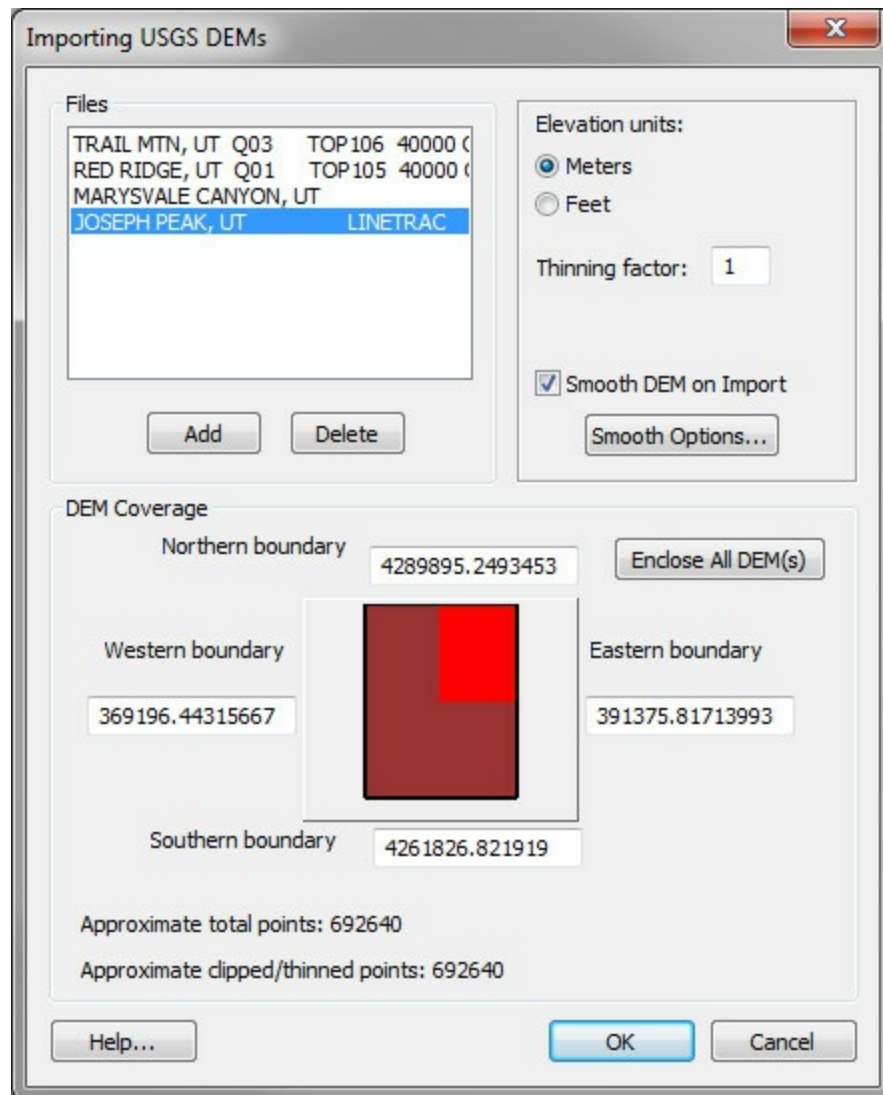

Import USGS DEMs dialog

The *Import USGS DEMs* dialog is used to examine the limits of DEM files as well as defining a clipping boundary to eliminate regions outside the area of interest prior to actually reading the elevations in. The **Add** button is used to add a new file to the list of files (it is now possible to select multiple DEM files at the same time rather than adding them one at a time, but they must all be of the same format) that will be read. The standard file opening dialog appears from which DEM files can be selected. Once the file(s) are added to the list a bounding rectangle is displayed in the small graphics window in the center of the dialog. As additional files are added the graphics region is updated with new rectangles in order to

provide an understanding of where DEMs are located in relation to one another.

A small black rectangle is displayed in the central graphics window. Only elevation points inside this rectangular region will be read in when hitting **OK** from this dialog. This boundary rectangle can be modified in three different ways.

- **DRAGGING** – Using the mouse, click near one of the four edges of the bounding rectangle and drag it to a new location. If clicking near a corner, both edges will be adjusted. If clicking in the center of the rectangle then the entire rectangle can be translated to a new location. When dragging edges to new locations, their corresponding values are automatically updated in the Edit Fields.
- **EDIT FIELDS** – Any one of the western, eastern, northern, or southern boundaries can be explicitly set by changing the values in their corresponding edit fields. As new values are entered the display in the small graphics window can be updated by tabbing or by clicking the cursor outside the current edit field.
- **ENCLOSE ALL DEMs** – This button can be used to force the edges of the bounding rectangle to correspond to the limits of the DEM files which have been added to this point. By default when a new DEM file is added the bounding rectangle is adjusted to enclose all DEMs.

The thinning factor can be used to reduce the number of elevation points read. A thinning factor of 2 means that every other row and column would be read, reducing the number of total points by a factor of 4. A factor of three means that every third row and column would be read reducing the total by a factor of 9, etc.

The elevation units toggle can be used to specify whether imported DEM points have meter or feet for units of elevation. If a DEMs base elevation units are feet and the toggle specified meters, all elevations are converted when reading. This is particularly important when trying to read two adjacent DEMs with different base elevation units. [Also see about transforming projections.](#)

NOTE: This option does not change the base planimetric units of the DEM. Make the elevation units consistent with the planimetric units in order to ensure that slopes are

computed properly when computing basin geometric parameters.

At the bottom of this dialog the total number of DEM points from all DEM files which have been added and the approximate number of points inside the bounding rectangle are displayed. These numbers can be used to determine how many points the system is capable of reading. For example, each DEM point requires 5 bytes of memory, so that if the project reads an entire 1:250,000 DEM with about 1.4 million points, $1.4 \text{ meg} * 5 \text{ bytes} = 7 \text{ meg}$ of memory would be required (in addition to whatever other memory being used by GMS). This means that the system would need at least 8 meg of RAM, or some type of virtual memory capabilities would be required to read in the entire DEM file.

This same dialog is used for all five types of DEMs supported in the GMS import options: USGS, ARC/INFO®, GRASS, DTED, and SDTS.

DEMs in Different UTM Zones

Occasionally two adjacent USGS DEM files will be read in but do not appear adjacent in the import dialog. This occurs because while the two DEMs are adjacent, they lie in different UTM zones. X coordinates within UTM zones repeat and therefore the DEMs do not lie adjacent to one another as they should. WMS does not contain the utility functions necessary to transform a DEM from one UTM coordinate zone to another. However, GMS, ARC/INFO® and possibly other GIS software can be used to convert from one zone to another.

Importing/Exporting GIS Grids

GMS includes an option to import and export grid files from/to either the GRASS or ARC/INFO (ArcView) geographic information systems formats.

Importing

Grids are imported using the **Open** command in the *File* menu.

With GRASS and ARC/INFO grid files, the grid and the attributes are saved to a single file. When a grid file is imported, GMS constructs the grid, and then reads in the attribute matrix as a [dataset](#).

When a grid in GRASS or ARC/INFO contains multiple attributes (datasets), each attribute is written to a separate grid file. In such cases, it is possible to read in one instance of the grid file to create a grid with a single dataset, and then read in the other grids as extra datasets on the first grid. This can be accomplished as follows:

1. Select the **Open** command from the *File* menu.
2. Choose either the GRASS or ARC/INFO file filter.
3. Select the grid file.
4. Select the **OK** button.

At this point, the first grid file is imported resulting in a grid with a single dataset. For the additional datasets, steps 1-5 are repeated but now GMS will detect that there is already a 2D grid in memory that matches the grid being imported and will ask whether wanting to replace the existing grid, or add the new grid as a dataset of the existing grid.

Exporting

Grids can be exported from GMS in the GRASS or ARC/INFO format by right-clicking on the grid in the [Project Explorer](#) and selecting the **Export** menu command. Only grids with equal row heights and equal column widths can be exported. When a grid is exported, the

grid and the active dataset are written to the GIS file. If multiple datasets are associated with the grid, each dataset should be made the active dataset and the grid should be exported repeatedly so that each dataset is written to a separate grid file.

See also

- [2D Grid Module](#)

Importing/Exporting Shapefiles

GMS has the capability to import and export shapefiles.

Shapefile files

When a shapefile is saved from ArcGIS, multiple files are saved. The files are described in the following table. When the shapefile (*.shp) is imported to GMS, the database file (*.dbf) and (*.prj) files are automatically imported at the same time.

File Extension	Description
*.shp	This file contains the geometry of the points, lines, or polygons.
*.dbf	This is a relational database file. The properties of the feature objects are stored in this file.
*.shx	This is an index file. It is ignored by GMS.
*.prj	Projection file [optional]. Contains the projection information for the data which GMS uses to project the data on-the-fly .

Import

Shapefiles are imported to GMS using **Open** command in the *File* menu and selecting the *.shp extension. Drag-and-drop is also supported. Shapefiles are handled in GMS by the [GIS module](#) and are listed in the [Project Explorer](#) under *GIS Layers*.

Export

GMS can export the following object types as shapefiles:

- [Feature Objects](#)
- [2D Scatter points](#)
- [3D Scatter points](#)
- [3D Grids](#)
- [UGrids](#)

- [TINs](#)
- [2D Meshes](#)

The *Export* command can be found by right-clicking on the object in the [Project Explorer](#).

Exporting Feature Objects

In GMS, a single coverage can contain points, nodes, arcs and polygons. Shapefiles, however, can only contain one type of attribute. Thus, when exporting a coverage as a shapefile, GMS can export up to three shapefiles depending on the type of objects in the GMS coverage. For example, if the GMS coverage contains arcs, points and nodes, export the arcs to one shapefile and the points and nodes to a separate point shapefile. It is possible to control which shapefiles GMS will create when more than one is possible. The names for the shapefiles come from the prefix listed at the top of the dialog, appended with "_pts" for the point shapefile, "_arcs" for the arc shapefile, and "_polys" for the polygon shapefile.

With the current version of GMS, only steady state data can be exported to a shapefile. Transient properties are not saved to the file.

The table of attributes that is exported matches the table that is displayed in the properties dialog when editing feature objects.

Currently, only one coverage at a time can be exported to shapefiles.

Converting Shapefiles to Other Object Types

Shapefiles can be converted to the following types of objects:

- [Feature Objects](#)
- [2D Scatter points](#)
- [3D Scatter points](#)
- [UGrids](#)

Conversion to Feature Objects

When converting a shapefile to feature objects the [GIS to Feature Objects Wizard](#) is used.

Shapefile Properties

The tables below indicate how GMS imports and exports shapefile properties. A "type" field must exist as an attribute when importing so GMS knows what kind of attribute to assign to the object. If the "type" field is not found, GMS will import the objects as generic objects without properties and the *Map Shapefile Properties* dialog will not appear.

A single shapefile may contain objects with different attribute types. Different attribute types require different fields, as shown in the tables. The X's in the table indicate which fields correspond with which attribute types. GMS writes -999 to empty cells when exporting because shapefiles have no way of flagging "null" or "no data" fields. If a field is not required based on the attribute types of the objects to be exported, the field will not be included.

GMS only supports importing of steady state data (one moment in time) from shapefiles.

MODFLOW/MT3D Local Sources Sinks Coverage

For MODFLOW/MT3D local source/sink coverages, if a node is attached to more than one arc, it can have more than one attribute type. When GMS exports these nodes, it exports one node for every attribute type the node has. So the shapefile might end up with several points in the same location, each with different properties. When importing, GMS will resolve all nodes found in the same location to one node and assign the node the union of the properties of all the nodes.

Note that the following options only work for steady state data. Transient well data can be imported using the pumping well data file formats.

Type	Z	Cond	Elev	Stage	Flux	Screentop	Screenshot	Beginlayer	Endlayer
Generic	X								
Shead	X		X					X	X
Sconc	X							X	X
Ghead	X	X	X					X	X
Drn	X	X	X					X	X
Riv	X	X	X	X				X	X
Well	X				X	X	X	X	X

Point Properties For MODFLOW/MT3D Local Source/sink Coverage.

Type	Z	Elev	Stage	Topelev	Botelev
Shead	X	X			
Sconc	X				
Ghead	X	X			
Drn	X	X			
Riv	X	X	X		
Strm	X		X	X	X

Node Properties For MODFLOW/MT3D Local Source/sink Coverage.

Type	Cond	Elev	Stage	Beginlayer	Endlayer
Generic					
Shead		X		X	X
Sconc				X	X
Ghead	X	X		X	X
Drn	X	X		X	X
Riv	X	X	X	X	X

Polygon Properties for MODFLOW/MT3D Local Source/sink Coverage.

MODFLOW/MT3D Areal Coverage

The fields exported for MODFLOW/MT3D layer coverages depend on what properties are defined for the polygons. They also depend on which flow package (LPF, BCF or HUF) is selected in the *Coverage Properties* dialog. Similarly when importing GMS looks for the appropriate fields based on the selected flow package.

The following table lists the attributes that go with each flow package.

Shapefile Field	Meaning	LPF	BCF	HUF
Type	The attribute type ("Layer")	X	X	X
Topelev	Top Elevation	X	X	X
Botelev	Bottom Elevation	X	X	X
Trans	Transmissivity		X	
Kh	Horizontal hydraulic conductivity	X	X	
KV	Vertical hydraulic conductivity	X		
Leak	Leakance		X	
Hanis	Horizontal Anisotropy	X		
Vanis	Vertical Anisotropy	X		
Specstore	Specific storage	X		
Specyield	Specific yield	X		
Pstore	Primary storage coefficient		X	
Sstore	Secondary storage coefficient		X	
Wetdry	Wet/dry flag	X	X	X
Zonecode	Zone code	X	X	X
Porosity	Porosity	X	X	X
Longdisp	Longitudinal dispersivity	X	X	X
Bulkdens	Bulk density	X	X	X
Imporosity	Immobile porosity	X	X	X
Material	Material	X		

Polygon Properties for MODFLOW/MT3D Layer Coverage.

Observation Coverage

When importing shapefiles into an observation coverage, information should exist in the *Int* (interval) and *Conf* (confidence) fields, or in the *Stdev* (standard deviation) field but not both. The confidence value should be an integer between 0 and 100 (i.e., 95 means 95% confidence). GMS will assign default values if there is any information missing.

Type	Name	Z	Layer	Value	Int	Conf	Stdev
Obs	X	X	X	X	X	X	X

Point Properties for Observation Coverage.

See also

- [Feature Objects](#)

Shapefiles

One of the most common methods for creating feature objects is to import a shapefile. The concept of a shapefile was established by Environmental Systems Research Institute (ESRI) in their ArcView® program and it has become the defacto standard for sharing GIS vector data (points, lines, and polygons).

A shapefile is actually comprised of three or more files. The primary file is the *.shp and it contains the geometric information (coordinates and if necessary connectivity of the points, lines, polygons). The *.dbf file is a standard database file and stores the attributes of the feature objects. Finally, there will be a *.shx file which is an indexing file. There may be a few other files that accompany the shapefile and so always move them around together if copying or moving them to a new directory.

Only one theme, or type of feature, can exist in a shapefile. For example, it is not possible to store points and polygons in the shapefile, or streams and basin boundaries, so it may be required to import multiple files to make up the drainage coverage in WMS.

The shapefile feature type will be displayed in the Project Explorer as follows:

	Lines
	Points
	Polygons

XMS includes all of the tools necessary to import shapefiles and convert the geometric and attribute information into feature objects. This can be done by directly opening the shapefile and converting to feature objects in the active coverage or by loading the shapefile in the GIS module.

See also

- [GIS Module \(GMS\)](#)
- [GIS Module \(SMS\)](#)
- [GIS Module \(WMS\)](#)

- [Importing Shapefiles \(WMS\)](#)

Import From Database

The *Database Import Wizard* allows accessing data stored in a database and importing it. The wizard is invoked by selecting the **Import from Database** command from the *File* menu. The data types that can be imported by the *Database Import Wizard* are the same data types that are supported by the [File Import Wizard](#).

The *Database Import Wizard* has four steps:

Step 1 – Connecting to a Database

Step 1 of the wizard sets up a connection to a database. To connect to a database either on the same computer or on a network press the **Connect to Database** button. Once a database connection is created, a path to the database and the different tables in the database are displayed. When a table is selected its columns are displayed along with the number of rows in that table.

Step 2 – Querying Information from a Database Table

Step 2 gives the option to create, copy, delete, and import queries that retrieve data from a database. To help in writing the queries, the tables in the database are displayed, as well as the columns in the selected table.

SQL Basics

The query is an SQL (Structured Query Language) statement. The SQL statement is entered in the *Query SQL statement* edit field. An example of an SQL statement would be: “SELECT x, y, z, toluene FROM multipledatasets”. This statement means that columns x, y, z, and toluene from the table multipledatasets will be retrieved from a database. SQL statements are case sensitive. SQL statements also require brackets around table or column names that have spaces. For example, to query data from a table titled “x

coordinate” in the SQL statement it would be written as [x coordinate]. A full explanation of SQL is beyond the scope of this document.

A short description for each query can be written in the *Query description* edit field. The **New** button creates a new query that has a default name, description, and SQL statement. The **Copy** button creates a copy of the currently selected query. The **Delete** button deletes the currently selected query.

The defined queries are saved automatically by GMS in a file called gmsquery.ini, located in the folder where GMS is installed. The **Import** button allows importing a list of queries from any file that follows the same format as the gmsquery.ini file.

Step 3 – Viewing the Results of the Query

Step 3 displays the results of the database query. Only the first 20 rows are displayed in a spreadsheet. If the results are not what were wanted, go back to Step 2 and modify the query.

Step 4 – Assigning Column Types

The first 20 lines of the file are displayed in a spreadsheet according to the file outline specified in step 1. This step selects what kind of data to be imported (see [Supported File Formats](#)). A "no data flag" can be specified for the file. This is a number that, when encountered in the file, tells GMS to mark the value as "NULL" or "no data".

The data in the columns are identified by selecting the type in the combo box at the top of each column in the spreadsheet. If a row of headings exists, GMS will automatically select the proper type if it recognizes the heading. Otherwise they are *Not Mapped* by default. The available column types changes depending on the GMS data type selected. Certain column types must be mapped for each file format before progressing to the next step in the wizard. The name of each column is changed by editing the header cell.

After the data have been imported, the [coordinate transformation](#) tools can be used to transform and translate the data.

Get Online Maps

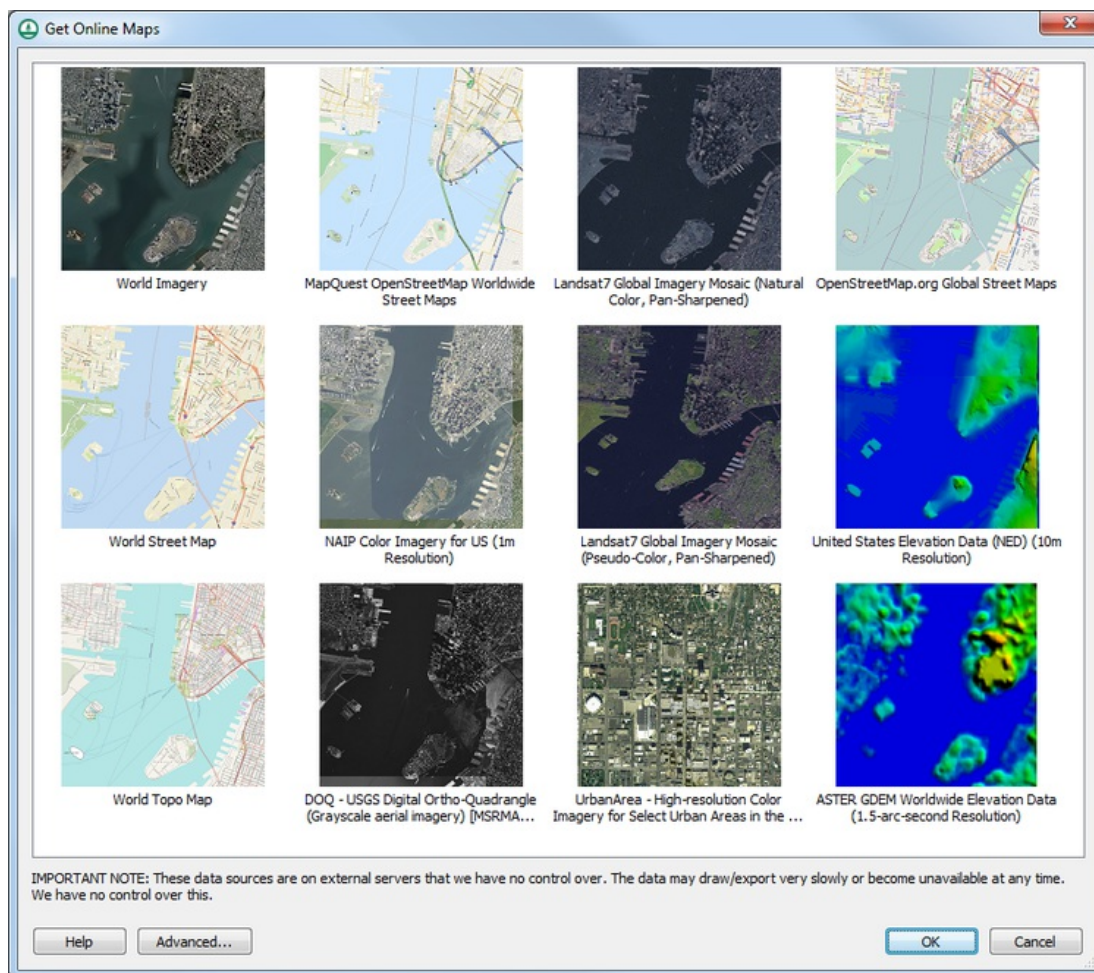

Get Online Maps dialog.

The **Get Online Maps** button allows selecting online data from a variety of different sources. Once online maps has been selected, the data resolution will be automatically adjusted based on the zoom parameters. Online maps can only be viewed in plan view.

Online maps are raster datasets that can contain imagery, elevation, or land use information. When online maps is available, right-click on each of the map items  in the Project Explorer to convert them to static images that can be saved to the local hard drive. It is possible to convert or interpolate online maps containing elevation data to various elevation formats.

Note that online data sources are on external servers that the XMS software has no control

over. The data may draw/export very slowly or become unavailable at any time. The XMS software has no control over this.

The **Advanced** button allows selecting from other data sources and to use other online data query functions that may not be fully supported. In the *Advanced* dialog, the **Add Sources From File** button allows adding new Web Map Service (WMS) sources from an external text file.

More information about the various types of online data can be found by visiting the following links:

- [NED data – USGS](#)
- [ASTER and SRTM data – USGS & NASA](#)
- [NLCD and CORINE \(European\) Land Cover data](#)
- [World Imagery More Info](#)
- [World Street Maps More Info](#)
- [World Topo Maps More Info](#)
- [MapQuest OpenStreetMap Worldwide Street Maps](#)
- [USA Topo Maps More Info](#)
- Other data sources-Geologic data, land cover, etc. (use the advanced button)

Exporting to a File

An online map can be exported to a file and loaded into the project. Do this if wanting to save a local copy and not be dependent on internet access. Also, there may be more commands and options available with a local file, such as interpolation or conversion to other object types, than with online maps.

Related Topics

- [GIS Conversion and Editing](#)

Online Groundwater Models

Some sources for downloadable groundwater models:

- [HydroShare](#): Free, public site that is part of [CUAHSI](#).
- [Data.gov](#): Government-only models.

Exporting Non-native GMS Files

GMS can export files that can be used in other software. There are two methods to export data from GMS. Data can be exported through the *Save As* dialog or by right-clicking on items in the [Project Explorer](#).

Exporting through the Save Dialog

The file types that can be exported are shown in the table below. To export a particular file type, the file filter corresponding to that file type should be selected in the *Save* dialog.

File Type	File Ext	Description
Image files	*.bmp, *.jpg, *.png, *.tif	Saves the graphics window as an image of the specified type.
Google Earth KMZ	*.kmz	Exports raster or vector kmz files for rendering in Google Earth.
Arc Hydro Groundwater Geodatabase	*.mdb	Exports boreholes, borehole cross sections, and solids to a geodatabase consistent with the Arc Hydro Groundwater data model.

Exporting from the Project Explorer

Items in the [Project Explorer](#) can be exported to different formats by right-clicking on an item and selecting the **Export** command. The table below lists the file formats that will be shown depending on the type of [Project Explorer](#) object selected:

Project Explorer Object	File Ext	Description
TINs	*.tin, *.shp	Text GMS TIN File, Polygon Shapefile, Point Shapefile
Boreholes	*.txt, *.bor	Text Tab Delimited Borehole File, Text GMS Borehole File
Solids	*.sol, *.vtu, *.vtk	Text GMS Solid File, VTK Binary or ASCII XML File, VTK ASCII Legacy File
2D Mesh Data	*.2dm, *.fem, *.shp	Text GMS 2D Mesh File, FEFLOW ASCII FEM File, Polygon Shapefile, Point Shapefile
2D Grid Data	*.2dg, *.asc	Text GMS 2D Grid File, ARC/INFO Ascii Grid Files
2D Scatter Sets	*.xy, *.txt, *.shp	Text GMS 2D Scatter Point File, Text Tab Delimited 2D Scatter Point File, Shapefile
3D Mesh Data	*.3dm, *.fem	Text GMS 3D Mesh File, FEFLOW ASCII FEM File
3D Grid Data	*.3dg, *.shp, *.case	Text GMS 3D Grid File, Shapefile, Ensignt Gold File
3D Scatter Sets	*.xyz, *.txt, *.shp	Text GMS 3D Scatter Point File, Text Tab Delimited 3D Scatter Point File, Shapefile
Coverages	*.map, *.shp, *.mif	GMS Map File, Shapefile, MapInfo Interchange File
Datasets	*.dat, *.dat, *.h5	Binary Dataset Files, ASCII Dataset Files, HDF5 Dataset File
Particle Sets	*.txt	Text Tab Delimited Pathlines
UGrids	(various)	See Exporting UGrids

Multiple Objects

If multiple objects are selected and they are all of the same type, they will all be exported to the same text file.

Folders

If a folder of objects is selected, then all of the geometric objects in the folder will be exported. Datasets will not be exported. If there are subfolders in the folder, all of the geometric objects will be recursively exported in all subfolders.

Images

An image is typically a scanned map or aerial photo in TIFF, PNG, or JPEG format. Images can be imported to GMS and displayed in the background to aid in the placement of objects as they are being constructed or simply to enhance a plot. Images can also be draped or "texture mapped" onto a [TIN](#), [2D grid](#), [2D mesh](#), or the top of a [3D grid](#) or [3D mesh](#).

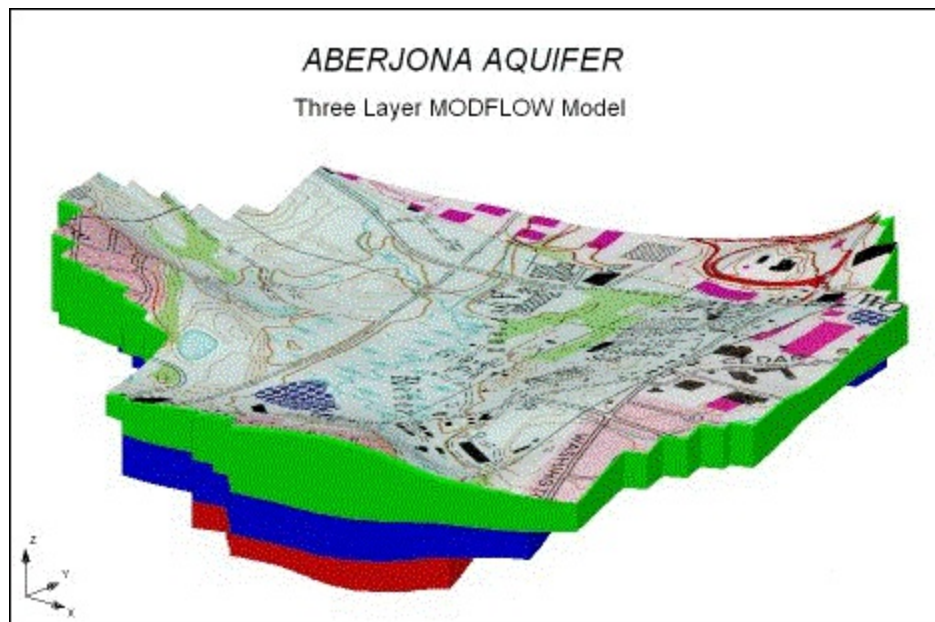

Scanned USGS Quad Map Texture Mapped to the Top of a 3D Grid.

Image display options are changed in the [Project Explorer](#). The options are as follows:

- **Visibility** – The Visibility of an Image is turned off by toggling the check box next to the image in the Project Explorer.
- **Transparency** – The Transparency of the images can be changed by right-clicking on the image folder in the Project Explorer and selecting the **Transparency** command.
- **Crop Collar** – USGS quad sheet collars can be removed from an image by right-clicking on an image in the Project Explorer and selecting the **Crop Collar** Command.

Getting Images via Online Maps

Free imagery can be obtained from the internet via the [Get Online Maps](#) feature. A local image file can be created from an online map via the *Export* command.

Importing an Image

Images are read into GMS by using the *File* | **Open** command. GMS supports many different image file types.

Image Pyramids

Image pyramids can be created when an image is imported into GMS. Image pyramids are multiple resolution copies of the original image that are created and saved to speed up display. With pyramids, a lower resolution copy of the image displays quickly when drawing the entire image. When zooming in, copies of the original image resampled at finer resolutions are then drawn. This option allows for optimal performance and clear image display.

See [Image Pyramids](#) for more information.

Multiple Images

GMS allows more than one image at a time; however, when doing so make certain that each image is in the same coordinate system.

Geo-Referenced Images

Some images have the coordinate system embedded in the file. Also, some images will have a separate file called a world file (for example: a tiff world file, *.tfw). These files are "geo-referenced." When these files are opened GMS automatically registers the image to the real world coordinate location specified. In the case where a separate world file is used, GMS will automatically find it and register the image if the world file has the same filename prefix as the image file and is in the same folder.

If the image file is not geo-referenced then register the image manually. (See [Registering an](#)

Image)

When the GMS project is saved, a link to the image is saved in the project file, along with the current image registration information so that the image is re-registered to the same coordinates every time the project is opened. The original image file and world file (if one exists) are not altered.

Exporting Images

An image can be exported by right-clicking on the image in the Project Explorer and selecting the **Export** command. When exporting, the image file type and the resolution can be specified. Only the image which is open in GMS is exported, not the entire Graphics Window.

The entire Graphics Window can also be saved to an image file via the *File* | **Save As** command. A number of different image file types are supported such as: BMP, PNG, JPG, and TIF.

Texture Mapping Images

GMS allows draping an image over the top of a TIN, grid, or mesh. However, only the first image listed in the project explorer will be texture mapped onto the TIN, grid, or mesh. Change the order of the images in the Project Explorer by selecting the image and dragging it to a new location in the Project Explorer.

Image Properties

The *Image Properties* dialog can be opened by double-clicking on an image in the Project Explorer. This dialog displays information about the image, such as name, path, type, pixel size, etc.

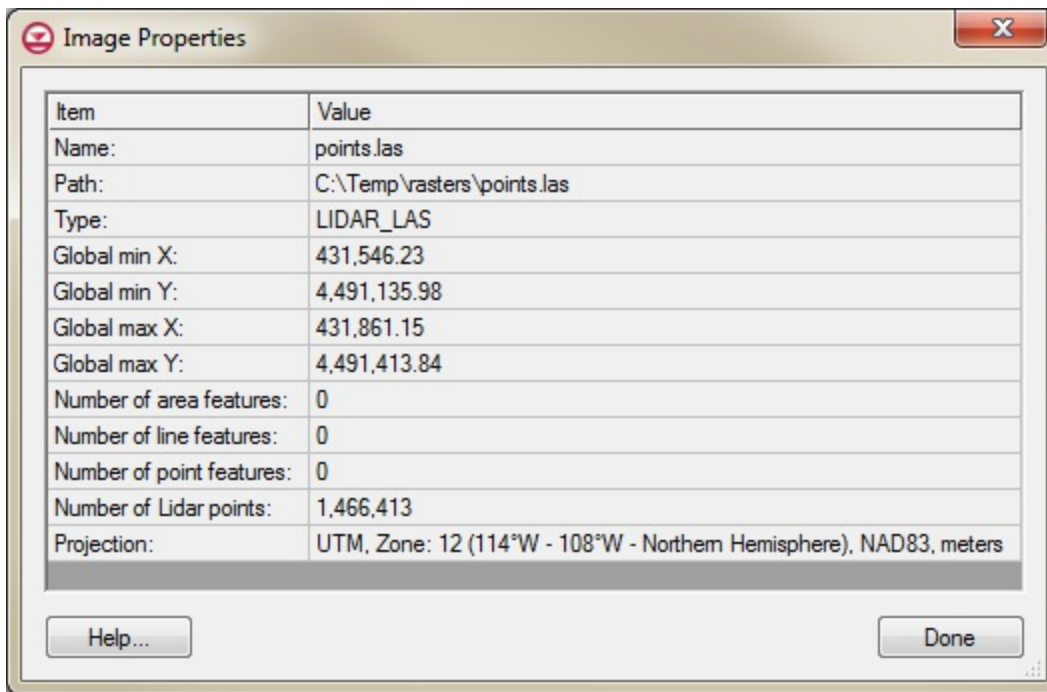

Example of the Image Properties dialog

DEMs / Rasters

- See [Rasters](#).

Registering an Image

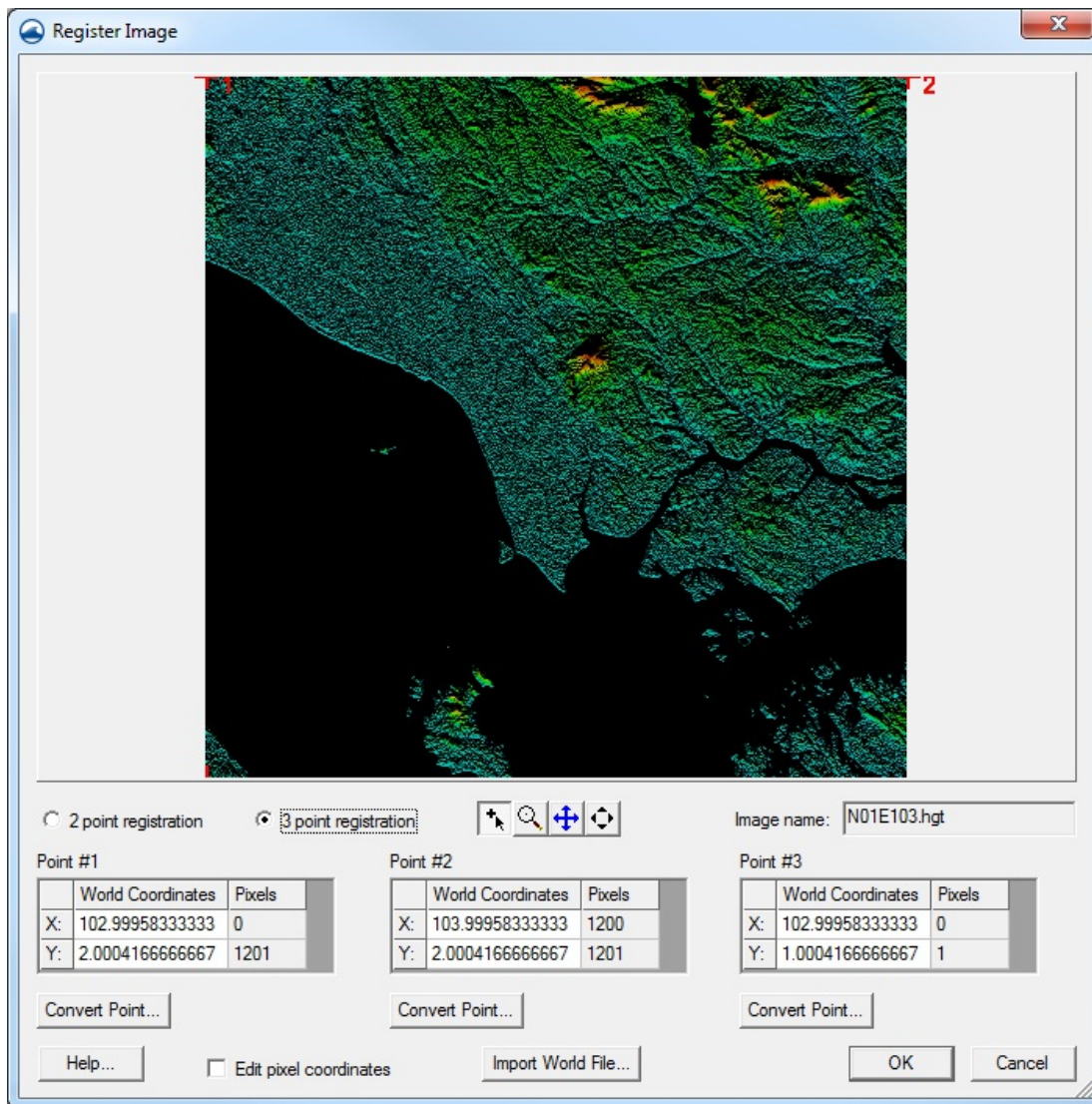

Example of the Register Image dialog.

If an image file is not geo-referenced then it's necessary to define the coordinate system of the image. The *Register Image* dialog allows specifying the coordinate system for the image. When an image is opened, if the image is not self-referenced, XMS attempts to find world file with the same name as the image (*.wld or *.jpgw extension). If neither of these is found, the *Register Image* dialog opens.

What is Image Registration?

Before an image can be displayed, the image must be "registered" or geo-referenced. Registering an image involves identifying points on the image corresponding to locations with known real world (XY) coordinates. Once these points are identified, they are used to scale and translate the image to the proper location when it is drawn with the other objects in the Graphics Window. If an image is not registered properly, any objects which are created using the background image as a guide will have the wrong coordinates.





Register Image Dialog

An image is registered using the *Register Image* dialog. The main feature of the *Register Image* dialog is a large window in which the image is displayed. Two or three points (shown by "+" symbols) are also displayed in the window. These points are used to identify locations with known real world coordinates. The real world coordinates (X,Y) and image coordinates (U,V) of the registration points are listed in edit fields below the image. The points are moved to the desired locations on the image by dragging the points using the tools described below. Once the points are located, the real world coordinates can be entered in the corresponding edit fields. The dialog contains the following options:

- **2 point or 3 point registration** – Two point registration rotates and uniformly scales an image. Three point registration allows for non-uniform scaling to account for some parallax.
- **Import World File** – Used to import a TIFF world file (*.tfw). A TIFF world file has the information needed to set the (X,Y) and (U,V) coordinates in order to place the image in the correct world coordinates.
- **Image name** – Used to associate a name with the file. This name will appear in the project explorer.

Register Image Dialog Tools

The following tools can be used to help position the registration points:

Tool	Tool Name	Description
	Select Point Tool	The Select Point tool is used to select and drag register points to a location on the map for which real coordinates are known so that they can be entered in the corresponding XY edit fields.
	Zoom Tool	In some cases, it is useful to magnify a portion of the image so that a registration point can be placed with more accuracy. The Zoom tool is used to zoom in a portion of the image.
	Pan Tool	After zooming in on a portion of the image, the Pan tool is used to pan the image vertically or horizontally.
	Frame Macro	The Frame macro is used to automatically center the entire image within the drawing window of the dialog after panning and zooming in on a specific location.

Import World File

The **Import World File** button can be used to automatically define the registration data. A world file is a special file associated with a previously registered image that is exported from [ArcView®](#) or [Arc/Info®](#). The file contains registration data that can be used to register the image.

Saving/Reading Image Registration Data

When a project file is saved, a link to the image is saved in the project file, along with the current image registration information so that the image is re-registered to the same coordinates every time the project is opened. The original image file and world file (if one exists) are not altered.

Convert Point Coordinate System

The x, y coordinates of each register point must be specified. If there are (x,y) coordinates in a different coordinate system than the project, the coordinates will need to be converted.

GMS Point Conversion

The **Convert Point** button in the image registration dialog will allow converting the coordinates.

SMS Point Conversion

The [Single Point Conversion](#) command in the *Edit* menu can be helpful if it becomes

necessary to convert between any two coordinate systems. Perform this conversion and record the locations in the correct coordinate system prior to entering the registration dialog.

An alternative approach is to convert the coordinate system after importing by right-clicking on the image in the [Project Explorer](#) and choosing **Coordinate Conversion** from the right-click menu.

WMS Point Conversion

The [Single Point Conversion](#) command in the *Edit* menu can be helpful if it becomes necessary to convert between any two coordinate systems. Perform this conversion and record the locations in the correct coordinate system prior to entering the registration dialog.

See also

- [Image Pyramids](#)
- [Import from Web](#)

KMZ files

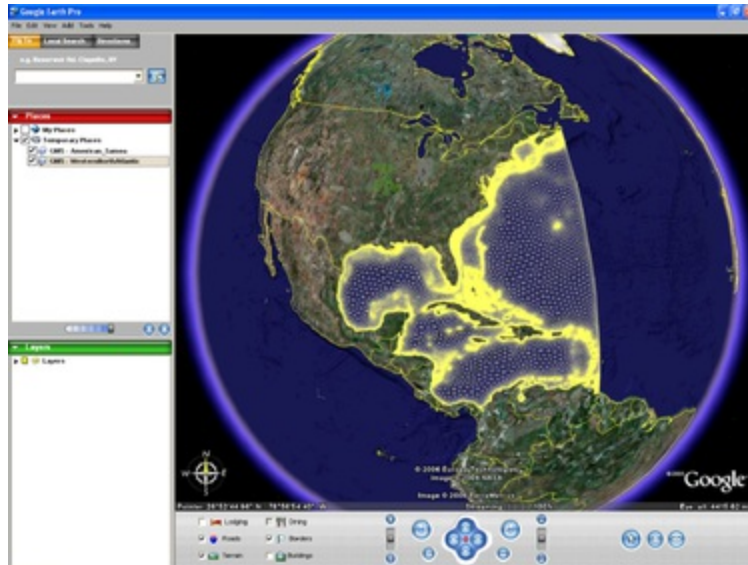

A 2D Mesh inside Google Earth

XMS software can export KMZ files. [KMZ](#) files can be imported into [Google Earth](#).

KMZ files can be imported into [GMS](#), [SMS](#), and [WMS](#).

Raster vs. Vector

The KMZ file format supports both vector data (lines, points, polygons, triangles etc.) and raster data (images). When exporting raster data, the image shown in the XMS main graphics window is saved as a PNG image file with georeferencing data. The data is clipped to match the window bounds of the current view. When exporting vector data, all data displayed, as specified by the display options and project explorer, is exported to a vector KMZ file. The following versions of XMS software support vector export:

- GMS – 7.1 and above
- SMS – 10.1 and above
- WMS – 8.1 and above

How To Export – Screen Capture

- The project must be in plan view before exporting a KMZ file.
- Export a KMZ file by using the standard *File* | **Save As** dialog and selecting either the *Google Earth© Raster KMZ File (*.kmz)* or *Google Earth© Vector KMZ File (*.kmz)* option in the *Save as type* field.
- To specify a resolution higher than the screen resolution:
 - GMS – Select the **Options** button in the *Save As* dialog.
 - SMS – Change the copy to clipboard scale factor in the [Preferences dialog](#)

The background color is made transparent in the exported KMZ file so the Earth can be seen through the overlaid image in Google Earth©.

How To Export – Transient Data Animation

Export a KMZ transient data animation using the [Film Loop Wizard](#). This will export a series of raster images which can be animated in Google Earth©. The background color can be specified in the [Film Loop Wizard](#). It is recommended that the option for no background be used so the Earth can be seen through the overlaid image in Google Earth©. The project must be in plan view to export a KMZ transient data animation.

By default, Coordinated Universal Time (UTC) is assumed when exporting KMZ files. An offset from UTC can be specified. A list of time zone offsets from UTC is given here.

See "Viewing a Timeline" on page 90 of the [Google Earth© user Guide](#) or [here](#) for an explanation of how to change the time zone used by Google Earth©.

Coordinate System

KMZ files contain latitude and longitude information to define the location of the image. If the current coordinate system type is a projection, like [UTM](#) for example, and not a [geographic system](#) (which uses latitude and longitude), XMS will attempt to determine the

latitude and longitude using coordinate conversion. It's possible that the coordinate conversion may fail, or that the distortion from converting from the current coordinate system to a [geographic system](#) is too high. In either case, XMS will issue a warning.

Transparency

The background color is made transparent in the exported PNG image which is in the KMZ file. This makes it so the Earth can be seen through the overlaid image.

See Also

- [Official Google Earth website](#)
- [KML documentation](#)

GeoStudio Import

GMS can support GeoStudio (*.gsz) files created using the GeoStudio software. Typically the file may contain data for a 2D mesh and materials. The file can be imported to work with the SEEP2D or UTEXAS models.

Importing a GeoStudio file

A GeoStudio (*.gsz) file may be opened from either the *File* | **Open** menu command or by drag-dropping the file into the GMS window. A dialog similar to the figure below will appear asking which SEEP or stability analyses to import. Only one of each method can be selected at once. Click **OK** when selections have been decided and GMS will display the imported information.

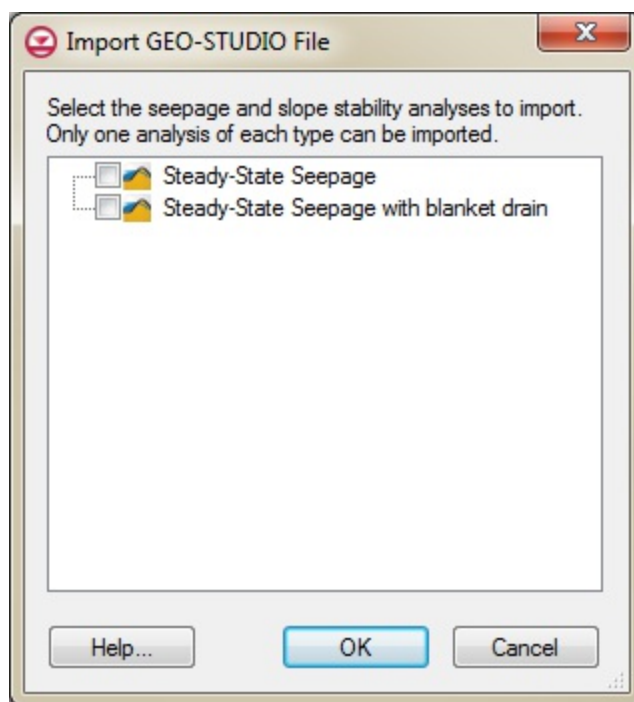

Import GeoStudio File dialog

9. Appendix

File Formats

GMS makes use of a wide range of formats for both input and output data.

GMS Project File

GMS can save entire projects as a project group file (*.gpr). Feature objects, projections, data objects, and other general settings will be saved. This file will reference the location of all external files (shapefiles, images, CAD files, etc.) used in the project. It is recommended that the project file be created where all of the external files are located. If the project file is moved, GMS will prompt for the location of any external files used in the project.

Import Formats

GMS can import various formats as documented on the [File Import Wizard Supported File Formats](#) article. Furthermore, GMS contains custom interfaces to import [shapefiles](#), [CAD data](#), [USGS DEMs](#), [GIS grids](#), [GeoStudio files](#), and [image files](#).

GMS Version 6.5 and Up

Starting at version 6.5 the GMS project file switched to a binary [HDF5](#) format. The format is proprietary and not documented but the user can examine the contents of the project file using a [free HDF5 browser](#) application. Some things in the project file, like TINs and Meshes, follow the [XMDF standard](#). Editing the HDF5 project file can corrupt it and make it unreadable by GMS and is highly discouraged.

Old GMS File Formats

This [PDF file](#) documents file formats used by GMS previous to version 6.5. Current versions of GMS can still read these files.

Dataset Files

ASCII Dataset Files

Datasets can be stored to either ASCII or binary files. The default format is binary.

Datasets can be saved in ASCII format by right clicking on the dataset in the [Project Explorer](#) and selecting the **Export** command from the pop up menu. For both file formats, multiple datasets can be stored in a single file and both scalar and vector datasets can be saved to the same file. The file format is identical for 2D and 3D datasets.

For scalar dataset files, one value is listed per vertex, cell, node, or scatter point. The points are listed sequentially in ascending order according to the ids of the nodes, points, vertices, or cells. For vector dataset files, one set of XYZ vector components is listed per vertex, cell, node, or scatter point. If necessary, a set of status flags can be included in the file. If the status flag is false (0), the corresponding item (node, cell, etc.) is inactive. If status flags are not included in the file, it is assumed that all items are active.

The ASCII Dataset file format is as follows:

```
DATASET           // File type identifier

OBJTYPE type     // Type of object  dataset is associated with

REFTIME reftime // A value corresponding to  beginning date/time of
dataset

BEGSCL           // Beginning  of scalar dataset

OBJID id         // Object id

ND numdata       // Number  of data values

NC numcells      // Number of cells or elements
```



```
NAME "name"          // Dataset name

ACTTS time           // Marks the active time step

MAPTS time           // Marks the time step which is mapped as elevations

TS istat time        // Time step of the following data

stat1                // Status flags

stat2

.

.

statnumcells

val1                 // Scalar data values

val2

.

.

valnumdata

// Repeat TS card for each time step

ENDDS                // End of dataset

BEGVEC               // Beginning of vector dataset

VECTYPE type         // Vector at node/gridnode or element/cell

OBJID id             // Object id
```

```
ND numdata      // Number of  data values

NC numcells     // Number of cells or elements

NAME "name"     // Dataset name

TS istat time   // Time step of the following  data

stat1          // Status  flags

stat2

.

.

statnumcells

vx1 vy1 vz1

vx2 vy2  vz2

.

.

vnumdata vnumdata vnumdata

// Repeat TS card for each time  step

ENDDS          // End of dataset

// Repeat BEGSCL and BEGVEC  sequences for each dataset
```

Sample ASCII Dataset File:

DATASET

OBJTYPE grid2d

REFTIME 945.348729

BEGSCL

ACTTS 1.00000000e+00

ND 8

NC 8

NAME "trichloroethylene"

TS 1 1.00000000e+00

0

0

0

1

1

1

1

0

0.00000000e+00

0.00000000e+00

0.00000000e+00

3.24000000e+00

4.39000000e+00

2.96000000e+00

7.48000000e+00

0.00000000e+00

ENDDS

BEGVEC

VECTYPE 0

ND 8

NC 8

NAME "velocity"

TS 1 5.00000000e+00

0

0

0

1

1

1

1

0

1.60000000e+01 1.60000000e+01 3.20000000e+01

6.40000000e+01 6.40000000e+01 1.28000000e+02

1.44000000e+02 1.44000000e+02 2.88000000e+02

1.96000000e+02 1.96000000e+02 3.92000000e+02

2.25000000e+02 2.25000000e+02 4.50000000e+02

9.21600000e+03 9.21600000e+03 1.84320000e+04

9.60400000e+03 9.60400000e+03 1.92080000e+04

9.80100000e+03 9.80100000e+03 1.96020000e+04

ENDDS

If variograms have been defined for a dataset or time step of a dataset within GMS, the variograms are saved in the dataset file. The variogram cards are not documented.

The card types used in the scalar dataset file format are as follows:

Card Type	DATASET
Description	File type identifier. Must be on first line of file. No fields.
Required	YES
Card Type	OBJTYPE
Description	Identifies the type of objects that the datasets in the file are associated with.
Required	YES. If card does not exist, the file can only be read through the Data Browser. The datasets would then be assigned to the objects corresponding to the active module.
Format	OBJTYPE type
Sample	OBJTYPE tin

Field	Variable	Value	Description
1	type	tin	TINs
		mesh2d	2D meshes
		grid2d	2D grids
		scat2d	2D scatter points
		mesh3d	3D meshes
		grid3d	3D grids
		scat3d	3D scatter points

Card Type	REFTIME
Decription	A value corresponding to the beginning date/time of the dataset.
Required	NO
Format	REFTIME reftime
Sample	REFTIME 3982.897459

Field	Variable	Value	Description
1	reftime	" +/- "	A value corresponding to the beginning date/time of the dataset.

Card Type	BEGSCL
Decription	Scalar dataset file identifier. Marks beginning of scalar dataset. No fields.
Required	YES

Card Type	BEGVEC
Decription	Vector dataset file identifier. Marks beginning of vector dataset. No fields.
Required	YES

Card Type	ACTTS
Decription	Used to mark the active dataset. The card should be placed after the BEGSCL or BEGVEC card of the active dataset and the active time step should be listed.
Required	NO
Format	ACTTS time
Sample	ACTTS 0.00

Field	Variable	Value	Description
1	time	" +/- "	The time corresponding to the active time step. Use 0.0 for steady state datasets.

Card Type	MAPTS
Decription	Used to mark the dataset which is mapped to the object elevations. The card should be placed after the BEGSCL or BEGVEC card of the mapped dataset and the mapped time step should be listed.
Required	NO
Format	MAPTS time
Sample	MAPTS 0.00

Field	Variable	Value	Description
1	time	" +/- "	The time corresponding to the mapped time step. Use 0.0 for steady state datasets.

Card Type	OBJID
Decription	The unique id of the object the dataset is associated with.
Required	This card is required for datasets associated with TINs and scatter point sets.
Format	OBJID id
Sample	OBJID 2383

Field	Variable	Value	Description
1	id	" + "	The unique id of the object.

Card Type	VECTYPE
Description	Identifies the type of vector data that will be read and where to apply it.
Required	This card is only required if the vector data is associated with elements/cells. If this card is not present, it is assumed that the data are associated with nodes/gridnodes.
Format	VECTYPE tpye
Sample	VECTYPE 0

Field	Variable	Value	Description
1	type	" 0,1 "	0 = The vectors will be applied to the nodes/gridnodes. 1 = The vectors will be applied to the elements/cells

Card Type	ND
Description	The number of data values that will be listed per time step. This number should correspond to the total number of vertices, nodes, cells centers (cell-centered grid), cell corners (mesh-centered grid), maximum node id (meshes) or scatter points.
Required	YES
Format	ND numdata
Sample	ND 10098

Field	Variable	Value	Description
1	numdata	" + "	The number of items. At each time step, numdata values are printed.

Card Type	NC
Description	This number should correspond to the maximum element id (meshes) or the number of cells (grids).
Required	YES
Format	NC numcells
Sample	NC 3982

Field	Variable	Value	Description
1	numcells	" + "	The number of elements or cells

Card Type	NAME
Description	The name of the dataset
Required	YES
Format	NAME "name"
Sample	NAME "Total head"

Field	Variable	Value	Description
1	"name"	str	The name of the dataset in double quotes.

Card Type	TS
Description	Marks the beginning of a new time step, indicates if stat flags are given, and defines the time step value, status flags, and scalar data values for each item.
Required	YES
Format	TS istat time stat1 stat2 . . stat numcells val1 val2 . . valnumdata
Sample	TS 1 12.5 0 1 1 1 34.5 74.3 58.4 72.9

License Agreement

XMS License Agreement

XMS LICENSE AGREEMENT

We understand that neither Aquaveo LLC nor its employees makes any warranty express or implied, or assumes any legal responsibility for the accuracy, completeness, or usefulness of the computer programs and documents herein ordered. We acknowledge that Aquaveo's liability for damages associated with these programs is limited to the amounts paid to Aquaveo. We understand that we may register the executable on only one machine per license purchased. We also agree to not make the program available to more persons, at any given time, than the number of licenses purchased. We agree to not distribute this program in unmodified or modified form, outside our organization without the written permission of Aquaveo. We agree that these programs may send information back to Aquaveo in order to enable a program on the computer in use. Additionally, parts of the software may be covered by one or more of the following agreements.

Boost Software License

Boost Software License - Version 1.0 - August 17th, 2003

Permission is hereby granted, free of charge, to any person or organization obtaining a copy of the software and accompanying documentation covered by this license (the "Software") to use, reproduce, display, distribute, execute, and transmit the Software, and to prepare derivative works of the Software, and to permit third-parties to whom the Software is furnished to do so, all subject to the following:

The copyright notices in the Software and this entire statement, including the above license grant, this restriction and the following disclaimer, must be included in all copies of the Software, in whole or in part, and all derivative works of the Software, unless such copies or derivative works are solely in the form of machine-executable object code generated by

a source language processor.

THE SOFTWARE IS PROVIDED "AS IS", WITHOUT WARRANTY OF ANY KIND, EXPRESS OR IMPLIED, INCLUDING BUT NOT LIMITED TO THE WARRANTIES OF MERCHANTABILITY, FITNESS FOR A PARTICULAR PURPOSE, TITLE AND NON-INFRINGEMENT. IN NO EVENT SHALL THE COPYRIGHT HOLDERS OR ANYONE DISTRIBUTING THE SOFTWARE BE LIABLE FOR ANY DAMAGES OR OTHER LIABILITY, WHETHER IN CONTRACT, TORT OR OTHERWISE, ARISING FROM, OUT OF OR IN CONNECTION WITH THE SOFTWARE OR THE USE OR OTHER DEALINGS IN THE SOFTWARE.

FTGL License Agreement

FTGL LICENSE AGREEMENT

<http://ftgl.wiki.sourceforge.net/> states: "FTGL is free software. You may use it, modify it and redistribute it under the terms of the MIT license or the GNU LGPL, at your option."

The MIT license link is to http://en.wikipedia.org/wiki/MIT_License, which states:

Copyright (c) <year> <copyright holders> Permission is hereby granted, free of charge, to any person obtaining a copy of this software and associated documentation files (the "Software"), to deal in the Software without restriction, including without limitation the rights to use, copy, modify, merge, publish, distribute, sublicense, and/or sell copies of the Software, and to permit persons to whom the Software is furnished to do so, subject to the following conditions:

The above copyright notice and this permission notice shall be included in all copies or substantial portions of the Software.

THE SOFTWARE IS PROVIDED "AS IS", WITHOUT WARRANTY OF ANY KIND, EXPRESS OR IMPLIED, INCLUDING BUT NOT LIMITED TO THE WARRANTIES OF MERCHANTABILITY, FITNESS FOR A PARTICULAR PURPOSE AND NON-INFRINGEMENT. IN NO EVENT SHALL THE AUTHORS OR COPYRIGHT HOLDERS BE LIABLE FOR ANY CLAIM, DAMAGES OR OTHER LIABILITY, WHETHER IN AN ACTION OF CONTRACT, TORT OR OTHERWISE, ARISING FROM, OUT OF OR IN

CONNECTION WITH THE SOFTWARE OR THE USE OR OTHER DEALINGS IN THE SOFTWARE.

Bugtrap

<http://www.codeproject.com/Articles/14618/Catch-All-Bugs-with-BugTrap>

The above URL states that Bugtrap is licensed as follows:

Microsoft Public License (MS-PL)

[OSI Approved License]

This license governs use of the accompanying software. If you use the software, you accept this license. If you do not accept the license, do not use the software.

1. Definitions The terms "reproduce," "reproduction," "derivative works," and "distribution" have the same meaning here as under U.S. copyright law. A "contribution" is the original software, or any additions or changes to the software. A "contributor" is any person that distributes its contribution under this license. "Licensed patents" are a contributor's patent claims that read directly on its contribution.

2. Grant of Rights

(A) Copyright Grant- Subject to the terms of this license, including the license conditions and limitations in section 3, each contributor grants you a non-exclusive, worldwide, royalty-free copyright license to reproduce its contribution, prepare derivative works of its contribution, and distribute its contribution or any derivative works that you create.

(B) Patent Grant- Subject to the terms of this license, including the license conditions and limitations in section 3, each contributor grants you a non-exclusive, worldwide, royalty-free license under its licensed patents to make, have made, use, sell, offer for sale, import, and/or otherwise dispose of its contribution in the software or derivative works of the contribution in the software.

3. Conditions and Limitations

(A) No Trademark License- This license does not grant you rights to use any

contributors' name, logo, or trademarks.

(B) If you bring a patent claim against any contributor over patents that you claim are infringed by the software, your patent license from such contributor to the software ends automatically.

(C) If you distribute any portion of the software, you must retain all copyright, patent, trademark, and attribution notices that are present in the software.

(D) If you distribute any portion of the software in source code form, you may do so only under this license by including a complete copy of this license with your distribution. If you distribute any portion of the software in compiled or object code form, you may only do so under a license that complies with this license.

(E) The software is licensed "as-is." You bear the risk of using it. The contributors give no express warranties, guarantees or conditions. You may have additional consumer rights under your local laws which this license cannot change. To the extent permitted under your local laws, the contributors exclude the implied warranties of merchantability, fitness for a particular purpose and non-infringement.

GNU Lesser General Public License

GNU LESSER GENERAL PUBLIC LICENSE

Version 2.1, February 1999

Copyright (C) 1991, 1999 Free Software Foundation, Inc. 51 Franklin Street, Fifth Floor, Boston, MA 02110-1301 USA Everyone is permitted to copy and distribute verbatim copies of this license document, but changing it is not allowed.

[This is the first released version of the Lesser GPL. It also counts as the successor of the GNU Library Public License, version 2, hence the version number 2.1.]

Preamble

The licenses for most software are designed to take away your freedom to share and change it. By contrast, the GNU General Public Licenses are intended to guarantee your freedom to share and change free software--to make sure the software is free for all its users.

This license, the Lesser General Public License, applies to some specially designated software packages--typically libraries--of the Free Software Foundation and other authors who decide to use it. You can use it too, but we suggest you first think carefully about whether this license or the ordinary General Public License is the better strategy to use in any particular case, based on the explanations below.

When we speak of free software, we are referring to freedom of use, not price. Our General Public Licenses are designed to make sure that you have the freedom to distribute copies of free software (and charge for this service if you wish); that you receive source code or can get it if you want it; that you can change the software and use pieces of it in new free programs; and that you are informed that you can do these things.

To protect your rights, we need to make restrictions that forbid distributors to deny you these rights or to ask you to surrender these rights. These restrictions translate to certain responsibilities for you if you distribute copies of the library or if you modify it.

For example, if you distribute copies of the library, whether gratis or for a fee, you must give the recipients all the rights that we gave you. You must make sure that they, too, receive or can get the source code. If you link other code with the library, you must provide complete object files to the recipients, so that they can relink them with the library after making changes to the library and recompiling it. And you must show them these terms so they know their rights.

We protect your rights with a two-step method: (1) we copyright the library, and (2) we offer you this license, which gives you legal permission to copy, distribute and/or modify the library.

To protect each distributor, we want to make it very clear that there is no warranty for the free library. Also, if the library is modified by someone else and passed on, the recipients should know that what they have is not the original version, so that the original author's reputation will not be affected by problems that might be introduced by others.

Finally, software patents pose a constant threat to the existence of any free program. We wish to make sure that a company cannot effectively restrict the users of a free program by obtaining a restrictive license from a patent holder. Therefore, we insist that any patent license obtained for a version of the library must be consistent with the full freedom of use

specified in this license.

Most GNU software, including some libraries, is covered by the ordinary GNU General Public License. This license, the GNU Lesser General Public License, applies to certain designated libraries, and is quite different from the ordinary General Public License. We use this license for certain libraries in order to permit linking those libraries into non-free programs.

When a program is linked with a library, whether statically or using a shared library, the combination of the two is legally speaking a combined work, a derivative of the original library. The ordinary General Public License therefore permits such linking only if the entire combination fits its criteria of freedom. The Lesser General Public License permits more lax criteria for linking other code with the library.

We call this license the "Lesser" General Public License because it does Less to protect the user's freedom than the ordinary General Public License. It also provides other free software developers Less of an advantage over competing non-free programs. These disadvantages are the reason we use the ordinary General Public License for many libraries. However, the Lesser license provides advantages in certain special circumstances.

For example, on rare occasions, there may be a special need to encourage the widest possible use of a certain library, so that it becomes a de-facto standard. To achieve this, non-free programs must be allowed to use the library. A more frequent case is that a free library does the same job as widely used non-free libraries. In this case, there is little to gain by limiting the free library to free software only, so we use the Lesser General Public License.

In other cases, permission to use a particular library in non-free programs enables a greater number of people to use a large body of free software. For example, permission to use the GNU C Library in non-free programs enables many more people to use the whole GNU operating system, as well as its variant, the GNU/Linux operating system.

Although the Lesser General Public License is Less protective of the users' freedom, it does ensure that the user of a program that is linked with the Library has the freedom and the wherewithal to run that program using a modified version of the Library.

The precise terms and conditions for copying, distribution and modification follow. Pay close attention to the difference between a "work based on the library" and a "work that uses the library". The former contains code derived from the library, whereas the latter must be combined with the library in order to run.

Terms and Conditions for Copying, Distribution and Modification

GNU LESSER GENERAL PUBLIC LICENSE

TERMS AND CONDITIONS FOR COPYING, DISTRIBUTION AND MODIFICATION

0. This License Agreement applies to any software library or other program which contains a notice placed by the copyright holder or other authorized party saying it may be distributed under the terms of this Lesser General Public License (also called "this License"). Each licensee is addressed as "you".

A "library" means a collection of software functions and/or data prepared so as to be conveniently linked with application programs (which use some of those functions and data) to form executables.

The "Library", below, refers to any such software library or work which has been distributed under these terms. A "work based on the Library" means either the Library or any derivative work under copyright law: that is to say, a work containing the Library or a portion of it, either verbatim or with modifications and/or translated straightforwardly into another language. (Hereinafter, translation is included without limitation in the term "modification".)

"Source code" for a work means the preferred form of the work for making modifications to it. For a library, complete source code means all the source code for all modules it contains, plus any associated interface definition files, plus the scripts used to control compilation and installation of the library.

Activities other than copying, distribution and modification are not covered by this License; they are outside its scope. The act of running a program using the Library is not restricted, and output from such a program is covered only if its contents constitute a work based on the Library (independent of the use of the Library in a tool for writing it). Whether that is true depends on what the Library does and what the program that uses the Library does.

1. You may copy and distribute verbatim copies of the Library's complete source code as you receive it, in any medium, provided that you conspicuously and appropriately publish on each copy an appropriate copyright notice and disclaimer of warranty; keep intact all the notices that refer to this License and to the absence of any warranty; and distribute a copy of this License along with the Library.

You may charge a fee for the physical act of transferring a copy, and you may at your option offer warranty protection in exchange for a fee.

2. You may modify your copy or copies of the Library or any portion of it, thus forming a work based on the Library, and copy and distribute such modifications or work under the terms of Section 1 above, provided that you also meet all of these conditions:

a) The modified work must itself be a software library.

b) You must cause the files modified to carry prominent notices stating that you changed the files and the date of any change.

c) You must cause the whole of the work to be licensed at no charge to all third parties under the terms of this License.

d) If a facility in the modified Library refers to a function or a table of data to be supplied by an application program that uses the facility, other than as an argument passed when the facility is invoked, then you must make a good faith effort to ensure that, in the event an application does not supply such function or table, the facility still operates, and performs whatever part of its purpose remains meaningful.

(For example, a function in a library to compute square roots has a purpose that is entirely well-defined independent of the application. Therefore, Subsection 2d requires that any application-supplied function or table used by this function must be optional: if the application does not supply it, the square root function must still compute square roots.)

These requirements apply to the modified work as a whole. If identifiable sections of that work are not derived from the Library, and can be reasonably considered independent and separate works in themselves, then this License, and its terms, do not apply to those sections when you distribute them as separate works. But when you distribute the same sections as part of a whole which is a work based on the Library, the distribution of the whole must be on the terms of this License, whose permissions for other licensees extend

to the entire whole, and thus to each and every part regardless of who wrote it.

Thus, it is not the intent of this section to claim rights or contest your rights to work written entirely by you; rather, the intent is to exercise the right to control the distribution of derivative or collective works based on the Library.

In addition, mere aggregation of another work not based on the Library with the Library (or with a work based on the Library) on a volume of a storage or distribution medium does not bring the other work under the scope of this License.

3. You may opt to apply the terms of the ordinary GNU General Public License instead of this License to a given copy of the Library. To do this, you must alter all the notices that refer to this License, so that they refer to the ordinary GNU General Public License, version 2, instead of to this License. (If a newer version than version 2 of the ordinary GNU General Public License has appeared, then you can specify that version instead if you wish.) Do not make any other change in these notices.

Once this change is made in a given copy, it is irreversible for that copy, so the ordinary GNU General Public License applies to all subsequent copies and derivative works made from that copy.

This option is useful when you wish to copy part of the code of the Library into a program that is not a library.

4. You may copy and distribute the Library (or a portion or derivative of it, under Section 2) in object code or executable form under the terms of Sections 1 and 2 above provided that you accompany it with the complete corresponding machine-readable source code, which must be distributed under the terms of Sections 1 and 2 above on a medium customarily used for software interchange.

If distribution of object code is made by offering access to copy from a designated place, then offering equivalent access to copy the source code from the same place satisfies the requirement to distribute the source code, even though third parties are not compelled to copy the source along with the object code.

5. A program that contains no derivative of any portion of the Library, but is designed to work with the Library by being compiled or linked with it, is called a "work that uses the Library". Such a work, in isolation, is not a derivative work of the Library, and therefore falls

outside the scope of this License.

However, linking a "work that uses the Library" with the Library creates an executable that is a derivative of the Library (because it contains portions of the Library), rather than a "work that uses the library". The executable is therefore covered by this License. Section 6 states terms for distribution of such executables.

When a "work that uses the Library" uses material from a header file that is part of the Library, the object code for the work may be a derivative work of the Library even though the source code is not. Whether this is true is especially significant if the work can be linked without the Library, or if the work is itself a library. The threshold for this to be true is not precisely defined by law.

If such an object file uses only numerical parameters, data structure layouts and accessors, and small macros and small inline functions (ten lines or less in length), then the use of the object file is unrestricted, regardless of whether it is legally a derivative work. (Executables containing this object code plus portions of the Library will still fall under Section 6.)

Otherwise, if the work is a derivative of the Library, you may distribute the object code for the work under the terms of Section 6. Any executables containing that work also fall under Section 6, whether or not they are linked directly with the Library itself.

6. As an exception to the Sections above, you may also combine or link a "work that uses the Library" with the Library to produce a work containing portions of the Library, and distribute that work under terms of your choice, provided that the terms permit modification of the work for the customer's own use and reverse engineering for debugging such modifications.

You must give prominent notice with each copy of the work that the Library is used in it and that the Library and its use are covered by this License. You must supply a copy of this License. If the work during execution displays copyright notices, you must include the copyright notice for the Library among them, as well as a reference directing the user to the copy of this License. Also, you must do one of these things:

- a) Accompany the work with the complete corresponding machine-readable source code for the Library including whatever changes were used in the work (which must be distributed under Sections 1 and 2 above); and, if the work is an executable linked with

the Library, with the complete machine-readable "work that uses the Library", as object code and/or source code, so that the user can modify the Library and then relink to produce a modified executable containing the modified Library. (It is understood that the user who changes the contents of definitions files in the Library will not necessarily be able to recompile the application to use the modified definitions.)

b) Use a suitable shared library mechanism for linking with the Library. A suitable mechanism is one that (1) uses at run time a copy of the library already present on the user's computer system, rather than copying library functions into the executable, and (2) will operate properly with a modified version of the library, if the user installs one, as long as the modified version is interface-compatible with the version that the work was made with.

c) Accompany the work with a written offer, valid for at least three years, to give the same user the materials specified in Subsection 6a, above, for a charge no more than the cost of performing this distribution.

d) If distribution of the work is made by offering access to copy from a designated place, offer equivalent access to copy the above specified materials from the same place.

e) Verify that the user has already received a copy of these materials or that you have already sent this user a copy.

For an executable, the required form of the "work that uses the Library" must include any data and utility programs needed for reproducing the executable from it. However, as a special exception, the materials to be distributed need not include anything that is normally distributed (in either source or binary form) with the major components (compiler, kernel, and so on) of the operating system on which the executable runs, unless that component itself accompanies the executable.

It may happen that this requirement contradicts the license restrictions of other proprietary libraries that do not normally accompany the operating system. Such a contradiction means you cannot use both them and the Library together in an executable that you distribute.

7. You may place library facilities that are a work based on the Library side-by-side in a single library together with other library facilities not covered by this License, and distribute

such a combined library, provided that the separate distribution of the work based on the Library and of the other library facilities is otherwise permitted, and provided that you do these two things:

- a) Accompany the combined library with a copy of the same work based on the Library, uncombined with any other library facilities. This must be distributed under the terms of the Sections above.
- b) Give prominent notice with the combined library of the fact that part of it is a work based on the Library, and explaining where to find the accompanying uncombined form of the same work.

8. You may not copy, modify, sublicense, link with, or distribute the Library except as expressly provided under this License. Any attempt otherwise to copy, modify, sublicense, link with, or distribute the Library is void, and will automatically terminate your rights under this License. However, parties who have received copies, or rights, from you under this License will not have their licenses terminated so long as such parties remain in full compliance.

9. You are not required to accept this License, since you have not signed it. However, nothing else grants you permission to modify or distribute the Library or its derivative works. These actions are prohibited by law if you do not accept this License. Therefore, by modifying or distributing the Library (or any work based on the Library), you indicate your acceptance of this License to do so, and all its terms and conditions for copying, distributing or modifying the Library or works based on it.

10. Each time you redistribute the Library (or any work based on the Library), the recipient automatically receives a license from the original licensor to copy, distribute, link with or modify the Library subject to these terms and conditions. You may not impose any further restrictions on the recipients' exercise of the rights granted herein. You are not responsible for enforcing compliance by third parties with this License.

11. If, as a consequence of a court judgment or allegation of patent infringement or for any other reason (not limited to patent issues), conditions are imposed on you (whether by court order, agreement or otherwise) that contradict the conditions of this License, they do not excuse you from the conditions of this License. If you cannot distribute so as to satisfy

simultaneously your obligations under this License and any other pertinent obligations, then as a consequence you may not distribute the Library at all. For example, if a patent license would not permit royalty-free redistribution of the Library by all those who receive copies directly or indirectly through you, then the only way you could satisfy both it and this License would be to refrain entirely from distribution of the Library.

If any portion of this section is held invalid or unenforceable under any particular circumstance, the balance of the section is intended to apply, and the section as a whole is intended to apply in other circumstances.

It is not the purpose of this section to induce you to infringe any patents or other property right claims or to contest validity of any such claims; this section has the sole purpose of protecting the integrity of the free software distribution system which is implemented by public license practices. Many people have made generous contributions to the wide range of software distributed through that system in reliance on consistent application of that system; it is up to the author/donor to decide if he or she is willing to distribute software through any other system and a licensee cannot impose that choice.

This section is intended to make thoroughly clear what is believed to be a consequence of the rest of this License.

12. If the distribution and/or use of the Library is restricted in certain countries either by patents or by copyrighted interfaces, the original copyright holder who places the Library under this License may add an explicit geographical distribution limitation excluding those countries, so that distribution is permitted only in or among countries not thus excluded. In such case, this License incorporates the limitation as if written in the body of this License.

13. The Free Software Foundation may publish revised and/or new versions of the Lesser General Public License from time to time. Such new versions will be similar in spirit to the present version, but may differ in detail to address new problems or concerns.

Each version is given a distinguishing version number. If the Library specifies a version number of this License which applies to it and "any later version", you have the option of following the terms and conditions either of that version or of any later version published by the Free Software Foundation. If the Library does not specify a license version number, you may choose any version ever published by the Free Software Foundation.

14. If you wish to incorporate parts of the Library into other free programs whose distribution conditions are incompatible with these, write to the author to ask for permission. For software which is copyrighted by the Free Software Foundation, write to the Free Software Foundation; we sometimes make exceptions for this. Our decision will be guided by the two goals of preserving the free status of all derivatives of our free software and of promoting the sharing and reuse of software generally.

No Warranty

NO WARRANTY

15. BECAUSE THE LIBRARY IS LICENSED FREE OF CHARGE, THERE IS NO WARRANTY FOR THE LIBRARY, TO THE EXTENT PERMITTED BY APPLICABLE LAW. EXCEPT WHEN OTHERWISE STATED IN WRITING THE COPYRIGHT HOLDERS AND/OR OTHER PARTIES PROVIDE THE LIBRARY "AS IS" WITHOUT WARRANTY OF ANY KIND, EITHER EXPRESSED OR IMPLIED, INCLUDING, BUT NOT LIMITED TO, THE IMPLIED WARRANTIES OF MERCHANTABILITY AND FITNESS FOR A PARTICULAR PURPOSE. THE ENTIRE RISK AS TO THE QUALITY AND PERFORMANCE OF THE LIBRARY IS WITH YOU. SHOULD THE LIBRARY PROVE DEFECTIVE, YOU ASSUME THE COST OF ALL NECESSARY SERVICING, REPAIR OR CORRECTION.

16. IN NO EVENT UNLESS REQUIRED BY APPLICABLE LAW OR AGREED TO IN WRITING WILL ANY COPYRIGHT HOLDER, OR ANY OTHER PARTY WHO MAY MODIFY AND/OR REDISTRIBUTE THE LIBRARY AS PERMITTED ABOVE, BE LIABLE TO YOU FOR DAMAGES, INCLUDING ANY GENERAL, SPECIAL, INCIDENTAL OR CONSEQUENTIAL DAMAGES ARISING OUT OF THE USE OR INABILITY TO USE THE LIBRARY (INCLUDING BUT NOT LIMITED TO LOSS OF DATA OR DATA BEING RENDERED INACCURATE OR LOSSES SUSTAINED BY YOU OR THIRD PARTIES OR A FAILURE OF THE LIBRARY TO OPERATE WITH ANY OTHER SOFTWARE), EVEN IF SUCH HOLDER OR OTHER PARTY HAS BEEN ADVISED OF THE POSSIBILITY OF SUCH DAMAGES.

END OF TERMS AND CONDITIONS

How to Apply These Terms to Your New Libraries

If you develop a new library, and you want it to be of the greatest possible use to the public, we recommend making it free software that everyone can redistribute and change. You can do so by permitting redistribution under these terms (or, alternatively, under the terms of the ordinary General Public License).

To apply these terms, attach the following notices to the library. It is safest to attach them to the start of each source file to most effectively convey the exclusion of warranty; and each file should have at least the "copyright" line and a pointer to where the full notice is found.

```
<one line to give the library's name and a brief idea of what it
does.>
```

```
Copyright (C) <year> <name of author>
```

```
This library is free software; you can redistribute it and/or
modify it under the terms of the GNU Lesser General Public
License as published by the Free Software Foundation; either
version 2.1 of the License, or (at your option) any later version.
```

```
This library is distributed in the hope that it will be useful,
but WITHOUT ANY WARRANTY; without even the implied warranty of
MERCHANTABILITY or FITNESS FOR A PARTICULAR PURPOSE. See the GNU
Lesser General Public License for more details.
```

```
You should have received a copy of the GNU Lesser General Public
License along with this library; if not, write to the Free Software
Foundation, Inc., 51 Franklin Street, Fifth Floor, Boston, MA 02110-
1301 USA
```

Also add information on how to contact you by electronic and paper mail.

You should also get your employer (if you work as a programmer) or your school, if any, to sign a "copyright disclaimer" for the library, if necessary. Here is a sample; alter the names:

```
Yoyodyne, Inc., hereby disclaims all copyright interest in the library `Frob' (a library for
tweaking knobs) written by James Random Hacker.
```

<signature of Ty Coon>, 1 April 1990

Ty Coon, President of Vice

That's all there is to it!

Qt

Other Licenses Used in Qt

Qt contains some code that is not provided under the GNU General Public License (GPL), GNU Lesser General Public License (LGPL) or the Qt Commercial License Agreement, but rather under specific licenses from the original authors. Some pieces of code were developed by Nokia and others originated from third parties. This page lists the licenses used, names the authors, and links to the places where it is used.

Nokia gratefully acknowledges these and other contributions to Qt. We recommend that programs that use Qt also acknowledge these contributions, and quote these license statements in an appendix to the documentation.

See also: Licenses for Fonts Used in Qt for Embedded Linux

Copyright (c) 2001 Robert Penner All rights reserved.

Redistribution and use in source and binary forms, with or without modification, are permitted provided that the following conditions are met:

- Redistributions of source code must retain the above copyright notice, this list of conditions and the following disclaimer.
- Redistributions in binary form must reproduce the above copyright notice, this list of conditions and the following disclaimer in the documentation and/or other materials provided with the distribution.
- Neither the name of the author nor the names of contributors may be used to endorse or promote products derived from this software without specific prior written permission.

THIS SOFTWARE IS PROVIDED BY THE COPYRIGHT HOLDERS AND

CONTRIBUTORS "AS IS" AND ANY EXPRESS OR IMPLIED WARRANTIES, INCLUDING, BUT NOT LIMITED TO, THE IMPLIED WARRANTIES OF MERCHANTABILITY AND FITNESS FOR A PARTICULAR PURPOSE ARE DISCLAIMED. IN NO EVENT SHALL THE COPYRIGHT OWNER OR CONTRIBUTORS BE LIABLE FOR ANY DIRECT, INDIRECT, INCIDENTAL, SPECIAL, EXEMPLARY, OR CONSEQUENTIAL DAMAGES (INCLUDING, BUT NOT LIMITED TO, PROCUREMENT OF SUBSTITUTE GOODS OR SERVICES; LOSS OF USE, DATA, OR PROFITS; OR BUSINESS INTERRUPTION) HOWEVER CAUSED AND ON ANY THEORY OF LIABILITY, WHETHER IN CONTRACT, STRICT LIABILITY, OR TORT (INCLUDING NEGLIGENCE OR OTHERWISE) ARISING IN ANY WAY OUT OF THE USE OF THIS SOFTWARE, EVEN IF ADVISED OF THE POSSIBILITY OF SUCH DAMAGE.

Easing Equations by Robert Penner

OpenGL is a trademark of Silicon Graphics, Inc. in the United States and other countries.

QGLFormat

QGLFormat

QPlatformWindowFormat

QtScript is licensed under the GNU Library General Public License. Individual contributor names and copyright dates can be found inline in the code.

This library is free software; you can redistribute it and/or modify it under the terms of the GNU Library General Public License as published by the Free Software Foundation; either version 2 of the License, or (at your option) any later version.

This library is distributed in the hope that it will be useful, but WITHOUT ANY WARRANTY; without even the implied warranty of MERCHANTABILITY or FITNESS FOR A PARTICULAR PURPOSE. See the GNU Library General Public License for more details.

You should have received a copy of the GNU Library General Public License along with this library; see the file COPYING.LIB. If not, write to the Free Software Foundation, Inc., 51 Franklin Street, Fifth Floor, Boston, MA 02110-1301, USA.

QtScript Module

QtScript Module

WebKit is licensed under the GNU Library General Public License. Individual contributor names and copyright dates can be found inline in the code.

This library is free software; you can redistribute it and/or modify it under the terms of the GNU Library General Public License as published by the Free Software Foundation; either version 2 of the License, or (at your option) any later version.

This library is distributed in the hope that it will be useful, but WITHOUT ANY WARRANTY; without even the implied warranty of MERCHANTABILITY or FITNESS FOR A PARTICULAR PURPOSE. See the GNU Library General Public License for more details.

You should have received a copy of the GNU Library General Public License along with this library; see the file COPYING.LIB. If not, write to the Free Software Foundation, Inc., 51 Franklin Street, Fifth Floor, Boston, MA 02110-1301, USA.

WebKit in Qt

Copyright (C) 1999 Serika Kurusugawa. All rights reserved.

Redistribution and use in source and binary forms, with or without modification, are permitted provided that the following conditions are met:

Redistributions of source code must retain the above copyright notice, this list of conditions and the following disclaimer.

Redistributions in binary form must reproduce the above copyright notice, this list of conditions and the following disclaimer in the documentation and/or other materials provided with the distribution.

THIS SOFTWARE IS PROVIDED BY THE AUTHOR AND CONTRIBUTORS "AS IS". ANY EXPRESS OR IMPLIED WARRANTIES, INCLUDING, BUT NOT LIMITED TO, THE IMPLIED WARRANTIES OF MERCHANTABILITY AND FITNESS FOR A PARTICULAR PURPOSE ARE DISCLAIMED. IN NO EVENT SHALL THE REGENTS OR CONTRIBUTORS BE LIABLE FOR ANY DIRECT, INDIRECT, INCIDENTAL, SPECIAL, EXEMPLARY, OR CONSEQUENTIAL DAMAGES (INCLUDING, BUT NOT LIMITED TO,

PROCUREMENT OF SUBSTITUTE GOODS OR SERVICES; LOSS OF USE, DATA, OR PROFITS; OR BUSINESS INTERRUPTION) HOWEVER CAUSED AND ON ANY THEORY OF LIABILITY, WHETHER IN CONTRACT, STRICT LIABILITY, OR TORT (INCLUDING NEGLIGENCE OR OTHERWISE) ARISING IN ANY WAY OUT OF THE USE OF THIS SOFTWARE, EVEN IF ADVISED OF THE POSSIBILITY OF SUCH DAMAGE.

Shift-JIS Text Codec

ISO 2022-JP (JIS) Text Codec

EUC-JP Text Codec

Copyright (C) 1999-2000 Mizi Research Inc. All rights reserved.

Redistribution and use in source and binary forms, with or without modification, are permitted provided that the following conditions are met:

Redistributions of source code must retain the above copyright notice, this list of conditions and the following disclaimer.

Redistributions in binary form must reproduce the above copyright notice, this list of conditions and the following disclaimer in the documentation and/or other materials provided with the distribution.

THIS SOFTWARE IS PROVIDED BY THE AUTHOR AND CONTRIBUTORS "AS IS" AND ANY EXPRESS OR IMPLIED WARRANTIES, INCLUDING, BUT NOT LIMITED TO, THE IMPLIED WARRANTIES OF MERCHANTABILITY AND FITNESS FOR A PARTICULAR PURPOSE ARE DISCLAIMED. IN NO EVENT SHALL THE REGENTS OR CONTRIBUTORS BE LIABLE FOR ANY DIRECT, INDIRECT, INCIDENTAL, SPECIAL, EXEMPLARY, OR CONSEQUENTIAL DAMAGES (INCLUDING, BUT NOT LIMITED TO, PROCUREMENT OF SUBSTITUTE GOODS OR SERVICES; LOSS OF USE, DATA, OR PROFITS; OR BUSINESS INTERRUPTION) HOWEVER CAUSED AND ON ANY THEORY OF LIABILITY, WHETHER IN CONTRACT, STRICT LIABILITY, OR TORT (INCLUDING NEGLIGENCE OR OTHERWISE) ARISING IN ANY WAY OUT OF THE USE OF THIS SOFTWARE, EVEN IF ADVISED OF THE POSSIBILITY OF SUCH DAMAGE.

EUC-KR Text Codec

Copyright (C) 2000 TurboLinux, Inc. Written by Justin Yu and Sean Chen.

Copyright (C) 2001, 2002 Turbolinux, Inc. Written by James Su.

Copyright (C) 2001, 2002 ThizLinux Laboratory Ltd. Written by Anthony Fok.

Redistribution and use in source and binary forms, with or without modification, are permitted provided that the following conditions are met:

Redistributions of source code must retain the above copyright notice, this list of conditions and the following disclaimer.

Redistributions in binary form must reproduce the above copyright notice, this list of conditions and the following disclaimer in the documentation and/or other materials provided with the distribution.

THIS SOFTWARE IS PROVIDED BY THE AUTHOR AND CONTRIBUTORS "AS IS" AND ANY EXPRESS OR IMPLIED WARRANTIES, INCLUDING, BUT NOT LIMITED TO, THE IMPLIED WARRANTIES OF MERCHANTABILITY AND FITNESS FOR A PARTICULAR PURPOSE ARE DISCLAIMED. IN NO EVENT SHALL THE REGENTS OR CONTRIBUTORS BE LIABLE FOR ANY DIRECT, INDIRECT, INCIDENTAL, SPECIAL, EXEMPLARY, OR CONSEQUENTIAL DAMAGES (INCLUDING, BUT NOT LIMITED TO, PROCUREMENT OF SUBSTITUTE GOODS OR SERVICES; LOSS OF USE, DATA, OR PROFITS; OR BUSINESS INTERRUPTION) HOWEVER CAUSED AND ON ANY THEORY OF LIABILITY, WHETHER IN CONTRACT, STRICT LIABILITY, OR TORT (INCLUDING NEGLIGENCE OR OTHERWISE) ARISING IN ANY WAY OUT OF THE USE OF THIS SOFTWARE, EVEN IF ADVISED OF THE POSSIBILITY OF SUCH DAMAGE.

GBK Text Codec

Copyright (C) 2000 Ming-Che Chuang

Copyright (C) 2001, 2002 James Su, Turbolinux Inc.

Copyright (C) 2002 WU Yi, HancmLinux Inc.

Copyright (C) 2001, 2002 Anthony Fok, ThizLinux Laboratory Ltd.

Redistribution and use in source and binary forms, with or without modification, are permitted provided that the following conditions are met:

Redistributions of source code must retain the above copyright notice, this list of

conditions and the following disclaimer.

Redistributions in binary form must reproduce the above copyright notice, this list of conditions and the following disclaimer in the documentation and/or other materials provided with the distribution.

THIS SOFTWARE IS PROVIDED BY THE AUTHOR AND CONTRIBUTORS "AS IS" AND ANY EXPRESS OR IMPLIED WARRANTIES, INCLUDING, BUT NOT LIMITED TO, THE IMPLIED WARRANTIES OF MERCHANTABILITY AND FITNESS FOR A PARTICULAR PURPOSE ARE DISCLAIMED. IN NO EVENT SHALL THE REGENTS OR CONTRIBUTORS BE LIABLE FOR ANY DIRECT, INDIRECT, INCIDENTAL, SPECIAL, EXEMPLARY, OR CONSEQUENTIAL DAMAGES (INCLUDING, BUT NOT LIMITED TO, PROCUREMENT OF SUBSTITUTE GOODS OR SERVICES; LOSS OF USE, DATA, OR PROFITS; OR BUSINESS INTERRUPTION) HOWEVER CAUSED AND ON ANY THEORY OF LIABILITY, WHETHER IN CONTRACT, STRICT LIABILITY, OR TORT (INCLUDING NEGLIGENCE OR OTHERWISE) ARISING IN ANY WAY OUT OF THE USE OF THIS SOFTWARE, EVEN IF ADVISED OF THE POSSIBILITY OF SUCH DAMAGE.

Big5-HKSCS Text Codec

Copyright (C) 2000 Ming-Che Chuang

Copyright (C) 2002 James Su, Turbolinux Inc.

Copyright (C) 2002 Anthony Fok, ThizLinux Laboratory Ltd.

Redistribution and use in source and binary forms, with or without modification, are permitted provided that the following conditions are met:

Redistributions of source code must retain the above copyright notice, this list of conditions and the following disclaimer.

Redistributions in binary form must reproduce the above copyright notice, this list of conditions and the following disclaimer in the documentation and/or other materials provided with the distribution.

THIS SOFTWARE IS PROVIDED BY THE AUTHOR AND CONTRIBUTORS "AS IS" AND ANY EXPRESS OR IMPLIED WARRANTIES, INCLUDING, BUT NOT LIMITED TO, THE IMPLIED WARRANTIES OF MERCHANTABILITY AND FITNESS FOR A PARTICULAR

PURPOSE ARE DISCLAIMED. IN NO EVENT SHALL THE REGENTS OR CONTRIBUTORS BE LIABLE FOR ANY DIRECT, INDIRECT, INCIDENTAL, SPECIAL, EXEMPLARY, OR CONSEQUENTIAL DAMAGES (INCLUDING, BUT NOT LIMITED TO, PROCUREMENT OF SUBSTITUTE GOODS OR SERVICES; LOSS OF USE, DATA, OR PROFITS; OR BUSINESS INTERRUPTION) HOWEVER CAUSED AND ON ANY THEORY OF LIABILITY, WHETHER IN CONTRACT, STRICT LIABILITY, OR TORT (INCLUDING NEGLIGENCE OR OTHERWISE) ARISING IN ANY WAY OUT OF THE USE OF THIS SOFTWARE, EVEN IF ADVISED OF THE POSSIBILITY OF SUCH DAMAGE.

Big5 Text Codec

Copyright (C) 2003-2004 immodule for Qt Project. All rights reserved.

This file is written to contribute to Nokia Corporation and/or its subsidiary(-ies) under their own license. You may use this file under your Qt license. Following description is copied from their original file headers. Contact immodule-qt@freedesktop.org if any conditions of this licensing are not clear to you.

QInputContextPlugin, QInputContext, QInputContextFactory

QInputContextPlugin

QInputContext

QInputContextFactory

Copyright (C) 2003-2006 Ben van Klinken and the CLucene Team Changes are Copyright (C) 2012 Nokia Corporation and/or its subsidiary(-ies).

This library is free software; you can redistribute it and/or modify it under the terms of the GNU Lesser General Public License as published by the Free Software Foundation; either version 2.1 of the License, or (at your option) any later version.

This library is distributed in the hope that it will be useful, but WITHOUT ANY WARRANTY; without even the implied warranty of MERCHANTABILITY or FITNESS FOR A PARTICULAR PURPOSE. See the GNU Lesser General Public License for more details.

You should have received a copy of the GNU Lesser General Public License along with this library; if not, write to the Free Software Foundation, Inc., 51 Franklin Street, Fifth Floor,

QtHelp Module

Copyright (C) 2004, 2005 Daniel M. Duley

Redistribution and use in source and binary forms, with or without modification, are permitted provided that the following conditions are met:

1. Redistributions of source code must retain the above copyright notice, this list of conditions and the following disclaimer.
2. Redistributions in binary form must reproduce the above copyright notice, this list of conditions and the following disclaimer in the documentation and/or other materials provided with the distribution.

THIS SOFTWARE IS PROVIDED BY THE AUTHOR "AS IS" AND ANY EXPRESS OR IMPLIED WARRANTIES, INCLUDING, BUT NOT LIMITED TO, THE IMPLIED WARRANTIES OF MERCHANTABILITY AND FITNESS FOR A PARTICULAR PURPOSE ARE DISCLAIMED. IN NO EVENT SHALL THE AUTHOR BE LIABLE FOR ANY DIRECT, INDIRECT, INCIDENTAL, SPECIAL, EXEMPLARY, OR CONSEQUENTIAL DAMAGES (INCLUDING, BUT NOT LIMITED TO, PROCUREMENT OF SUBSTITUTE GOODS OR SERVICES; LOSS OF USE, DATA, OR PROFITS; OR BUSINESS INTERRUPTION) HOWEVER CAUSED AND ON ANY THEORY OF LIABILITY, WHETHER IN CONTRACT, STRICT LIABILITY, OR TORT (INCLUDING NEGLIGENCE OR OTHERWISE) ARISING IN ANY WAY OUT OF THE USE OF THIS SOFTWARE, EVEN IF ADVISED OF THE POSSIBILITY OF SUCH DAMAGE.

QImage

Copyright (C) 2007-2008, Apple, Inc.

All rights reserved.

Redistribution and use in source and binary forms, with or without modification, are permitted provided that the following conditions are met:

Redistributions of source code must retain the above copyright notice, this list of conditions and the following disclaimer.

Redistributions in binary form must reproduce the above copyright notice, this list of conditions and the following disclaimer in the documentation and/or other materials provided with the distribution.

Neither the name of Apple, Inc. nor the names of its contributors may be used to endorse or promote products derived from this software without specific prior written permission.

THIS SOFTWARE IS PROVIDED BY THE COPYRIGHT HOLDERS AND CONTRIBUTORS "AS IS" AND ANY EXPRESS OR IMPLIED WARRANTIES, INCLUDING, BUT NOT LIMITED TO, THE IMPLIED WARRANTIES OF MERCHANTABILITY AND FITNESS FOR A PARTICULAR PURPOSE ARE DISCLAIMED. IN NO EVENT SHALL THE COPYRIGHT OWNER OR CONTRIBUTORS BE LIABLE FOR ANY DIRECT, INDIRECT, INCIDENTAL, SPECIAL, EXEMPLARY, OR CONSEQUENTIAL DAMAGES (INCLUDING, BUT NOT LIMITED TO, PROCUREMENT OF SUBSTITUTE GOODS OR SERVICES; LOSS OF USE, DATA, OR PROFITS; OR BUSINESS INTERRUPTION) HOWEVER CAUSED AND ON ANY THEORY OF LIABILITY, WHETHER IN CONTRACT, STRICT LIABILITY, OR TORT (INCLUDING NEGLIGENCE OR OTHERWISE) ARISING IN ANY WAY OUT OF THE USE OF THIS SOFTWARE, EVEN IF ADVISED OF THE POSSIBILITY OF SUCH DAMAGE.

Contributions to the Following QtGui Files: qapplication_cocoa_p.h,
qapplication_mac.mm, qdesktopwidget_mac.mm qeventdispatcher_mac.mm
qeventdispatcher_mac_p.h qmacincludes_mac.h qt_cocoa_helpers.mm
qt_cocoa_helpers_p.h qwidget_mac.mm qsystemtrayicon_mac.mm

Copyright (C) 2012 Nokia Corporation and/or its subsidiary(-ies). All rights reserved.

Contact: Nokia Corporation (qt-info@nokia.com)

You may use this file under the terms of the BSD license as follows:

"Redistribution and use in source and binary forms, with or without modification, are permitted provided that the following conditions are met:

- Redistributions of source code must retain the above copyright notice, this list of conditions and the following disclaimer.

- Redistributions in binary form must reproduce the above copyright notice, this list of conditions and the following disclaimer in the documentation and/or other materials provided with the distribution.
- Neither the name of Nokia Corporation and its Subsidiary(-ies) nor the names of its contributors may be used to endorse or promote products derived from this software without specific prior written permission.

THIS SOFTWARE IS PROVIDED BY THE COPYRIGHT HOLDERS AND CONTRIBUTORS "AS IS" AND ANY EXPRESS OR IMPLIED WARRANTIES, INCLUDING, BUT NOT LIMITED TO, THE IMPLIED WARRANTIES OF MERCHANTABILITY AND FITNESS FOR A PARTICULAR PURPOSE ARE DISCLAIMED. IN NO EVENT SHALL THE COPYRIGHT OWNER OR CONTRIBUTORS BE LIABLE FOR ANY DIRECT, INDIRECT, INCIDENTAL, SPECIAL, EXEMPLARY, OR CONSEQUENTIAL DAMAGES (INCLUDING, BUT NOT LIMITED TO, PROCUREMENT OF SUBSTITUTE GOODS OR SERVICES; LOSS OF USE, DATA, OR PROFITS; OR BUSINESS INTERRUPTION) HOWEVER CAUSED AND ON ANY THEORY OF LIABILITY, WHETHER IN CONTRACT, STRICT LIABILITY, OR TORT (INCLUDING NEGLIGENCE OR OTHERWISE) ARISING IN ANY WAY OUT OF THE USE OF THIS SOFTWARE, EVEN IF ADVISED OF THE POSSIBILITY OF SUCH DAMAGE."

QAxServer Module, QAxContainer Module

QAxServer Module

QAxContainer Module

Copyright (C) 2012 Nokia Corporation and/or its subsidiary(-ies). All rights reserved.

Contact: Nokia Corporation (qt-info@nokia.com)

You may use this file under the terms of the BSD license as follows:

"Redistribution and use in source and binary forms, with or without modification, are permitted provided that the following conditions are met:

- Redistributions of source code must retain the above copyright notice, this list of conditions and the following disclaimer.

- Redistributions in binary form must reproduce the above copyright notice, this list of conditions and the following disclaimer in the documentation and/or other materials provided with the distribution.
- Neither the name of Nokia Corporation and its Subsidiary(-ies) nor the names of its contributors may be used to endorse or promote products derived from this software without specific prior written permission.

THIS SOFTWARE IS PROVIDED BY THE COPYRIGHT HOLDERS AND CONTRIBUTORS "AS IS" AND ANY EXPRESS OR IMPLIED WARRANTIES, INCLUDING, BUT NOT LIMITED TO, THE IMPLIED WARRANTIES OF MERCHANTABILITY AND FITNESS FOR A PARTICULAR PURPOSE ARE DISCLAIMED. IN NO EVENT SHALL THE COPYRIGHT OWNER OR CONTRIBUTORS BE LIABLE FOR ANY DIRECT, INDIRECT, INCIDENTAL, SPECIAL, EXEMPLARY, OR CONSEQUENTIAL DAMAGES (INCLUDING, BUT NOT LIMITED TO, PROCUREMENT OF SUBSTITUTE GOODS OR SERVICES; LOSS OF USE, DATA, OR PROFITS; OR BUSINESS INTERRUPTION) HOWEVER CAUSED AND ON ANY THEORY OF LIABILITY, WHETHER IN CONTRACT, STRICT LIABILITY, OR TORT (INCLUDING NEGLIGENCE OR OTHERWISE) ARISING IN ANY WAY OUT OF THE USE OF THIS SOFTWARE, EVEN IF ADVISED OF THE POSSIBILITY OF SUCH DAMAGE."

The qtmain Library

Copyright (C) 2012 Nokia Corporation and/or its subsidiary(-ies). Copyright (C) 2005 Bjoern Bergstroem

Permission is hereby granted, free of charge, to any person obtaining a copy of this software and associated documentation files (the "Software"), to deal in the Software without restriction, including without limitation the rights to use, modify, market, reproduce, grant sublicenses and distribute subject to the following conditions: The above copyright notice and this permission notice shall be included in all copies or substantial portions of the Software. These files are provided AS IS with NO WARRANTY OF ANY KIND, INCLUDING THE WARRANTY OF DESIGN, MERCHANTABILITY AND FITNESS FOR A PARTICULAR PURPOSE.

Implementation of the Recursive Shadow Casting Algorithm in Qt Designer

Copyright (C) 2012 Nokia Corporation and/or its subsidiary(-ies). Copyright (C) 2005 Roberto Raggi

Permission is hereby granted, free of charge, to any person obtaining a copy of this software and associated documentation files (the "Software"), to deal in the Software without restriction, including without limitation the rights to use, modify, market, reproduce, grant sublicenses and distribute subject to the following conditions: The above copyright notice and this permission notice shall be included in all copies or substantial portions of the Software. These files are provided AS IS with NO WARRANTY OF ANY KIND, INCLUDING THE WARRANTY OF DESIGN, MERCHANTABILITY AND FITNESS FOR A PARTICULAR PURPOSE.

Contributions to the Following qt3to4 Files

Contributions to the Following qt3to4 Files: treewalker.h, treedump.cpp, treedump.h, treewalker.cpp

Copyright (C) The Internet Society (2001). All Rights Reserved.

This document and translations of it may be copied and furnished to others, and derivative works that comment on or otherwise explain it or assist in its implementation may be prepared, copied, published and distributed, in whole or in part, without restriction of any kind, provided that the above copyright notice and this paragraph are included on all such copies and derivative works. However, this document itself may not be modified in any way, such as by removing the copyright notice or references to the Internet Society or other Internet organizations, except as needed for the purpose of developing Internet standards in which case the procedures for copyrights defined in the Internet Standards process must be followed, or as required to translate it into languages other than English.

The limited permissions granted above are perpetual and will not be revoked by the Internet Society or its successors or assigns.

This document and the information contained herein is provided on an "AS IS" basis and
THE INTERNET SOCIETY AND THE INTERNET ENGINEERING TASK FORCE

DISCLAIMS ALL WARRANTIES, EXPRESS OR IMPLIED, INCLUDING BUT NOT LIMITED TO ANY WARRANTY THAT THE USE OF THE INFORMATION HEREIN WILL NOT INFRINGE ANY RIGHTS OR ANY IMPLIED WARRANTIES OF MERCHANTABILITY OR FITNESS FOR A PARTICULAR PURPOSE.

Torrent Example

Copyright (c) 1987 X Consortium

Permission is hereby granted, free of charge, to any person obtaining a copy of this software and associated documentation files (the "Software"), to deal in the Software without restriction, including without limitation the rights to use, copy, modify, merge, publish, distribute, sublicense, and/or sell copies of the Software, and to permit persons to whom the Software is furnished to do so, subject to the following conditions:

The above copyright notice and this permission notice shall be included in all copies or substantial portions of the Software.

THE SOFTWARE IS PROVIDED "AS IS", WITHOUT WARRANTY OF ANY KIND, EXPRESS OR IMPLIED, INCLUDING BUT NOT LIMITED TO THE WARRANTIES OF MERCHANTABILITY, FITNESS FOR A PARTICULAR PURPOSE AND NONINFRINGEMENT. IN NO EVENT SHALL THE X CONSORTIUM BE LIABLE FOR ANY CLAIM, DAMAGES OR OTHER LIABILITY, WHETHER IN AN ACTION OF CONTRACT, TORT OR OTHERWISE, ARISING FROM, OUT OF OR IN CONNECTION WITH THE SOFTWARE OR THE USE OR OTHER DEALINGS IN THE SOFTWARE.

Except as contained in this notice, the name of the X Consortium shall not be used in advertising or otherwise to promote the sale, use or other dealings in this Software without prior written authorization from the X Consortium.

QRegion

Copyright (c) 1989 The Regents of the University of California. All rights reserved.

Redistribution and use in source and binary forms are permitted provided that the above copyright notice and this paragraph are duplicated in all such forms and that any documentation, advertising materials, and other materials related to such distribution and

use acknowledge that the software was developed by the University of California, Berkeley. The name of the University may not be used to endorse or promote products derived from this software without specific prior written permission. THIS SOFTWARE IS PROVIDED "AS IS" AND WITHOUT ANY EXPRESS OR IMPLIED WARRANTIES, INCLUDING, WITHOUT LIMITATION, THE IMPLIED WARRANTIES OF MERCHANTABILITY AND FITNESS FOR A PARTICULAR PURPOSE.

QDate::weekNumber()

Copyright (c) 1991 by AT&T.

Permission to use, copy, modify, and distribute this software for any purpose without fee is hereby granted, provided that this entire notice is included in all copies of any software which is or includes a copy or modification of this software and in all copies of the supporting documentation for such software.

THIS SOFTWARE IS BEING PROVIDED "AS IS", WITHOUT ANY EXPRESS OR IMPLIED WARRANTY. IN PARTICULAR, NEITHER THE AUTHOR NOR AT&T MAKES ANY REPRESENTATION OR WARRANTY OF ANY KIND CONCERNING THE MERCHANTABILITY OF THIS SOFTWARE OR ITS FITNESS FOR ANY PARTICULAR PURPOSE.

This product includes software developed by the University of California, Berkeley and its contributors.

QLocale

Copyright (c) 2000 Hans Petter Bieker. All rights reserved.

Redistribution and use in source and binary forms, with or without modification, are permitted provided that the following conditions are met:

Redistributions of source code must retain the above copyright notice, this list of conditions and the following disclaimer.

Redistributions in binary form must reproduce the above copyright notice, this list of conditions and the following disclaimer in the documentation and/or other materials provided with the distribution.

THIS SOFTWARE IS PROVIDED BY THE AUTHOR AND CONTRIBUTORS "AS IS" AND ANY EXPRESS OR IMPLIED WARRANTIES, INCLUDING, BUT NOT LIMITED TO, THE IMPLIED WARRANTIES OF MERCHANTABILITY AND FITNESS FOR A PARTICULAR PURPOSE ARE DISCLAIMED. IN NO EVENT SHALL THE REGENTS OR CONTRIBUTORS BE LIABLE FOR ANY DIRECT, INDIRECT, INCIDENTAL, SPECIAL, EXEMPLARY, OR CONSEQUENTIAL DAMAGES (INCLUDING, BUT NOT LIMITED TO, PROCUREMENT OF SUBSTITUTE GOODS OR SERVICES; LOSS OF USE, DATA, OR PROFITS; OR BUSINESS INTERRUPTION) HOWEVER CAUSED AND ON ANY THEORY OF LIABILITY, WHETHER IN CONTRACT, STRICT LIABILITY, OR TORT (INCLUDING NEGLIGENCE OR OTHERWISE) ARISING IN ANY WAY OUT OF THE USE OF THIS SOFTWARE, EVEN IF ADVISED OF THE POSSIBILITY OF SUCH DAMAGE.

TSCII Text Codec

Copyright (c) 2003, 2006 Matteo Frigo Copyright (c) 2003, 2006 Massachusetts Institute of Technology

Permission is hereby granted, free of charge, to any person obtaining a copy of this software and associated documentation files (the "Software"), to deal in the Software without restriction, including without limitation the rights to use, copy, modify, merge, publish, distribute, sublicense, and/or sell copies of the Software, and to permit persons to whom the Software is furnished to do so, subject to the following conditions:

The above copyright notice and this permission notice shall be included in all copies or substantial portions of the Software.

THE SOFTWARE IS PROVIDED "AS IS", WITHOUT WARRANTY OF ANY KIND, EXPRESS OR IMPLIED, INCLUDING BUT NOT LIMITED TO THE WARRANTIES OF MERCHANTABILITY, FITNESS FOR A PARTICULAR PURPOSE AND NONINFRINGEMENT. IN NO EVENT SHALL THE AUTHORS OR COPYRIGHT HOLDERS BE LIABLE FOR ANY CLAIM, DAMAGES OR OTHER LIABILITY, WHETHER IN AN ACTION OF CONTRACT, TORT OR OTHERWISE, ARISING FROM, OUT OF OR IN CONNECTION WITH THE SOFTWARE OR THE USE OR OTHER DEALINGS IN THE SOFTWARE.

QTestLib Manual

Copyright 1996 Daniel Dardailler. Copyright 1999 Matt Koss

Permission to use, copy, modify, distribute, and sell this software for any purpose is hereby granted without fee, provided that the above copyright notice appear in all copies and that both that copyright notice and this permission notice appear in supporting documentation, and that the name of Daniel Dardailler not be used in advertising or publicity pertaining to distribution of the software without specific, written prior permission. Daniel Dardailler makes no representations about the suitability of this software for any purpose. It is provided "as is" without express or implied warranty.

Drag and Drop

Copyright 2002 USC/Information Sciences Institute

Permission to use, copy, modify, distribute, and sell this software and its documentation for any purpose is hereby granted without fee, provided that the above copyright notice appear in all copies and that both that copyright notice and this permission notice appear in supporting documentation, and that the name of Information Sciences Institute not be used in advertising or publicity pertaining to distribution of the software without specific, written prior permission. Information Sciences Institute makes no representations about the suitability of this software for any purpose. It is provided "as is" without express or implied warranty.

INFORMATION SCIENCES INSTITUTE DISCLAIMS ALL WARRANTIES WITH REGARD TO THIS SOFTWARE, INCLUDING ALL IMPLIED WARRANTIES OF MERCHANTABILITY AND FITNESS, IN NO EVENT SHALL INFORMATION SCIENCES INSTITUTE BE LIABLE FOR ANY SPECIAL, INDIRECT OR CONSEQUENTIAL DAMAGES OR ANY DAMAGES WHATSOEVER RESULTING FROM LOSS OF USE, DATA OR PROFITS, WHETHER IN AN ACTION OF CONTRACT, NEGLIGENCE OR OTHER TORTIOUS ACTION, ARISING OUT OF OR IN CONNECTION WITH THE USE OR PERFORMANCE OF THIS SOFTWARE.

QtSvg Module

This file is part of the KDE project

Copyright (C) 2004-2009 Matthias Kretz <kretz@kde.org>

Copyright (C) 2008 Ian Monroe <ian@monroe.nu>

Copyright (C) 2007-2008 Trolltech ASA

Copyright (C) 2012 Nokia Corporation and/or its subsidiary(-ies).

Contact: Nokia Corporation (qt-info@nokia.com)

This library is free software; you can redistribute it and/or modify it under the terms of the GNU Library General Public License version 2 as published by the Free Software Foundation.

This library is distributed in the hope that it will be useful, but WITHOUT ANY WARRANTY; without even the implied warranty of MERCHANTABILITY or FITNESS FOR A PARTICULAR PURPOSE. See the GNU Library General Public License for more details.

You should have received a copy of the GNU Library General Public License along with this library; see the file COPYING.LIB. If not, write to the Free Software Foundation, Inc., 51 Franklin Street, Fifth Floor, Boston, MA 02110-1301, USA.

Phonon Module

W3C© SOFTWARE NOTICE AND LICENSE

This license came from: <http://www.w3.org/Consortium/Legal/2002/copyright-software-20021231>

This work (and included software, documentation such as READMEs, or other related items) is being provided by the copyright holders under the following license. By obtaining, using and/or copying this work, you (the licensee) agree that you have read, understood, and will comply with the following terms and conditions.

Permission to copy, modify, and distribute this software and its documentation, with or without modification, for any purpose and without fee or royalty is hereby granted, provided that you include the following on ALL copies of the software and documentation or portions thereof, including modifications:

1. The full text of this NOTICE in a location viewable to users of the redistributed or

derivative work. 2. Any pre-existing intellectual property disclaimers, notices, or terms and conditions. If none exist, the W3C Software Short Notice should be included (hypertext is preferred, text is permitted) within the body of any redistributed or derivative code. 3. Notice of any changes or modifications to the files, including the date changes were made. (We recommend you provide URIs to the location from which the code is derived.)

THIS SOFTWARE AND DOCUMENTATION IS PROVIDED "AS IS," AND COPYRIGHT HOLDERS MAKE NO REPRESENTATIONS OR WARRANTIES, EXPRESS OR IMPLIED, INCLUDING BUT NOT LIMITED TO, WARRANTIES OF MERCHANTABILITY OR FITNESS FOR ANY PARTICULAR PURPOSE OR THAT THE USE OF THE SOFTWARE OR DOCUMENTATION WILL NOT INFRINGE ANY THIRD PARTY PATENTS, COPYRIGHTS, TRADEMARKS OR OTHER RIGHTS.

COPYRIGHT HOLDERS WILL NOT BE LIABLE FOR ANY DIRECT, INDIRECT, SPECIAL OR CONSEQUENTIAL DAMAGES ARISING OUT OF ANY USE OF THE SOFTWARE OR DOCUMENTATION.

The name and trademarks of copyright holders may NOT be used in advertising or publicity pertaining to the software without specific, written prior permission. Title to copyright in this software and any associated documentation will at all times remain with copyright holders.

QtXmlPatterns Module

Copyright (C) 2000-2004, International Business Machines Corporation and others. All Rights Reserved. Copyright (C) 2007 Apple Inc. All rights reserved.

Permission is hereby granted, free of charge, to any person obtaining a copy of this software and associated documentation files (the "Software"), to deal in the Software without restriction, including without limitation the rights to use, copy, modify, merge, publish, distribute, and/or sell copies of the Software, and to permit persons to whom the Software is furnished to do so, provided that the above copyright notice(s) and this permission notice appear in all copies of the Software and that both the above copyright notice(s) and this permission notice appear in supporting documentation.

THE SOFTWARE IS PROVIDED "AS IS", WITHOUT WARRANTY OF ANY KIND, EXPRESS OR IMPLIED, INCLUDING BUT NOT LIMITED TO THE WARRANTIES OF

MERCHANTABILITY, FITNESS FOR A PARTICULAR PURPOSE AND NONINFRINGEMENT OF THIRD PARTY RIGHTS. IN NO EVENT SHALL THE COPYRIGHT HOLDER OR HOLDERS INCLUDED IN THIS NOTICE BE LIABLE FOR ANY CLAIM, OR ANY SPECIAL INDIRECT OR CONSEQUENTIAL DAMAGES, OR ANY DAMAGES WHATSOEVER RESULTING FROM LOSS OF USE, DATA OR PROFITS, WHETHER IN AN ACTION OF CONTRACT, NEGLIGENCE OR OTHER TORTIOUS ACTION, ARISING OUT OF OR IN CONNECTION WITH THE USE OR PERFORMANCE OF THIS SOFTWARE.

Except as contained in this notice, the name of a copyright holder shall not be used in advertising or otherwise to promote the sale, use or other dealings in this Software without prior written authorization of the copyright holder.

Parts of WebKit used by the QtWebKit module

Copyright (c) 1998 by Bjorn Reese <breese@imada.ou.dk>

Permission to use, copy, modify, and distribute this software for any purpose with or without fee is hereby granted, provided that the above copyright notice and this permission notice appear in all copies.

THIS SOFTWARE IS PROVIDED "AS IS" AND WITHOUT ANY EXPRESS OR IMPLIED WARRANTIES, INCLUDING, WITHOUT LIMITATION, THE IMPLIED WARRANTIES OF MERCHANTABILITY AND FITNESS FOR A PARTICULAR PURPOSE. THE AUTHORS AND CONTRIBUTORS ACCEPT NO RESPONSIBILITY IN ANY CONCEIVABLE MANNER.

Parts of the QCrashHandler class

Parts of the FreeType projects have been modified and put into Qt for use in the painting subsystem. These files are `ftraster.h`, `ftraster.c`, `ftgrays.h` and `ftgrays.c`. The following modifications has been made to these files:

- Renamed `FT_` and `ft_` symbols to `QT_FT_` and `qt_ft_` to avoid name conflicts in `qrasterdefs_p.h`.

- Removed parts of code not relevant when compiled with `_STANDALONE_` defined.

- Changed behavior in `ftraster.c` to follow X polygon filling rules.

Implemented support in ftraster.c for winding / odd even polygon fill rules.

Replaced bitmap generation with span generation in ftraster.c.

Renamed ftraster.h as qblackraster_p.h.

Renamed ftraster.c as qblackraster.c.

Renamed ftgrays.h as qgrayraster_p.h.

Renamed ftgrays.c as qgrayraster.c.

See src/3rdparty/freetype/docs/FTL.txt and src/3rdparty/freetype/docs/GPL.txt for license details.

Copyright (c) 1985, 1986, 1987 X Consortium

Permission is hereby granted, free of charge, to any person obtaining a copy of this software and associated documentation files (the "Software"), to deal in the Software without restriction, including without limitation the rights to use, copy, modify, merge, publish, distribute, sublicense, and/or sell copies of the Software, and to permit persons to whom the Software is furnished to do so, subject to the following conditions:

The above copyright notice and this permission notice shall be included in all copies or substantial portions of the Software.

THE SOFTWARE IS PROVIDED "AS IS", WITHOUT WARRANTY OF ANY KIND, EXPRESS OR IMPLIED, INCLUDING BUT NOT LIMITED TO THE WARRANTIES OF MERCHANTABILITY, FITNESS FOR A PARTICULAR PURPOSE AND NONINFRINGEMENT. IN NO EVENT SHALL THE X CONSORTIUM BE LIABLE FOR ANY CLAIM, DAMAGES OR OTHER LIABILITY, WHETHER IN AN ACTION OF CONTRACT, TORT OR OTHERWISE, ARISING FROM, OUT OF OR IN CONNECTION WITH THE SOFTWARE OR THE USE OR OTHER DEALINGS IN THE SOFTWARE.

Except as contained in this notice, the name of the X Consortium shall not be used in advertising or otherwise to promote the sale, use or other dealings in this Software without prior written authorization from the X Consortium.

Parts of the Q3PolygonScanner class used in Qt for Embedded Linux

Copyright 1987 by Digital Equipment Corporation, Maynard, Massachusetts.

All Rights Reserved

Permission to use, copy, modify, and distribute this software and its documentation for any purpose and without fee is hereby granted, provided that the above copyright notice appear in all copies and that both that copyright notice and this permission notice appear in supporting documentation, and that the name of Digital not be used in advertising or publicity pertaining to distribution of the software without specific, written prior permission.

DIGITAL DISCLAIMS ALL WARRANTIES WITH REGARD TO THIS SOFTWARE, INCLUDING ALL IMPLIED WARRANTIES OF MERCHANTABILITY AND FITNESS, IN NO EVENT SHALL DIGITAL BE LIABLE FOR ANY SPECIAL, INDIRECT OR CONSEQUENTIAL DAMAGES OR ANY DAMAGES WHATSOEVER RESULTING FROM LOSS OF USE, DATA OR PROFITS, WHETHER IN AN ACTION OF CONTRACT, NEGLIGENCE OR OTHER TORTIOUS ACTION, ARISING OUT OF OR IN CONNECTION WITH THE USE OR PERFORMANCE OF THIS SOFTWARE.

Parts of the Q3PolygonScanner class used in Qt for Embedded Linux

Copyright 1985, 1987, 1998 The Open Group

Permission to use, copy, modify, distribute, and sell this software and its documentation for any purpose is hereby granted without fee, provided that the above copyright notice appear in all copies and that both that copyright notice and this permission notice appear in supporting documentation.

The above copyright notice and this permission notice shall be included in all copies or substantial portions of the Software.

THE SOFTWARE IS PROVIDED "AS IS", WITHOUT WARRANTY OF ANY KIND, EXPRESS OR IMPLIED, INCLUDING BUT NOT LIMITED TO THE WARRANTIES OF MERCHANTABILITY, FITNESS FOR A PARTICULAR PURPOSE AND NONINFRINGEMENT. IN NO EVENT SHALL THE OPEN GROUP BE LIABLE FOR ANY CLAIM, DAMAGES OR OTHER LIABILITY, WHETHER IN AN ACTION OF CONTRACT, TORT OR OTHERWISE, ARISING FROM, OUT OF OR IN CONNECTION WITH THE SOFTWARE OR THE USE OR OTHER DEALINGS IN THE SOFTWARE.

Except as contained in this notice, the name of The Open Group shall not be used in advertising or otherwise to promote the sale, use or other dealings in this Software without prior written authorization from The Open Group.

Parts of the internal QKeyMapper class on X11 platforms

pnmscale.c - read a portable anymap and scale it

Copyright (C) 1989, 1991 by Jef Poskanzer.

Permission to use, copy, modify, and distribute this software and its documentation for any purpose and without fee is hereby granted, provided that the above copyright notice appear in all copies and that both that copyright notice and this permission notice appear in supporting documentation. This software is provided "as is" without express or implied warranty.

Parts of the internal QImageSmoothScaler

Parts of the internal QImageSmoothScaler::scale() function use code based on pnmscale.c by Jef Poskanzer.

jQuery JavaScript Library v1.3.2 <http://jquery.com/>

Copyright (c) 2009 John Resig Dual licensed under the MIT and GPL licenses.

<http://docs.jquery.com/License>

Sizzle CSS Selector Engine - v0.9.3 Copyright 2009, The Dojo Foundation Released under the MIT, BSD, and GPL Licenses. More information:

<http://sizzlejs.com/examples/webkit/fancybrowser/jquery.min.js>

Copyright (C) Research In Motion Limited 2009. All rights reserved.

Redistribution and use in source and binary forms, with or without modification, are permitted provided that the following conditions are met:

- Redistributions of source code must retain the above copyright notice, this list of conditions and the following disclaimer.
- Redistributions in binary form must reproduce the above copyright notice, this list of conditions and the following disclaimer in the documentation and/or other materials

provided with the distribution.

- Neither the name of Research In Motion Limited nor the names of its contributors may be used to endorse or promote products derived from this software without specific prior written permission.

THIS SOFTWARE IS PROVIDED BY Research In Motion Limited *AS IS* AND ANY EXPRESS OR IMPLIED WARRANTIES, INCLUDING, BUT NOT LIMITED TO, THE IMPLIED WARRANTIES OF MERCHANTABILITY AND FITNESS FOR A PARTICULAR PURPOSE ARE DISCLAIMED. IN NO EVENT SHALL Research In Motion Limited BE LIABLE FOR ANY DIRECT, INDIRECT, INCIDENTAL, SPECIAL, EXEMPLARY, OR CONSEQUENTIAL DAMAGES (INCLUDING, BUT NOT LIMITED TO, PROCUREMENT OF SUBSTITUTE GOODS OR SERVICES; LOSS OF USE, DATA, OR PROFITS; OR BUSINESS INTERRUPTION) HOWEVER CAUSED AND ON ANY THEORY OF LIABILITY, WHETHER IN CONTRACT, STRICT LIABILITY, OR TORT (INCLUDING NEGLIGENCE OR OTHERWISE) ARISING IN ANY WAY OUT OF THE USE OF THIS SOFTWARE, EVEN IF ADVISED OF THE POSSIBILITY OF SUCH DAMAGE.

`src/corelib/io/qurl.cpp`

Copyright (c) 2007-2008, Apple, Inc.

Copyright (C) 2008 Cameron Zwarich <cwzwarich@uwaterloo.ca>

Copyright (C) 2009 Google Inc. All rights reserved.

Copyright (C) 2008, 2009 Paul Pedriana <ppedriana@ea.com>. All rights reserved.

Copyright (C) 2007 Justin Haygood (jhaygood@reaktix.com)

Copyright (C) 2009 Jian Li <jianli@chromium.org>

Copyright (C) 2007 Staikos Computing Services Inc.

Copyright (C) 2008 Nokia Corporation and/or its subsidiary(-ies)

Copyright (C) 2008 Nuant Ltd.

Copyright (C) 2007 David Smith (catfish.man@gmail.com)

Copyright (C) 2008 Tony Chang <idealisms@gmail.com>

Copyright (C) 2007 Graham Dennis (graham.dennis@gmail.com)

All rights reserved.

Redistribution and use in source and binary forms, with or without modification, are permitted provided that the following conditions are met:

- Redistributions of source code must retain the above copyright notice, this list of conditions and the following disclaimer.
- Redistributions in binary form must reproduce the above copyright notice, this list of conditions and the following disclaimer in the documentation and/or other materials provided with the distribution.
- Neither the name of Apple, Inc. nor the names of its contributors may be used to endorse or promote products derived from this software without specific prior written permission.

THIS SOFTWARE IS PROVIDED BY THE COPYRIGHT HOLDERS AND CONTRIBUTORS "AS IS" AND ANY EXPRESS OR IMPLIED WARRANTIES, INCLUDING, BUT NOT LIMITED TO, THE IMPLIED WARRANTIES OF MERCHANTABILITY AND FITNESS FOR A PARTICULAR PURPOSE ARE DISCLAIMED. IN NO EVENT SHALL THE COPYRIGHT OWNER OR CONTRIBUTORS BE LIABLE FOR ANY DIRECT, INDIRECT, INCIDENTAL, SPECIAL, EXEMPLARY, OR CONSEQUENTIAL DAMAGES (INCLUDING, BUT NOT LIMITED TO, PROCUREMENT OF SUBSTITUTE GOODS OR SERVICES; LOSS OF USE, DATA, OR PROFITS; OR BUSINESS INTERRUPTION) HOWEVER CAUSED AND ON ANY THEORY OF LIABILITY, WHETHER IN CONTRACT, STRICT LIABILITY, OR TORT (INCLUDING NEGLIGENCE OR OTHERWISE) ARISING IN ANY WAY OUT OF THE USE OF THIS SOFTWARE, EVEN IF ADVISED OF THE POSSIBILITY OF SUCH DAMAGE.

Parts of WebKit used by the QtWebKit module

Copyright (C) 1999 Serika Kurusugawa, All rights reserved.

Copyright (C) 1999-2000 Mizi Research Inc. All rights reserved.

Copyright (C) 2004, 2005 Daniel M. Duley

Copyright (C) 2000 Ming-Che Chuang

Copyright (C) 2001, 2002 James Su, Turbolinux Inc.

Copyright (C) 2002 WU Yi, HancornLinux Inc.

Copyright (C) 2001, 2002 Anthony Fok, ThizLinux Laboratory Ltd.

Copyright (c) 2000 Hans Petter Bieker. All rights reserved.

Copyright (C) 2001, 2002 ThizLinux Laboratory Ltd.

Copyright (C) 2001, 2002 Turbolinux, Inc.

Redistribution and use in source and binary forms, with or without modification, are permitted provided that the following conditions are met:

1. Redistributions of source code must retain the above copyright notice, this list of conditions and the following disclaimer. 2. Redistributions in binary form must reproduce the above copyright notice, this list of conditions and the following disclaimer in the documentation and/or other materials provided with the distribution.

THIS SOFTWARE IS PROVIDED BY THE AUTHOR AND CONTRIBUTORS "AS IS" AND ANY EXPRESS OR IMPLIED WARRANTIES, INCLUDING, BUT NOT LIMITED TO, THE IMPLIED WARRANTIES OF MERCHANTABILITY AND FITNESS FOR A PARTICULAR PURPOSE ARE DISCLAIMED. IN NO EVENT SHALL THE REGENTS OR CONTRIBUTORS BE LIABLE FOR ANY DIRECT, INDIRECT, INCIDENTAL, SPECIAL, EXEMPLARY, OR CONSEQUENTIAL DAMAGES (INCLUDING, BUT NOT LIMITED TO, PROCUREMENT OF SUBSTITUTE GOODS OR SERVICES; LOSS OF USE, DATA, OR PROFITS; OR BUSINESS INTERRUPTION) HOWEVER CAUSED AND ON ANY THEORY OF LIABILITY, WHETHER IN CONTRACT, STRICT LIABILITY, OR TORT (INCLUDING NEGLIGENCE OR OTHERWISE) ARISING IN ANY WAY OUT OF THE USE OF THIS SOFTWARE, EVEN IF ADVISED OF THE POSSIBILITY OF SUCH DAMAGE.

Parts of the codecs implemented by Qt

Copyright (c) 1992, 1993 The Regents of the University of California. All rights reserved.

Redistribution and use in source and binary forms, with or without modification, are permitted provided that the following conditions are met:

1. Redistributions of source code must retain the above copyright notice, this list of conditions and the following disclaimer. 2. Redistributions in binary form must reproduce the

above copyright notice, this list of conditions and the following disclaimer in the documentation and/or other materials provided with the distribution. 3. All advertising materials mentioning features or use of this software must display the following acknowledgment: This product includes software developed by the University of California, Berkeley and its contributors. 4. Neither the name of the University nor the names of its contributors may be used to endorse or promote products derived from this software without specific prior written permission.

THIS SOFTWARE IS PROVIDED BY THE REGENTS AND CONTRIBUTORS "AS IS" AND ANY EXPRESS OR IMPLIED WARRANTIES, INCLUDING, BUT NOT LIMITED TO, THE IMPLIED WARRANTIES OF MERCHANTABILITY AND FITNESS FOR A PARTICULAR PURPOSE ARE DISCLAIMED. IN NO EVENT SHALL THE REGENTS OR CONTRIBUTORS BE LIABLE FOR ANY DIRECT, INDIRECT, INCIDENTAL, SPECIAL, EXEMPLARY, OR CONSEQUENTIAL DAMAGES (INCLUDING, BUT NOT LIMITED TO, PROCUREMENT OF SUBSTITUTE GOODS OR SERVICES; LOSS OF USE, DATA, OR PROFITS; OR BUSINESS INTERRUPTION) HOWEVER CAUSED AND ON ANY THEORY OF LIABILITY, WHETHER IN CONTRACT, STRICT LIABILITY, OR TORT (INCLUDING NEGLIGENCE OR OTHERWISE) ARISING IN ANY WAY OUT OF THE USE OF THIS SOFTWARE, EVEN IF ADVISED OF THE POSSIBILITY OF SUCH DAMAGE.

```
src/corelib/tools/qlocale.cpp
```

Copyright (C) 1997 - 2002, Makoto Matsumoto and Takuji Nishimura, All rights reserved.

Redistribution and use in source and binary forms, with or without modification, are permitted provided that the following conditions are met:

- Redistributions of source code must retain the above copyright notice, this list of conditions and the following disclaimer.
- Redistributions in binary form must reproduce the above copyright notice, this list of conditions and the following disclaimer in the documentation and/or other materials provided with the distribution.
- Neither the name of the author nor the names of contributors may be used to endorse or promote products derived from this software without specific prior written

permission.

THIS SOFTWARE IS PROVIDED BY THE COPYRIGHT HOLDERS AND CONTRIBUTORS "AS IS" AND ANY EXPRESS OR IMPLIED WARRANTIES, INCLUDING, BUT NOT LIMITED TO, THE IMPLIED WARRANTIES OF MERCHANTABILITY AND FITNESS FOR A PARTICULAR PURPOSE ARE DISCLAIMED. IN NO EVENT SHALL THE COPYRIGHT OWNER OR CONTRIBUTORS BE LIABLE FOR ANY DIRECT, INDIRECT, INCIDENTAL, SPECIAL, EXEMPLARY, OR CONSEQUENTIAL DAMAGES (INCLUDING, BUT NOT LIMITED TO, PROCUREMENT OF SUBSTITUTE GOODS OR SERVICES; LOSS OF USE, DATA, OR PROFITS; OR BUSINESS INTERRUPTION) HOWEVER CAUSED AND ON ANY THEORY OF LIABILITY, WHETHER IN CONTRACT, STRICT LIABILITY, OR TORT (INCLUDING NEGLIGENCE OR OTHERWISE) ARISING IN ANY WAY OUT OF THE USE OF THIS SOFTWARE, EVEN IF ADVISED OF THE POSSIBILITY OF SUCH DAMAGE.

Parts of WebKit used by the QtWebKit module

Copyright (C) 2005, 2007, 2008 by George Williams

Redistribution and use in source and binary forms, with or without modification, are permitted provided that the following conditions are met:

Redistributions of source code must retain the above copyright notice, this list of conditions and the following disclaimer.

Redistributions in binary form must reproduce the above copyright notice, this list of conditions and the following disclaimer in the documentation and/or other materials provided with the distribution.

The name of the author may not be used to endorse or promote products derived from this software without specific prior written permission.

THIS SOFTWARE IS PROVIDED BY THE AUTHOR ``AS IS AND ANY EXPRESS OR IMPLIED WARRANTIES, INCLUDING, BUT NOT LIMITED TO, THE IMPLIED WARRANTIES OF MERCHANTABILITY AND FITNESS FOR A PARTICULAR PURPOSE ARE DISCLAIMED. IN NO EVENT SHALL THE AUTHOR BE LIABLE FOR ANY DIRECT, INDIRECT, INCIDENTAL, SPECIAL, EXEMPLARY, OR CONSEQUENTIAL DAMAGES

(INCLUDING, BUT NOT LIMITED TO, PROCUREMENT OF SUBSTITUTE GOODS OR SERVICES; LOSS OF USE, DATA, OR PROFITS; OR BUSINESS INTERRUPTION) HOWEVER CAUSED AND ON ANY THEORY OF LIABILITY, WHETHER IN CONTRACT, STRICT LIABILITY, OR TORT (INCLUDING NEGLIGENCE OR OTHERWISE) ARISING IN ANY WAY OUT OF THE USE OF THIS SOFTWARE, EVEN IF ADVISED OF THE POSSIBILITY OF SUCH DAMAGE.

Parts of the FreeType library

Copyright 2001, 2002 Catharon Productions Inc.

This file is part of the Catharon Typography Project and shall only be used, modified, and distributed under the terms of the Catharon Open Source License that should come with this file under the name `CatharonLicense.txt'. By continuing to use, modify, or distribute this file you indicate that you have read the license and understand and accept it fully.

Note that this license is compatible with the FreeType license.

Included in the build system of the FreeType library

See CatharonLicense.txt for more information

Copyright (C) 2006 Apple Computer, Inc. All rights reserved.

Copyright (C) 2007 Eric Seidel <eric@webkit.org>

Copyright (C) 2008 Kelvin W Sherlock (ksherlock@gmail.com)

Copyright (C) 2008 Alp Toker <alp@atoker.com>

Copyright (C) 2009 University of Szeged

Copyright (C) 2007 Alexey Proskuryakov (ap@nypop.com)

Copyright (C) 2009 Daniel Bates (dbates@intudata.com)

Copyright (C) 2008 Nikolas Zimmermann <zimmermann@kde.org>

Copyright (C) 2006 Michael Emmel mike.emmel@gmail.com

Copyright (C) 2007 Holger Hans Peter Freyther

Copyright (C) 2008 Collabora Ltd. All rights reserved.

Copyright (C) 2006 Dirk Mueller <m Mueller@kde.org>

Copyright (C) 2006 Zack Rusin <zack@kde.org>

Copyright (C) 2006 George Staikos <staikos@kde.org>

Copyright (C) 2006 Simon Hausmann <hausmann@kde.org>

Copyright (C) 2006 Rob Buis <buis@kde.org>
Copyright (C) 2008 Julien Chaffraix <jchaffraix@webkit.org>
Copyright (C) 2007 Henry Mason (hmason@mac.com)
Copyright (C) 1999 Lars Knoll (knoll@kde.org)
Copyright (C) 1999 Antti Koivisto (koivisto@kde.org)
Copyright (c) 2009 The Android Open Source Project
Copyright (C) 2008 Dirk Schulze <krit@webkit.org>
Copyright (C) 2008 Nokia Corporation and/or its subsidiary(-ies)
Copyright (C) 2008 Matt Lilek <webkit@mattlilek.com>
Copyright (C) 2009 280 North Inc. All Rights Reserved.
Copyright (C) 2009 Joseph Pecoraro
Copyright (C) 2008 Anthony Ricaud (rik24d@gmail.com)
Copyright (C) 2006 Samuel Weinig <sam.weinig@gmail.com>
Copyright (C) 2008 Christian Dywan <christian@imendio.com>
Copyright (C) 2006 Michael Emmel mike.emmel@gmail.com
Copyright (C) 2009 Holger Hans Peter Freyther
Copyright (C) 2008 Google Inc. All rights reserved.
Copyright (C) 2006 Friedemann Kleint <fkleint@trolltech.com>
Copyright (C) 2007 Nicholas Shanks <webkit@nickshanks.com>
Copyright (C) 2008 Collin Jackson <collinj@webkit.org>
Copyright (C) 2007 Staikos Computing Services Inc. <info@staikos.net>
Copyright (C) 2008 Kevin Ollivier <kevino@theolliviers.com> All Rights Reserved.
Copyright (C) 2005 Frerich Raabe <raabe@kde.org>
Copyright (C) 2005 Maksim Orlovich <maksim@kde.org>
Copyright (C) 2005, 2006 Kimmo Kinnunen <kimmo.t.kinnunen@nokia.com>.
Copyright (C) 2007-2009 Torch Mobile, Inc.

Redistribution and use in source and binary forms, with or without modification, are permitted provided that the following conditions are met:

1. Redistributions of source code must retain the above copyright notice, this list of conditions and the following disclaimer.
2. Redistributions in binary form must reproduce the above copyright notice, this list of conditions and the following disclaimer in the documentation and/or other materials provided with the distribution.

THIS SOFTWARE IS PROVIDED BY APPLE COMPUTER, INC. "AS IS" AND ANY EXPRESS OR IMPLIED WARRANTIES, INCLUDING, BUT NOT LIMITED TO, THE IMPLIED WARRANTIES OF MERCHANTABILITY AND FITNESS FOR A PARTICULAR PURPOSE ARE DISCLAIMED. IN NO EVENT SHALL APPLE COMPUTER, INC. OR CONTRIBUTORS BE LIABLE FOR ANY DIRECT, INDIRECT, INCIDENTAL, SPECIAL, EXEMPLARY, OR CONSEQUENTIAL DAMAGES (INCLUDING, BUT NOT LIMITED TO, PROCUREMENT OF SUBSTITUTE GOODS OR SERVICES; LOSS OF USE, DATA, OR PROFITS; OR BUSINESS INTERRUPTION) HOWEVER CAUSED AND ON ANY THEORY OF LIABILITY, WHETHER IN CONTRACT, STRICT LIABILITY, OR TORT (INCLUDING NEGLIGENCE OR OTHERWISE) ARISING IN ANY WAY OUT OF THE USE OF THIS SOFTWARE, EVEN IF ADVISED OF THE POSSIBILITY OF SUCH DAMAGE.

Parts of WebKit used by the QtWebKit module

Copyright (C) 2009 University of Szeged All rights reserved.

Redistribution and use in source and binary forms, with or without modification, are permitted provided that the following conditions are met:

1. Redistributions of source code must retain the above copyright notice, this list of conditions and the following disclaimer.
2. Redistributions in binary form must reproduce the above copyright notice, this list of conditions and the following disclaimer in the documentation and/or other materials provided with the distribution.

THIS SOFTWARE IS PROVIDED BY UNIVERSITY OF SZEGED "AS IS" AND ANY EXPRESS OR IMPLIED WARRANTIES, INCLUDING, BUT NOT LIMITED TO, THE IMPLIED WARRANTIES OF MERCHANTABILITY AND FITNESS FOR A PARTICULAR PURPOSE ARE DISCLAIMED. IN NO EVENT SHALL UNIVERSITY OF SZEGED OR CONTRIBUTORS BE LIABLE FOR ANY DIRECT, INDIRECT, INCIDENTAL, SPECIAL, EXEMPLARY, OR CONSEQUENTIAL DAMAGES (INCLUDING, BUT NOT LIMITED TO, PROCUREMENT OF SUBSTITUTE GOODS OR SERVICES; LOSS OF USE, DATA, OR PROFITS; OR BUSINESS INTERRUPTION) HOWEVER CAUSED AND ON ANY THEORY OF LIABILITY, WHETHER IN CONTRACT, STRICT LIABILITY, OR TORT (INCLUDING NEGLIGENCE OR OTHERWISE) ARISING IN ANY WAY OUT OF THE USE OF THIS SOFTWARE, EVEN IF ADVISED OF THE POSSIBILITY OF SUCH DAMAGE.

Parts of WebKit used by the QtWebKit module

Copyright (C) 2002 Michael Ringgaard. All rights reserved.

Redistribution and use in source and binary forms, with or without modification, are permitted provided that the following conditions are met:

1. Redistributions of source code must retain the above copyright notice, this list of conditions and the following disclaimer.
2. Redistributions in binary form must reproduce the above copyright notice, this list of conditions and the following disclaimer in the documentation and/or other materials provided with the distribution.
3. Neither the name of the project nor the names of its contributors may be used to endorse or promote products derived from this software without specific prior written permission.

THIS SOFTWARE IS PROVIDED BY THE COPYRIGHT HOLDERS AND CONTRIBUTORS "AS IS" AND ANY EXPRESS OR IMPLIED WARRANTIES, INCLUDING, BUT NOT LIMITED TO, THE IMPLIED WARRANTIES OF MERCHANTABILITY AND FITNESS FOR A PARTICULAR PURPOSE ARE DISCLAIMED. IN NO EVENT SHALL THE COPYRIGHT OWNER OR CONTRIBUTORS BE LIABLE FOR ANY DIRECT, INDIRECT, INCIDENTAL, SPECIAL, EXEMPLARY, OR CONSEQUENTIAL DAMAGES (INCLUDING, BUT NOT LIMITED TO, PROCUREMENT OF SUBSTITUTE GOODS OR SERVICES; LOSS OF USE, DATA, OR PROFITS; OR BUSINESS INTERRUPTION) HOWEVER CAUSED AND ON ANY THEORY OF LIABILITY, WHETHER IN CONTRACT, STRICT LIABILITY, OR TORT (INCLUDING NEGLIGENCE OR OTHERWISE) ARISING IN ANY WAY OUT OF THE USE OF THIS SOFTWARE, EVEN IF ADVISED OF THE POSSIBILITY OF SUCH DAMAGE.

```
src/3rdparty/ce-compat/ce_time.c
```

Copyright (c) 1997-2005 University of Cambridge. All rights reserved.

Redistribution and use in source and binary forms, with or without modification, are permitted provided that the following conditions are met:

- Redistributions of source code must retain the above copyright notice, this list of conditions and the following disclaimer.

- Redistributions in binary form must reproduce the above copyright notice, this list of conditions and the following disclaimer in the documentation and/or other materials provided with the distribution.
- Neither the name of the University of Cambridge nor the name of Apple Inc. nor the names of their contributors may be used to endorse or promote products derived from this software without specific prior written permission.

THIS SOFTWARE IS PROVIDED BY THE COPYRIGHT HOLDERS AND CONTRIBUTORS "AS IS" AND ANY EXPRESS OR IMPLIED WARRANTIES, INCLUDING, BUT NOT LIMITED TO, THE IMPLIED WARRANTIES OF MERCHANTABILITY AND FITNESS FOR A PARTICULAR PURPOSE ARE DISCLAIMED. IN NO EVENT SHALL THE COPYRIGHT OWNER OR CONTRIBUTORS BE LIABLE FOR ANY DIRECT, INDIRECT, INCIDENTAL, SPECIAL, EXEMPLARY, OR CONSEQUENTIAL DAMAGES (INCLUDING, BUT NOT LIMITED TO, PROCUREMENT OF SUBSTITUTE GOODS OR SERVICES; LOSS OF USE, DATA, OR PROFITS; OR BUSINESS INTERRUPTION) HOWEVER CAUSED AND ON ANY THEORY OF LIABILITY, WHETHER IN CONTRACT, STRICT LIABILITY, OR TORT (INCLUDING NEGLIGENCE OR OTHERWISE) ARISING IN ANY WAY OUT OF THE USE OF THIS SOFTWARE, EVEN IF ADVISED OF THE POSSIBILITY OF SUCH DAMAGE.

Parts of WebKit used by the QtWebKit module

Originally written by Philip Hazel Copyright (c) 1997-2006 University of Cambridge
Copyright (C) 2007 Eric Seidel <eric@webkit.org> Copyright (C) 2002, 2004, 2006, 2007,
2008, 2009 Apple Inc. All rights reserved.

Redistribution and use in source and binary forms, with or without modification, are permitted provided that the following conditions are met:

- Redistributions of source code must retain the above copyright notice, this list of conditions and the following disclaimer.
- Redistributions in binary form must reproduce the above copyright notice, this list of conditions and the following disclaimer in the documentation and/or other materials

provided with the distribution.

- Neither the name of the University of Cambridge nor the names of its contributors may be used to endorse or promote products derived from this software without specific prior written permission.

THIS SOFTWARE IS PROVIDED BY THE COPYRIGHT HOLDERS AND CONTRIBUTORS "AS IS" AND ANY EXPRESS OR IMPLIED WARRANTIES, INCLUDING, BUT NOT LIMITED TO, THE IMPLIED WARRANTIES OF MERCHANTABILITY AND FITNESS FOR A PARTICULAR PURPOSE ARE DISCLAIMED. IN NO EVENT SHALL THE COPYRIGHT OWNER OR CONTRIBUTORS BE LIABLE FOR ANY DIRECT, INDIRECT, INCIDENTAL, SPECIAL, EXEMPLARY, OR CONSEQUENTIAL DAMAGES (INCLUDING, BUT NOT LIMITED TO, PROCUREMENT OF SUBSTITUTE GOODS OR SERVICES; LOSS OF USE, DATA, OR PROFITS; OR BUSINESS INTERRUPTION) HOWEVER CAUSED AND ON ANY THEORY OF LIABILITY, WHETHER IN CONTRACT, STRICT LIABILITY, OR TORT (INCLUDING NEGLIGENCE OR OTHERWISE) ARISING IN ANY WAY OUT OF THE USE OF THIS SOFTWARE, EVEN IF ADVISED OF THE POSSIBILITY OF SUCH DAMAGE.

Parts of WebKit used by the QtWebKit module

Copyright (C) 2006 Apple Computer, Inc. All rights reserved. Copyright (C) 2008 Google Inc. All rights reserved. Copyright (C) 2008 Matt Lilek <webkit@mattlilek.com>

Redistribution and use in source and binary forms, with or without modification, are permitted provided that the following conditions are met:

- Redistributions of source code must retain the above copyright notice, this list of conditions and the following disclaimer.
- Redistributions in binary form must reproduce the above copyright notice, this list of conditions and the following disclaimer in the documentation and/or other materials provided with the distribution.
- Neither the name of Google Inc. nor the names of its contributors may be used to endorse or promote products derived from this software without specific prior written

permission.

THIS SOFTWARE IS PROVIDED BY THE COPYRIGHT HOLDERS AND CONTRIBUTORS "AS IS" AND ANY EXPRESS OR IMPLIED WARRANTIES, INCLUDING, BUT NOT LIMITED TO, THE IMPLIED WARRANTIES OF MERCHANTABILITY AND FITNESS FOR A PARTICULAR PURPOSE ARE DISCLAIMED. IN NO EVENT SHALL THE COPYRIGHT OWNER OR CONTRIBUTORS BE LIABLE FOR ANY DIRECT, INDIRECT, INCIDENTAL, SPECIAL, EXEMPLARY, OR CONSEQUENTIAL DAMAGES (INCLUDING, BUT NOT LIMITED TO, PROCUREMENT OF SUBSTITUTE GOODS OR SERVICES; LOSS OF USE, DATA, OR PROFITS; OR BUSINESS INTERRUPTION) HOWEVER CAUSED AND ON ANY THEORY OF LIABILITY, WHETHER IN CONTRACT, STRICT LIABILITY, OR TORT (INCLUDING NEGLIGENCE OR OTHERWISE) ARISING IN ANY WAY OUT OF THE USE OF THIS SOFTWARE, EVEN IF ADVISED OF THE POSSIBILITY OF SUCH DAMAGE.

Parts of WebKit used by the QtWebKit module

Copyright (c) 1991-2009 Unicode, Inc. All rights reserved. Distributed under the Terms of Use in <http://www.unicode.org/copyright.html>.

Permission is hereby granted, free of charge, to any person obtaining a copy of the Unicode data files and any associated documentation (the "Data Files") or Unicode software and any associated documentation (the "Software") to deal in the Data Files or Software without restriction, including without limitation the rights to use, copy, modify, merge, publish, distribute, and/or sell copies of the Data Files or Software, and to permit persons to whom the Data Files or Software are furnished to do so, provided that (a) the above copyright notice(s) and this permission notice appear with all copies of the Data Files or Software, (b) both the above copyright notice(s) and this permission notice appear in associated documentation, and (c) there is clear notice in each modified Data File or in the Software as well as in the documentation associated with the Data File(s) or Software that the data or software has been modified.

THE DATA FILES AND SOFTWARE ARE PROVIDED "AS IS", WITHOUT WARRANTY OF ANY KIND, EXPRESS OR IMPLIED, INCLUDING BUT NOT LIMITED TO THE

WARRANTIES OF MERCHANTABILITY, FITNESS FOR A PARTICULAR PURPOSE AND NON-INFRINGEMENT OF THIRD PARTY RIGHTS. IN NO EVENT SHALL THE COPYRIGHT HOLDER OR HOLDERS INCLUDED IN THIS NOTICE BE LIABLE FOR ANY CLAIM, OR ANY SPECIAL INDIRECT OR CONSEQUENTIAL DAMAGES, OR ANY DAMAGES WHATSOEVER RESULTING FROM LOSS OF USE, DATA OR PROFITS, WHETHER IN AN ACTION OF CONTRACT, NEGLIGENCE OR OTHER TORTIOUS ACTION, ARISING OUT OF OR IN CONNECTION WITH THE USE OR PERFORMANCE OF THE DATA FILES OR SOFTWARE.

Except as contained in this notice, the name of a copyright holder shall not be used in advertising or otherwise to promote the sale, use or other dealings in these Data Files or Software without prior written authorization of the copyright holder.

Included in util/unicode/data, tests/auto/qtextboundaryfinder/data and tests/auto/qchar
Parts of the makeqpf tool

© 2012 Nokia Corporation and/or its subsidiaries. Nokia, Qt and their respective logos are trademarks of Nokia Corporation in Finland and/or other countries worldwide.

All other trademarks are property of their respective owners. [Privacy Policy](#)

Licensees holding valid Qt Commercial licenses may use this document in accordance with the Qt Commercial License Agreement provided with the Software or, alternatively, in accordance with the terms contained in a written agreement between you and Nokia.

Alternatively, this document may be used under the terms of the GNU Free Documentation License version 1.3 as published by the Free Software Foundation.

HDF5

HDF5 (Hierarchical Data Format 5) Software Library and Utilities Copyright 2006-2012 by The HDF Group.

NCSA HDF5 (Hierarchical Data Format 5) Software Library and Utilities Copyright 1998-2006 by the Board of Trustees of the University of Illinois.

All rights reserved.

Redistribution and use in source and binary forms, with or without modification, are permitted for any purpose (including commercial purposes) provided that the following conditions are met:

Redistributions of source code must retain the above copyright notice, this list of conditions, and the following disclaimer.

Redistributions in binary form must reproduce the above copyright notice, this list of conditions, and the following disclaimer in the documentation and/or materials provided with the distribution.

In addition, redistributions of modified forms of the source or binary code must carry prominent notices stating that the original code was changed and the date of the change.

All publications or advertising materials mentioning features or use of this software are asked, but not required, to acknowledge that it was developed by The HDF Group and by the National Center for Supercomputing Applications at the University of Illinois at Urbana-Champaign and credit the contributors.

Neither the name of The HDF Group, the name of the University, nor the name of any Contributor may be used to endorse or promote products derived from this software without specific prior written permission from The HDF Group, the University, or the Contributor, respectively.

DISCLAIMER: THIS SOFTWARE IS PROVIDED BY THE HDF GROUP AND THE CONTRIBUTORS "AS IS" WITH NO WARRANTY OF ANY KIND, EITHER EXPRESSED OR IMPLIED. In no event shall The HDF Group or the Contributors be liable for any damages suffered by the users arising out of the use of this software, even if advised of the possibility of such damage.

NETCDF

NETCDF

<http://www.unidata.ucar.edu/software/netcdf/copyright.html>

Copyright 1993-2012 University Corporation for Atmospheric Research/Unidata

Portions of this software were developed by the Unidata Program at the University Corporation for Atmospheric Research.

Access and use of this software shall impose the following obligations and understandings on the user. The user is granted the right, without any fee or cost, to use, copy, modify, alter, enhance and distribute this software, and any derivative works thereof, and its supporting documentation for any purpose whatsoever, provided that this entire notice appears in all copies of the software, derivative works and supporting documentation. Further, UCAR requests that the user credit UCAR/Unidata in any publications that result from the use of this software or in any product that includes this software, although this is not an obligation. The names UCAR and/or Unidata, however, may not be used in any advertising or publicity to endorse or promote any products or commercial entity unless specific written permission is obtained from UCAR/Unidata. The user also understands that UCAR/Unidata is not obligated to provide the user with any support, consulting, training or assistance of any kind with regard to the use, operation and performance of this software nor to provide the user with any updates, revisions, new versions or "bug fixes."

THIS SOFTWARE IS PROVIDED BY UCAR/UNIDATA "AS IS" AND ANY EXPRESS OR IMPLIED WARRANTIES, INCLUDING, BUT NOT LIMITED TO, THE IMPLIED WARRANTIES OF MERCHANTABILITY AND FITNESS FOR A PARTICULAR PURPOSE ARE DISCLAIMED. IN NO EVENT SHALL UCAR/UNIDATA BE LIABLE FOR ANY SPECIAL, INDIRECT OR CONSEQUENTIAL DAMAGES OR ANY DAMAGES WHATSOEVER RESULTING FROM LOSS OF USE, DATA OR PROFITS, WHETHER IN AN ACTION OF CONTRACT, NEGLIGENCE OR OTHER TORTIOUS ACTION, ARISING OUT OF OR IN CONNECTION WITH THE ACCESS, USE OR PERFORMANCE OF THIS SOFTWARE.-----

Ticpp

Ticpp

The MIT License (MIT)

Copyright (c) <year> <copyright holders>

Permission is hereby granted, free of charge, to any person obtaining a copy of this

software and associated documentation files (the "Software"), to deal in the Software without restriction, including without limitation the rights to use, copy, modify, merge, publish, distribute, sublicense, and/or sell copies of the Software, and to permit persons to whom the Software is furnished to do so, subject to the following conditions:

The above copyright notice and this permission notice shall be included in all copies or substantial portions of the Software.

THE SOFTWARE IS PROVIDED "AS IS", WITHOUT WARRANTY OF ANY KIND, EXPRESS OR IMPLIED, INCLUDING BUT NOT LIMITED TO THE WARRANTIES OF MERCHANTABILITY, FITNESS FOR A PARTICULAR PURPOSE AND NONINFRINGEMENT. IN NO EVENT SHALL THE AUTHORS OR COPYRIGHT HOLDERS BE LIABLE FOR ANY CLAIM, DAMAGES OR OTHER LIABILITY, WHETHER IN AN ACTION OF CONTRACT, TORT OR OTHERWISE, ARISING FROM, OUT OF OR IN CONNECTION WITH THE SOFTWARE OR THE USE OR OTHER DEALINGS IN THE SOFTWARE.

VTK

VTK is an open-source toolkit licensed under the BSD license.

Copyright (c) 1993-2008 Ken Martin, Will Schroeder, Bill Lorensen

All rights reserved.

Redistribution and use in source and binary forms, with or without modification, are permitted provided that the following conditions are met:

Redistributions of source code must retain the above copyright notice, this list of conditions and the following disclaimer.

Redistributions in binary form must reproduce the above copyright notice, this list of conditions and the following disclaimer in the documentation and/or other materials provided with the distribution.

Neither name of Ken Martin, Will Schroeder, or Bill Lorensen nor the names of any contributors may be used to endorse or promote products derived from this software without specific prior written permission.

THIS SOFTWARE IS PROVIDED BY THE COPYRIGHT HOLDERS AND CONTRIBUTORS AS IS AND ANY EXPRESS OR IMPLIED WARRANTIES, INCLUDING, BUT NOT LIMITED TO, THE IMPLIED WARRANTIES OF MERCHANTABILITY AND FITNESS FOR A PARTICULAR PURPOSE ARE DISCLAIMED. IN NO EVENT SHALL THE AUTHORS OR CONTRIBUTORS BE LIABLE FOR ANY DIRECT, INDIRECT, INCIDENTAL, SPECIAL, EXEMPLARY, OR CONSEQUENTIAL DAMAGES (INCLUDING, BUT NOT LIMITED TO, PROCUREMENT OF SUBSTITUTE GOODS OR SERVICES; LOSS OF USE, DATA, OR PROFITS; OR BUSINESS INTERRUPTION) HOWEVER CAUSED AND ON ANY THEORY OF LIABILITY, WHETHER IN CONTRACT, STRICT LIABILITY, OR TORT (INCLUDING NEGLIGENCE OR OTHERWISE) ARISING IN ANY WAY OUT OF THE USE OF THIS SOFTWARE, EVEN IF ADVISED OF THE POSSIBILITY OF SUCH DAMAGE.

See also

- [Downloads](#)
- [Installing and Setting up SMS](#)
- [System Requirements](#)

Bugfixes GMS

Important Note

If you download and install the latest update and your software maintenance has expired, you will not be able to run that install of GMS. You will need to install an earlier build of GMS or purchase maintenance. Please make sure your GMS maintenance license has not expired before downloading. You can determine your maintenance expiration date by selecting the [Help | Register](#) command from GMS. You can renew your maintenance by visiting [Aquaveo's web page](#) or by contacting a sales representative. Prices and other information about renewing your license are available on the [GMS Pricing Page](#). The latest update to GMS can be downloaded [here](#).

GMS 10.3 Bugfixes

GMS 10.3.4 - October 18, 2017

Borehole

- 10017 Message from borehole cross section editor

General

- 10007 Transient datasets don't keep their timestep
- 10011 Flooded cells symbol on UGrid with Color filled contours

Scatter

- 09996 Crash pasting scatter values

MODFLOW

- 10003 Fix layer errors
- 10010 Model checker with SFR and LAK
- 09934 fixed pilot point with null space Monte Carlo

SEEP2D

- 09997 Units for SEEP2D Flux BC

MODPATH

- 10012 Pathline selection

GMS 10.3.3 - September 22, 2017

Solids

- 09990 GMS crashes when changing material for a solid.

General

- 09969 Borehole tools missing
- 09966 Unable to import old MODFLOW files
- 09925 10.3 - Toolbar icons missing
- 09899 ETS file compatibility
- 09901 GMS Dev stops working when opening this project

Boreholes

- 09902 After deleting the Borehole dataset redrawing the display causes a crash

MT3DMS

- 09900 MT3D-USGS Define Species

- 09779 THKMIN Default Value

Interpolation

- 09896 Interpolate To MODFLOW Layers Is Wrong

MODFLOW

- 09931 GUI Test: MODFLOW fails Testing
- 09756 map to MODFLOW causes warning when using externally created DISU data
- 09673 Map → MODFLOW USG

MODPATH

- 09851 GUI Test: MP3DU generates an empty .gsf2 file

Grids

- 09878 GUI Test: Crash when mapping a Grid Frame to a 3D Grid
- 09823 Crash when converting a 2D Grid with all hidden cells to UGrid

GMS 10.3.2 - August 11, 2017

General

- 09832 Not all native MODFLOW files are exported for project for 10.3
- 09688 MODFLOW-USG translator crashes
- 09611 Map to CLN tree and properties dialogs not modal
- 09669 Popup reappears after the user has chosen the scatter set
- 09762 GUI Test: Native Text is not being saved when the path is too long

MODFLOW

- 09646 Tutorial Test Bug: MODFLOW-LGR Dual tutorial test giving wrong results
- 09669 Update to USGS MODFLOW
- 09770 Kriging datasets go missing

MODPATH

- 09789 Crash Opening Zone Code Array in MODPATH

GMS 10.3.1 - June 20, 2017

MODPATH

- 09674 10.2 Capture Zones → Arcs

MODFLOW

- 09438 CLN flow budget not matching OUT file

Mesh

- 09642 Add Breaklines command causes GMS to crash

GMS 10.3.0 - May 15, 2017

- [Initial Release](#)

GMS 10.2 Bugfixes

GMS 10.2.5 - June 20, 2017

Contours

- 09564 Contour Legend for USG face contours

General

- 09507 Paste data into MT3DMS/Source/Sink mixing package crashes GMS
- 09546 10.2 - Unable to Open .dat file in PHT3D Options Window
- 09627 Registering Image crashes GMS

MODFLOW

- 09652 MODFLOW Translator Crash
- 09440 Map Recharge Polygons to USG
- 09490 USG Contours and Recharge
- 09375 MODFLOW-NWT Parallel Warning
- 09486 More than 4 CLN wells causing MODFLOW to crash

GMS 10.2.4 - March 22, 2017

3D Grid

- 09373 Cell IJK Label not Anchored

Annotation

- 09518 VTK Error and Crash

General

- 09484 CLN vector crash
- 09488 MT3DMS TS column
- 09439 Pest Slave Directory

Map

- 09340 Can't pan while creating arcs

Materials

- 09442 Crash changing materials

MODFLOW

- 09483 Stream Package Mapping Incorrect
- 09473 Crash in Global Options
- 09441 GMS comments appear to cause MODFLOW crash
- 09427 USG Observation Well Display
- 09437 Flow budget reporting different values than zone budget and *.out file

GMS 10.2 Bugfixes

GMS 10.2.3 - January 9, 2017

Map

- 09340 Can't pan while creating arcs

MODFLOW

- 09235 Null Space MC with NWT Solver

SEAWAT

- 09257 SEAWAT bug with MF parameters

Grids

- 09297 2D UGrid cell center Z is -99999999 for imported vtu file
- 09282 Annotations disable 'Select with Poly'
- 09225 Computed Values Not Updating
- 09253 Dev - Display Not Updating After Converting to Point Dataset

General

- 09189 Framing of a 3D mesh is different
- 09373 Cell IJK Label not Anchored

GMS 10.2.2 - November 9, 2016

MODFLOW

- 09249 Stochastic runs with Clusters Tech. Support

Time Series

- 09225 Vector dataset not assigned reference time on creation

UGrid

- 09176 MODFLOW-USG example GNC file fails to import into GMS
- 09206 Unable to export and then import ugrid text dataset

Plots

- 09132 Mass vs time plot not working MT3D conceptual model tutorial

MT3DMS

- 09073 MT3DMS results not being completely visualized

GMS 10.2.1 - October 19, 2016

Display Options

- 09119 GMS quits when displaying labels, IDs, and scalars for a lot of scatter points

License

- 09088 Crash on exit when no license is available.

Map

- 09188 Map polygon displays incorrectly
- 09133 Reading map file compared with GMS 6.5

MODFLOW

- 09126 SAMG Iterations not showing
- 09175 Importing MODFLOW-USG sample model fails on output control file
- 09174 MODFLOW-USG import with missing geometry file should give more descriptive error
- 09156 STORAGECOEFFICIENT option is not supported

Plots

- 09155 Time series plot options not populating times

Save

- 09092 Observation Point error

Ugrid

- 09168 UGrid Refinement Elevation Gaps
- 09123 10.3 - Selecting UGrid cell by single click no longer works

GMS 10.2.0 - August 23, 2016

- [Initial Release!!](#)

GMS 10.1 Bugfixes

GMS 10.1.5 - August 9, 2016

Datasets

- 08933 Flow Budget "time steps don't match" for same file
- 08978 GMS crashed after generating ghost nodes and accessing the Data Calculator

General

- 09036 Value changes when entering a number with a comma
- 09000 Crash when selecting Grid -> 3D Dataset button in HUF package array
- 08996 Initialize Parameter Crash
- 08958 Get an Error that should be a warning.

Mesh

- 08945 Exporting mesh before project save creates bad mesh

MODFLOW

- 09030 MODFLOW Native text external arrays
- 08998 Transient Head not displaying even though there is a solution
- 08889 Model Check reporting error that should be warning

Simulation

- 09059 Deleting a SEEP2D simulation caused GMS to crash

Tutorial

- 08877 MODFLOW Error - Solution did not converge for heads
- 08872 Error REQUIRES NNODES=1 appears when running MODFLOW

GMS 10.1.4 - June 2, 2016

MODFLOW

- 08888 No Flow Vectors for a 1-Layer Model
- 08862 MNWI package bug
- 08852 Long execution time for Map Layer to MODFLOW from TIN

Grids

- 08892 Crash with grid visibility

T-PROGS

- 08894 T-PROGS crash

Contours

- 08853 Can't Open Project With Contours On

General

- 08857 Crash When Clicking Chinese Items in the Project Explorer
- 08855 Bad Dates and Times in Solution
- 08655 Edited Files Not Provoking Save Operation
- 08718 Crash when editing z value of feature point

MT3DMS

- 08688 MT3D Source/Sink Mixing package not applying dataset values to array

GMS 10.1.3 - March 03, 2016

MODFLOW

- 08676 UCN files do not read into GMS
- 08658 10.1 - More LGR Issues
- 08638 Parent to Child Grid RCH Package
- 08471 TOBS package errors
- 08523 10.1 - MODFLOW model checker for drains

MT3DMS

- 08429 10.0 - MT3DMS TOB well screen

MODPATH

- 08614 10.1 - Export Pathline Report

Zone Budget

- 08470 USG and Zone Budget

Pilot Points

- 08539 HK Pilot Points Forward Run

Rasters

- 08619 10.1 - Crash When Attempting to Convert to Trimmed Raster

General

- 08535 10.1 - Project Doesn't Open at the Same State of Where it was Saved
- 08533 10.0 - Shape to Features crash

GMS 10.1.2 - February 06, 2016

MODFLOW

- 08523 MODFLOW model checker for drains fix

MT3DMS

- 08429 MT3DMS TOB well screen Fix
- 08471 TOBS package errors Fix

USG

- 08470 USG and Zone Budget Problems

Pilot Points

- 08539 HK Pilot Points Forward Run

Rasters

- 08619 Crash When Attempting to Convert to Trimmed Raster

General

- 08535 Project Doesn't Open at the Same State of Where it was Saved
- 08533 Shape to Features crash

GMS 10.1.1 - December 08, 2015

2D Grid

- 8462 - MODFLOW HUF Data Visualization

Coverage

- 8246 - Loading Display theme with material colors Does Not Update Display of Boreholes

Datasets

- 8485 - Text in the table should not be editable.
- 8503 - GMS crashes after changing the F value for multiple cells.

General

- 8500 - Crash When Adding Column to GwConnections Table in CLN Dialog
- 8449 - Display Doesn't Update Correctly When Reading in MODPATH Solution
- 8498 - Crash When Attempting to Convert 3D Dataset to 2D Dataset in SWI2 Dialog
- 8486 - Changing stress periods in MODFLOW-LGR model changes stress periods in MODFLOW-USG models

Grids

- 8484 - Map to MODFLOW maps to all modflow models in the project

Import

- 8463 - Model checker doesn't find elevation errors in layers other than layer 1

Materials

- 8401 - MODFLOW importer fails to read sub file

Model Control

- 8428 - Help group box in general section of preferences dialog cut off

MODFLOW

- 8529 - Model Check Crash
- 8353 - GMS Maps to MODFLOW Slow and Saves Slow
- 8420 - Crash editing layer number in Chemical Reaction Package Dialog
- 8419 - Crash adding BC values
- 8412 - Crash when editing dechlorination parameters
- 8417 - GMS Transient Obs. Head data not importing
- 8354 - MODFLOW 2005 Import Error

Project Explorer

- 8298 - Converting an MNW model to MODFLOW-USG keeps MNW file in name file

Scatter Data

- 8356 - UPW Package Interpolation Options

GMS 10.1.0 - October 21, 2015

- [Initial Release!!](#)

GMS 10.0 Bugfixes

GMS 10.0.14 - March 04, 2016

- Updated Security and Hash for Installer

GMS 10.0.13 - December 08, 2015

MODFLOW

- 08529 - Model Check Crash
- 08484 - map to MODFLOW maps to all modflow models in the project

Project Explorer

- 08462 - MODLOW HUF Data Visualization

GMS 10.0.12 - October 21, 2015

- **3D Grid**

- 8192 - GMS slow performance switching between datasets

- **Display Options**

- 8011 - Switching to linear contour option freezes GMS

- **General**

- 8412 - Crash when editing dechlorination parameters
- 8420 - Crash editing layer number in Chemical Reaction Package Dialog

- **Grids**

- 8419 - Crash adding BC values

- **Importing**

- 8417 - GMS Transient Obs. Head data not importing
- 8136 - 10.0 - Attempting to Open Up a Second Project Doesn't Give the Option to Import Into Current Project

- **Intermediate Tests**

- 8115 - Several tests seem to call ETreeltem::GetParentItem from a NULL pointer

- **Materials**

- 8127 - Multiplier Arrays Not Working on Multiple Layers

- **Memory**

- 8212 - GMS not Releasing Temp Memory

- **MODFLOW**

- 8354 - MODFLOW 2005 Import Error
- 8303 - Crash when loading MODFLOW solution

- 8262 - Recharge and ET Don't Appear After Converting to MODFLOW-USG Simulation
- 8000 - 10.0: Confining bed saved in only layer of MODFLOW model
- 8077 - Computed Flows in Arc Groups do not update
- **MODFLOW-USG**
 - 8126 - 10.0 - LPF options not reading back in for MODFLOW-USG model
- **MT3DS**
 - 8074 - GMS Dev creates a folder without a name.
- **Raster**
 - 8112 - 10.0 - Raster interpolation issue
- **Scatter Data**
 - 8356 - UPW Package Interpolation Options
- **SRF2**
 - 8101 - SFR2 Flow Rate Width
- **Stress Periods**
 - 8169 - Adding Stress Periods creates corrupt h5 file
- **Time Steps**
 - 8189 - Calibration Targets Do Not Update On Time Series Plot
 - 8005 - 10.0 - rch time steps bug
- **UGrid**
 - 8170 - Contours Not Updating After Mapping EVT on UGrid
 - 8237 - Time Series Plots with MODFLOW-USG
- **Wells**
 - 8113 - Concentrations and Observation Well Screens

GMS 10.0.11 - August 4, 2015

- 8113 Concentrations and Observation Well Screens
- 8169 Adding Stress Periods creates corrupt h5 file
- 8136 Attempting to Open Up a Second Project Doesn't Give the Option to Import Into

Current Project

- 8127 Multiplier Arrays Not Working on Multiple Layers
- 8126 LPF options not reading back in for MODFLOW-USG model
- 8101 SFR2 Flow Rate Width
- 8112 Raster interpolation issue
- 8011 Switching to linear contour option freezes GMS

GMS 10.0.10 - June 08, 2015

- 8077 Computed Flows in Arc Groups do not update
- 8074 GMS Dev creates a folder without a name.
- 8005 10.0 - rch time steps bug
- 8000 10.0: Confining bed saved in only layer of MODFLOW model
- 8011 Switching to linear contour option freezes GMS

GMS 10.0.9 - May 13, 2015

- 8011 Switching to linear contour option freezes GMS
- 7900 10.0 - Model fails to import giving errors on flow package and MULT arrays
- 7892 Isosurface Color Ramp Contours Not Saving
- 7880 GMS unresponsive when loading in solution
- 7874 10.0 - Grid iso-surface settings dialog sometimes hangs on editing transparency
- 7860 10 - Crash importing FEFLOW fem file
- 7831 SEEP2D Tutorial coordinates
- 7829 GMS Tutorial Error: Rasters
- 7819 MODFLOW-USG model should save in native projection

- 7810 10.0 - Arc Does Not Have Name Field in Properties Dialog
- 7807 MODFLOW Layers -> 2D Scatter Points does not generate Flow Package Scatter Data for MODFLOW NWT
- 7667 Calculation Error in MT3DMS Heat Transport Tutorial
- 7775 Can't utilize parameters for stochastic unless PEST enabled
- 7759 10.0 - Raster interpolate to MODFLOW Recharge
- 7659 GMS hangs when viewing the stream flow out dataset from the CCF2 file
- 7789 Correction needed in MT3D heat transport tutorial
- 7783 Front View with Specified Dataset Crash
- 7828 UPW Package Not Converting To 2D Scatter

GMS 10.0.8 - April 28, 2015

- 7900 Model fails to import giving errors on flow package and MULT arrays
- 7892 Isosurface Color Ramp Contours Not Saving
- 7880 GMS unresponsive when loading in solution
- 7874 Grid iso-surface settings dialog sometimes hangs on editing transparency
- 7860 Crash importing FEFLOW fem file
- 7810 Arc Does Not Have Name Field in Properties Dialog
- 7829 GMS Tutorial Error: Rasters
- 7807 MODFLOW Layers -> 2D Scatter Points does not generate Flow Package Scatter Data for MODFLOW NWT
- 7819 MODFLOW-USG model should save in native projection

GMS 10.0.7 - March 15, 2015

- 7667 Calculation Error in MT3DMS Heat Transport Tutorial

- 7775 Can't utilize parameters for stochastic unless PEST enabled
- 7759 Raster interpolate to MODFLOW Recharge
- 7659 GMS hangs when viewing the stream flow out dataset from the CCF2 file
- 7789 Correction needed in MT3D heat transport tutorial
- 7783 Front View with Specified Dataset Crash

GMS 10.0.6 - January 19, 2015

- 7681 Issue with Head to HDRY in MODFLOW NWT Tutorial
- 7655 GMS gets an error message and crash after clicking OK.
- 7638 GMS2mf2k.exe is Still dependent on the Redistributable DLL's
- 7615 Observation Coverage Bug and possibly erroneous MODFLOW convergence
- 7614 PEST Not Running - Unidentified Reason
- 7601 MODFLOW|Observations|Export Trans. Obs... No Obs Head
- 7580 Raster File Vertical Units Import Wrong and crash
- 7576 Horizon Coverage to Solids Hangs GMS
- 7572 3D Scatter Scaler Value Not Displayed When Enabled

GMS 10.0.5 - November 14, 2014

- 7553 Flow budget won't open through right click
- 7523 CAD display options tied to HFB
- 7459 Streamflow Out table
- 7552 Hang on showing data calculator
- 7489 GMS crashes when trying to delete wells
- 7076 3D Scatter Data is extremely slow to work with and can't interpolate to 3D GRID

- 7341 3D Kriging Issues
- 7390 Duplicated UGrid Won't Save MODFLOW Model

GMS 10.0.4 - September 29, 2014

- 7390 Fixed Duplicated UGrid Won't Save MODFLOW Model
- 7405 Redistributing layer by more than 3 causes GMS to crash
- 7387 Pilot Point Interpolations Incorrect
- 7391 crash when attempting to convert shapefile to scatter set

GMS 10.0.3 - September 08, 2014

- 7292 Different modules labels won't change font color
- 7252 Map->MODFLOW well shift
- 5968 Export Button in edit data set values dialog doesn't work for materials
- 7387 Pilot Point Interpolations Incorrect
- 7391 Crash when attempting to convert shapefile to scatter set
- 7394 Can't open older GMS Project
- 7405 Redistributing layer by more than 3 causes GMS to crash

GMS 10.0.2 - August 20, 2014

- 7167 Crash when Tessellating Mesh
- 7276 Fixed Creation of Invalid h5 files.
- 7277 Fixed Calibration target and Residual
- 7283 Fixed Parameter Sensitivity Plot Fail
- 7301 Fixed .asc to 2D scatter not working

- 7274 Fixed MODFLOW Layers to 2D Scatter Heads
- 7224 Fixed Crash When Attempting to Select Grid Cells with Poly
- 7231 Fixed Octree Grid Builder
- 7220 Fixed Check Simulation Reporting EVT Errors
- 7198 Fixed Computed Value of Salt Observation Wells UnChanging with Transient MODFLOW and SEAWAT

Older Versions of GMS

See the article [Older Bugfixes GMS](#).

GMS 10.3 Dialog Help

This is a special page that relates GMS dialogs to wiki pages. GMS reads this page when a user hits the *Help* button in a GMS dialog, and opens the wiki at the page indicated below. Blank Dialog IDs use uniquely generated numbers because the dialog is derived or shared.

Wiki Page | [**Dialog Number** | **Dialog ID**][**QDlgClass**]

1. [SMS Package](#) | 22084 | IDD_MF_SOLVER_SMS
2. [Create Child Grid](#) | 22081 | IDD_CREATE_CHILD_GRID
3. [BFH Package](#) | 22082 | IDD_MF_BFH
4. [MODFLOW-LGR](#) | 22078 | IDD_MF_LGR_OPTIONS
5. [PHT3D](#) | 22079 | IDD_MT_PHT3D
6. [Transform](#) | 3544 | IDD_CHANGE_GEOMETRY
7. [DE4 Package](#) | 22061 | IDD_MF_SOLVER_DE4
8. [NWT Package](#) | 22060 | IDD_MF_SOLVER_NWT
9. [MODFLOW Translator](#) | 22044 | IDD_MF_TRANSLATOR
10. [Color Options](#) | 6 | IDD_COLOROPTIONS
11. [Point Display Attributes](#) | 46 | IDD_POINT_DISPLAY_ATTS
12. [New Palette](#) | 80 | IDD_NEWPALETTE
13. [PEST](#) | 285 | IDD_MF_PARAMEST_PEST
14. [MODFLOW Observations](#) | 107 | IDD_MF_OBS_DLOG
15. [HUF Package](#) | 109 | IDD_MF_HUF
16. [Borehole Editor](#) | 129 | IDD_BH_EDITOR
17. [Material Properties](#) | 22040 | IDD_MATERIALS

18. [Initialize MT3DMS Time Steps](#) | 131 | IDD_MT_INIT_TIMESTEPS
19. [GIS Tables](#) | 137 | IDD_ARCGISTABLE
20. [GIS to Feature Objects](#) | 140 | IDD_ARCGISMAPPING
21. [MODFLOW Output Control](#) | 143 | IDD_MF_OUTPUT
22. [Select Dataset](#) | 144 | IDD_SELECT_DATASET
23. [Global Options](#) | 226 | IDD_MF_GLOBALPACKAGE
24. [Stress Periods](#) | 231 | IDD_INITIALIZE_TIMES
25. [Material ID Editor](#) | 22091 | IDD_MF_SPREADSHEET_MATERIAL
26. [Material ID Editor](#) | 22090 | IDD_MF_SPREADSHEET_MATERIAL_USG
27. [MODPATH Particle Sets](#) | 268 | IDD_MP_PARTICLE_SETS
28. [Parameter Estimation Dialog](#) | 285 | IDD_MF_PARAMEST_PEST
29. [MODFLOW Sources/Sinks](#) | 943 | IDD_MF_SS_TABLE
30. [Viewing the Printed Output File](#) | 301 | IDD_CHOOSSETEXTEDITOR
31. [3D Mesh Refinement Options](#) | 391 | IDD_3DMESH_REFINEMENTOPTS
32. [Stress Periods](#) | 393 | IDD_MF_STRESS_PERIODS_NEW
33. [Conceptual Model Properties](#) | 402 | IDD_CONMOD_PROP
34. [Coverage Setup](#) | 405 | IDD_COV_SETUP
35. [Feature Objects](#) | 409 | IDD_FPROP
36. [2D Mesh Polygon Properties](#) | 454 | IDD_2DMESH_POLY_PROP
37. [Data Calculator](#) | 471 | IDD_DATA_CALCULATOR
38. [Basic Transport Package](#) | 476 | IDD_MT_BASIC_PACKAGE
39. [Copy to Clipboard](#) | 491 | IDD_COPY_SCALE
40. [Create Sphere](#) | 492 | IDD_CREATE_SPHERE
41. [Create Cylinder](#) | 493 | IDD_CREATE_CYLINDER
42. [Create Cube](#) | 494 | IDD_CREATE_CUBE

43. [Create Prism](#) | 495 | IDD_CREATE_PRISM
44. [Register Image](#) | 498 | IDD_REGIMAGE_GM2
45. [XY Series Editor](#) | 500 | IDD_XYSERIES
46. [Fix Layer Errors](#) | 504 | IDD_FIX_LAYERS
47. [Find Duplicate Nodes](#) | 508 | IDD_DUP_OPTS
48. [Calculate Mass](#) | 514 | IDD_MT_CALCMASS
49. [Gaussian Simulation Options](#) | 515 | IDD_INTERP_GAUSS
50. [FEMWATER Time Control](#) | 517 | IDD_FW_TIMECONTROL
51. [FEMWATER Run Options](#) | 518 | IDD_FW_RUNOPTIONS
52. [Display Menu](#) | 520 | IDD_EDIT_VIEW
53. [Arc -> Cross Sections](#) | QDIgPolylineToCrossSection
54. [Converting MODFLOW Layers to 2D Scatter Points](#) | 530 |
IDD_MF_LAYERS_TO_SCATTER_NEW
55. [Variable BC Options](#) | 531 | IDD_FW_VARBCOPTS
56. [NAPL Dissolution Package](#) | 533 | IDD_NAPLDISSPACKAGE
57. [SEAM3D Cometabolism Package](#) | 542 | IDD_SEAM3D_COMETPAC
58. [MODFLOW Lake Package](#) | 593 | IDD_MF_LAKEPACKAGE
59. [Display Themes](#) | 598 | IDD_DISP_TEMPLATES
60. [Sample Data -> Stratigraphy](#) | 738 | IDD_BH_SAMPLE_DATA_TO_STRAT
61. [Snap Cross Sections to TIN](#) | 740 | IDD_BHXSECT_SNAPTIN
62. [ADH Constituent Material Properties](#) | 106 |
IDD_ADH_CONSTITUENT_MATERIAL_PROPERTIES
63. [ADH Output Control](#) | 103 | IDD_ADH_OUTPUT_CONTROL
64. [ADH Analysis Options](#) | 763 | IDD_ADH_ANALYSIS_OPTS
65. [ADH Analysis Options](#) | 101 | IDD_ADH_ANALYSIS_OPTIONS

66. [Boundary Conditions](#) | 768 | IDD_ADH_BOUND_CONDS
67. [Map -> 2D Mesh](#) | 905 | IDD_SNAPMAP2DMESH
68. [Auto Select](#) | 1033 | IDD_BH_AUTO_SEL
69. [Set Operations](#) | 1041 | IDD_SET_OPERATIONS
70. [MODFLOW Multi-Node Well Package](#) | 1049 | IDD_MF_SS_MNW
71. [MODFLOW Multi-Node Well \(MNW2\) Package](#) | 22064 | IDD_MF_SS_MNW2
72. [MNW2 Wells](#) | 4498 | IDD_MF_MNW2_WELLS
73. [FEMWATER Geometry and Model Title Cards](#) | 1051 | IDD_FW_TITLES
74. [Building Solids and 3D Meshes with TINs](#) | 1052 | IDD_3D_MESH_CREATE
75. [Create Finite Difference Grid](#) | 1055 | IDD_CREATE_GRID
76. [FEMWATER Initial Conditions](#) | 1063 | IDD_FW_INITIAL_CONDITIONS
77. [FEMWATER Iteration Parameters](#) | 1078 | IDD_FW_ITER
78. [Subdivide TIN](#) | 1096 | IDD_TRI_SUBDIV
79. [Properties](#) | 1098 | IDD_ELEM_MAT
80. [SIP Package](#) | 1128 | IDD_MF_SIP_PACKAGE
81. [Text Properties](#) | 1132 | IDD_TEXT_ATTS
82. [SSOR Package](#) | 1139 | IDD_MF_SSOR_PACKAGE
83. [PCG Package](#) | 1140 | IDD_MF_PCG2_PACKAGE
84. [3D Data -> 2D Data](#) | 1146 | IDD_3DDATASET_TO_2DDATASET
85. [Converting Borehole Data To Other Data Type](#) | 1156 |
IDD_BH_SAMPLE_DATA_TO_SCATTER_PTS
86. [Interpolate Dialog](#) | 1158 | IDD_INTERP_TO_OBJ
87. [Relax Element Options](#) | 1160 | IDD_RELAX
88. [Advection Package](#) | 1172 | IDD_MT_ADVECTION
89. [Advection Package](#) | 1174 | IDD_MT_PARTS

90. [Dispersion Package](#) | 1175 | IDD_MT_DISPERSION_PACKAGE
91. [Importing Borehole Data](#) | 1186 | IDD_IMPORT_SAMPLE_DATA
92. [IFACE](#) | 1217 | IDD_MP_IFACE
93. [MODPATH ITOP](#) | 1219 | IDD_MP_ITOP
94. [General Options](#) | 1232 | IDD_MP_GENERAL_OPTIONS
95. [Find Point](#) | 1242 | IDD_SELECT_SCAT
96. [Map -> 2D Mesh](#) | 1243 | IDD_MAP_TO_2DMESH
97. [Map -> Model](#) | QDIgMapToModel
98. [Clean](#) | 1253 | IDD_CLEAN_FEATURE_OBJECTS
99. [Node BC](#) | 1256 | IDD_SEEP2DBC
00. [SEEP2D Analysis Options](#) | 1257 | IDD_SEEP2D_ANALYSIS
01. [Horizontal Flow Barriers](#) | 1269 | IDD_TOGGLE_FLOW_BARRIER
02. [Import USGS DEMs](#) | 1271 | IDD_DEM_IMPORT
03. [Interpolate to MODFLOW Layers](#) | 1277 | IDD_MAP_DATA_NEW
04. [Generate Pressure Head Initial Conditions](#) | 1334 | IDD_FW_GENERATE_IC
05. [GCG Solver](#) | 1345 | IDD_MT_GCG_SOLVER
06. [Breakline Options](#) | 1350 | IDD_BREAKLINE_OPTIONS
07. [Geometry File](#) | 1373 | IDD_FW_GEOM_FILE
08. [Jackknifing Summary](#) | 1415 | IDD_JACKKNIFE_SUMMARY
09. [Model Wrapper](#) | 1464 | IDD_MODELWRAPPEROPTS
10. [Interpolation Options](#) | 1467 | IDD_INTERP_OPTS
11. [2D IDW Interpolation Options](#) | 1468 | IDD_IDW_OPTS
12. [Subset Definition](#) | 1472 | IDD_SUBSET_PROP
13. [Natural Neighbor Options](#) | 1473 | IDD_NATNEIGH_OPTS
14. [Kriging Options](#) | 1474 | IDD_KRIG_OPTS

15. [Variogram Editor](#) | 1475 | IDD_VARIOGRAM_EDITOR
16. [Search Ellipsoid](#) | 1476 | IDD_KRIG_SEARCH_ELLIPS
17. [Experimental Variogram](#) | 1477 | IDD_VARIOGRAM_OPTS
18. [Drift Coefficients](#) | 1478 | IDD_KRIG_DRIFT
19. [Search Options](#) | 1479 | IDD_KRIG_SEARCH_OPTS
20. [MODFLOW Packages](#) | 1483 | IDD_MF_PACKAGES
21. [Redistribute Vertices](#) | 1489 | IDD_REDISTVERT
22. [van Genuchten Curve Generator](#) | 1490 | IDD_CURVE_GENERATOR
23. [Set Window Boundaries](#) | 3340 | IDD_WINDOWBOUNDS
24. [Pattern Properties](#) | 3350 | IDD_PATTERN_DISPLAY_ATTS
25. [Mesh -> 3D Tets](#) | 3352 | IDD_MESH_3DTETS
26. [Color Table](#) | 3356 | IDD_PALETTE_TABLE
27. [Reference Time](#) | 3359 | IDD_REFTIME
28. [General](#) | 1946027299 |
29. [Edit Dataset Values](#) | 3362 | IDD_EDIT_DATASET
30. [Active/Inactive Flags](#) | 3363 | IDD_ACTIVE_INACTIVE_FLAGS
31. [MODFLOW Evapotranspiration Package](#) | 1429155828 | IDD_MF_AREAL_PACK
32. [Areal Source/Sink](#) | 3365 | IDD_MT_AREALSS
33. [RT3D Chemical Reaction Package](#) | 3371 | IDD_RT_CHEMICAL_REACTION
34. [Define Species](#) | 3372 | IDD_MT_DEFINE_SPECIES
35. [Observation Points -> Scatter Points](#) | 3376 | IDD_OBS2SCATPTS
36. [Generate Particles](#) | 3377 | IDD_MP_GEN_PARTICLES
37. [TPROGS](#) | 3395 | IDD_TPROGS_MODEL
38. [Variable Time Steps](#) | 3397 | IDD_MT_VAR_TIMESTEPS
39. [MT3D/RT3D Packages](#) | 3400 | IDD_MT_PACKAGES

40. [Define Species](#) | 3401 | IDD_SEAM3D_DEFINE_SPECIES
41. [FEMWATER](#) | 3404 | IDD_FW_MODEL
42. [Redistribute Layers](#) | 3408 | IDD_3DGRD_REDISTLAYS
43. [Dataset Info](#) | 3410 | IDD_DATASET_INFO1
44. [Isosurface Volumes](#) | 3418 | IDD_ISOSURF_VOLUMES
45. [LPF Package](#) | 4102 | IDD_MF_LPF
46. [GMG Solver](#) | 4103 | IDD_MF_GMG SOLVER
47. [MODFLOW CLN Wells Package](#) | 1986454617 |
48. [MODFLOW Well Package](#) | 1249798983 |
49. [MODFLOW Drain Package](#) | 996857831 |
50. [MODFLOW Drain Return Package](#) | 4133 | IDD_MF_SS
51. [MODFLOW River Package](#) | 10943839 |
52. [MODFLOW General Head Package](#) | 1419895336 |
53. [MODFLOW Time Variant Specified Head Package](#) | 1774843214 |
54. [Initialize Stress Period](#) | 4137 | IDD_INIT_STRESSPERIOD
55. [MODFLOW Recharge Package](#) | 435688408 | IDD_MF_AREAL_PACK
56. [Source/Sink Mixing Package](#) | 4146 | IDD_MT_MIXING_PACKAGE
57. [Axis Titles](#) | 4202 | IDD_AXIS TITLES
58. [Model Wrapper](#) | 4203 | IDD_MODELWRAPPER
59. [Stochastic Options](#) | 4224 | IDD_MF_STOCHASTICOPTS
60. [Spreadsheet](#) | 4227 | IDD_MF_SPREADSHEET
61. [Spreadsheet](#) | 22087 | IDD_MF_SPREADSHEET_USG
62. [Units](#) | 4228 | IDD_UNITS
63. [Times](#) | 4230 | IDD_TIMES
64. [Solids -> HUF](#) | 4253 | IDD_SOLIDTOHUF

65. [Generate Particles at Wells](#) | 4269 | IDD_MP_GEN_PARTICLES_AT_WELLS
66. [Block Centered FLOW Package](#) | 4271 | IDD_MF_BCF
67. [Reading Stochastic Solutions](#) | 4272 | IDD_STO_READSOL
68. [Run Options](#) | 4275 | IDD_MT_RUN_OPTIONS
69. [Vector Options](#) | 4282 | IDD_VECTOR_OPTIONS
70. [Isosurfaces Options](#) | 4283 | IDD_ISO_SURFACES_OPTIONS
71. [PEST](#) | 4329 | IDD_MF_PESTMODEL
72. [Select CAD Layers](#) | 4344 | IDD_DXF_SELECT_LAYERS
73. [Dialog](#) | 4345 | IDD_MT_MODEL
74. [Seep2d](#) | 4346 | IDD_SP_MODEL
75. [Material Set Info](#) | 4350 | IDD_MATSET_INFO
76. [X-Axis Precision](#) | 4354 | IDD_HISTOGRAM_PREC
77. [Convergence Options](#) | 4363 | IDD_MF_CONVERGENCE
78. [MODFLOW - Horizontal Flow Barrier Package](#) | 4376 | IDD_HFB_PACKAGE
79. [Export Shapefile](#) | 4377 | IDD_EXPORT_SHAPEFILE
80. [Wash123D](#) | 4476 | IDD_WS_MODEL
81. [Output Control](#) | 4483 | IDD_MT_OUTPUT_CONTROL
82. [Symbol Attributes](#) | 4484 | IDD_SYMBOL_DISPLAY_ATTS
83. [Grid Frame](#) | 4488 | IDD_GRIDFRAME
84. [Modaem](#) | 4489 | IDD_AEM_MODEL
85. [GMS](#) | 4490 | IDD_SELECT_TREE
86. [GIS Conversion and Editing](#) | 4494 | IDD_DEM_SMOOTHING_OPTS
87. [FEMWATER Output Control](#) | 4499 | IDD_FW_OUTPUTCONTROL
88. [FEMWATER Particle Tracking](#) | 4501 | IDD_FW_PARTICLETRACKING
89. [Transport Observation Package](#) | 4502 | IDD_MT_TOBS

90. [MT3DMS Chemical Reaction Packages](#) | 4503 |
IDD_MT_CHEMICAL_REACTION_PKG
91. [Parameters](#) | 4507 | IDD_MF_PARAMS
92. [Display Options](#) | 4516 | IDD_DISPLAY_OPTIONS
93. [Cross Section Editor](#) | 4521 | IDD_BH_XSECT
94. [Horizons Editor](#) | 4522 | IDD_BH_HORIZONS
95. [MODFLOW Areal Package](#) | 4527 | IDD_MF_AREAL_PACK
96. [Horizon Optimizer](#) | 4532 | IDD_HOR_MODEL
97. [Flow Budget](#) | 4534 | IDD_FLOW_BUDGET
98. [File Import Filter Options](#) | 4536 | IDD_FILE_IMPORT_FILTER_OPTS
99. [Preferences](#) | 4539 | IDD_PREFS
00. [Conveyance Pipe Linkages](#) | 4561 | IDD_WASH_MAGIC_PIPE
01. [Create a Vector Dataset](#) | 4567 | IDD_SCALAR_FUNCS_TO_VEC_FUNC
02. [LINK-AMG \(LMG\) Package](#) | 4685 | IDD_MF_LMGSOLVER
03. [Model Checker](#) | 4687 | IDD_MODEL_CHECKER1
04. [Solids -> ADH](#) | 1378 | IDD_SOLIDTOADH
05. [UTEXAS](#) | 1612878051 |
06. [UTEXAS](#) | 4713 | IDD_UTX_OPTIONS (This is derived but needs to be here for testing)
07. [GeoStudio Import](#) | 1260444303 |
08. [Classify Material Zones](#) | 4564 | IDD_CLASSIFY_MATERIAL_ZONES
09. [PEST SVD](#) | 522625753 |
10. [PEST SVD-Assist](#) | 7003907 |
11. [UZF Package](#) | 963 | IDD_MF_UZF_PACKAGE
12. [SFR Package](#) | 22038 | IDD_MF_SS_SFR2

13. [SEAWAT Global Options](#) | 962 | IDD_SEAWAT_GLOBAL_OPTIONS
14. [VDF Package](#) | 22050 | IDD_SEAWAT_VDF_PACK
15. [VSC Package](#) | 22051 | IDD_SEAWAT_VSC_PACK
16. [3D Grid Cell Properties](#) | 472 | IDD_3DGRID_CELL_PROPERTIES
17. [FEMWATER Fluid Properties](#) | 22049 | IDD_PROPERTIES_FW_FLUID
18. [Creating_a_TIN](#) | 1365642895 |
19. [Creating_a_TIN](#) | 4254 | IDD_PROPERTIES (This is always derived but needs to be here for testing)
20. [T-PROGS](#) | 22053 | IDD_TPROGS_OPTIONS_BOREHOLES
21. [Confining Beds](#) | 935 | IDD_MF_LAYCBD
22. [Find Grid Cell](#) | 1195 | IDD_FIND_NODE
23. [GAGE Package](#) | 22066 | IDD_MF_GAGE_PACKAGE
24. [Lines/Arrows](#) | 3390 |
25. [Image Properties](#) | 1412192526 |
26. [CAD Properties](#) | 926064014 |
27. [SUB Package](#) | 22068 | IDD_MF_SUB_PACKAGE
28. [MODFLOW PCGN Solver](#) | 22077 | IDD_MF_SOLVER_PCGN
29. [MODFLOW Stream \(STR\) Package](#) | 4530 | IDD_MF_SS_STR
30. [Grid Orientation](#) | 1276 | IDD_GRID_ORIENT
31. [MODFLOW SUB Package Output Options](#) | 22072 | IDD_MF_SUB_OUTPUT
32. [MODFLOW Translator](#) | 936 | IDD_MF_TRANSLATE
33. [MODFLOW Name File](#) | 971 | IDD_MF_NAME_FILE
34. [MODFLOW 2000](#) | 4343 | IDD_MF_WRAPPER_MODEL
35. [Stochastic MODFLOW](#) | 4328 | IDD_MF_WRAPPER_STOMODEL
36. [Named Layer Ranges](#) | 972 | IDD_NAMED_LAYER_RANGES1

37. [Scatter -> Raster](#) | 22071 | IDD_SCATTER_TO_RASTER
38. [Scatter -> Raster](#) | 22076 | IDD_SCAT_TO_RASTER_FILES
39. [Solids -> MODFLOW](#) | 4704 | IDD_SOLIDTOMODFLOW
40. [Vertical \(Z\) Markov Chains](#) | 4101 | IDD_TPROGS_MARKOVCHAINS
41. [T-PROGS Materials](#) | 3374 | IDD_TPROGS_OPTIONS_MATERIALS
42. [XY Series Editor](#) | 22056 | IDD_XYSERIES_ADH
43. [Raster Catalog](#) | 22074 | IDD_TABLE_GMS
44. [Cross Sections](#) | 22059 | IDD_DISPOPTS_CROSS_SECTIONS1
45. [Run MODFLOW](#) | 22085 | IDD_MF_RUN_MODFLOW
46. [Current Ortho Levels](#) | 1659034061 |
47. [Select Datasets](#) | 22086 | IDD_SELECT_DATASETS
48. [Selection Info Options](#) | 195 | IDD_SELECTIONINFOPTS
49. [Horizons Wizard](#) | 4546 | IDD_HOR_INPUTS
50. [Horizons Wizard](#) | 4544 | IDD_HOR_TOPBOT_SOLID
51. [Horizons Wizard](#) | 22093 | IDD_HOR_TOPBOT_UGRID
52. [Horizons Wizard](#) | 4547 | IDD_HOR_BUILDSOLID
53. [Risk Analysis Wizard](#) | 4277 | IDD_WIZ_PPCAP2
54. [Risk Analysis Wizard](#) | 4276 | IDD_WIZ_PP1
55. [Risk Analysis Wizard](#) | 278 | IDD_WIZ_PPTHRESH2
56. [Animation Wizard](#) | 4481 | IDD_ANIM_WIZ_VIEWS
57. [Animation Wizard](#) | 4479 | IDD_ANIM_WIZ_DATA_SETS
58. [Animation Wizard](#) | 4482 | IDD_ANIM_WIZ_PARTICLES
59. [Animation Wizard](#) | 4478 | IDD_ANIM_WIZ_XSECTS
60. [Animation Wizard](#) | 4480 | IDD_ANIM_WIZ_FLOW_TRACE
61. [Animation Wizard](#) | 470 | IDD_ANIM_WIZ_OPTS

62. [Horizon Coverage](#) | 543 | IDD_BLD_HOR_COV1
63. [Horizon Coverage](#) | 4510 | IDD_BLD_HOR_COV2
64. [Horizon Coverage](#) | 4509 | IDD_BLD_HOR_COV3
65. [SEAM3D Biodegradation Package](#) | 1355 | IDD_SEAM3D_BIODEG_MIN_CONC
66. [SEAM3D Biodegradation Package](#) | 1372 | IDD_SEAM3D_BIODEG_START_CONC
67. [SEAM3D Biodegradation Package](#) | 1353 | IDD_SEAM3D_BIODEG_ELEC_ACC
68. [SEAM3D Biodegradation Package](#) | 1354 | IDD_SEAM3D_BIODEG_GEN_COEFF
69. [SEAM3D Biodegradation Package](#) | 1359 | IDD_SEAM3D_BIODEG_USE_COEFF
70. [SEAM3D Biodegradation Package](#) | 1358 | IDD_SEAM3D_BIODEG_SAT_CONST
71. [SEAM3D Biodegradation Package](#) | 1357 | IDD_SEAM3D_BIODEG_RATES
72. [Plot Wizard](#) | 3357 | IDD_PLOTWIZ1
73. [Plot Wizard](#) | 3358 | IDD_PLOTWIZ2
74. [Plot Wizard](#) | 4474 | IDD_PLOTWIZ3
75. [Plot Wizard](#) | 4553 | IDD_PLOT_FLOW
76. [Plot Wizard](#) | 4492 | IDD_PLOT_FLOWBUDGET
77. [Plot Wizard](#) | 4568 | IDD_PLOT_MASS
78. [Plot Wizard](#) | 22067 | IDD_PLOT_MF_GAGE
79. [TSIM](#) | 4562 | IDD_TPROG_TSIM_STEP1
80. [TSIM](#) | 317 | IDD_TPROG_TSIM_IN
81. [TSIM](#) | 4563 | IDD_TPROG_TSIM_EXT
82. [Map to UGrid](#) | QDIgMapToUGrid
83. [New UGrid](#) | 555948852 |
84. [CLN Process](#) | QDIgClnProcess
85. [UGrid Interpolation](#) | 22098 | IDD_INTERP_OPTS_UGRID
86. [SWI Package](#) | 22099 | IDD_MF_SPREADSHEET_SWI

87. [MODFLOW-USG Observations](#) | QDIgObsTable
88. [Run MODFLOW](#) | 22101 | IDD_RUN_MODEL
89. [Display Projection](#) | 2059088411 |
90. [Single Point Reprojection](#) | 1018566485
91. [Set Arc Directions](#) | QDIgToolSetArcDirections
92. [Mod-PATH3DU Setting Options](#) | GMS:mod-PATH3DU%20Options
93. [GMS](#) | QDIgToolInterpUGridToCoverage (Needs to be set to a real page when this dialog goes live)
94. [Linear Interpolation](#) | QDIgInInterpLinear
95. [GMS](#) | QDIgInInterpAdvanced (Needs to be set to a real page when this dialog goes live)
96. [Inverse Distance Weighted Interpolation](#) | QDIgInInterpInverse
97. [Natural Neighbor Interpolation](#) | QDIgInInterpNatural
98. [Model Executables](#) | 22058 | IDD_GENERIC_MODEL_WRAPPER
99. [Notes](#) | QDIgAllNotes
00. [Time Settings](#) | 523332814
01. [Map Shapefile to CLN](#) | QDIgMapShapefileToCln

Basic Transport Package Dialog

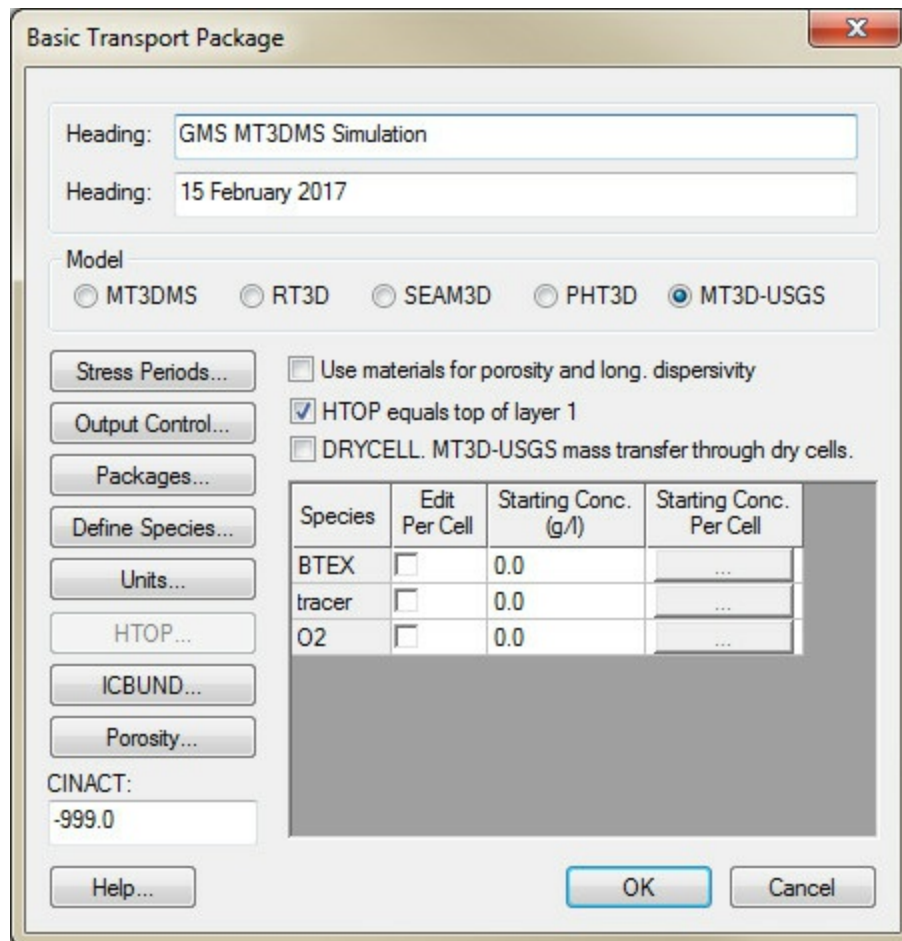

The MT3D Basic Transport Package dialog.

The first step in setting up an [MT3DMS](#) simulation is to define the data for the *Basic Transport Package*. The information defined in the *Basic Transport Package* includes the computational time intervals (stress periods), an array defining which cells are inactive and which cells have constant concentration, an array defining aquifer porosity, and array of starting concentration values. The input data for the *Basic Transport Package* must be entered before editing any of the other packages in the MT3DMS simulation. The *Basic Transport Package* dialog contains the following options:

Headings

A brief description of the model can be entered in the two lines provided at the top of the

Basic Transport Package dialog. This information is printed to the ASCII listing file output by MT3DMS.

Model Selection

The Model section in the middle of the *Basic Transport Package* dialog is used to select which transport model is to be used. The menu commands and packages and options that are available depend on which model is selected. All MT3DMS-based transport models are contained in the *MT3DMS* menu. See the [RT3D](#), [SEAM3D](#), [PHT3D](#), and [MT3D-USGS](#) pages for more information on those transport models.

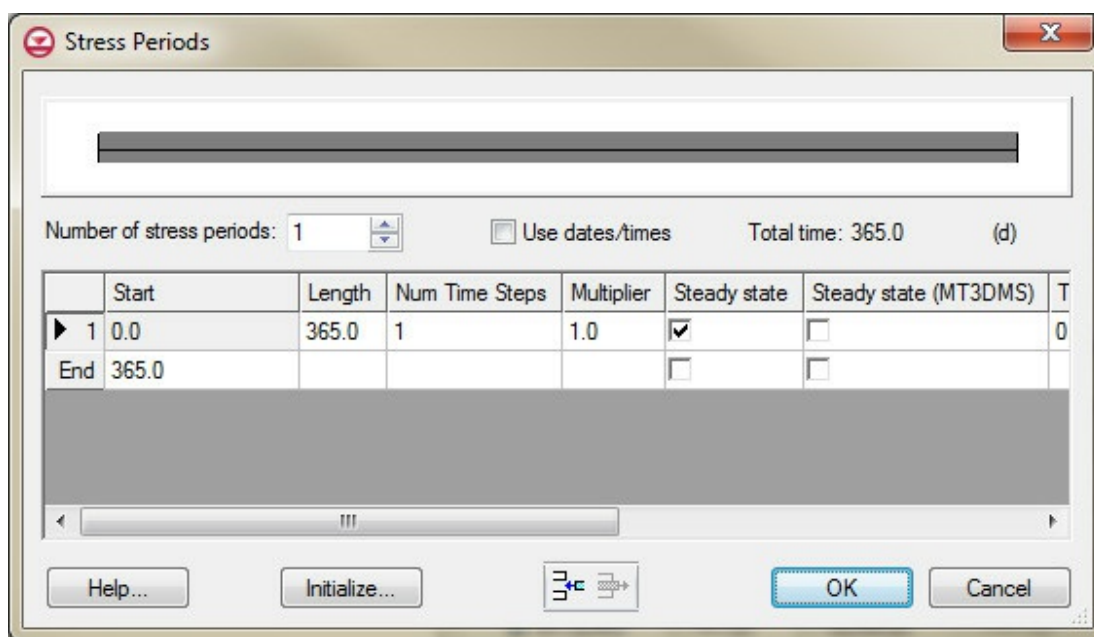

The MT3DMS Stress Periods dialog.

Stress Periods

As is the case with MODFLOW, the computational time intervals for an MT3DMS simulation are called "stress periods". Concentrations at boundary conditions or source/sink terms can only change at the beginning of each stress period. Stress periods are subdivided into time steps and time steps are subdivided into transport steps. The **Stress Periods** button on the left of the *Basic Transport Package* dialog is used to bring up the *Stress Period* dialog. If a transient MODFLOW simulation is used, the stress periods and time steps used for MT3DMS are initialized to coincide exactly with those defined for MODFLOW. If a steady

state MODFLOW simulation is used, any set of stress periods may be utilized for MT3DMS.

The *Stress Periods* dialog is identical to the [MODFLOW Stress Periods dialog](#) except for two fields. In addition to the stress period definition required by MODFLOW, MT3DMS also requires a transport step size and a maximum number of transport steps allowed for one time step. These values are defined for each stress period. If a value of zero is entered for the transport step size (the default), MT3DMS will automatically calculate an appropriate transport step size. Furthermore, if the value for the transport step size entered by the user is larger than the value computed by MT3DMS, the MT3DMS value will be used. The transport step size times the Max transport steps must be longer than the total simulation length.

Output Control

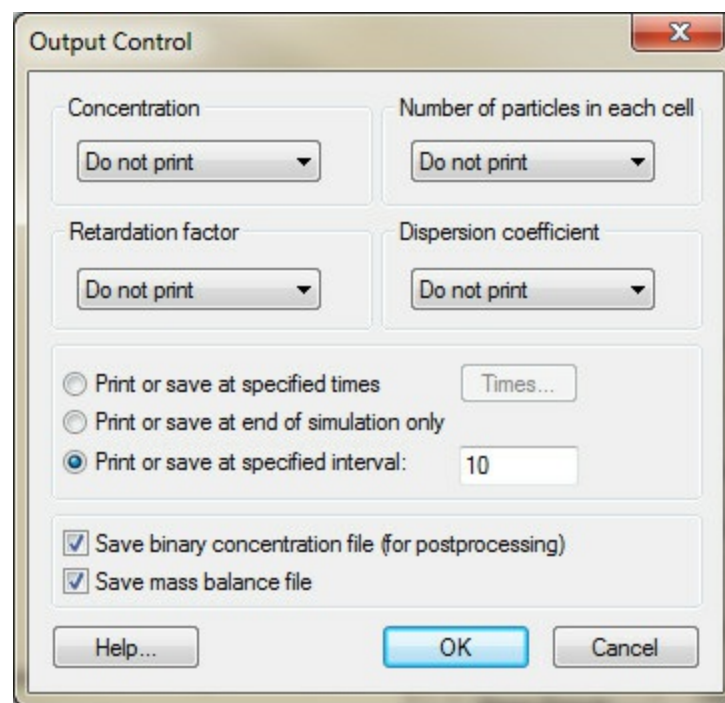

The MT3DMS Output Control dialog.

Options for printing and saving the results from an MT3DMS simulation are also included in the *Basic Transport Package*. The MT3DMS output control options are modified by selecting the **Output Control** button on the left side of the *Basic Transport Package* dialog. This brings up the *MT3D Output Control* dialog.

One of the output options is an unformatted (binary) concentration file which is used for post-processing by GMS. This option is selected using the toggle at the bottom of the dialog. With the version of MT3DMS included with GMS, the concentration file is saved directly from MT3DMS as a GMS binary scalar dataset file.

Another option is to *Print or save at specified times*. When this option is selected, the **Times** button is undimmed. Selecting the **Times** button brings up a spreadsheet that enables specifying the times that the output will be printed or saved. The spreadsheet can be quickly initialized by selecting the **Initialize Values** button at the bottom of the dialog. This button brings up the *Initialize Time Steps* dialog. This dialog is composed of edit fields that will automatically populate the times that MT3D data will be saved or printed.

Packages

The **Packages** button on the left of the *Basic Transport Package* dialog brings up the *Packages* dialog. This dialog is used to specify which of the [packages](#) are to be used in the simulation. The check box to the left of the package name is selected to signify that a package will be utilized as part of the simulation. Some of the packages are used by RT3D or SEAM3D and are dimmed for MT3DMS simulations.

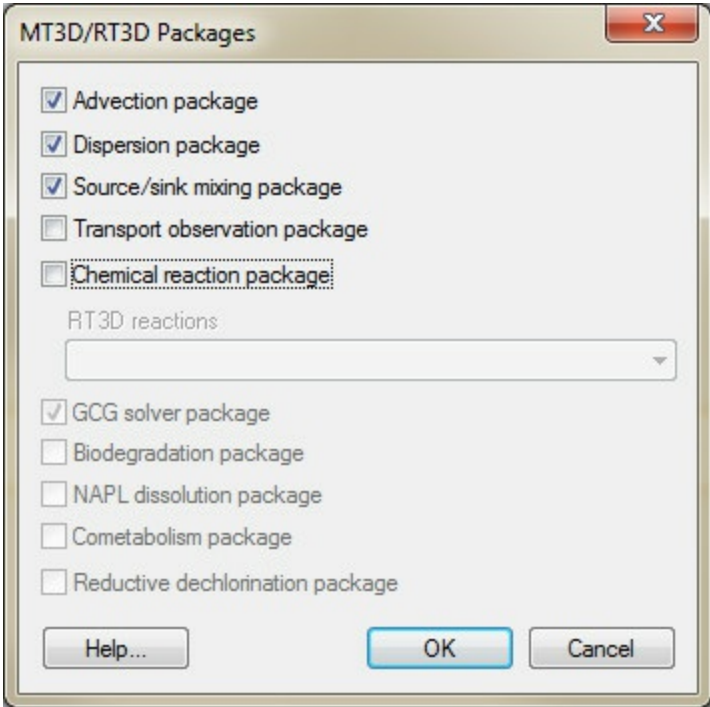

The MT3DMS/RT3D Packages dialog.

Define Species

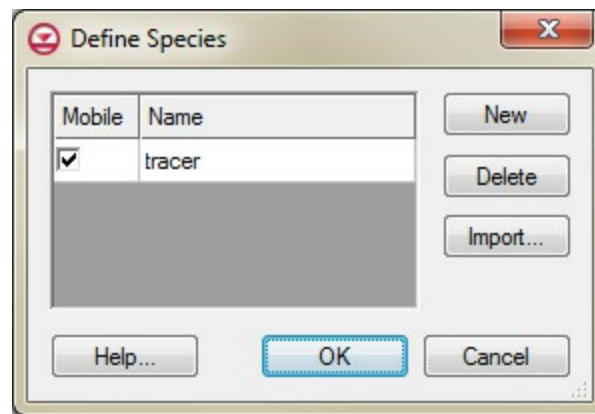

The MT3DMS Define Species dialog.

MT3DMS is a multi-species transport model. It can track the migration and concentration of several species at once. The **Define Species** button is used to define the number of species in the simulation and the name and type of each species. The button brings up the *Define Species* dialog.

The species are listed in the box on the left side of the dialog. Species are added and deleted using the **New** and **Delete** buttons. The name of a selected species can be edited. The **Mobile** toggle is used for RT3D and is dimmed for MT3DMS simulations.

The species names are not used by the MT3DMS code. They are only used in GMS to simplify the model input. In MT3DMS, all species are identified by an integer ID. The species names are saved to the MT3DMS super file (*.mts). When building a new simulation, it is sometimes useful to use the same set of names used in a previous simulation. This can be accomplished by selecting the **Import** button and selecting the MT3DMS super file used by the previous simulation. This automatically loads in the species names to the list.

Units

All MT3DMS input parameters must be entered using a consistent set of units. The **Units** button brings up a dialog which can be used to specify a standard unit for length, time, mass, force, and concentration. The selected units are used by GMS to post the appropriate unit labels next to each of the input fields in the MT3DMS interface. These

labels serve as a reminder of the correct units. The units must be consistent with the units used in the MODFLOW simulation.

CINACT

The CINACT value is written to the MT3DMS solution file wherever an inactive concentration cell exists (ICBUND=0). This value should be selected so that it will not likely be a valid concentration computed from MT3DMS. The default value of -999 is generally sufficient.

Use Materials for Porosity and Long. Dispersivity

If this option is selected, the porosities and longitudinal dispersivities specified in the *Materials* dialog will be used in the MT3DMS model.

HTOP Equals Top of Layer 1

In some cases it is useful to explicitly define the HTOP array separately from the top elevation array for layer 1 defined in the Global Options package. If the toggle entitled HTOP equals top of layer 1 is turned off, an HTOP array can be explicitly defined. This option should be used if the top of layer 1 is substantially higher than the computed water table. In such cases, using the top of layer 1 could lead to significant error (see MT3DMS Reference Manual).

Another option would be to use the default approach and lower the value of the layer 1 top elevation array. For unconfined layers, this array is not used by MODFLOW anyway. The only reason to keep the HTOP array separate from the top elevation array is for visualization. When a MODFLOW solution is displayed in side view, GMS plots the computed water table on top of the cross section display. Using the top elevation of layer 1 as the ground surface makes it possible to see exactly where the water table lies in relation to the ground surface and illustrates where cells are flooded.

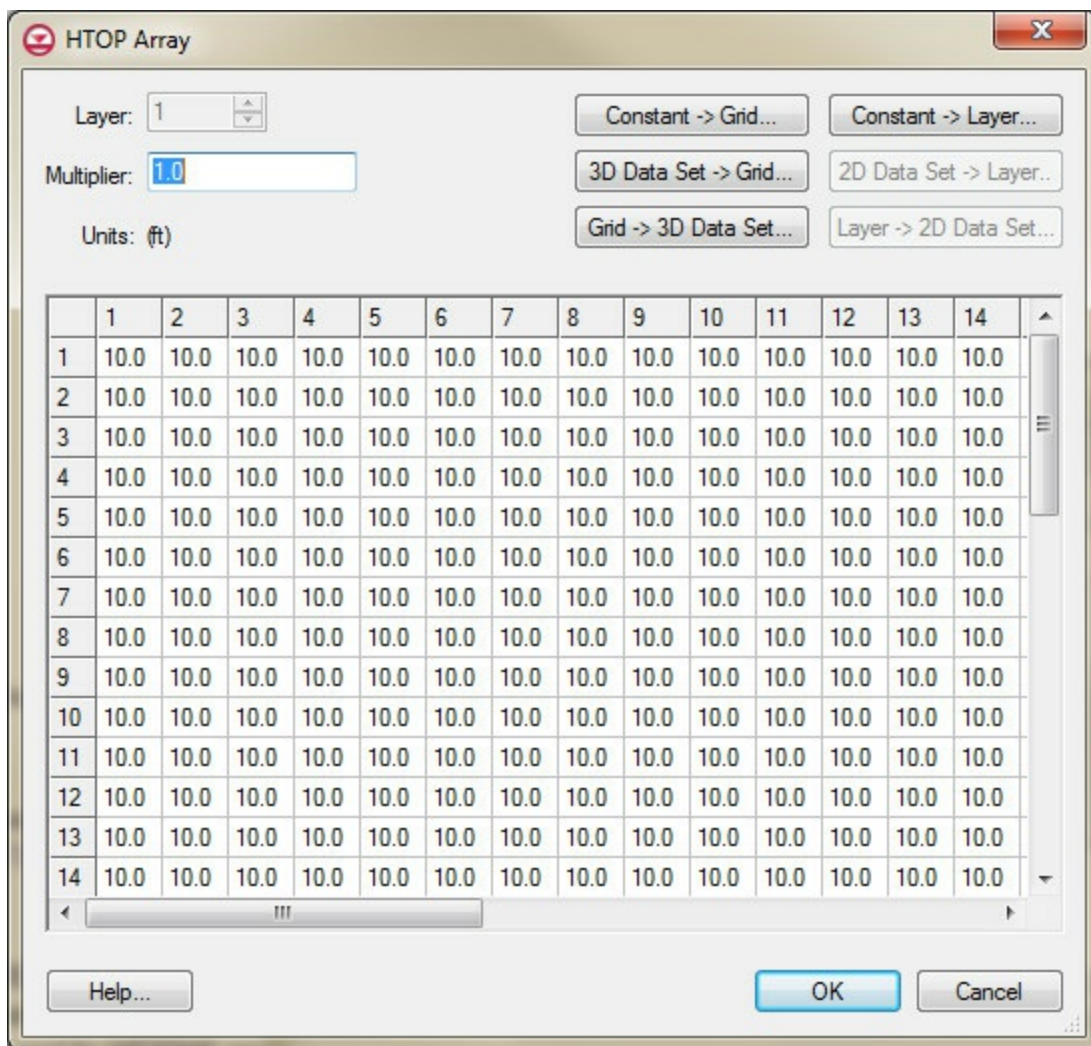

The MT3DMS HTOP Array dialog.

DRYCELL

The DRYCELL check box enables mass transfer through dry cells from [MODFLOW-NWT](#) models. This feature is available in [MT3D-USGS](#).

HTOP and Thickness Arrays

Part of the input to the Basic Transport package is a set of arrays defining the layer geometry. These arrays include an HTOP array that defines the top elevations for the top layer and a thickness array for each layer. Since MT3DMS can only be used in combination with the True Layer approach in MODFLOW, there is no need to input these arrays in the MT3DMS interface. By default, the HTOP array is assumed to be equal to the top elevation array for layer 1 defined in the Global Options package of MODFLOW. Furthermore, the thickness arrays are automatically generated by GMS using the top and bottom elevation

arrays when the Basic Transport package file is written.

Starting Concentration

The initial concentration of all species is specified using the spread sheet on the right side of the dialog. A single constant value can be entered for each species or if desired the *Edit Per Cell* option can be turned on and the starting concentration is edited for each cell by selecting the button in the *Starting Conc. Per Cell* column. Starting concentration can also be edited on a cell-by-cell basis using the **Cell Properties** command.

ICBUND

The **ICBUND** button in the *Basic Transport Package* dialog is used to enter the values of the **ICBUND** array.

Porosity

The array defining the porosity of each cell in the model can be defined and edited by selecting the **Porosity** button in the *Basic Transport Package*. This array can also be initialized using a conceptual model in the Map module. It can also be edited on a cell-by-cell basis using the **Cell Properties** command.

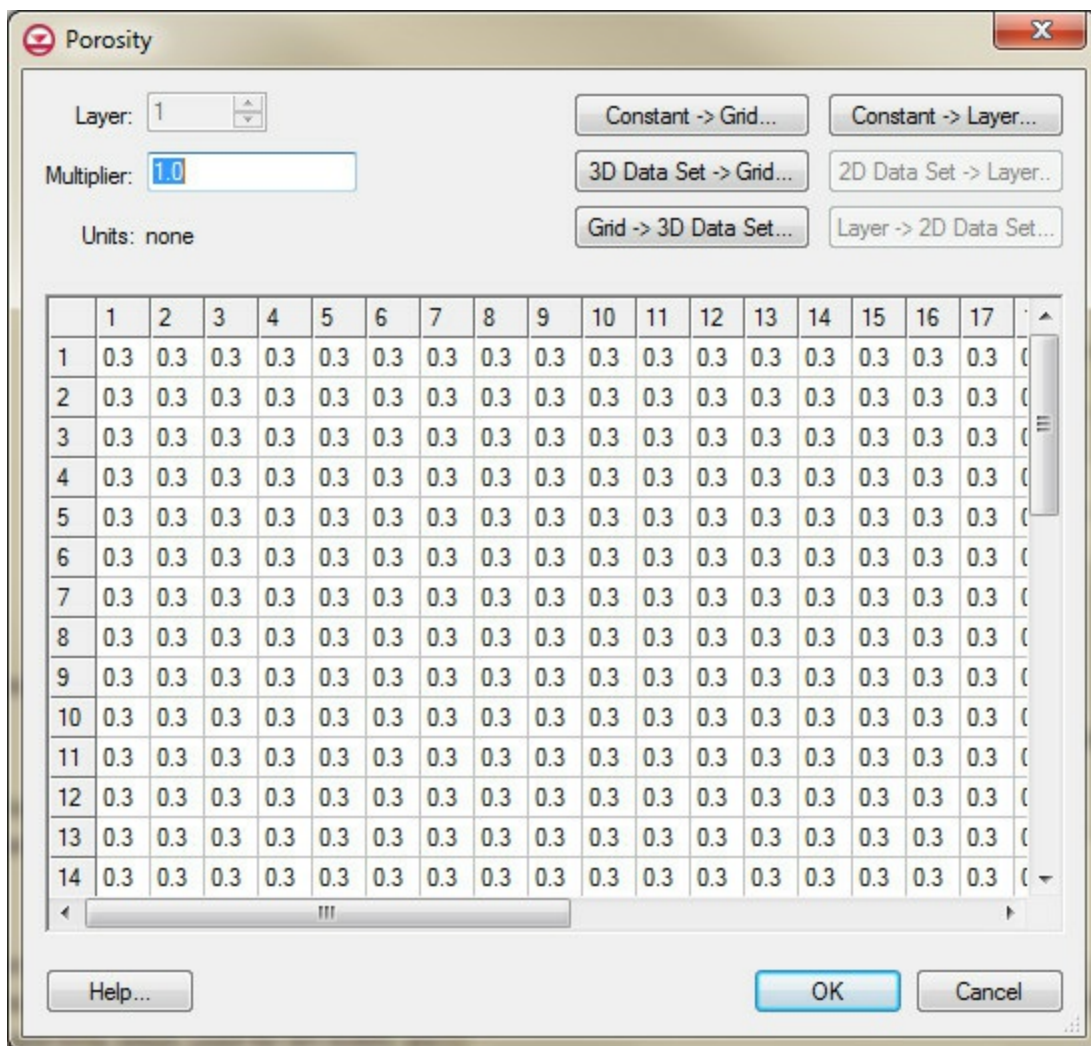

The MT3D Porosity dialog.

Cell Properties

The *Cell Properties* dialog allows the user to edit cell properties. Most cell properties are associated with a model such as MODFLOW or MT3DMS. If no models exist in the GMS project then the *Cell Properties* dialog will only allow editing of the material assigned to the grid cell.

MODFLOW

Several input arrays defining parameters such as starting head, [IBOUND](#), hydraulic conductivity, and transmissivity are defined in the [Global/Basic](#) and [BCF](#), [LPF](#), or [HUF](#) packages. These arrays can be edited in the *Basic* and *BCF/LPF/HUF Package* dialogs, or they can be initialized using a [conceptual model](#) in the [Map module](#). In many cases however, it is necessary to view or edit the values on a cell-by-cell basis. This can be accomplished using the **Cell Properties** command in the *MODFLOW* menu.

Before selecting the **Cell Properties** command, a set of cells should be selected using the cell selection tools. Once the command is selected, the [MODFLOW Cell Attributes](#) dialog appears.

The parameters for the selected cells are changed by typing in new values in the edit fields. If more than one cell is selected when the **Cell Properties** command is selected, the available edit fields will be left blank (unless all values are the same for that parameter). To edit one of the parameters, click on the desired text edit field, enter the new value and click on the **OK** button. When the **OK** button is selected, only the parameters whose edit fields that have data are changed. This makes it possible to change one of the available parameters (e.g., transmissivity) for all of the selected cells while leaving the other parameters unchanged.

NOTE: When using materials to define the MODFLOW model, the *Cell Properties* dialog will show the material properties relating to the material of the selected cell. The user will not be able to edit these values on a cell-by-cell basis, but the user can either edit the material type for this cell if the active material set is the default material set, or the user can

change the material properties for the material (which affects every cell that uses that material).

MT3DMS/RT3D/SEAM3D

MT3DMS inputs that vary on a cell by cell basis can also be editing using this dialog and editing the data in the *MT3DMS* tab.

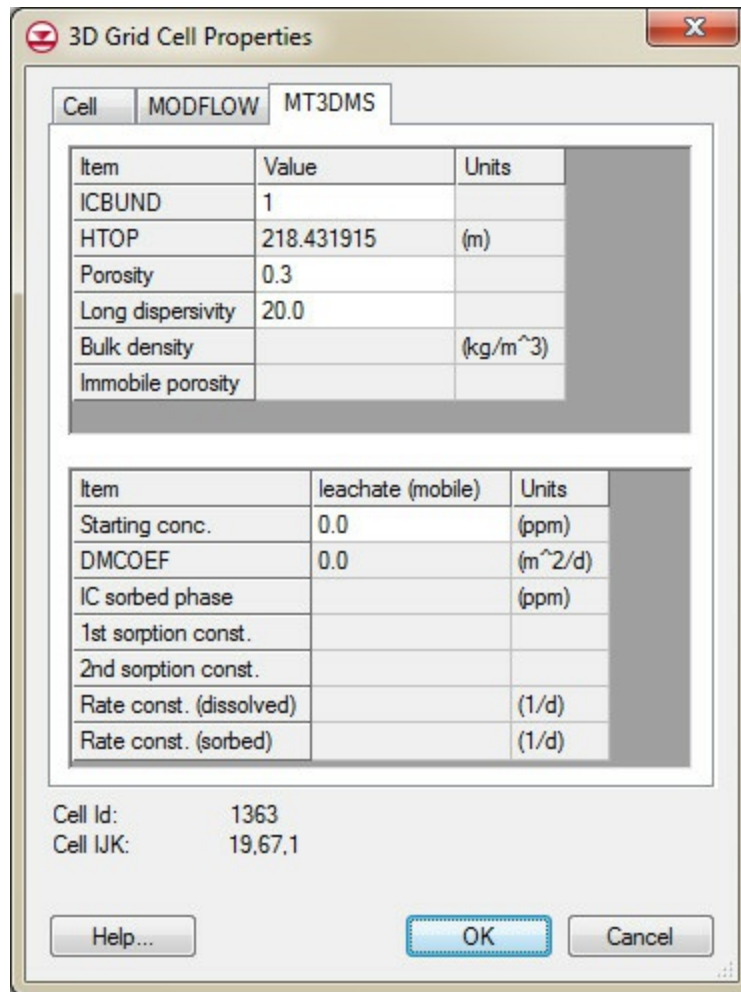

3D Grid Cell Properties dialog showing the MT3DMS tab.

Classify Material Zones

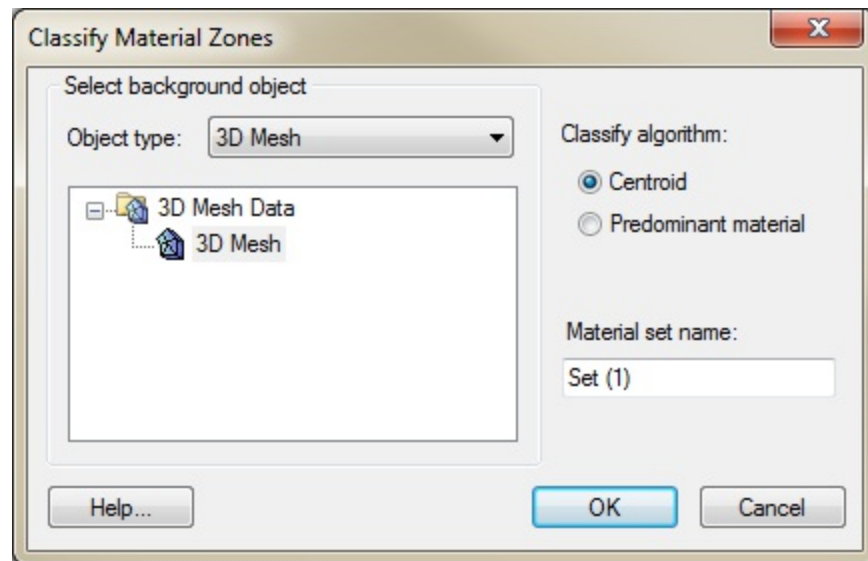

The Classify Material Zones dialog

The *Classify Material Zones* dialog allows assigning materials to a grid or mesh. The dialog is reached by right-clicking on a grid or mesh then selecting the **Classify Material Zones** command.

Select background object

The background object defines the source of the materials to be assigned to the grid or mesh. The source of the materials can be solids or a different grid or mesh.

Classify algorithm

Two options are available to assign materials to the grid or mesh: *Centroid* and *Predominant material*. When the *Centroid* method is used, the centroid of the grid cell or mesh element is calculated. Then the location of the calculated centroid is found in the background object (grid, mesh, or solid) and the material at that location in the background object is assigned to the grid cell or mesh element. If the calculated centroid is outside of

the background object then the material of the grid cell or mesh element is not changed.

When the *Predominant material* method is used to assign materials to a grid from a solid the following process occurs. A vertical ray from the center of the cell is intersected with the Solids. The top and bottom of the grid cell is then compared with intersected solids to determine the length of each solid within the cell. Then all of the "solid lengths" with the same material id are combined. The material id with the greatest length in the cell is assigned to the cell. If more than one material has the same length in the cell then the material with the lowest id is assigned to the cell.

Material set name

The *Material set name* is used to specify the name of the new material set as it appears in the project explorer.

Gaussian Field Generator

GMS includes an interpolation option associated with the 2D scatter point module called Gaussian Sequential Simulation (GSS). This option is used to generate a set of scalar datasets (Gaussian fields) using a Gaussian sequential simulation. This is somewhat similar to indicator kriging or T-PROGS in that it generates a set of equally probable results which exhibit heterogeneity and are conditioned to values at scatter points. However, the resulting arrays are floating point scalar datasets, rather than the integer arrays produced by T-PROGS and indicator kriging.

The results of a GSS can be used in combination with the new *Multiplier Array* option for parameters. It is now possible to associate one or more scalar datasets with an array-based parameter. When MODFLOW is executed, the parameter starting value is multiplied by the dataset to produce the input array. This makes it possible to use the results of the Gaussian sequential simulation as input for parameter fields for a stochastic (Monte Carlo) simulation.

Gaussian Simulations

The new GSS tool is based on the FIELDGEN code developed by John Doherty. John Doherty describes GSS as follows:

The process of stochastic field generation by sequential simulation is very easy to understand. At each field point an expected field value and a field standard deviation pertaining to that point are first determined. These are calculated through kriging from points to which field values have already been assigned, as well as from points at which conditioning data exists (if available). Using the expected value and standard deviation calculated in this way, a random field value is generated based on the assumption of a Gaussian probability distribution. The field value thus obtained can then be used in generating expected values and standard deviations at other field points at which field generation then takes place in the same way.

GSS is a form of Kriging but it is listed in the GMS interface as a new interpolation scheme.

This new option will differ from Kriging in the following ways:

1. GSS uses the FIELDGEN utility developed by John Doherty to perform the interpolation rather than the GSLIB code used by kriging. FIELDGEN is a modified version of the *sgsim* utility in GSLIB so many of the options are quite similar to those used for normal kriging.
2. As is the case with T-PROGS, enter the number of desired simulations and FIELDGEN produces N arrays, rather than one array.
3. It can only be used for 2D interpolation and it will only work when interpolating to 3D cell-centered grids.
4. It can work with or without a scatter point set. If a scatter point set is provided, the resulting fields are conditioned to the values at the scatter points. Otherwise define a mean and a variogram and the values are randomly generated.

Gaussian Simulation Options

The first step in setting up a GSS is to import a set of scatter points with the values to which to condition the simulation. This step can be skipped if there is no conditioning data.

The next step is to select the **Gaussian Simulation Options** command in the *Interpolation* menu in the 2D Scatter Point module. This brings up the following dialog:

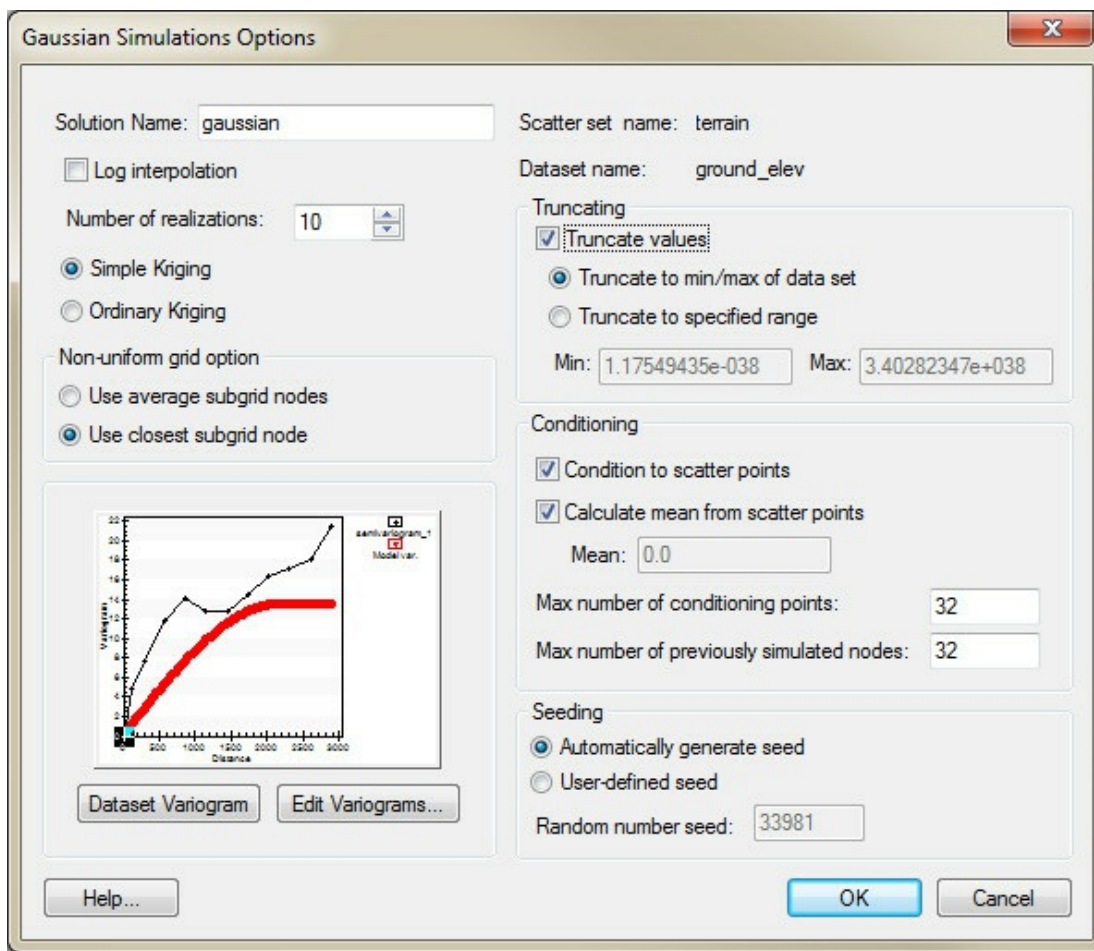

Example of the Gaussian Simulations Options dialog.

The *Solution name* at the top is the name that will be applied to the set of Gaussian fields. The *Number of realizations* item is the desired number of Gaussian fields. The original GSLIB code was designed to work with uniform grids (constant cell sizes). The *Non-uniform grid* option controls how the data are converted to a non-uniform grid (if necessary). The **Edit Variogram** button should be selected to set up a model variogram using the GMS [Variogram Editor](#). A model variogram must be defined whether or not there are scatter points for conditioning.

Running the Simulation

Once the GSS options are selected, the next step is to run the simulation. This is accomplished by selecting the **Run Gaussian Simulation** command in the *Interpolation* menu. During the simulation, a window displays the progress of the simulation:

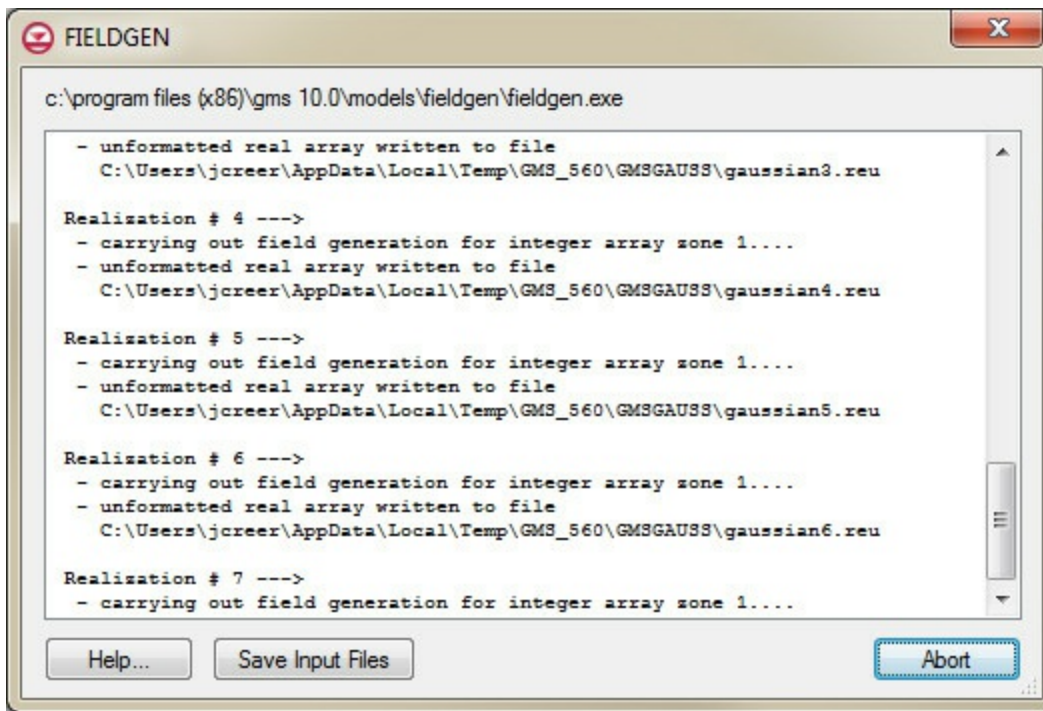



Example of the Gaussian FIELDGEN wrapper dialog.

Viewing the Results

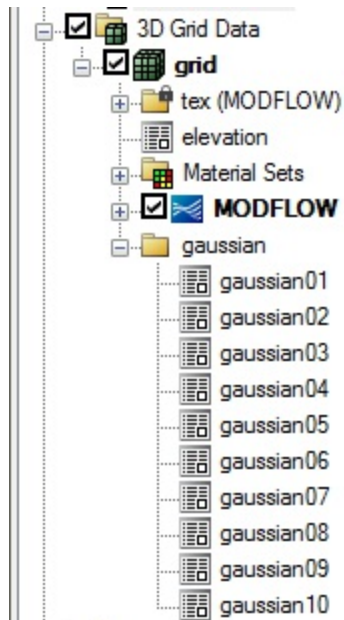
Once the simulation is finished, a new folder appears in the [Project Explorer](#) window which has the name of the simulation and contains a set of dataset arrays:



Clicking on each dataset icon  makes it the active dataset for contouring. The dataset properties can be viewed by double-clicking on the icon . The following image represents a sample Gaussian realization:

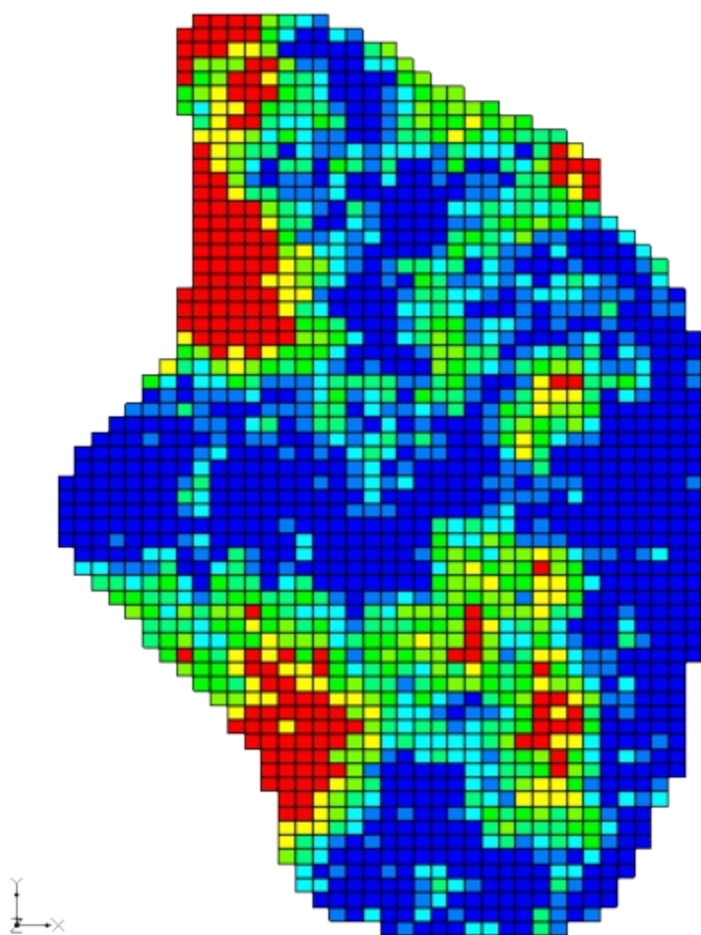

PEST Dialog

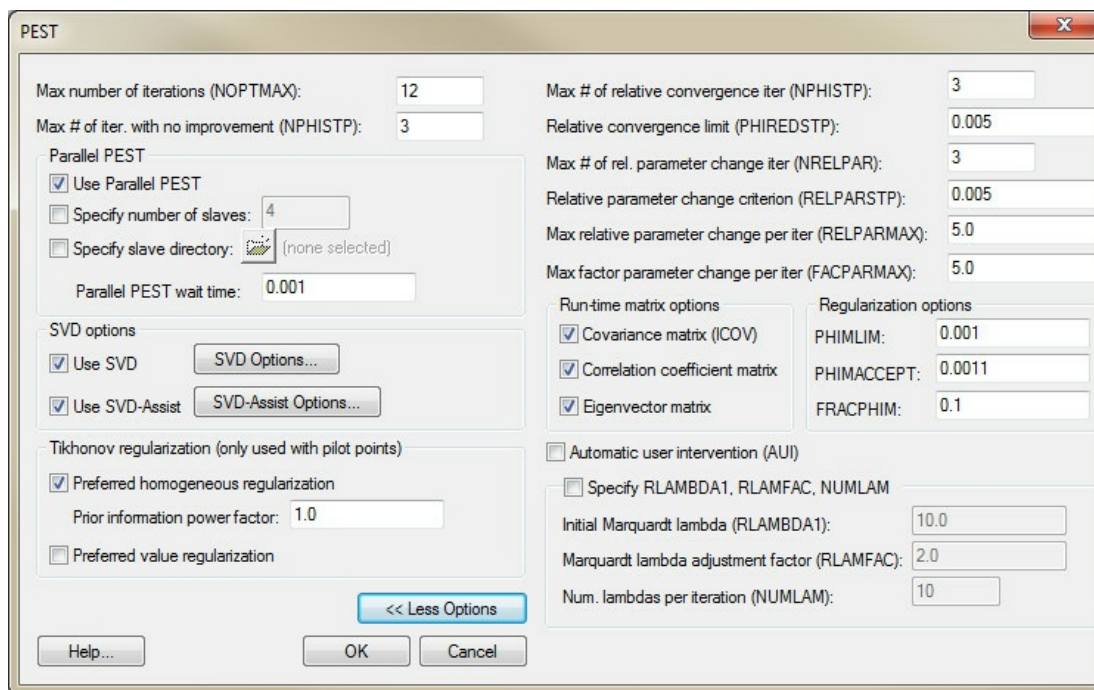

The PEST parameter estimation dialog

The *PEST* dialog (*MODFLOW* | **Parameter Estimation**) allows the editing of inverse modeling options that are specific to PEST. This dialog is available when *Parameter Estimation* option is chosen as the *Run* option in the *Global Options\Basic Package* dialog.

Max number of iterations (NOPTMAX)

This value (NOPTMAX) sets the maximum number of optimization iterations that PEST is permitted to undertake on a particular parameter estimation run. To ensure that PEST termination is triggered by other criteria, more indicative of parameter convergence to an optimal set or of the futility of further processing, set this variable very high. A value of 20 to 30 is often appropriate.

If NOPTMAX is set to 0, PEST will not calculate the Jacobian matrix. Instead it will terminate execution after just one model run. This setting can thus be used when calculating the objective function corresponding to a particular parameter set and/or to inspect

observation residuals corresponding to that parameter set.

If NOPTMAX is set to -1 , PEST will terminate execution immediately after it has calculated the Jacobian matrix for the first time. The parameter covariance, correlation coefficient and eigenvector matrices will be written to the run record file, and parameter sensitivities will be written to the sensitivity file; these are based on the initial parameter set supplied in the PEST control file.

Max number of iterations with no improvement (NPHINORED)

If PEST has failed to lower the objective function over NPHINORED successive iteration it will terminate execution. A value of 3 or 4 is often suitable for this variable.

Advanced Options

Max number of relative convergence iterations (NPHISTP); Relative convergence limit (PHIREDESTP)

If, in the course of the parameter estimation process, there have been NPHISTP optimisation iterations for which

$$(\Phi_i - \Phi_{\min}) / \Phi_i \leq \text{PHIREDESTP} \quad (4.6)$$

(Φ_i being the objective function value at the end of the i 'th optimisation iteration and Φ_{\min} being the lowest objective function achieved to date), PEST will consider that the optimisation process is at an end.

For many cases 4 and 0.01 are suitable values for NPHISTP and PHIREDESTP respectively. However, be careful not to set NPHISTP too low if the optimal values for some parameters are near or at their upper or lower bounds. In this case it is possible that the magnitude of the parameter upgrade vector may be curtailed over one or a number of optimisation iterations to ensure that no parameter value overshoots its bound. The result may be smaller reductions in the objective function than would otherwise occur.

Max number of relative parameter change iterations (NRELPAR); Relative parameter change criterion (RELPARSTP)

If the magnitude of the maximum relative parameter change between optimisation iterations is less than the Relative Parameter Change Criterion (RELPARSTP) over Max # of Relative Parameter Change Iteration (NRELPAR) successive iterations, PEST will cease execution.

All adjustable parameters, whether they are relative-limited or factor-limited, are involved in the calculation of the maximum relative parameter change. RELPARSTP is a real variable for which a value of 0.01 is often suitable. NRELPAR is an integer variable; a value of 2 or 3 is normally satisfactory.

Max relative parameter change per iteration

This (RELPARMAX) is the maximum relative change that a parameter is allowed to undergo between optimisation iterations.

Max factor parameter change per iteration (FACPARMAX)

This value is the maximum factor change that a parameter is allowed to undergo during an iteration.

Run-time matrix options

Select these options if wanting these arrays written to external files. These arrays will also be written to the PEST output file (*.rec).

Measurement obj func upper limit (PHIMLIM)

This is the upper limit of the measurement objective function (i.e., the upper level of model-to-measurement misfit) that is tolerable when trying to minimise the regularisation objective function Φ_r .

Measurement obj func accept. level (PHIMACCEPT)

This is the acceptable level for the measurement objective function that PEST uses to change its method of calculating the Marquardt Lamdas (see PEST documentation).

Normally PHIMACCEPT should be about 5% to 10% greater than PHIMLIM. However if PEST is performing well, the user may wish to make it closer to PHIMLIM than this. In choosing the best parameter set at any stage of the optimisation process (for recording in the parameter value file) PEST looks at all parameter sets for which it has carried out model runs up to that point in the process. If any of these runs have resulted in an objective function less than PHIMACCEPT, it then searches from among these runs for the parameter set which gave rise to the lowest regularisation objective function. If PHIMACCEPT is set too close to PHIMLIM, PEST's selection of the best parameter set may be restricted somewhat, for there may be some parameter sets for which the measurement objective function Φ_m is just above PHIMACCEPT but for which Φ_r is quite low. Alternatively, if PHIMACCEPT is set too large, then PEST might not try hard enough to reduce Φ_m to Φ_{mi} , preferring instead to work within the weaker constraint set by PHIMACCEPT. When working in regularisation mode, PEST prints out Φ_r and Φ_m for every parameter upgrade attempt. It will be apparent from this information whether PHIMACCEPT has been set correctly.

FRACPHIM

PEST ignores the value supplied for FRACPHIM unless it is greater than zero. A value of between zero and 1.0 (but normally less than about 0.3) can be supplied for this variable if the user is unsure what value to use for PHIMLIM. See the PEST documentation.

Automatic user intervention (AUI)

When the optimization process undertaken by PEST appears to be going nowhere, the situation can often be remedied by selectively withdrawing certain parameters (normally the most insensitive ones) from the parameter estimation process. This process has been automated in PEST using the AUI option. For more information on AUI see the PEST documentation (section 5.7 of the PEST manual).

It should be noted that use of the SVD process in PEST is usually more effective than AUI as the SVD process removes insensitive parameters.

Parallel PEST

GMS allows running PEST in parallel on a single machine to take advantage of multiple cores with the Parallel PEST Utility. This can greatly speed up the PEST runs.

- *Specify number of slaves*

"Slaves" refers to the separate processes that will be run in parallel. Specify the number of slaves or, if not specified, GMS will automatically determine the number of cores available on the machine and use that for the number of slaves.

- *Specify slave directory*

By default, GMS uses the system temp directory as the slave directory. However, a user may specify a different folder for the files that are used by the slaves. If the specified slave directory is invalid then GMS will use the system temp directory.

- *Parallel PEST wait time*

The wait time is the amount of time that PEST will pause at certain strategic places in their communication. Normally the default value should work fine. However, if either PEST reports a sharing violation on the hard drive then increase the value of the wait time.

The PEST model can also be run with parallel processing across multiple machines with setup outside of GMS with PSLAVE. More information about Parallel PEST can be found in the [PEST Manual](#) starting on page 222 from the [PEST Downloads page](#).

SVD (Singular Value Decomposition)

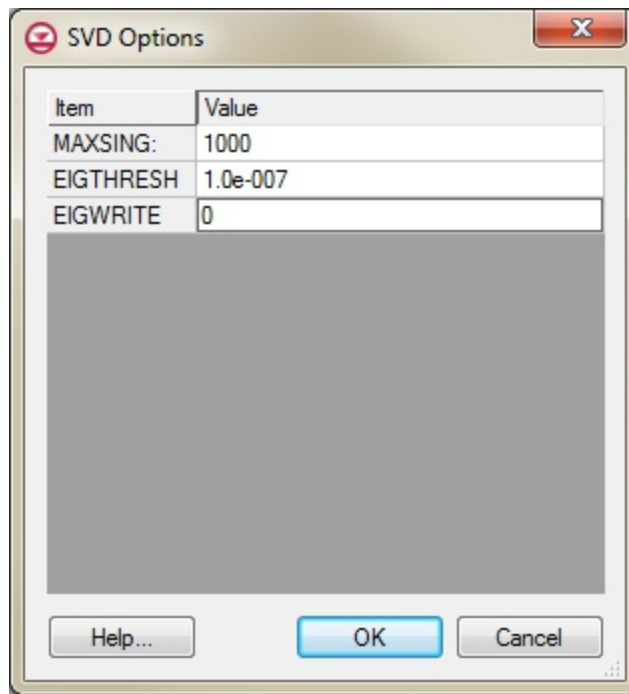

The SVD Options dialog

The *Use SVD* toggle is available to turn on the SVD functionality in PEST. For a more complete explanation of SVD, see the [PEST manual](#) in section 8.4. The inputs to the SVD process can be edited by selecting the **SVD Options** button.

The SVD process analyzes the parameters that are currently part of the parameter estimation process and removes parameters that are not helping to solve the problem. The user can limit the number of parameters used by specifying a maximum number of singular values (MAXSING) or by specifying EIGTHRESH. By default MAXSING is set to 1000 and EIGTRESH to 1E-7, so that the number of parameters will be limited by the value of EIGTHRESH.

- MAXSING – maximum number of singular values to include in the inversion process.
- EIGTHRESH – a ratio of the lowest to highest parameter eigen value (a value of 1E-7 is usually sufficient).
- EIGWRITE – controls output written to the *.svd file by PEST. When the value is 1 a more verbose file is written that can become quite large. By default the value of EIGWRITE is set to 0.

SVD-Assist

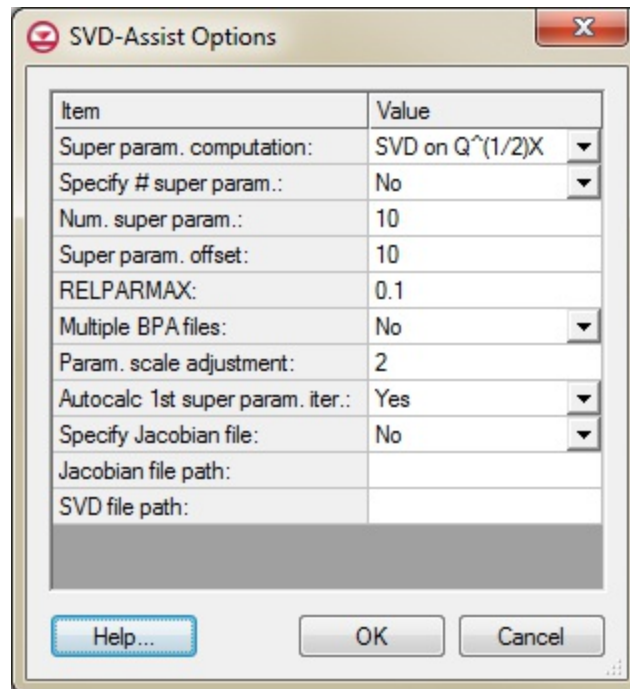

The SVD-Assist Options dialog

The *Use SVD-Assist* toggle turns on the SVD-Assist process for PEST. This process is particularly advantageous for models that have hundreds or thousands of parameters (such as pilot points). SVD-Assist involves 3 basic steps.

1. First, PEST runs MODFLOW once for every parameter in order to compute a matrix. This information is used to create super parameters that are combinations of the parameters originally specified.
2. Second, SVDAPREP is run to create a new PEST control file. The options for SVDAPREP are entered by selecting the **SVD-Assist Options** button. For more information on each of these options see the PEST manual in section 8.5.4.2. The most important option entered is the *Specify # super param* and this is set to *No* by default. When this option is set to *No*, then the information written to the *.svd file will be used to specify the number of super parameters.
3. Third, PEST runs using the new control file written by SVDAPREP. This should result in significantly fewer model runs for each PEST iteration. This often results in an order of

magnitude reduction in the number of runs required for each PEST iteration.

Tikhonov Regularization

Tikhonov Regularization (prior information for pilot points). This section of the dialog allows the user to select the method for include Tikhonov regularization in the PEST run. If neither option is turned on then regularization will not be included in the PEST run.

The first option, *Preferred homogeneous regularization*, is the option that GMS has always supported with pilot points. When using this option, prior information equations are included that impose a homogeneity constraint on the pilot points. This means that in absence of other information, pilot points that are near to one another should have about the same value.

- Prior information power factor:

This is used to change the weight applied to the prior information equations for the pilot points. A value of 1 is normally sufficient. The prior information equations impose a homogeneity constraint on the pilot points. This means that in absence of other information, pilot points that are near to one another should have about the same value. When the prior information equations are created GMS will compute an inverse distance weight between each pilot point and all other pilot points for a given parameter. This weight is then raised to the power of the *Prior information power factor* and assigned to the equation for a given pair of points. So to increase the homogeneity constraint (assign a higher weight to the prior information equation), the user should decrease this value. To decrease the homogeneity constraint (assign a lower weight to the prior information equation), the user should increase this value.

The second option, *Preferred value regularization*, is a new option beginning with GMS version 8.0. When this option is used, prior information equations are included that constrain the pilot points near their starting values. Using this option the user can give a set of starting values to the pilot points based on field data or professional judgment. PEST will only change those values if necessary to calibrate the model.

Also new in GMS 8.0, parameters of different types (HK, RCH) are put into different

regularization groups. According to John Doherty, this helps differentiate weighting amongst pertinent prior information equations.

See also

- [Model Calibration](#)

Saving and Reading a MODFLOW Simulation

After building a MODFLOW simulation, the simulation results can be saved and read into GMS.

Saving a MODFLOW Simulation

Once a MODFLOW simulation has been created and checked for potential problems with the [Model Checker](#), the next step is to save the simulation to disk and run MODFLOW. MODFLOW simulations are saved using the **Save** and **Save As** commands in the *File* menu.

Selecting the **Save** command saves the GMS project including the model simulation. By default the model simulation will be saved to the same location as the GMS project. However, in the Save dialog the path for the model simulation can be specified.

A MODFLOW simulation is actually saved to a set of input files. The MODFLOW super file is used to store extra data used by GMS but not used by MODFLOW. The super file also contains the path to the name file. The names of all of the input and output files associated with a simulation are saved in the name file. When MODFLOW is launched, the name of the super file is automatically passed to the MODFLOW executable.

When a MODFLOW simulation is saved, the names of the other MODFLOW input files are automatically patterned after the name of the super file. For example, if the super file is named sampmod.mfs, the other files are named sampmod.bas, sampmod.bcf, etc.

The user can adjust the output options in the [Output Control dialog](#)

The version of MODFLOW 2000 that ships with the GMS software has been modified to be able to read and write input data stored in HDF5 files. For more information see [MODFLOW with HDF5](#).

Reading a MODFLOW Simulation

Once a MODFLOW simulation has been saved by GMS using the **Save** command in *File* menu, the entire simulation can be read back into GMS using the **Open** command in the *File* menu.

MODFLOW simulations can be read in individually (*.mfs) or as part of a project (*.gpr). They can also be imported by using the MODFLOW name file. The extension for the name file must be changed to *.mfn.

Reading a Completed MODFLOW Solution

When using the [Model Wrapper](#) to control a MODFLOW run, use the *Read MODFLOW solution* toggle at the bottom of the dialog to automatically read in the corresponding solution.

It's also possible to read in solution files generated by MODFLOW using the **Read Solution** command in the *MODFLOW* menu. This command brings up the a file browser which prompts to choose a MODFLOW super file (pre GMS 7.0) or a MODFLOW name file (GMS 7.0+).

Standard MODFLOW Parameters

Caution

There are two ways to do MODFLOW parameterization in GMS:

1. The key value method (**recommended**)
2. The **standard MODFLOW method**

The "key value" approach is the preferred approach to defining parameters in GMS. Using key values is the only option for WEL, RIV, DRT, DRN, GHB, CHD, STR, and HFB parameters. In GMS, using the key value approach with these parameters provides the same functionality of parameter instances available in MODFLOW.

Key values can also be used with array based parameters. However, GMS does support defining array based parameters with clusters and instances (for ETS, EVT, RCH parameters).

When reading in a MODFLOW simulation that was created outside of GMS all parameters will be converted to key values so long as the parameter can be represented by key values.

Key values can not be used to represent an array based parameter if the parameter is defined using more than one cluster or more than one instance. Also, if more than one parameter uses the same zone array with a matching IZ value then the parameter can not be represented using key values. Further, if the multiplier array associated with the parameter has values other than 1.0 in the zones where the parameter is used then the parameter can not be represented with key values.

The **standard MODFLOW method** is considered an "advanced" feature in GMS. ***Only users that understand how MODFLOW uses parameters should attempt to use this feature.***

This article describes how to use the standard MODFLOW parameterization method in

GMS.

Support in GMS

Reading

GMS can read MODFLOW models that use standard MODFLOW parameters.

Writing

GMS writes MODFLOW models using the key value approach. So, although GMS can read models that use standard MODFLOW parameters, it cannot write them using the standard MODFLOW parameter method. Writing is usually done using the key value method. There are a few exceptions which include recharge and evapotranspiration parameter instances, and LPF and HUF parameter clusters. GMS will write these parameters using the standard MODFLOW parameter method because these cannot always be represented using the key value method.

Editing

When GMS reads a model that uses standard MODFLOW parameters it converts them to regular GMS key value approach parameters. The parameters can then be edited using the *Parameters* Dialog. Recharge, evapotranspiration, LPF, and HUF parameters are special in that you can edit the instance and cluster information associated with these types of parameters.

MODFLOW Parameter Clusters Dialog

The *MODFLOW Parameter Clusters* dialog accessed from the **Parameters** command in the *MODFLOW* menu allows defining instances for RCH, EVT, LPF, and HUF parameters that use clusters. The starting value for the first iteration and minimum and maximum values for each parameter can be modified. The inputs in this dialog basically follow the necessary inputs for defining a parameter instance in a package file. You may wish to review the [MODFLOW Parameter Clusters and Instances](#) section below.

Array based parameters are defined using clusters. A cluster is a multiplier array, a zone array, and specified zone values where the parameter is applied. Multiplier arrays and zone arrays have associated datasets underneath the three dimensional grid in the Project Explorer.

Instances are enabled for RCH and EVT parameters. Instances allow defining multiple sets of clusters that are all tied to one parameter. Then use different instances in different stress periods in their MODFLOW model. For more information on parameter instances consult the MODFLOW documentation.

In the *MODFLOW Parameters* dialog, select the **Define clusters** option for a parameter. This will allow specifying the number of instances and clusters that are used to define the parameter.

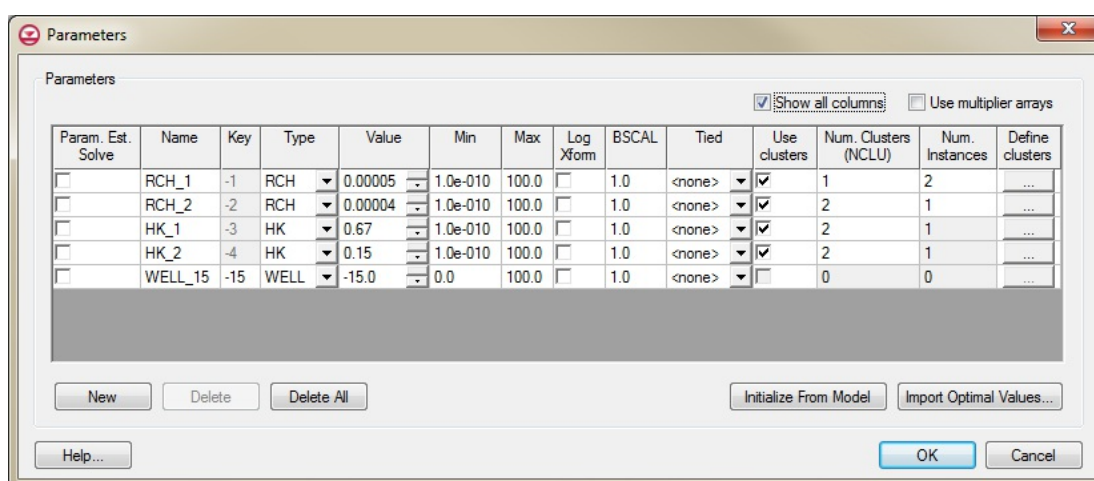

Example of the MODFLOW Parameters dialog.

In the *Define Clusters* dialog define a name for each parameter instance for RCH and EVT parameters. For LPF parameters a level is defined and for HUF parameters a hydrogeologic unit is defined. Then, for each cluster, select a multiplier array and a zone array. These are [datasets](#) on the 3D Grid. Also specify the zone values (IZ) where the parameter is to be applied in the model. If there is more than one IZ value for the cluster then enter the numbers with spaces between the entries. So if the parameter is to be applied where the zone array values are 1 and 3 then enter "1 3". Also specify the stress periods where an instance is to be used. The numbers entered in the Stress Periods field should also be space delimited. This means if you want an instance to be used in stress

periods 1, 2, and 5 then your entry in the Stress Periods field should be "1 2 5".

When the package is written out for MODFLOW the instances will be included in the parameter definition and used for forward runs or for parameter estimation runs.

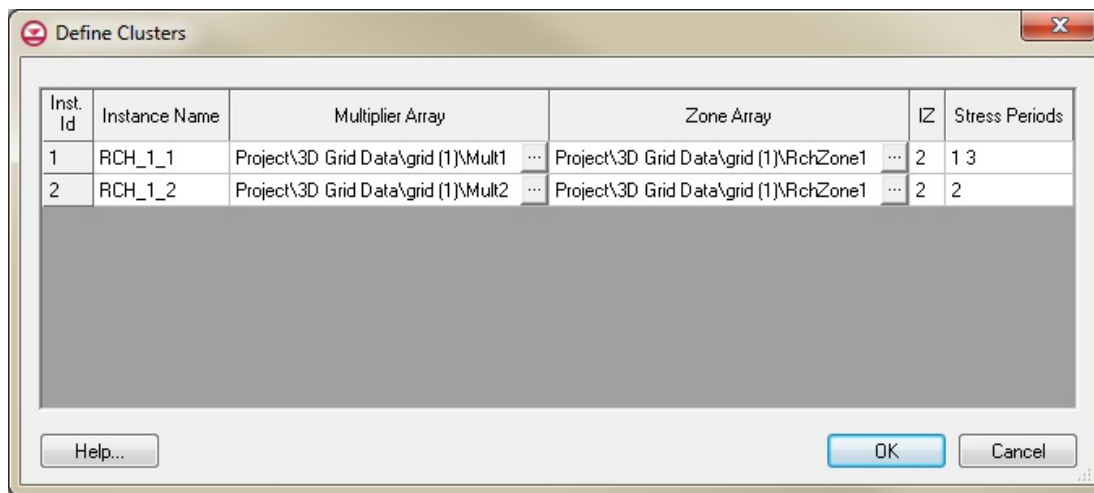

Example the Define Clusters dialog.

MODFLOW Parameter Clusters and Instances

For those wanting to follow the standard MODFLOW approach to parameterization, the following explanation may be helpful. You should refer to the MODFLOW documentation for more information.

Definitions

Here is a brief review of the most important terms used when dealing with parameters.

- *Parameter* – Has a name, type, one or more clusters, and zero or more instances.
- *Parval* – The value of the parameter.
- *Cluster* – Has a multiplier array (*Mltarr*), a zone array (*Zonarr*), and zone numbers (*IZ*).
- *Mltarr* – Name of the multiplier array. Parval is multiplied by this to define the value.
- *Zonarr* – Name of the zone array used to define the cells that are associated with a parameter.

- *IZ* – Up to 10 zone numbers (separated by spaces) that define the cells that are associated with a parameter.
- *Instance* – Parameter cluster that could be used for different stress periods in a MODFLOW simulation.

Examples

Below are some examples showing different ways parameters can be used. The examples use parameters to define recharge for a forward run (not doing inverse modeling). The grid in the examples is 5 rows, 5 columns, 1 layer. The examples use the following multiplier and zone arrays.

Multiplier arrays

MULT0001					MULT0002				
1.0	1.0	1.0	1.0	1.0	0.5	0.5	0.5	0.5	0.5
1.0	1.0	1.0	1.0	1.0	0.5	0.5	0.5	0.5	0.5
1.0	1.0	1.0	1.0	1.0	0.5	0.5	0.5	0.5	0.5
1.0	1.0	1.0	1.0	1.0	0.5	0.5	0.5	0.5	0.5
1.0	1.0	1.0	1.0	1.0	0.5	0.5	0.5	0.5	0.5

Zone Arrays

ZONE0001					ZONE0002					ZONE0003				
2	2	2	0	0	3	3	3	3	3	0	0	0	0	0
2	2	2	0	0	3	3	3	3	3	0	0	6	7	0
2	2	2	0	0	4	4	4	4	4	0	0	6	7	0
0	0	0	0	0	4	4	4	4	4	0	0	0	0	0
0	0	0	0	0	5	5	5	5	5	0	0	0	0	0

Example 1

Steady state. 1 recharge parameter with 1 cluster, 1 instance.

Recharge file	Variables	Explanations
PARAMETER 1	PARAMETER NPRCH	One recharge parameter will be used
3 40	NRCHOP IRCHCB	Apply to highest active cell, save CCF to unit 40
Param1 RCH 0.00005 1	PARNAM PARTYP Parval NCLU	Parameter name, type, value and number of clusters
MULT0001 ZONE0001 2	Mltarr Zonarr IZ	Multiplier array, zone array, and zone number
1 1	INRECH INIRCH	One parameter used in current stress period, INIRCH (ignored)
Param1	Pname	Name of parameter used to define RECH in this stress period

Results

The resulting recharge applied to the top-most active layer would be:

0.00005	0.00005	0.00005	0	0
0.00005	0.00005	0.00005	0	0
0.00005	0.00005	0.00005	0	0
0	0	0	0	0
0	0	0	0	0

Example 2

Steady state. 2 recharge parameters:

- the first with 1 cluster, 1 instance
- the second with 2 clusters, 1 instance.

Recharge file	Variables	Explanations
PARAMETER 2	PARAMETER NPRCH	Two recharge parameters will be used
3 40	NRCHOP IRCHCB	Apply to highest active cell, save CCF to unit 40
Param1 RCH 0.00005 1	PARNAM PARTYP Parval NCLU	Parameter name, type, value and number of clusters
MULT0001 ZONE0001 2	Mltarr Zonarr IZ	Multiplier array, zone array, and zone number
Param2 RCH 0.00004 2	PARNAM PARTYP Parval NCLU	Parameter name, type, value and number of clusters
MULT0002 ZONE0002 4 5	Mltarr Zonarr IZ	Multiplier array, zone array, and zone numbers
MULT0002 ZONE0003 6 7	Mltarr Zonarr IZ	Multiplier array, zone array, and zone numbers
2 1	INRECH INIRCH	Two parameters used in current stress period, INIRCH (ignored)
Param1	Pname	Name of parameter used to define RECH in this stress period
Param2	Pname	Name of parameter used to define RECH in this stress period

Results

The intermediate results for each parameter cluster are listed below:

Param1					Param2, cluster 1					Param2, cluster 2				
0.00005	0.00005	0.00005	0	0	0	0	0	0	0	0	0	0	0	0
0.00005	0.00005	0.00005	0	0	0	0	0	0	0	0	0	0.00002	0.00002	0
0.00005	0.00005	0.00005	0	0	0.00002	0.00002	0.00002	0.00002	0.00002	0.00002	0.00002	0	0.00002	0
0	0	0	0	0	0.00002	0.00002	0.00002	0.00002	0.00002	0.00002	0.00002	0	0	0
0	0	0	0	0	0.00002	0.00002	0.00002	0.00002	0.00002	0.00002	0.00002	0	0	0

The final result after accumulating each cluster is:

0.00005	0.00005	0.00005	0	0
0.00005	0.00005	0.00007	0.00002	0
0.00007	0.00007	0.00009	0.00004	0.00002
0.00002	0.00002	0.00002	0.00002	0.00002
0.00002	0.00002	0.00002	0.00002	0.00002

Example 3

Transient. 1 recharge parameter with 1 cluster, 2 instances. One instance is used in the first and third stress periods, and the other is used in the second stress period.

Recharge file	Variables	Explanations
PARAMETER 1	PARAMETER NPRCH	One recharge parameters will be used
3 40	NRCHOP IRCHCB	Apply to highest active cell, save CCF to unit 40
Param1 RCH 0.00005 1 INSTANCES 2	PARNAM PARTYP Parval NCLU INSTANCES NUMINST	Parameter name, type, value number of clusters, number of instances
Instance1	INSTNAM	Instance name
MULT0001 ZONE0001 2	Mltarr Zonarr IZ	Multiplier array, zone array, and zone number
Instance2	INSTNAM	Instance name
MULT0002 ZONE0001 2	Mltarr Zonarr IZ	Multiplier array, zone array, and zone number
1 1	INRECH INIRCH	One parameters used in current stress period, INIRCH (ignored)
Param1 Instance1	Pname Iname	Name of parameter and name of instance used in this stress period
1 1	INRECH INIRCH	One parameters used in current stress period, INIRCH (ignored)
Param1 Instance2	Pname Iname	Name of parameter and name of instance used in this stress period
1 1	INRECH INIRCH	One parameters used in current stress period, INIRCH (ignored)
Param1 Instance1	Pname Iname	Name of parameter and name of instance used in this stress period

Results

The intermediate results for each parameter cluster are listed below:

Stress Period 1, Param1, Instance RCH_1_1				
0.00005	0.00005	0.00005	0	0
0.00005	0.00005	0.00005	0	0
0.00005	0.00005	0.00005	0	0
0	0	0	0	0
0	0	0	0	0

Stress Period 2, Param1, Instance RCH_1_2				
0.000025	0.000025	0.000025	0	0
0.000025	0.000025	0.000025	0	0
0.000025	0.000025	0.000025	0	0
0	0	0	0	0
0	0	0	0	0

Stress Period 3, Param1, Instance RCH_1_1				
0.00005	0.00005	0.00005	0	0
0.00005	0.00005	0.00005	0	0
0.00005	0.00005	0.00005	0	0
0	0	0	0	0
0	0	0	0	0